



US00D744334S

(12) **United States Design Patent**  
**Merchant et al.**

(10) **Patent No.:** **US D744,334 S**  
(45) **Date of Patent:** **\*\* Dec. 1, 2015**

(54) **OVER THE COUNTER MEDICINAL CONTAINER WITH SURFACE ORNAMENTATION**

(71) Applicant: **The Procter & Gamble Company**, Cincinnati, OH (US)

(72) Inventors: **Jennifer Marie Merchant**, Cincinnati, OH (US); **Jean Martin Campbell**, Cincinnati, OH (US); **Scott Cunningham**, Cincinnati, OH (US); **Kevin Wimmer**, Union Township, OH (US)

(73) Assignee: **The Procter & Gamble Company**, Cincinnati, OH (US)

(\*\*) Term: **14 Years**

(21) Appl. No.: **29/488,235**

(22) Filed: **Apr. 17, 2014**

**Related U.S. Application Data**

(62) Division of application No. 29/471,759, filed on Nov. 5, 2013, now Pat. No. Des. 706,630.

(51) **LOC (10) Cl.** ..... **09-07**

(52) **U.S. Cl.**  
USPC ..... **D9/434**

(58) **Field of Classification Search**  
USPC ..... D9/748, 713, 702, 652, 600, 457, 434, D9/433, 414, 415; D20/40, 29, 28, 27, 23, D20/22, 10; 224/906; 206/784, 525, 525.1, 206/461, 457, 458

CPC ..... A61J 1/00  
See application file for complete search history.

(56) **References Cited**

**U.S. PATENT DOCUMENTS**

D357,861 S \* 5/1995 Sawa et al. .... D9/432  
D522,856 S \* 6/2006 Hamuro et al. .... D9/432

(Continued)

*Primary Examiner* — Randall Gholson

(74) *Attorney, Agent, or Firm* — Alexandra S. Anoff

(57) **CLAIM**

The ornamental design for an over the counter medicinal container with surface ornamentation, as shown and described.

**DESCRIPTION**

The patent or application file contains at least one drawing executed in color. Copies of this patent or patent application publication with color drawings will be provided by the Office upon request and payment of the necessary fee.

FIG. 1 is a perspective view of a first embodiment of an over the counter medicinal container with surface ornamentation embodying our new design;

FIG. 2 is a front view thereof;

FIG. 3 is a left side view thereof;

FIG. 4 is a right side view thereof;

FIG. 5 is a rear view thereof;

FIG. 6 is a top view thereof;

FIG. 7 is a bottom view thereof;

FIG. 8 is a perspective view of a second embodiment of an over the counter medicinal container with surface ornamentation embodying our new design;

FIG. 9 is a front view thereof;

FIG. 10 is a left side view thereof;

FIG. 11 is a right side view thereof;

FIG. 12 is a rear view thereof;

FIG. 13 is a top view thereof;

FIG. 14 is a bottom view thereof;

FIG. 15 is a perspective view of a third embodiment of an over the counter medicinal container with surface ornamentation embodying our new design;

FIG. 16 is a front view thereof;

FIG. 17 is a left side view thereof;

FIG. 18 is a right side view thereof;

FIG. 19 is a rear view thereof;

FIG. 20 is a top view thereof; and,

FIG. 21 is a bottom view thereof.

Broken lines show unclaimed subject matter only and form no part of the claimed design. In FIG. 1-3, the stippling represents color contrast.

**1 Claim, 9 Drawing Sheets**  
**(4 of 9 Drawing Sheet(s) Filed in Color)**

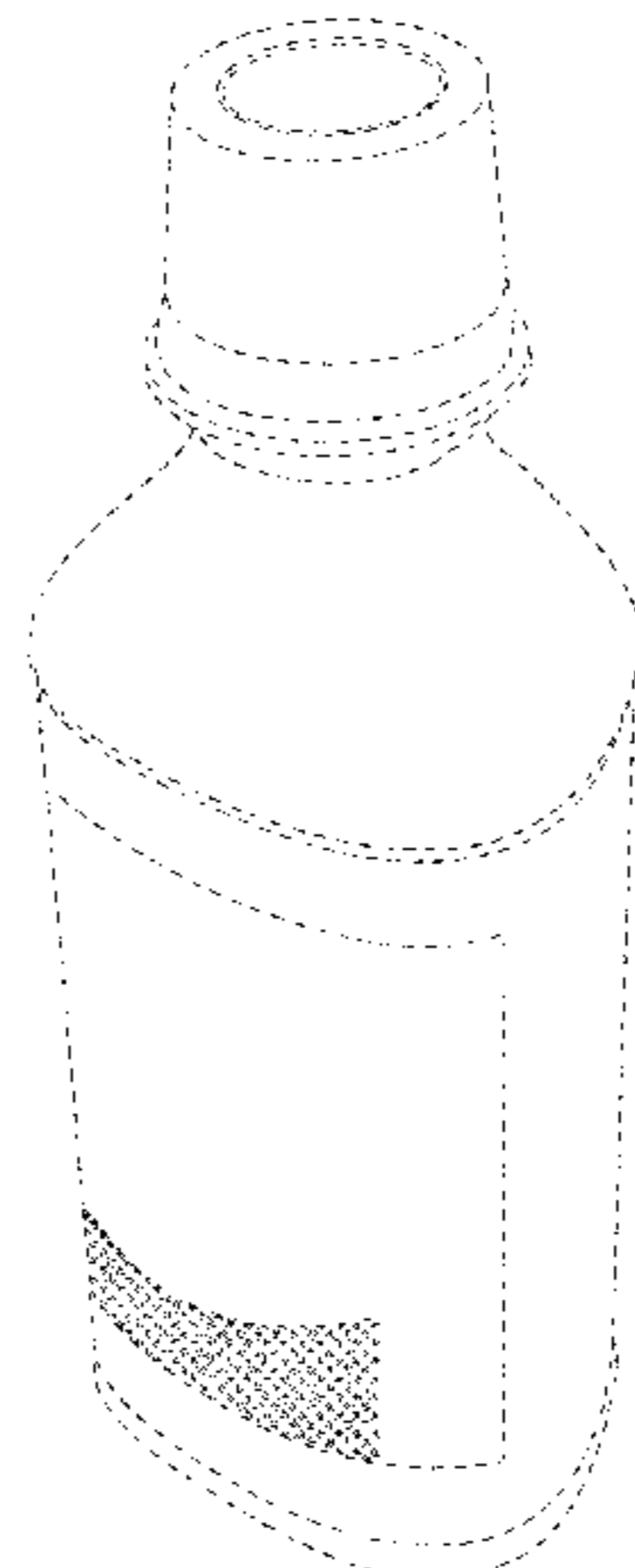

# US D744,334 S

Page 2

---

(56)

## References Cited

### U.S. PATENT DOCUMENTS

D527,253 S \* 8/2006 Hamuro et al. .... D9/432  
D608,636 S \* 1/2010 Seol ..... D9/432  
D634,621 S \* 3/2011 Edwards ..... D9/432  
D650,273 S \* 12/2011 Tekulve et al. .... D9/432

D703,532 S \* 4/2014 Merchant et al. .... D9/434  
D703,533 S \* 4/2014 Merchant et al. .... D9/434  
D705,056 S \* 5/2014 Gagliardo et al. .... D9/434  
D706,630 S \* 6/2014 Merchant et al. .... D9/434  
D707,122 S \* 6/2014 Merchant et al. .... D9/434

\* cited by examiner

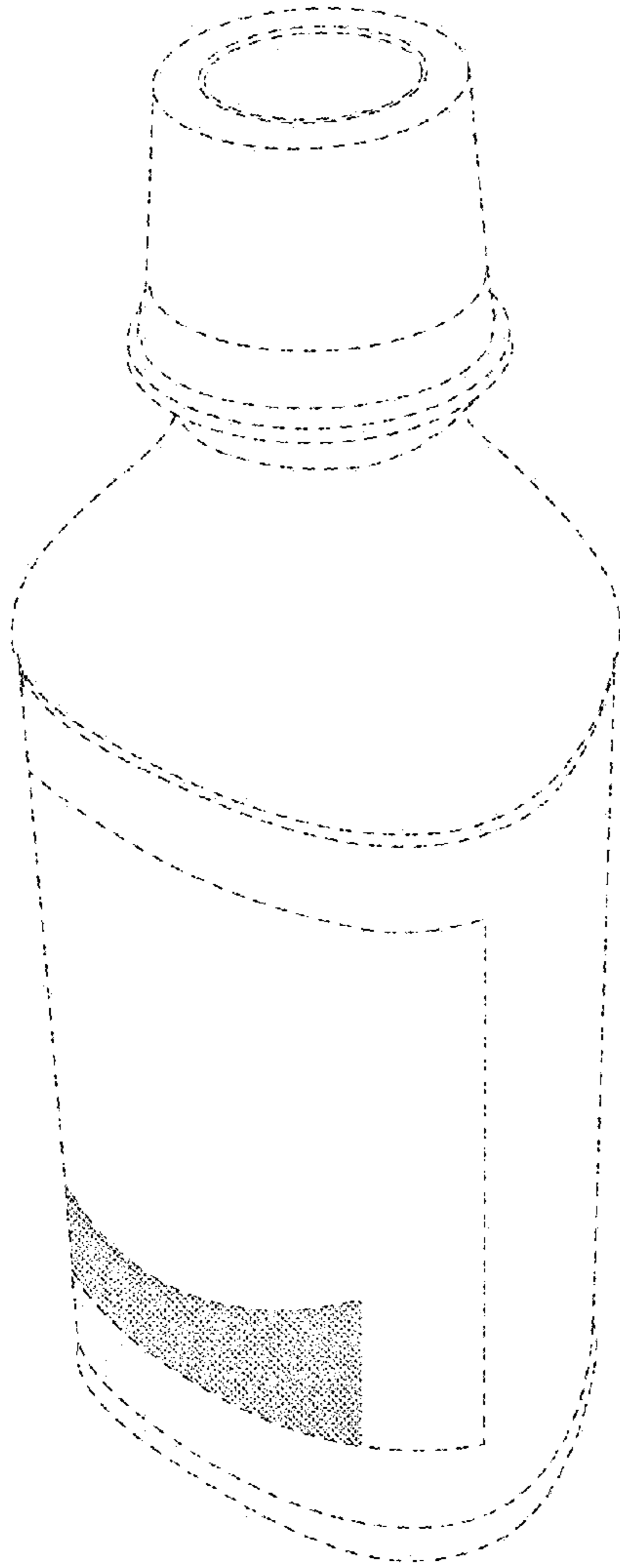

Fig. 1

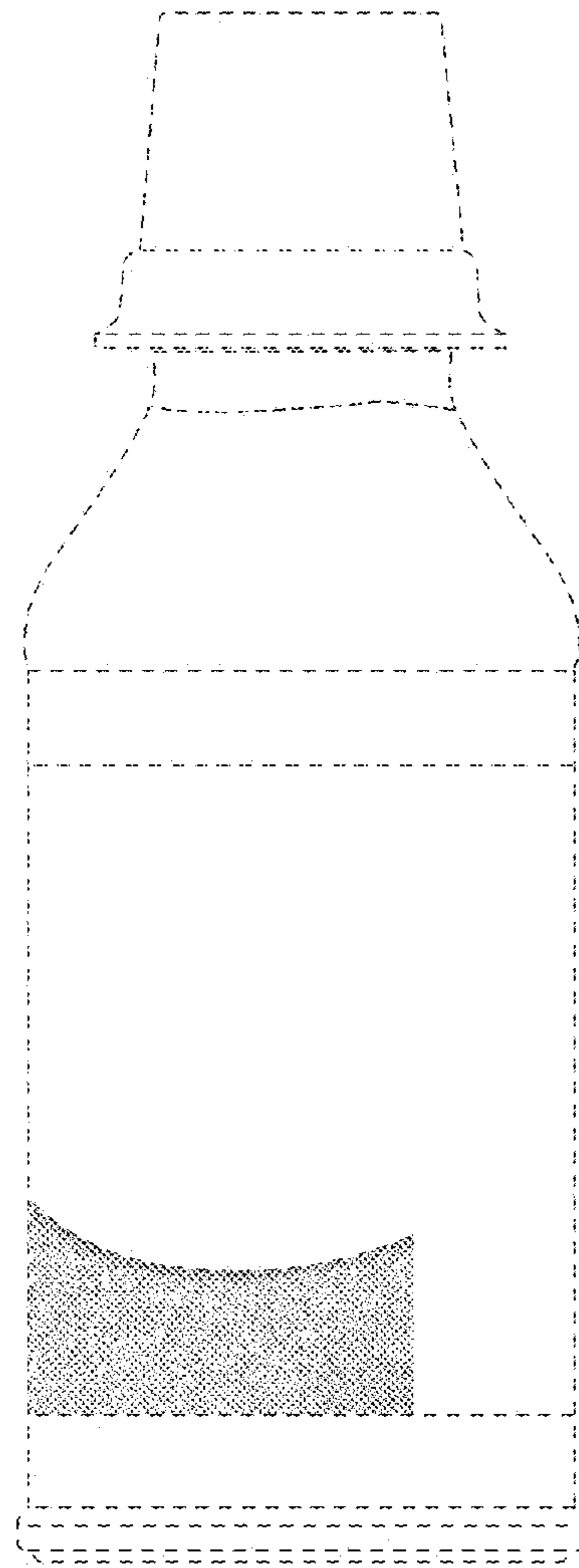

Fig. 2

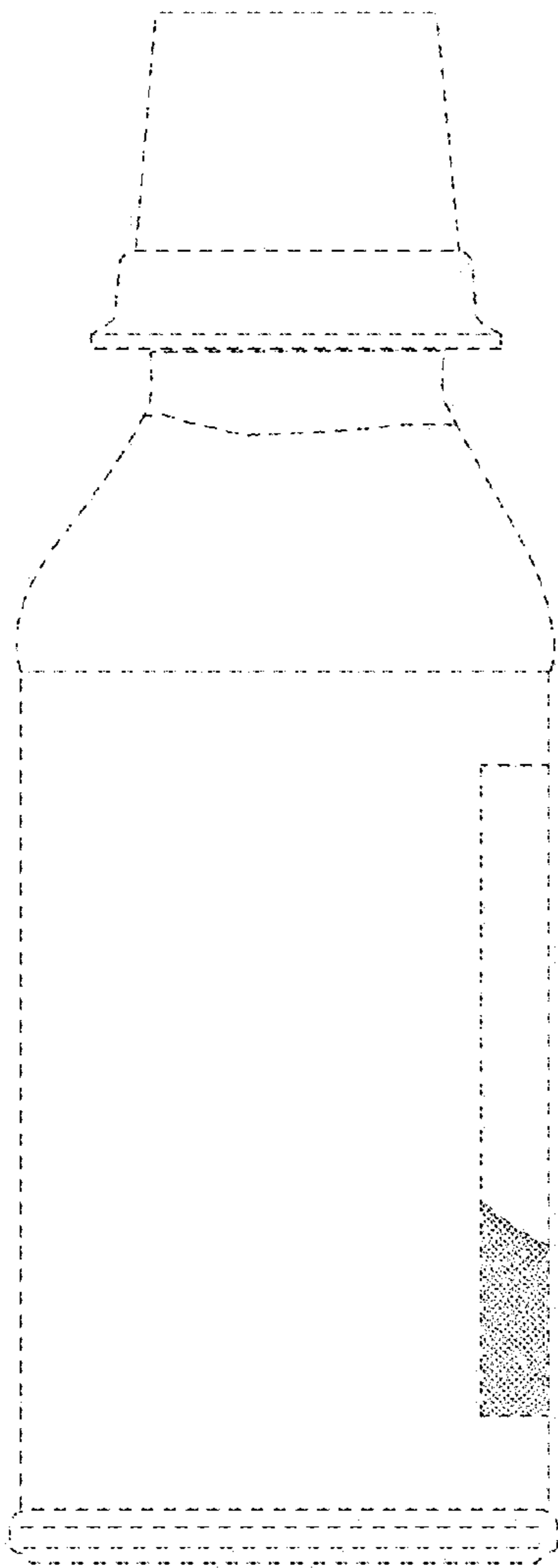

Fig. 3

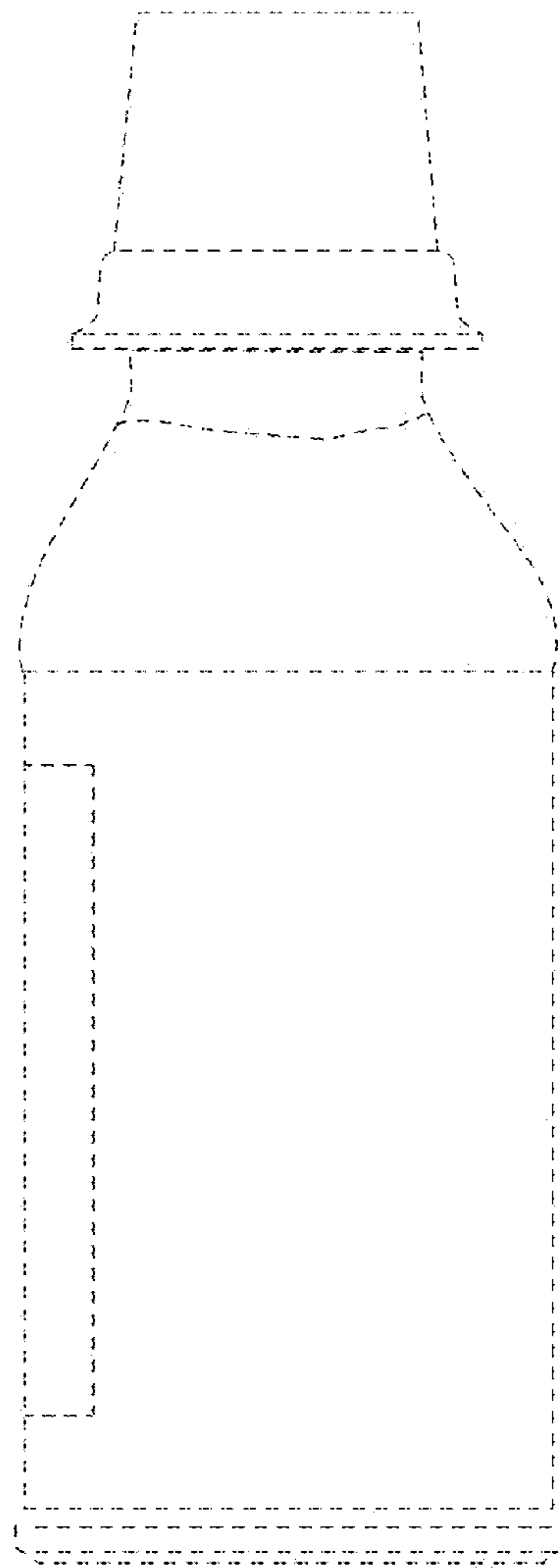

Fig. 4

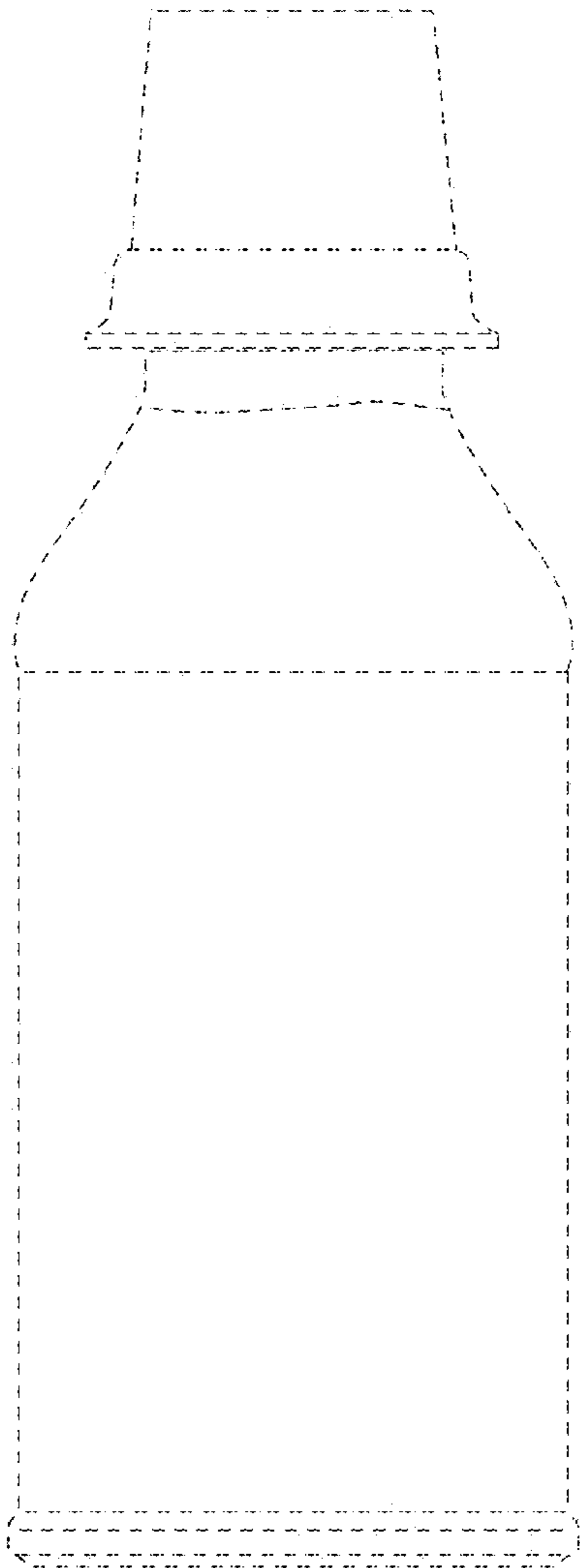

Fig. 5

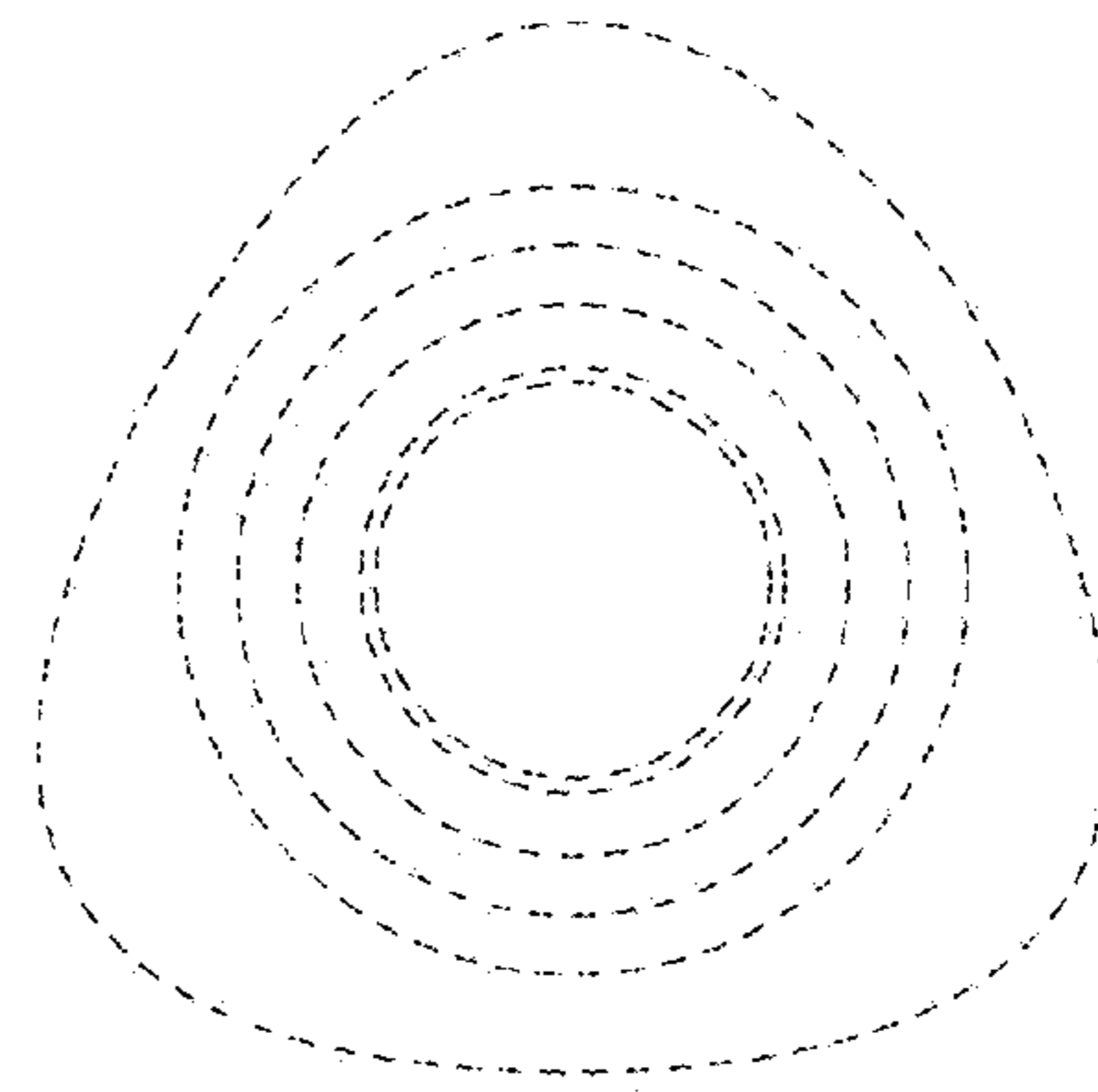

Fig. 6

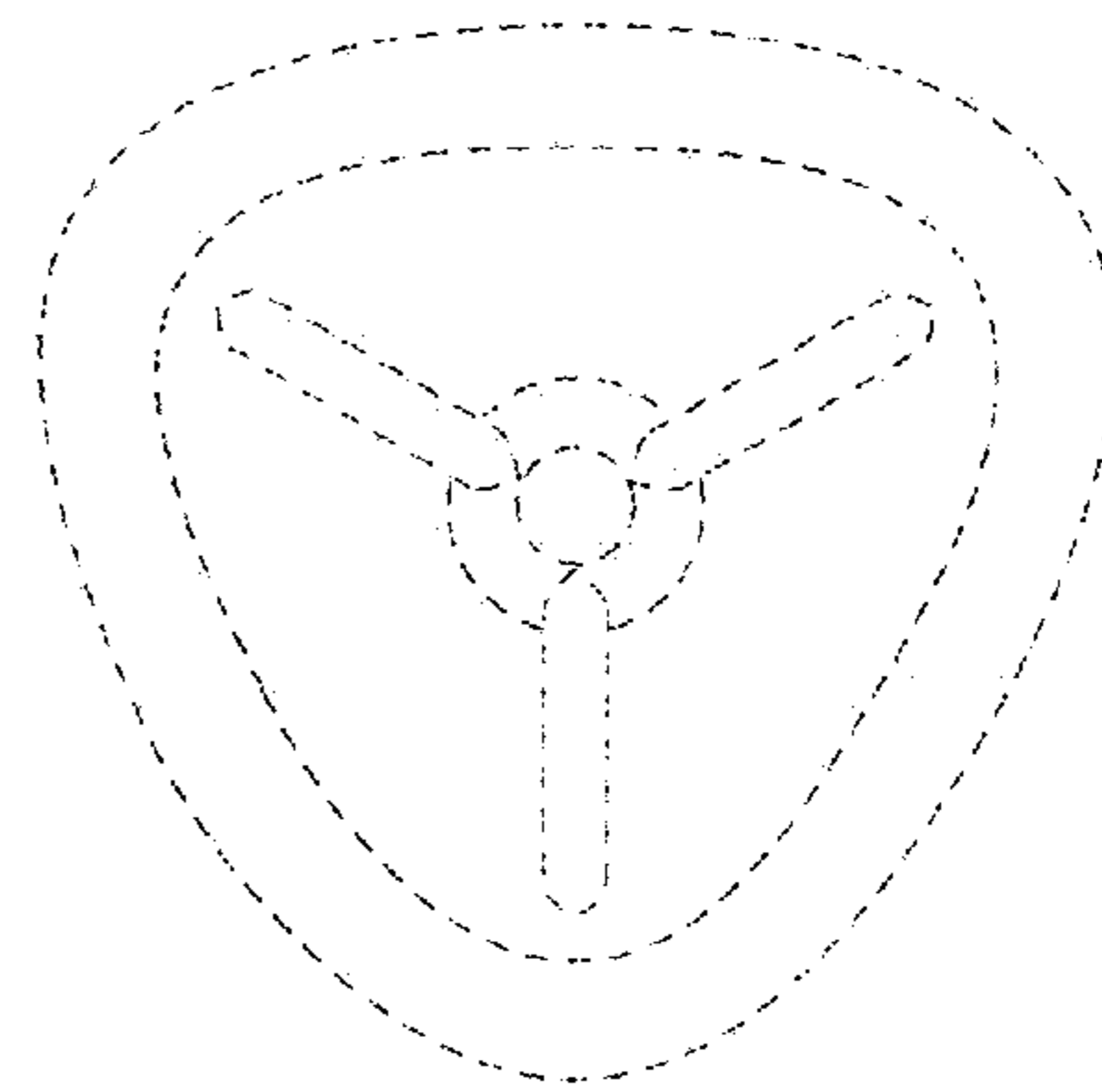

Fig. 7

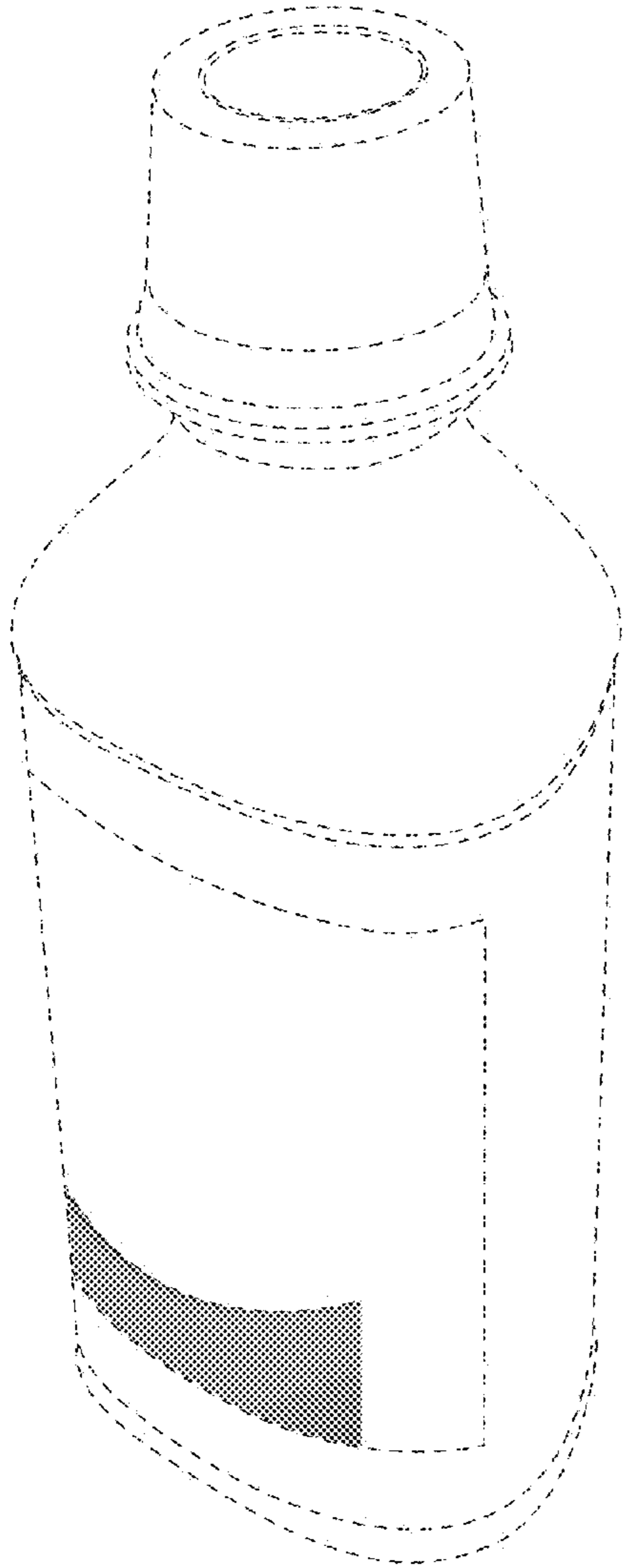

Fig. 8

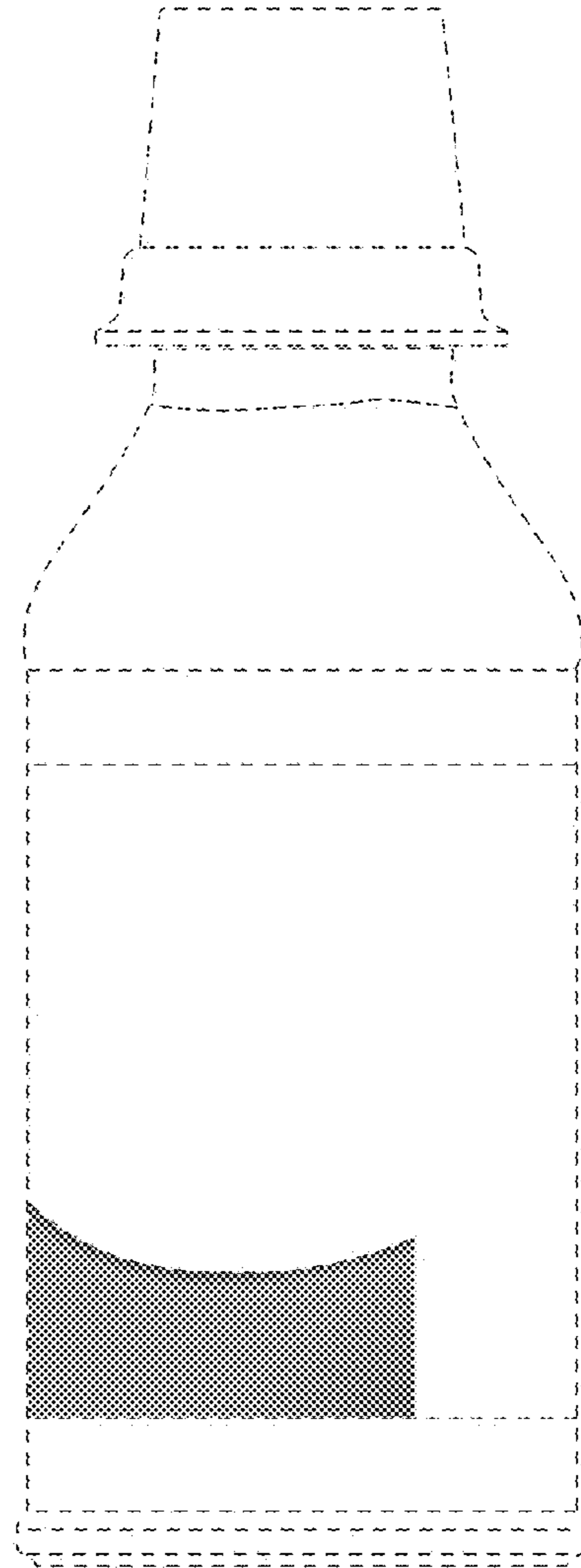

Fig. 9

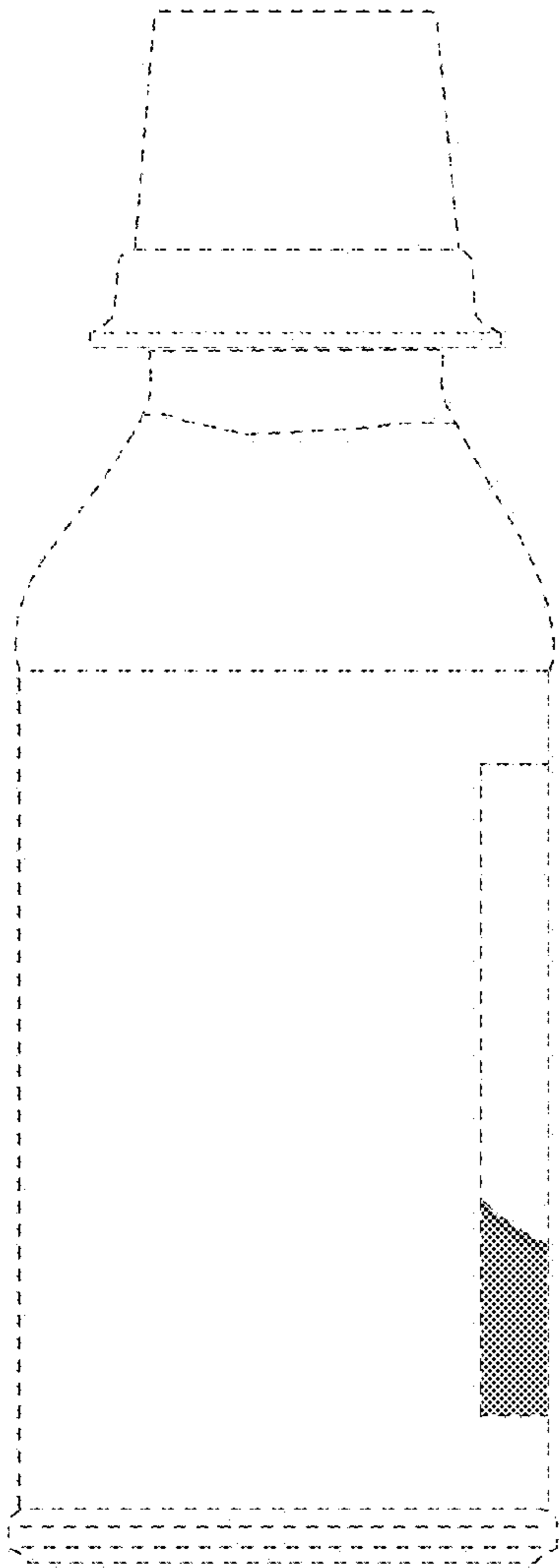

Fig. 10

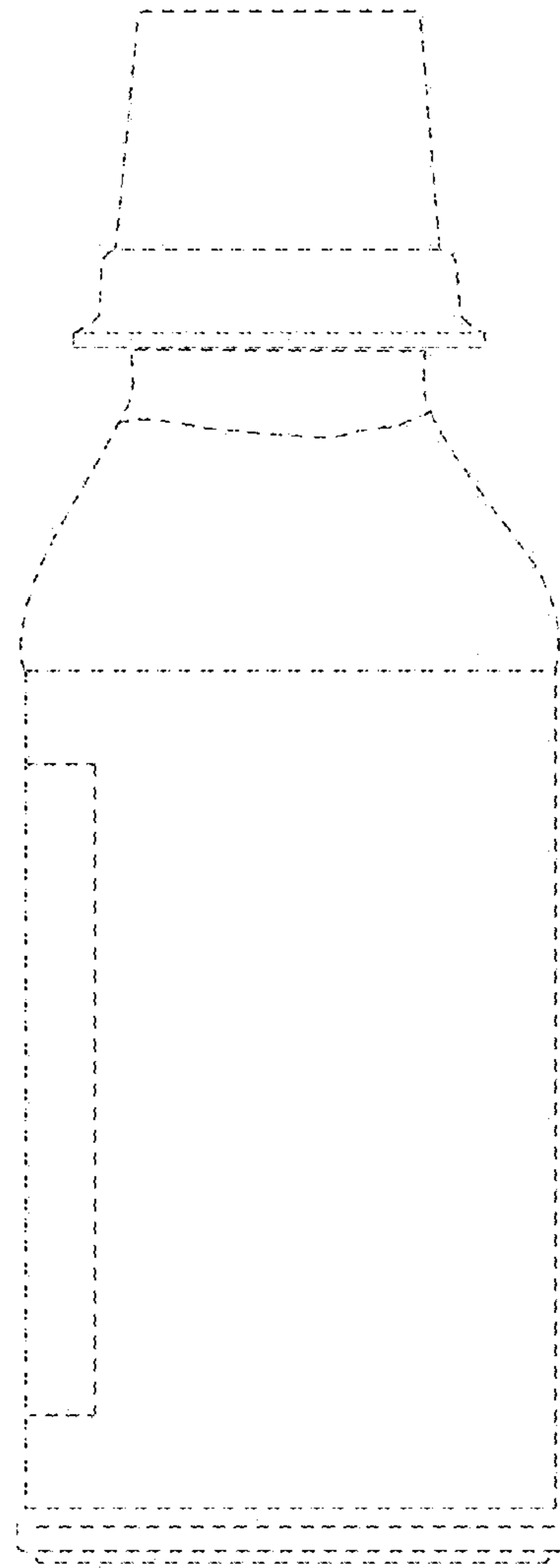

Fig. 11



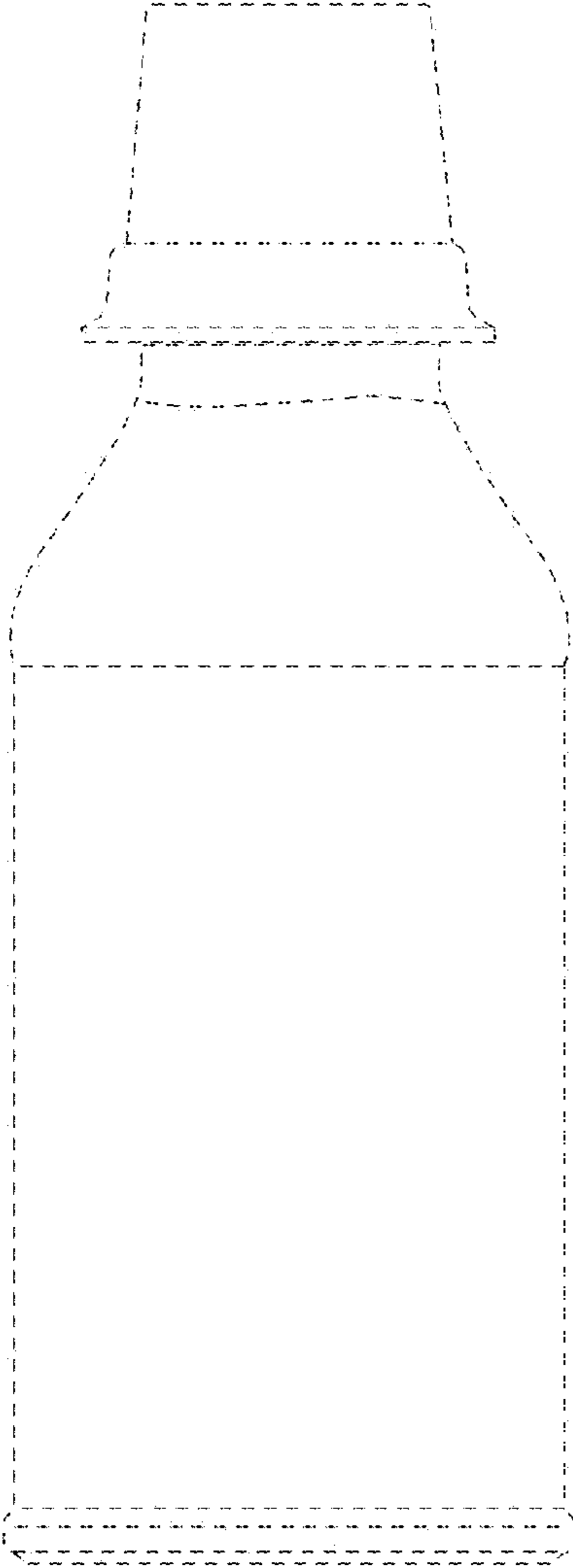

Fig. 12

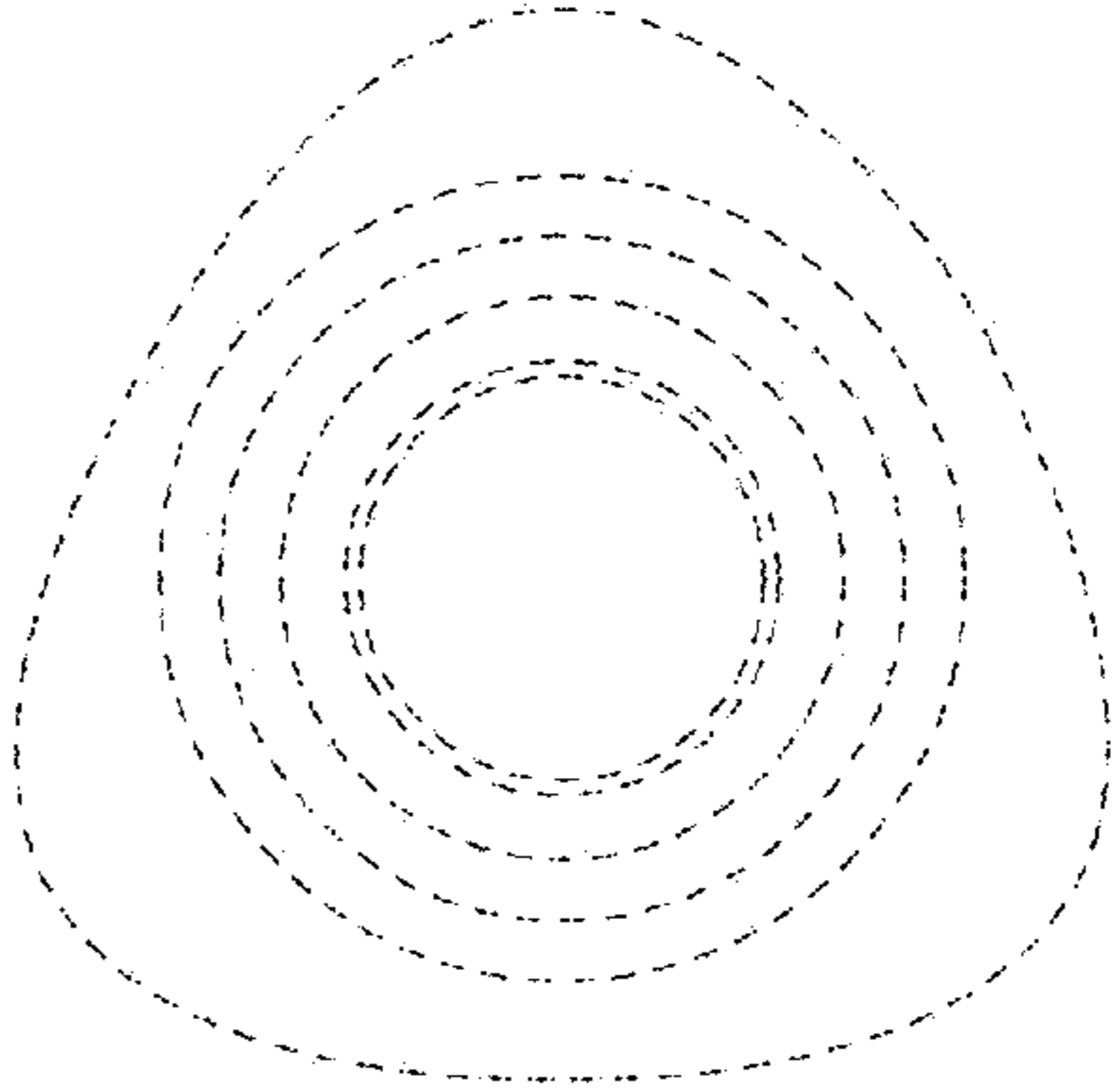

Fig. 13

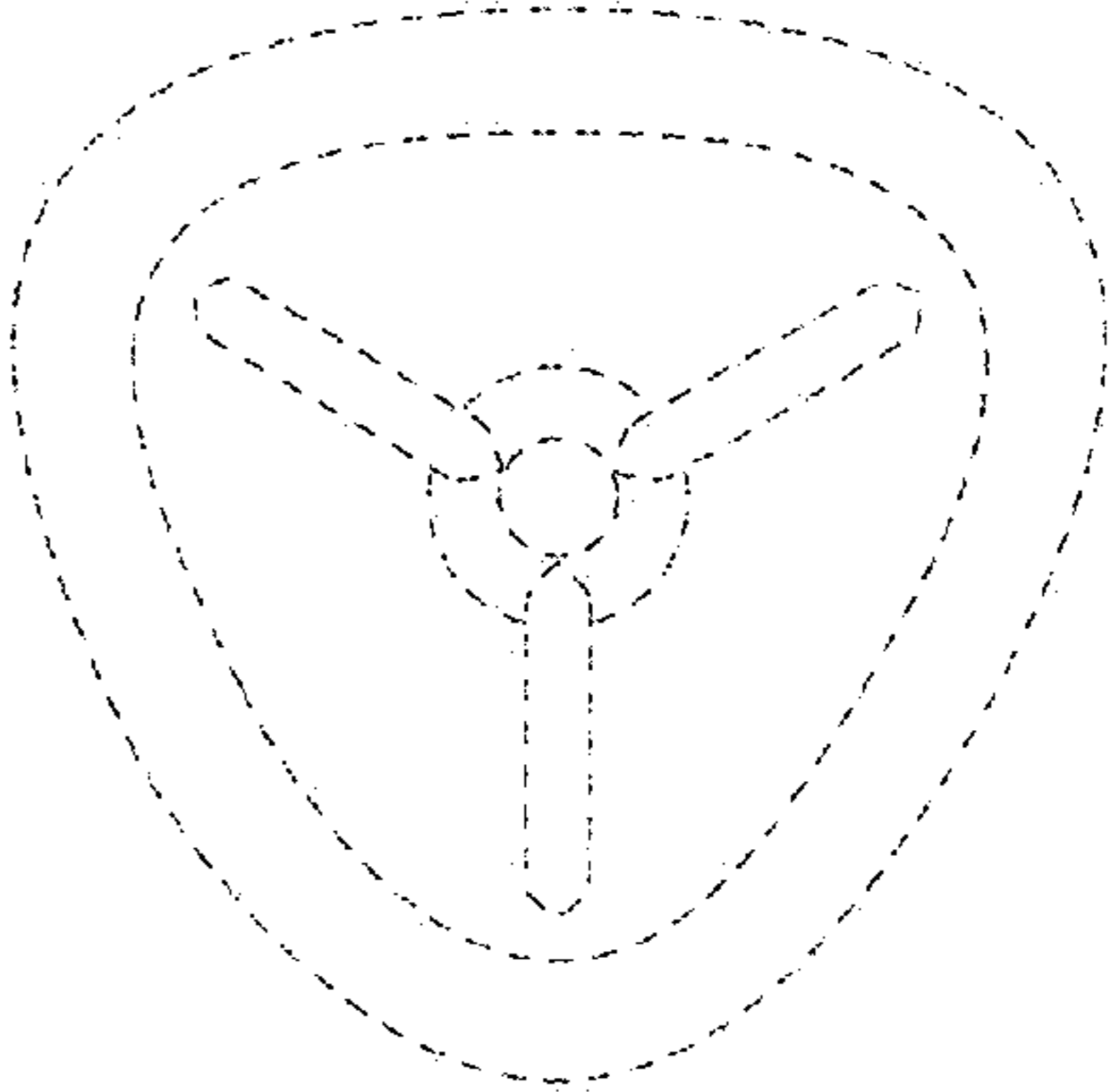

Fig. 14



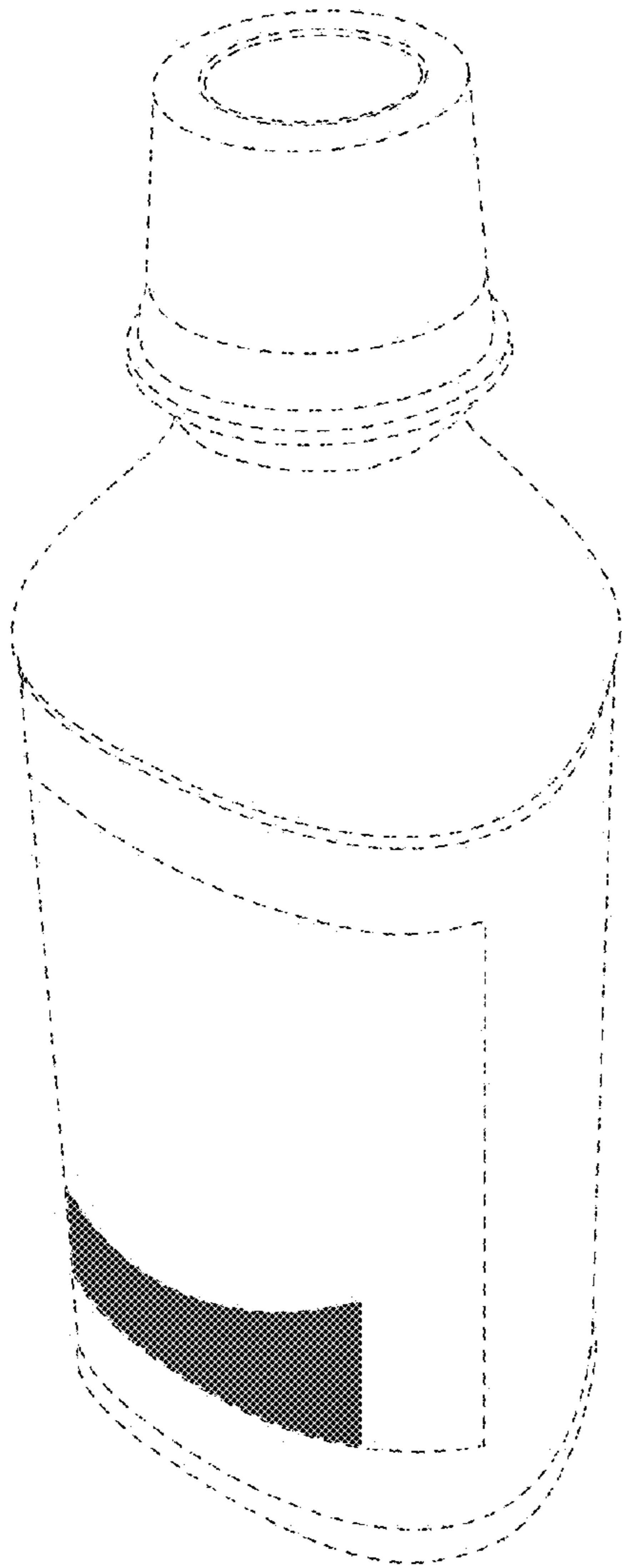

Fig. 15

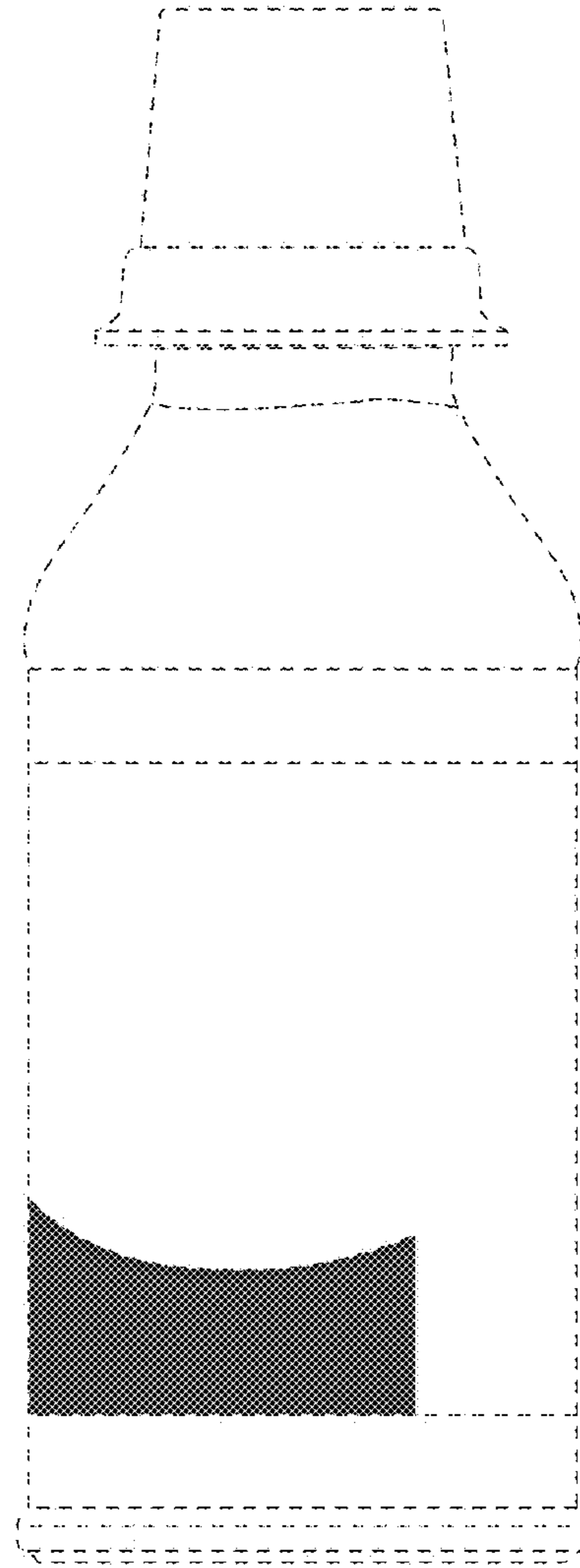

Fig. 16

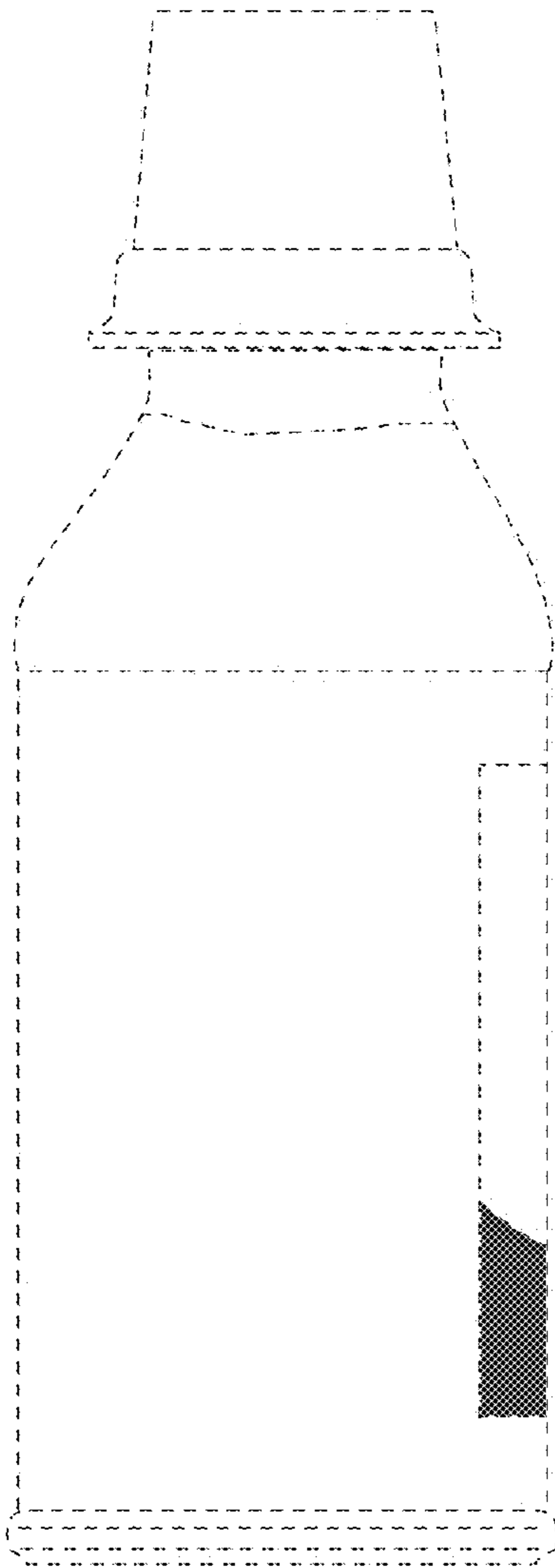

Fig. 17

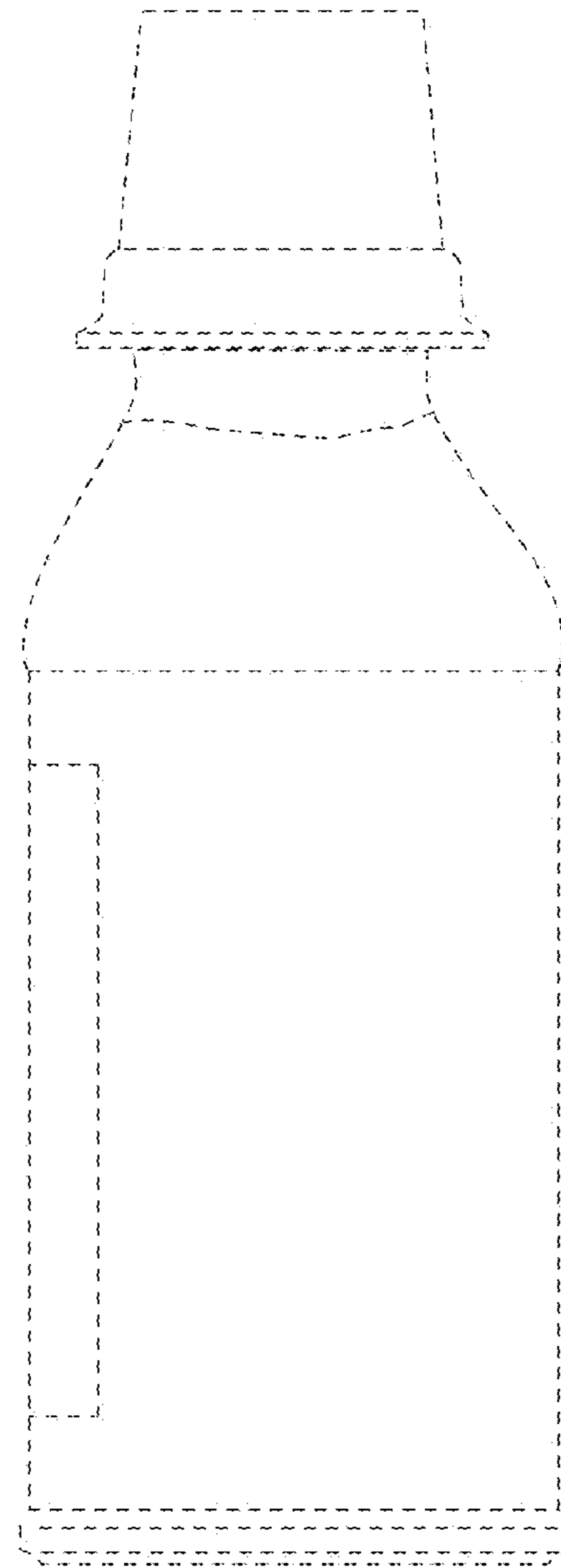

Fig. 18

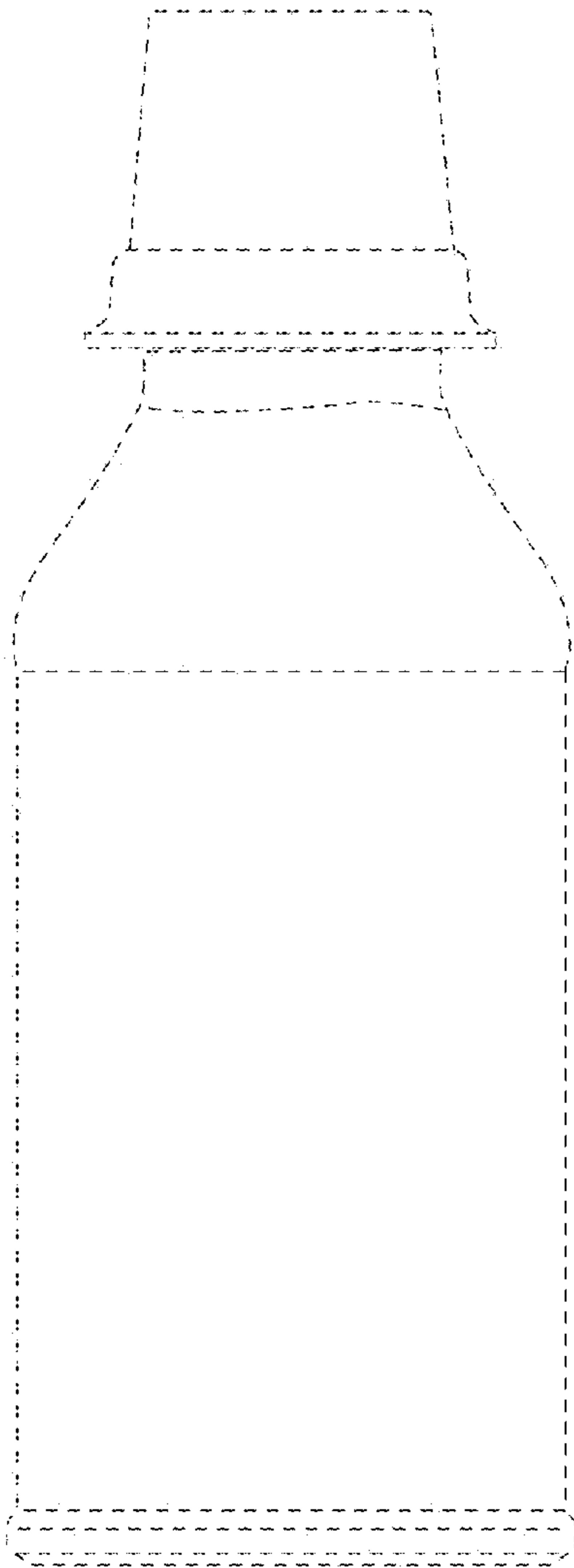

Fig. 19

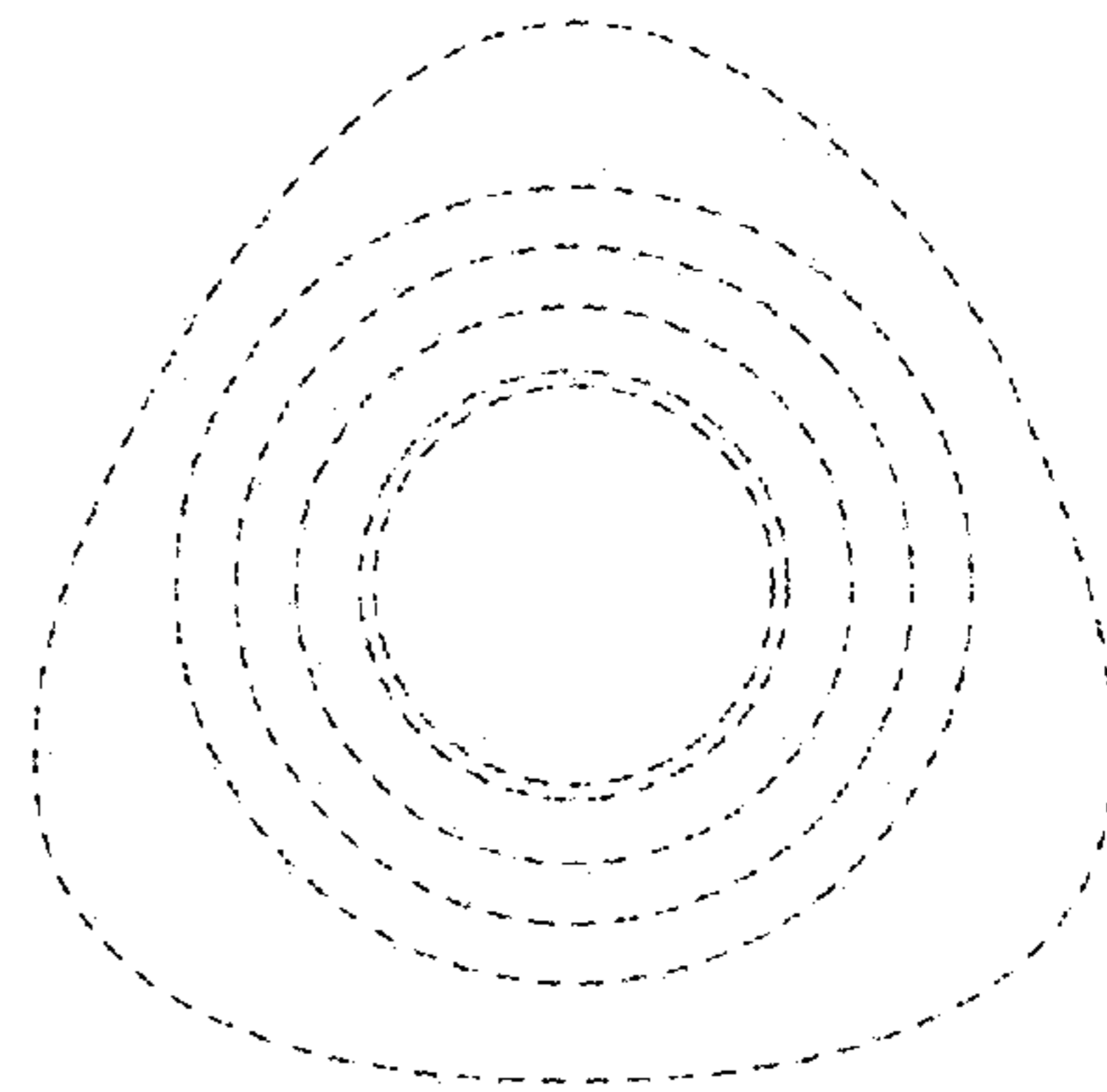

Fig. 20

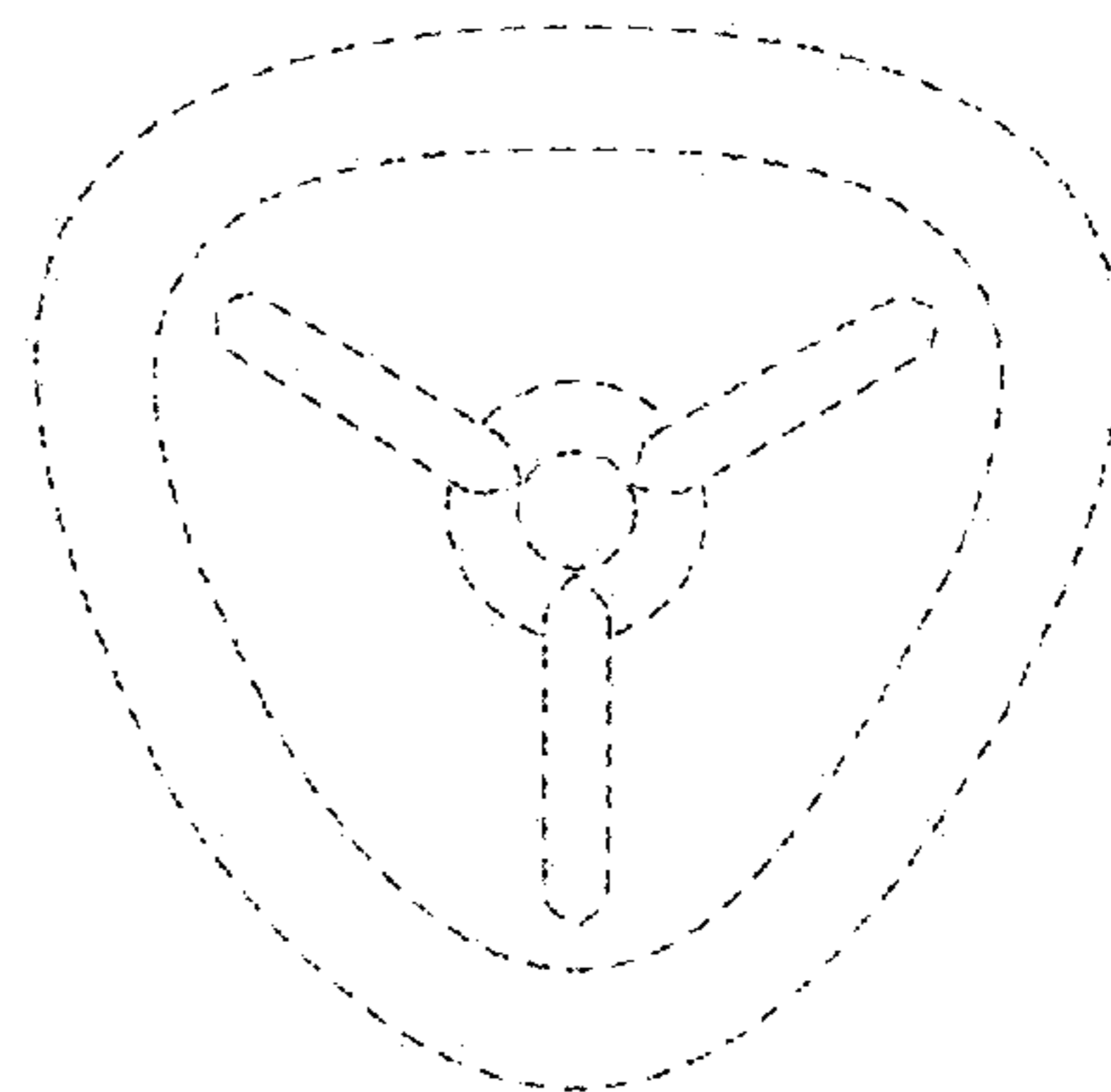

Fig. 21