



US00D744059S

(12) **United States Design Patent**  
**Fan et al.**

(10) **Patent No.:** **US D744,059 S**  
(45) **Date of Patent:** **\*\* Nov. 24, 2015**

- (54) **PORTABLE BATTERY STUN GUN DEVICE WITH FLASHLIGHT**
- (71) Applicants: **Zhigang Fan**, Jingjiang (CN); **Zhineng Fan**, Sugar Land, TX (US)
- (72) Inventors: **Zhigang Fan**, Jingjiang (CN); **Zhineng Fan**, Sugar Land, TX (US)
- (\*\*) Term: **14 Years**
- (21) Appl. No.: **29/497,143**
- (22) Filed: **Jul. 21, 2014**
- (51) **LOC (10) Cl.** ..... **22-01**
- (52) **U.S. Cl.**  
USPC ..... **D22/117**
- (58) **Field of Classification Search**  
USPC ..... D22/117; 42/1.08, 1.09; D26/38, 40, D26/42, 46, 49, 51; 362/157–158, 184, 362/194–208, 253  
See application file for complete search history.

D682,980 S \* 5/2013 Sheikh ..... D22/117  
D702,312 S \* 4/2014 Ying ..... D22/117  
D731,612 S \* 6/2015 Ying ..... D22/117

\* cited by examiner

*Primary Examiner* — Catheri Oliver-Garcia  
(74) *Attorney, Agent, or Firm* — Lai, Corsini & Lapus, LLC; Theodore Lapus

(57) **CLAIM**  
The ornamental design for a portable battery stun gun device with flashlight, as shown and described.

**DESCRIPTION**

FIG. 1 is a front view of a portable battery stun gun device with flashlight;  
FIG. 2 is a side view thereof;  
FIG. 3 is a rear view thereof, with the micro USB charging receptacle shown;  
FIG. 4 is an opposite side view thereof, with the switch and stun activate button shown;  
FIG. 5 is a top plan view thereof, with the flashlight header and stun prongs shown;  
FIG. 6 is a bottom plan view thereof, with the charging adaptor and power level LED indicator shown; and,  
FIG. 7 is a perspective view thereof.

**1 Claim, 7 Drawing Sheets**

- (56) **References Cited**  
U.S. PATENT DOCUMENTS  
D611,116 S \* 3/2010 Pennington ..... D22/117  
D661,771 S \* 6/2012 Nawaz ..... D22/117

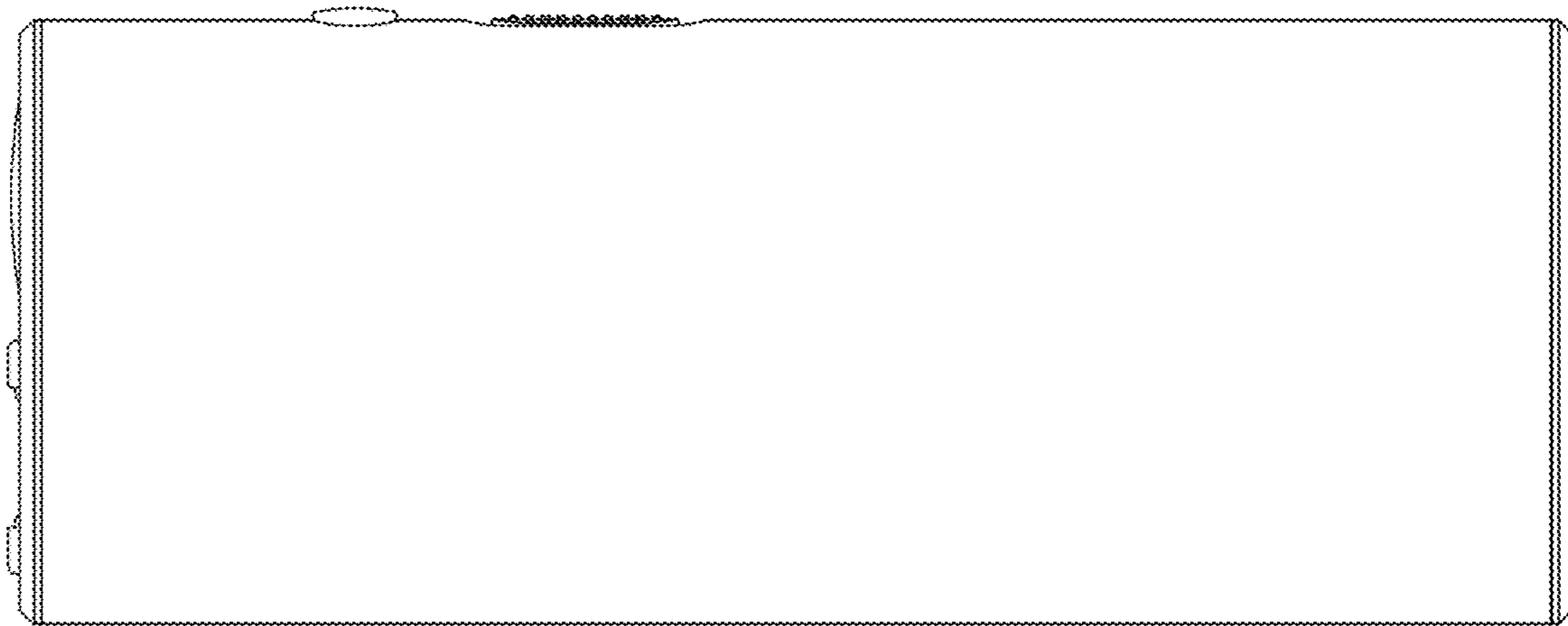

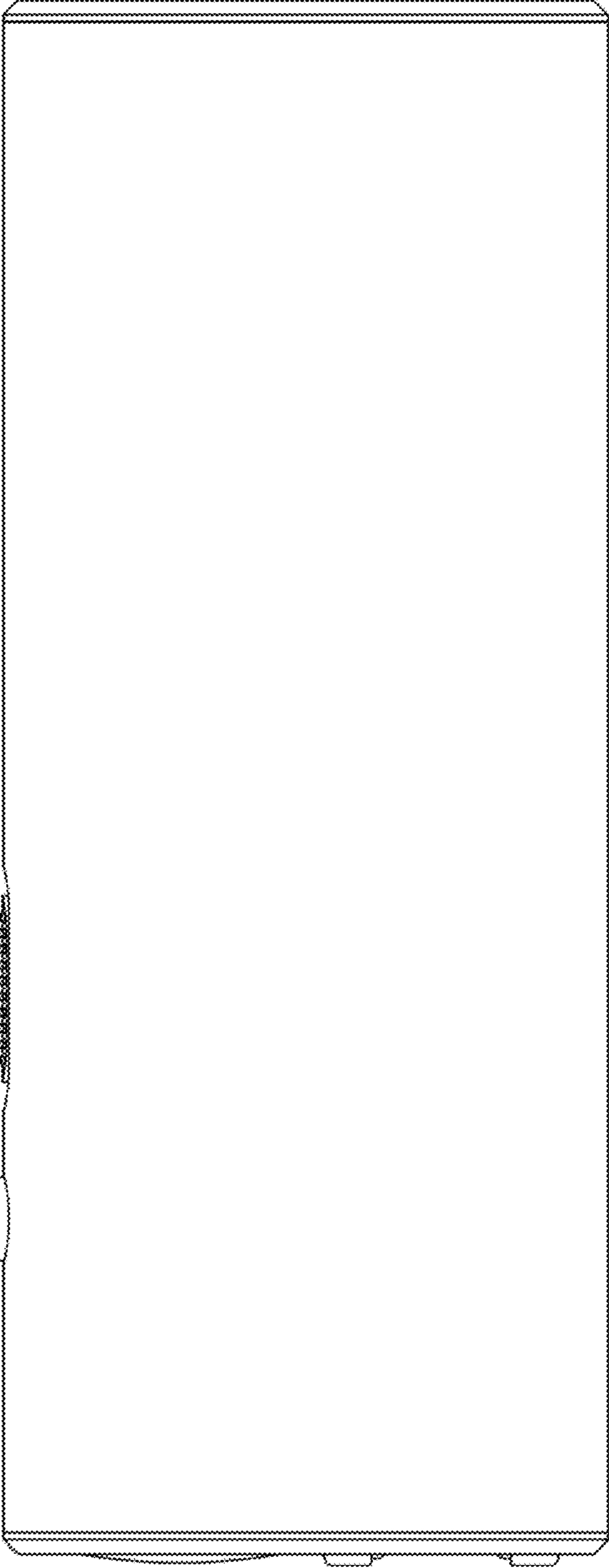

Figure 1

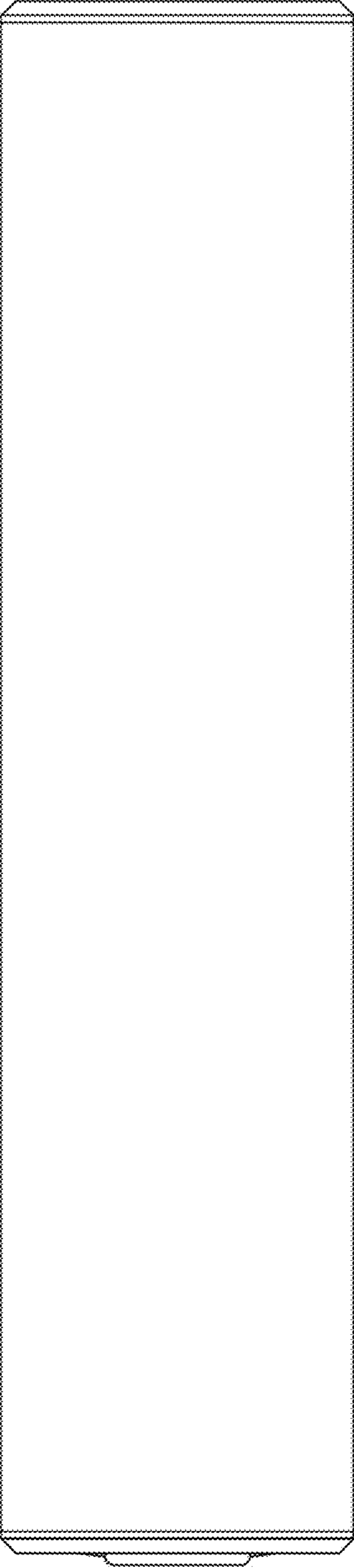

Figure 2

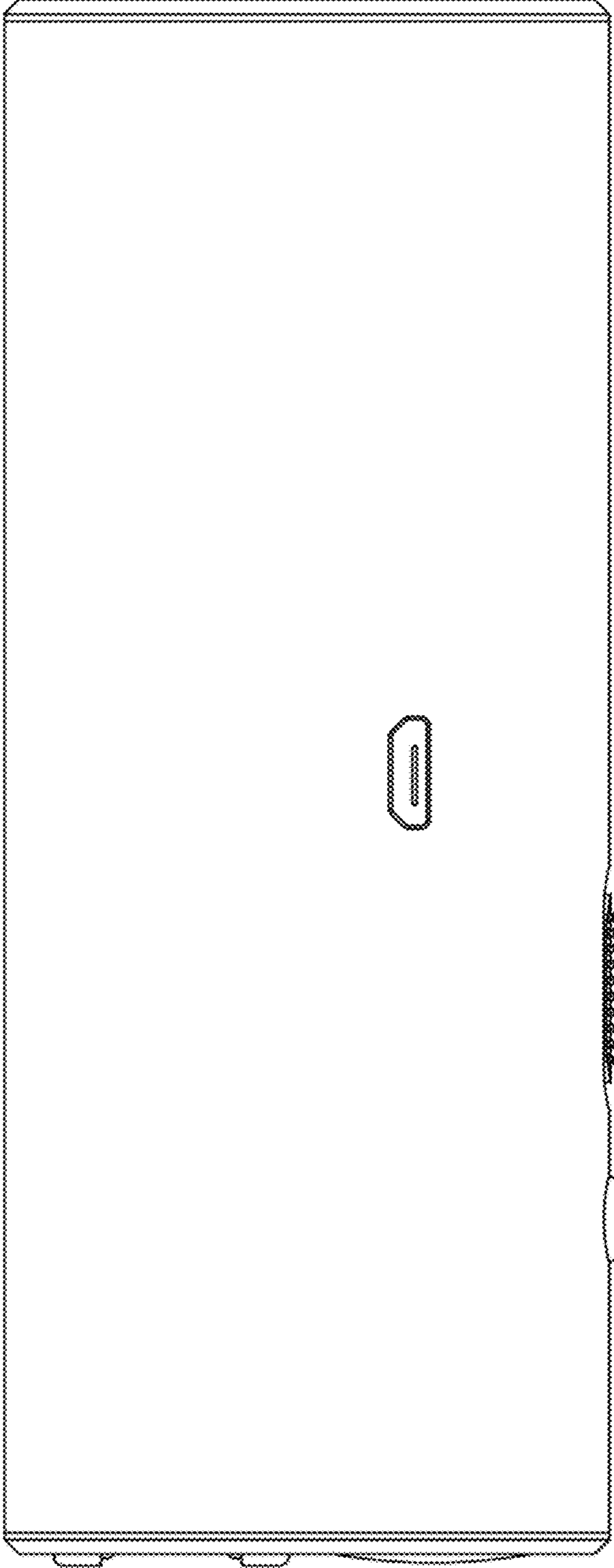

Figure 3

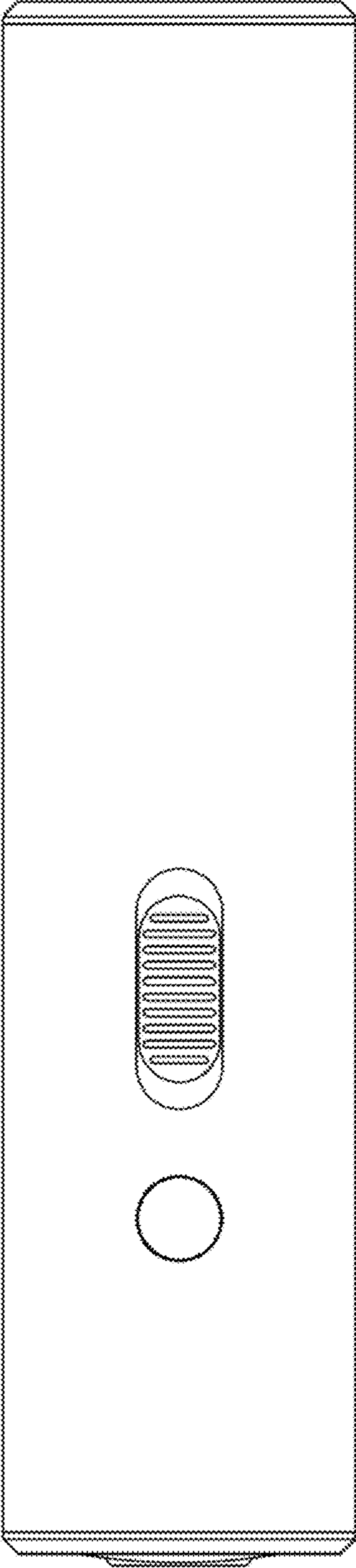

Figure 4

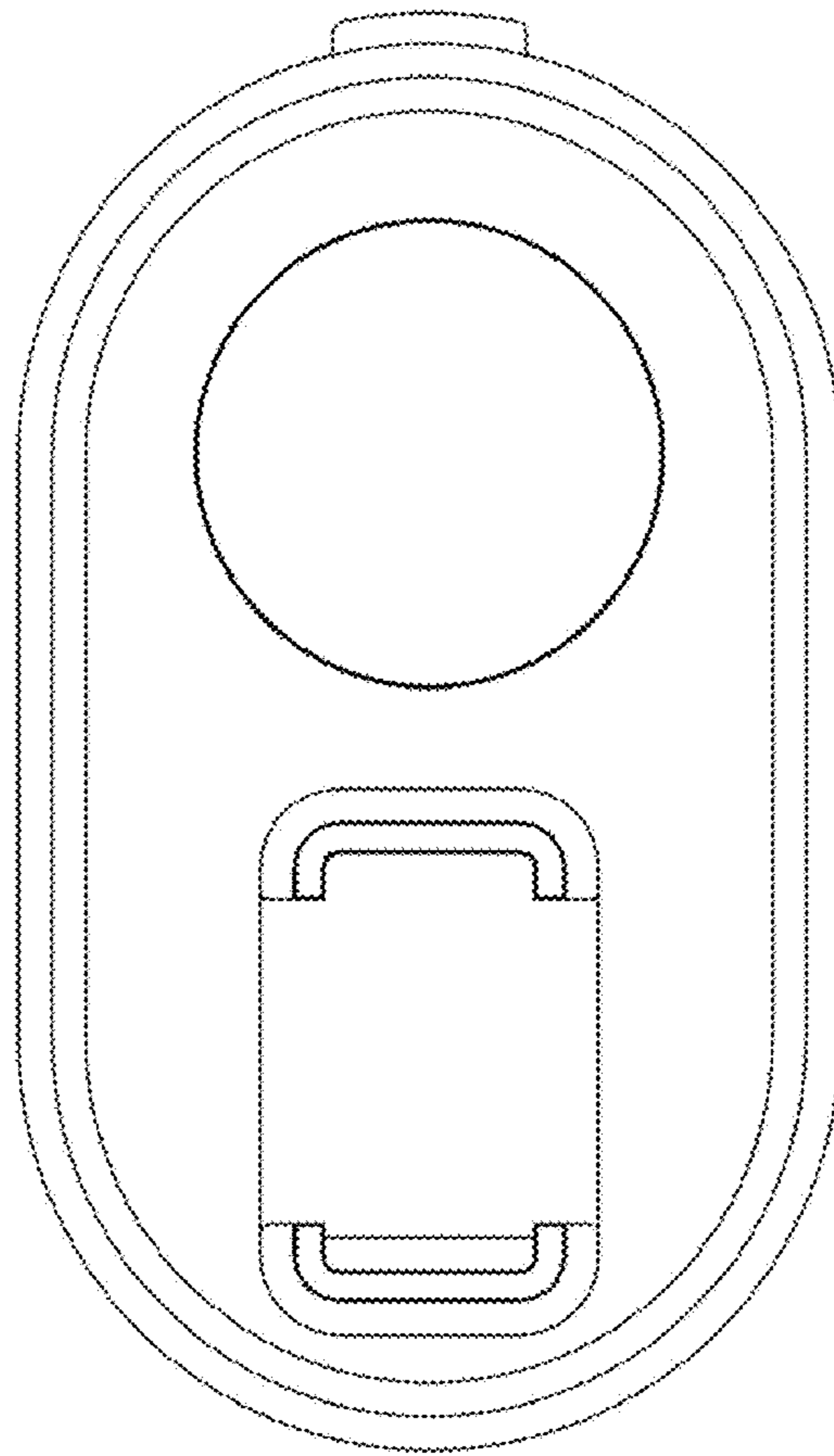

Figure 5

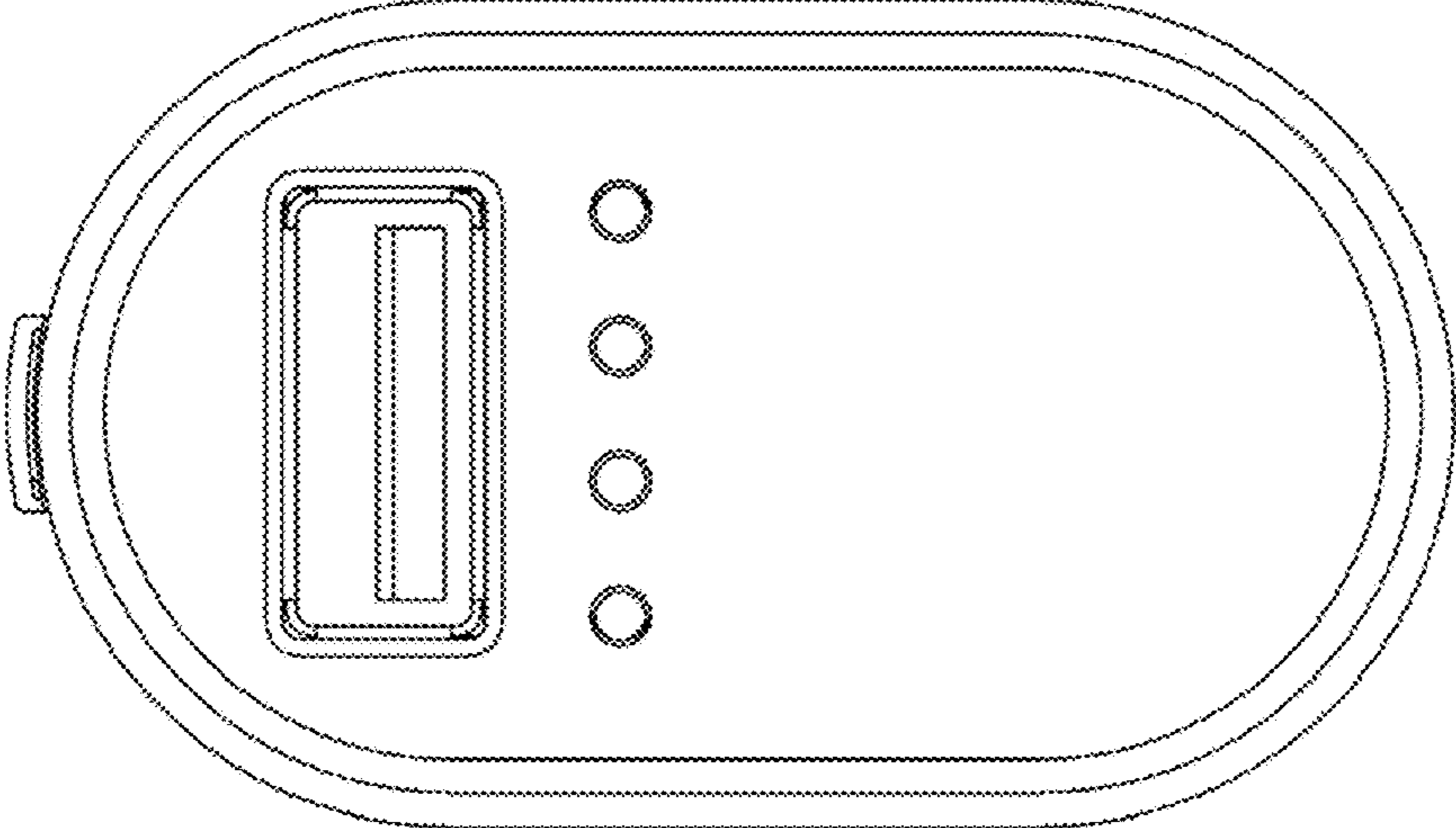

Figure 6

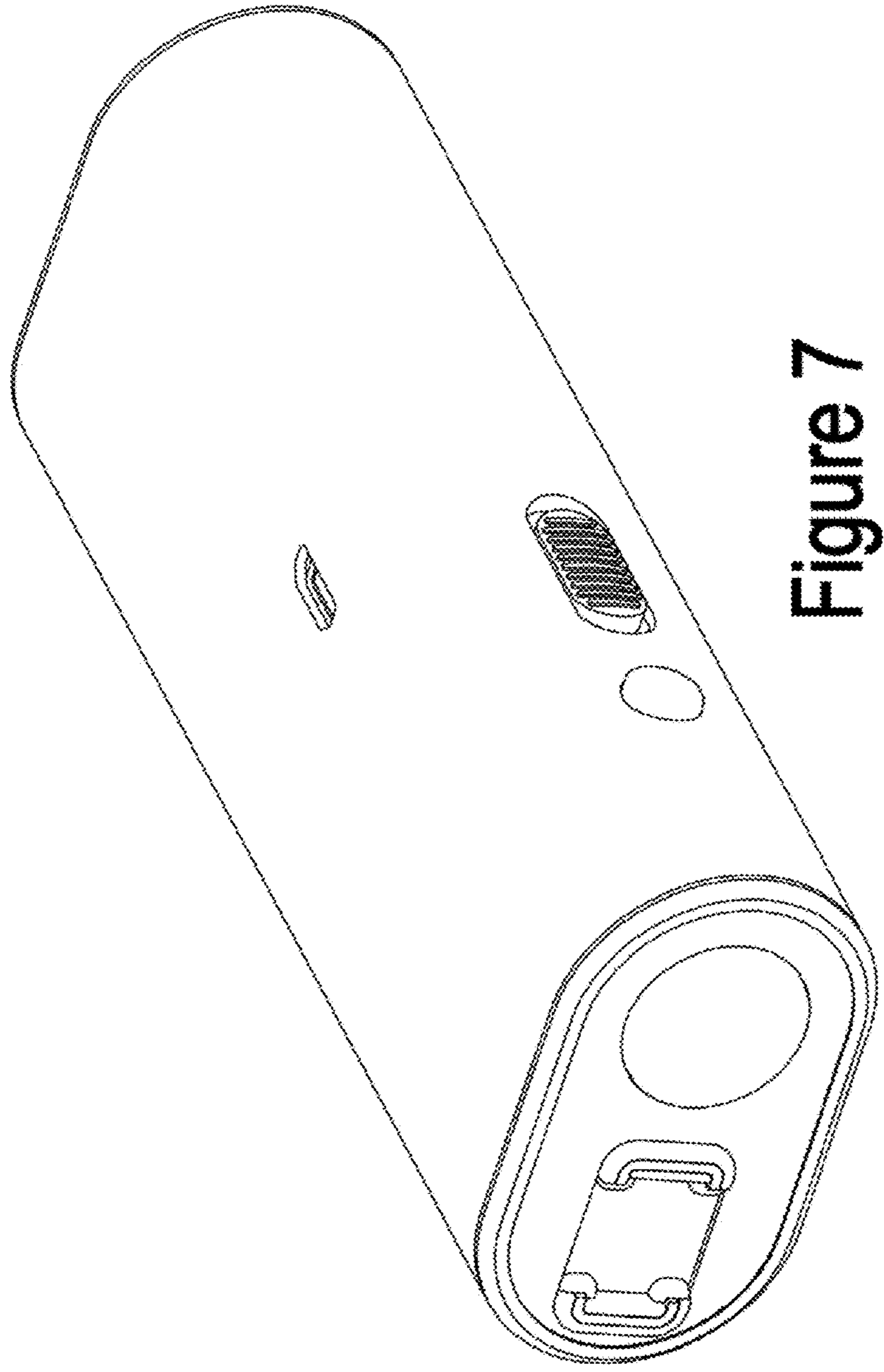

Figure 7