



US00D744056S

(12) **United States Design Patent**  
**Jammet**

(10) **Patent No.:** **US D744,056 S**

(45) **Date of Patent:** **\*\* Nov. 24, 2015**

(54) **PISTOL GRIP ASSEMBLY**

(71) Applicant: **Julien Jammet**, La Celle Saint Cloud (FR)

(72) Inventor: **Julien Jammet**, La Celle Saint Cloud (FR)

(\*\*) Term: **14 Years**

(21) Appl. No.: **29/497,485**

(22) Filed: **Jul. 24, 2014**

(51) **LOC (10) Cl.** ..... **22-01**

(52) **U.S. Cl.**  
USPC ..... **D22/108**

(58) **Field of Classification Search**  
USPC ..... D22/103, 108  
CPC ..... F41C 23/10; F41C 23/14; F41C 23/16;  
F41C 23/18  
See application file for complete search history.

(56) **References Cited**

**U.S. PATENT DOCUMENTS**

- 1,404,040 A \* 1/1922 Mader ..... F41A 3/20  
24/129 D
- 4,024,664 A \* 5/1977 Murabito ..... F41A 17/80  
42/70.08
- D679,772 S \* 4/2013 Mossberg, Jr. .... D22/103
- 2002/0116856 A1 \* 8/2002 Troyer ..... F41A 17/54

- 2007/0006508 A1 \* 1/2007 Baker ..... F41C 23/12  
42/70.11
- 2007/0214696 A1 \* 9/2007 Barnett ..... F41C 7/06  
42/71.02  
42/16

\* cited by examiner

*Primary Examiner* — Michael A Pratt

(74) *Attorney, Agent, or Firm* — Robert T. Maldonado; Cooper & Dunham LLP

(57) **CLAIM**

The ornamental design for a pistol grip assembly, as shown and described.

**DESCRIPTION**

FIG. 1 is a top perspective view of a pistol grip assembly in accordance with the present design;  
FIG. 2 is a bottom perspective view thereof;  
FIG. 3 is a front view thereof;  
FIG. 4 is a back view thereof;  
FIG. 5 is a right side view thereof;  
FIG. 6 is a left side view thereof;  
FIG. 7 is a top view thereof; and,  
FIG. 8 is a bottom view thereof.

The broken lines are for illustrative purposes only and form no part of the claimed design. The shading represents contour of the claimed design.

**1 Claim, 4 Drawing Sheets**

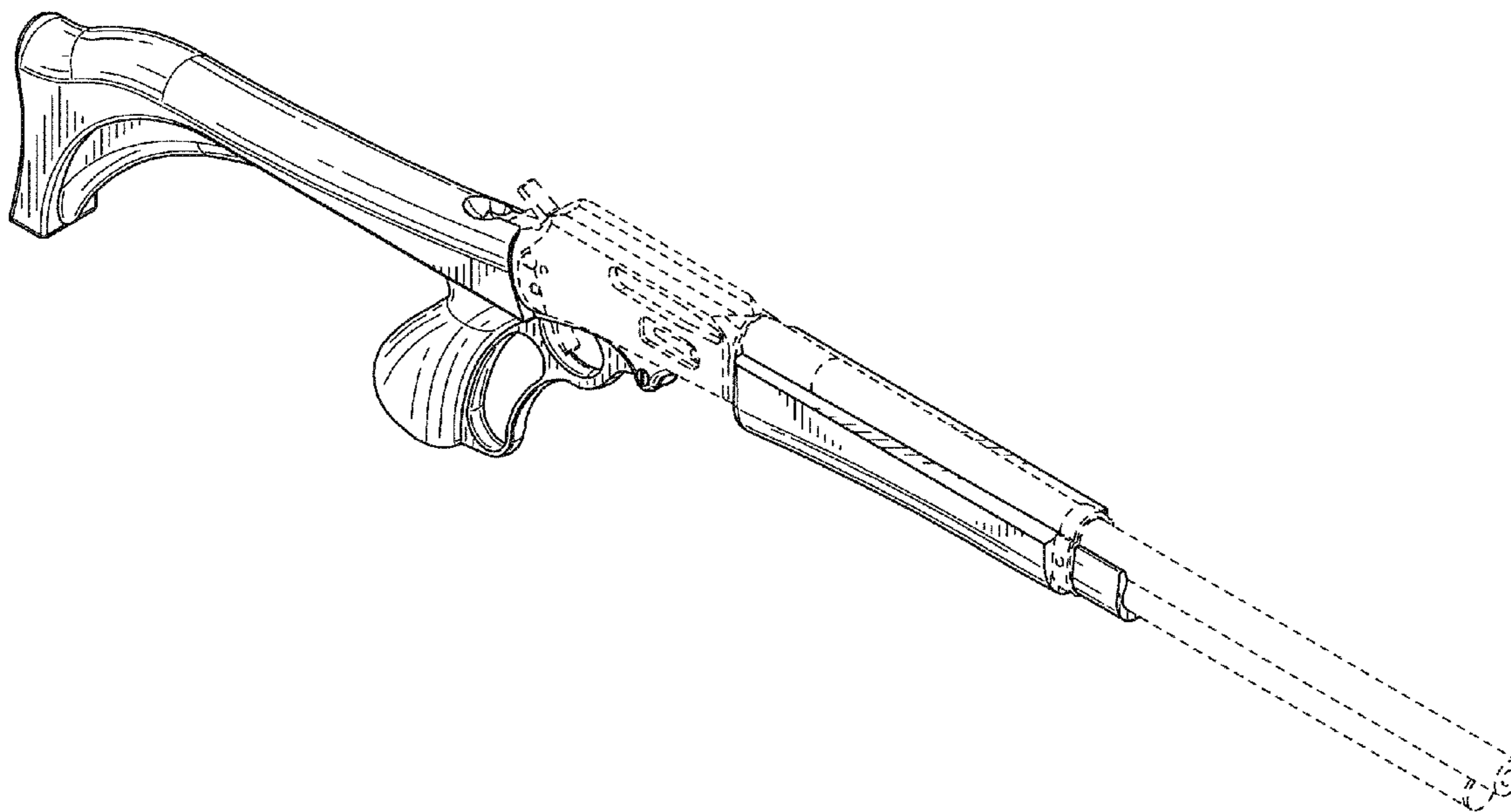

FIG. 1

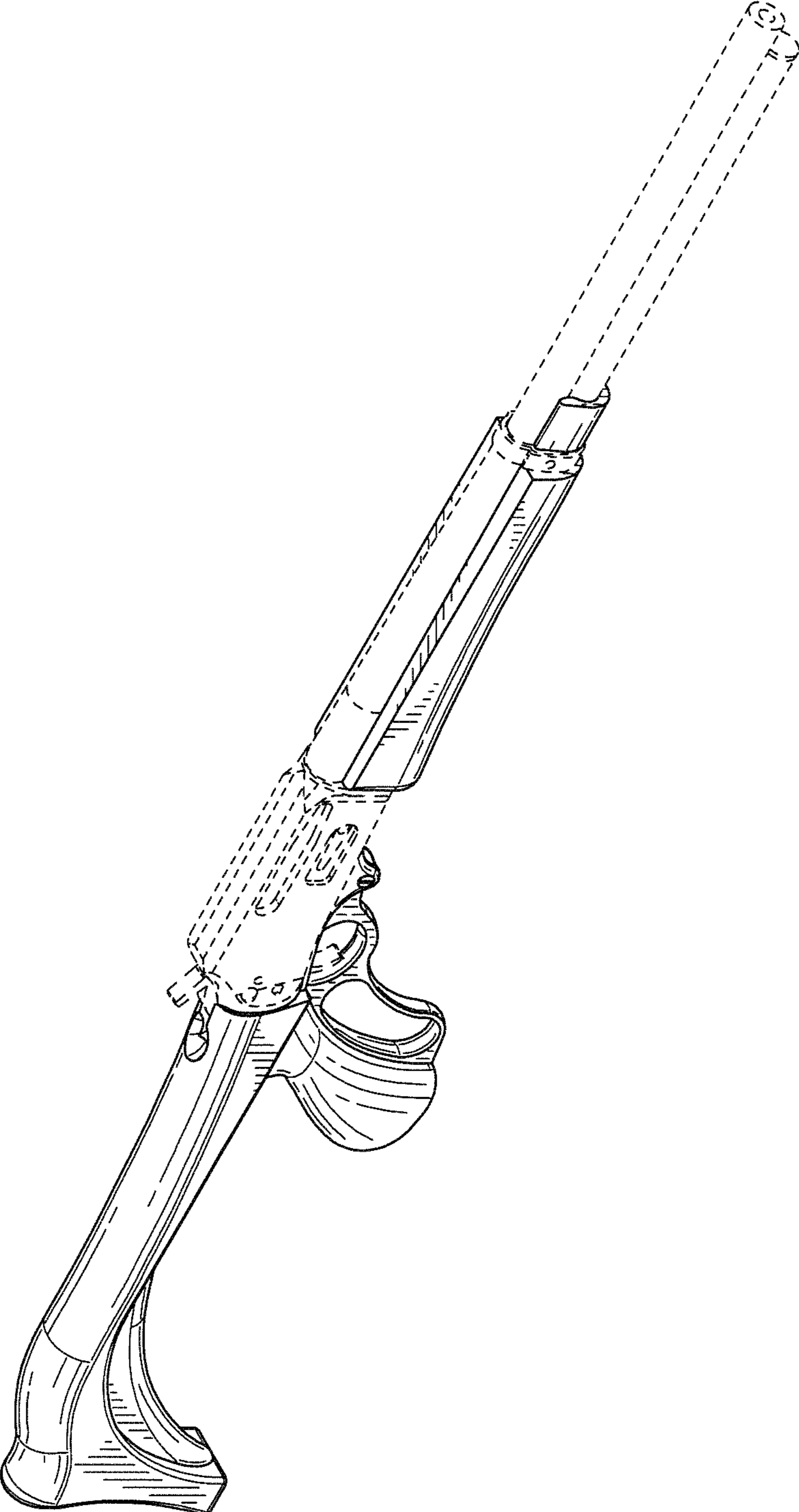

FIG. 2

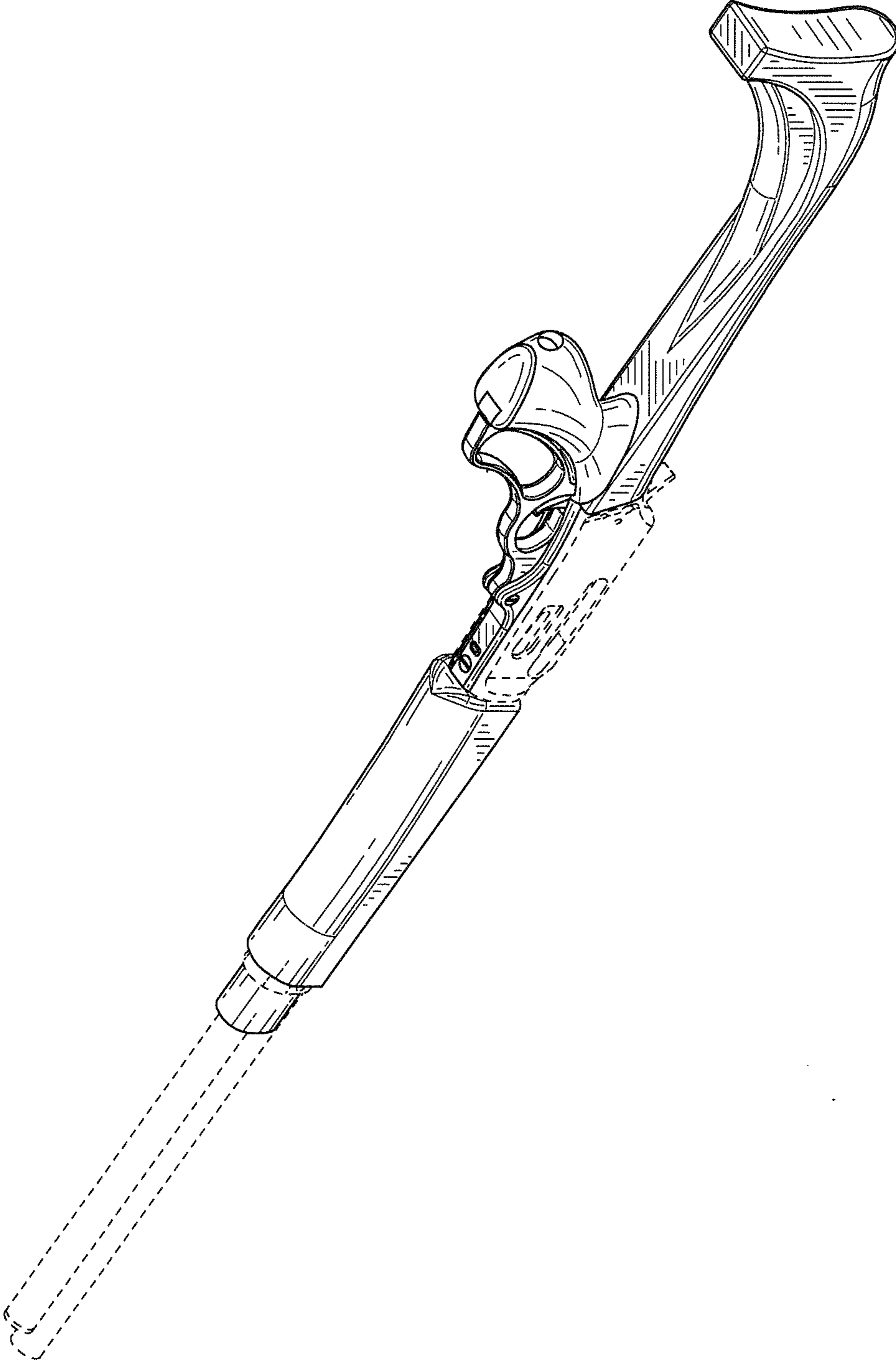

FIG. 3

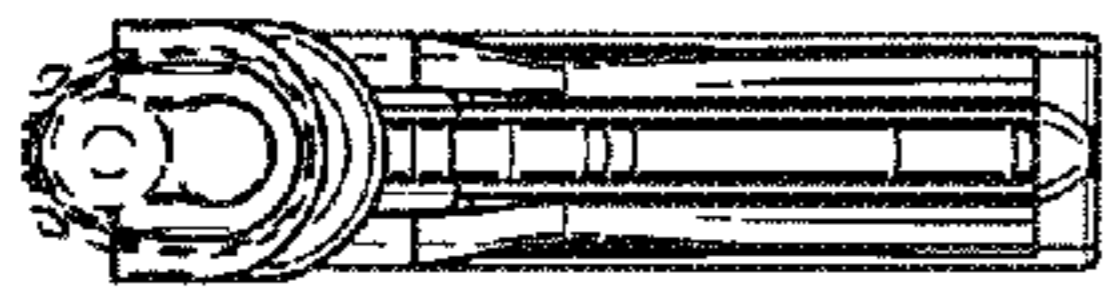

FIG. 4

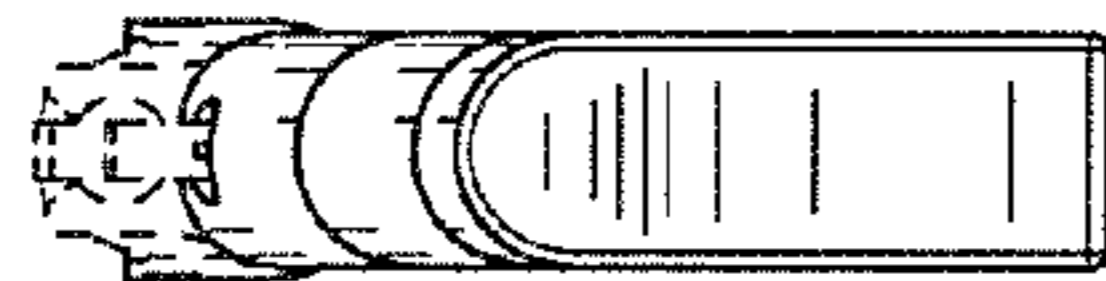

FIG. 5

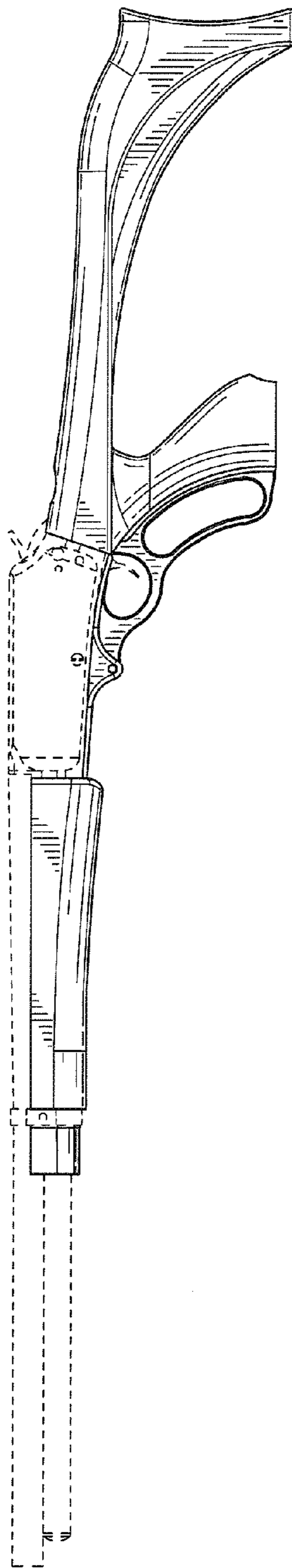

FIG. 6

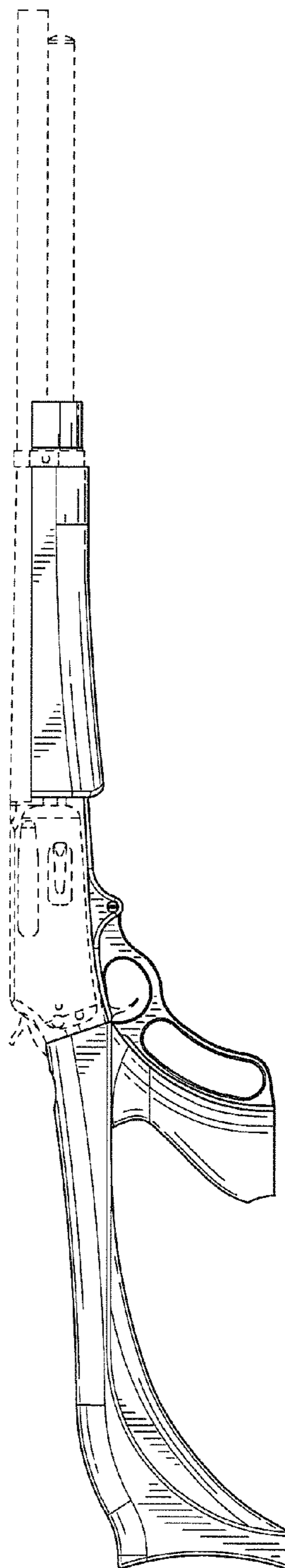

FIG. 7



FIG. 8

