



US00D744038S

(12) **United States Design Patent**
Wang

(10) **Patent No.:** **US D744,038 S**

(45) **Date of Patent:** **** Nov. 24, 2015**

(54) **CHALK**

(71) Applicant: **Xiaoyan Wang**, Shangrao (CN)

(72) Inventor: **Xiaoyan Wang**, Shangrao (CN)

(**) Term: **14 Years**

(21) Appl. No.: **29/501,255**

(22) Filed: **Sep. 3, 2014**

(30) **Foreign Application Priority Data**

Aug. 7, 2014 (CN) 2014 3 0277186

(51) **LOC (10) CL.** **19-06**

(52) **U.S. Cl.**

USPC **D19/182**; D19/912; D19/917

(58) **Field of Classification Search**

USPC D8/98, 99; D14/411; D19/115–204;
D28/7; D10/119.3, 119.4

CPC B43K 5/005; B43K 7/00; B43K 7/01;
B43K 7/10; B43K 7/12; B43K 19/00; B43K
19/02; B43K 8/04; B43K 19/14; B43K
23/016; B43K 19/003

See application file for complete search history.

(56) **References Cited**

U.S. PATENT DOCUMENTS

D60,192 S * 1/1922 Mason, Jr. D19/46
D323,683 S * 2/1992 Isaacs D21/440

D383,162 S * 9/1997 Worther D19/173
D500,799 S * 1/2005 Olson D10/78
D552,175 S * 10/2007 Boerio D19/175
D587,310 S * 2/2009 Paslawski D19/185
D619,580 S * 7/2010 Nakayama et al. D14/411
D641,755 S * 7/2011 Rashid et al. D14/411
D675,621 S * 2/2013 Fletcher et al. D14/411
D688,665 S * 8/2013 Huang D14/411
D695,741 S * 12/2013 Wang D14/411
D706,267 S * 6/2014 Nakata D14/411
D709,886 S * 7/2014 Lin D14/411

* cited by examiner

Primary Examiner — Elizabeth Albert

(74) *Attorney, Agent, or Firm* — Matthias Scholl, PC;
Matthias Scholl

(57) **CLAIM**

The ornamental design for chalk, as shown and described.

DESCRIPTION

FIG. 1 is a front elevational view of chalk;
FIG. 2 is a rear elevational view thereof;
FIG. 3 is a left side elevational view thereof;
FIG. 4 is a right side elevational view thereof;
FIG. 5 is a top plan view thereof;
FIG. 6 is a bottom plan view thereof; and,
FIG. 7 is a perspective view thereof.

1 Claim, 7 Drawing Sheets

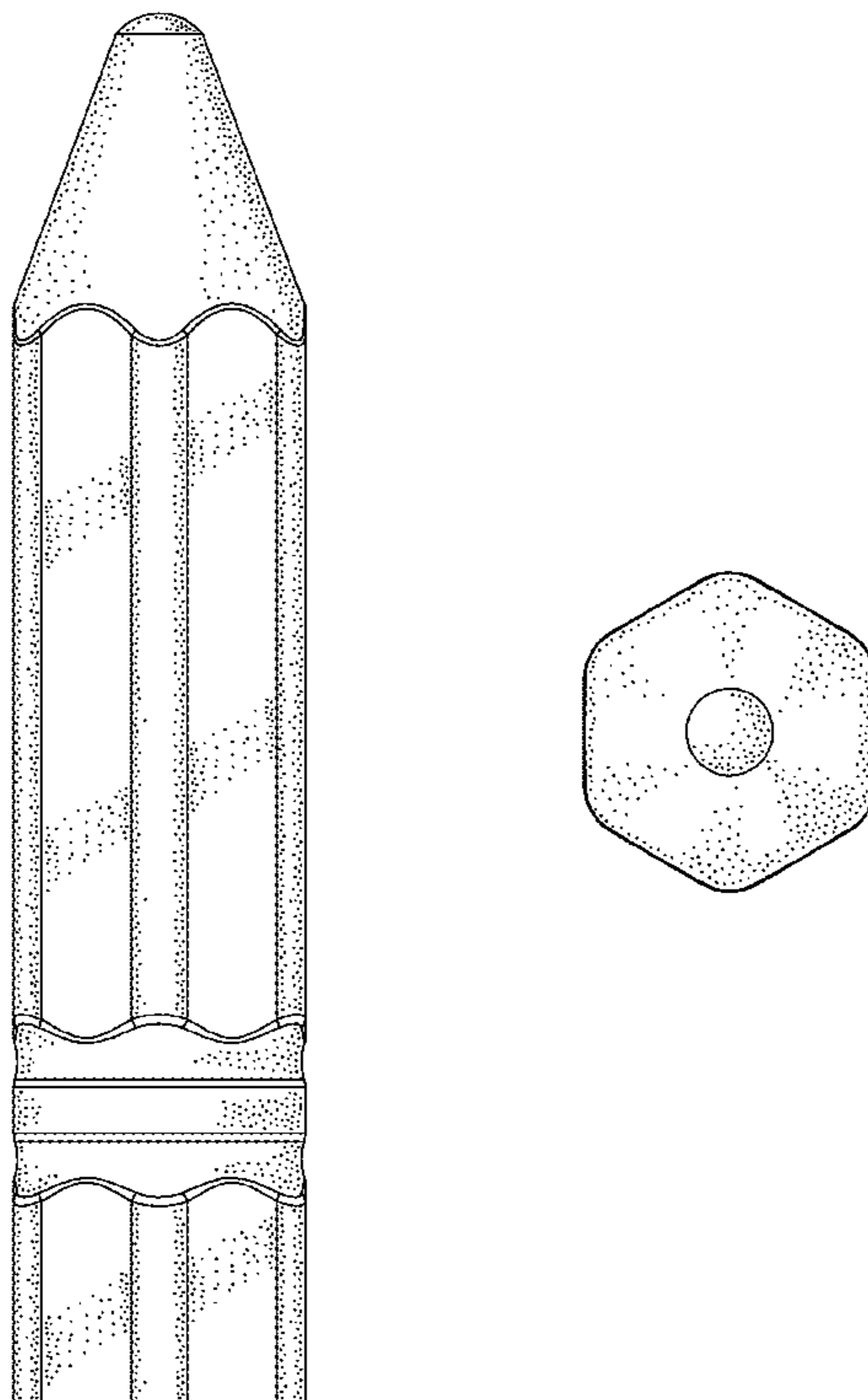

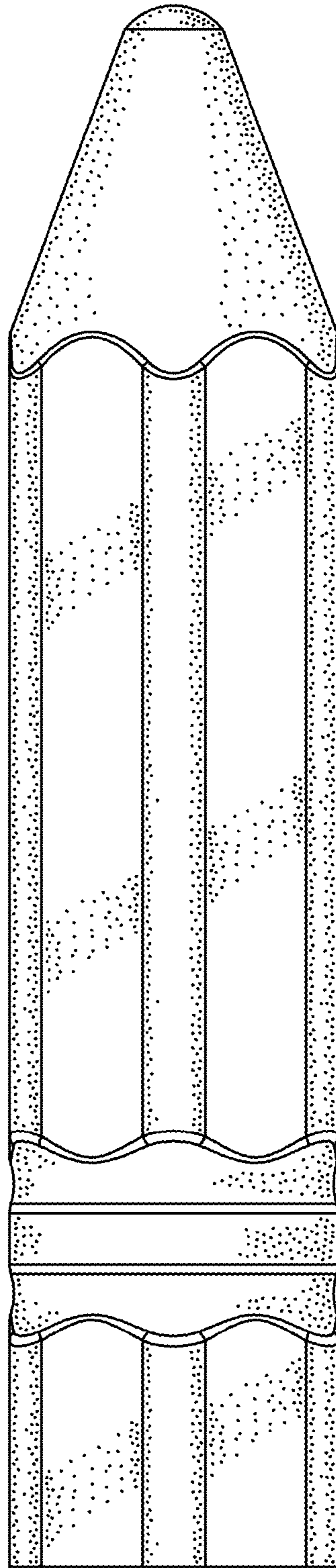

FIG. 1

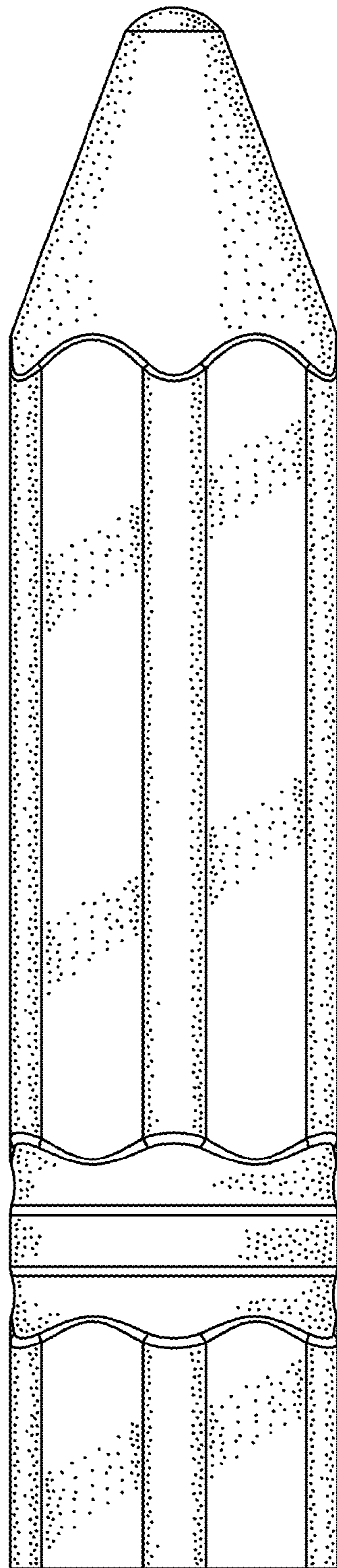

FIG. 2

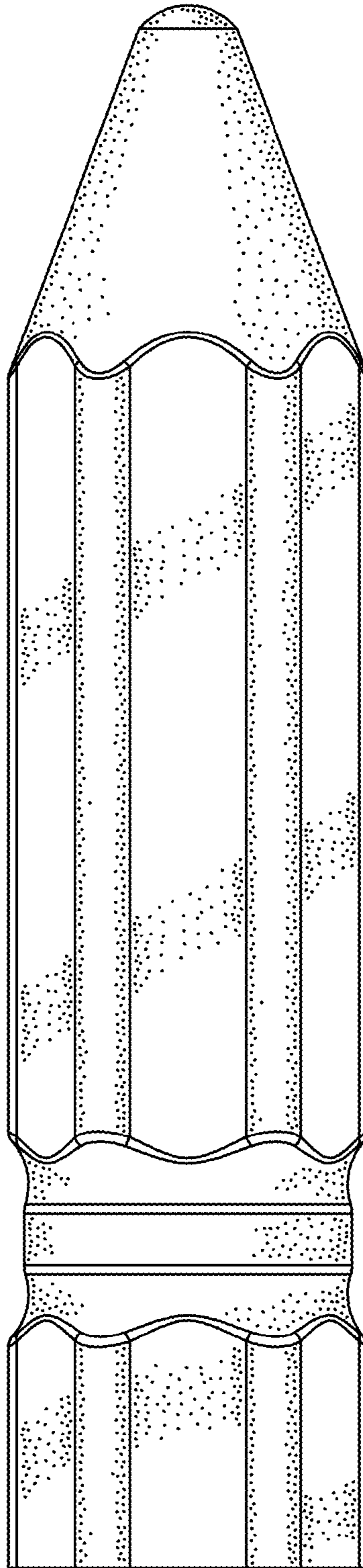

FIG. 3

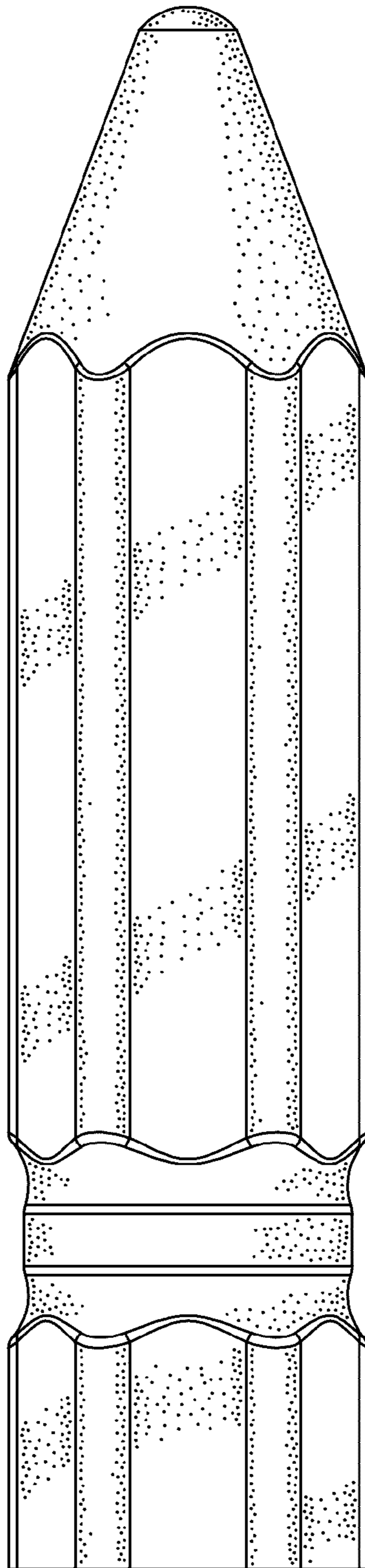

FIG. 4

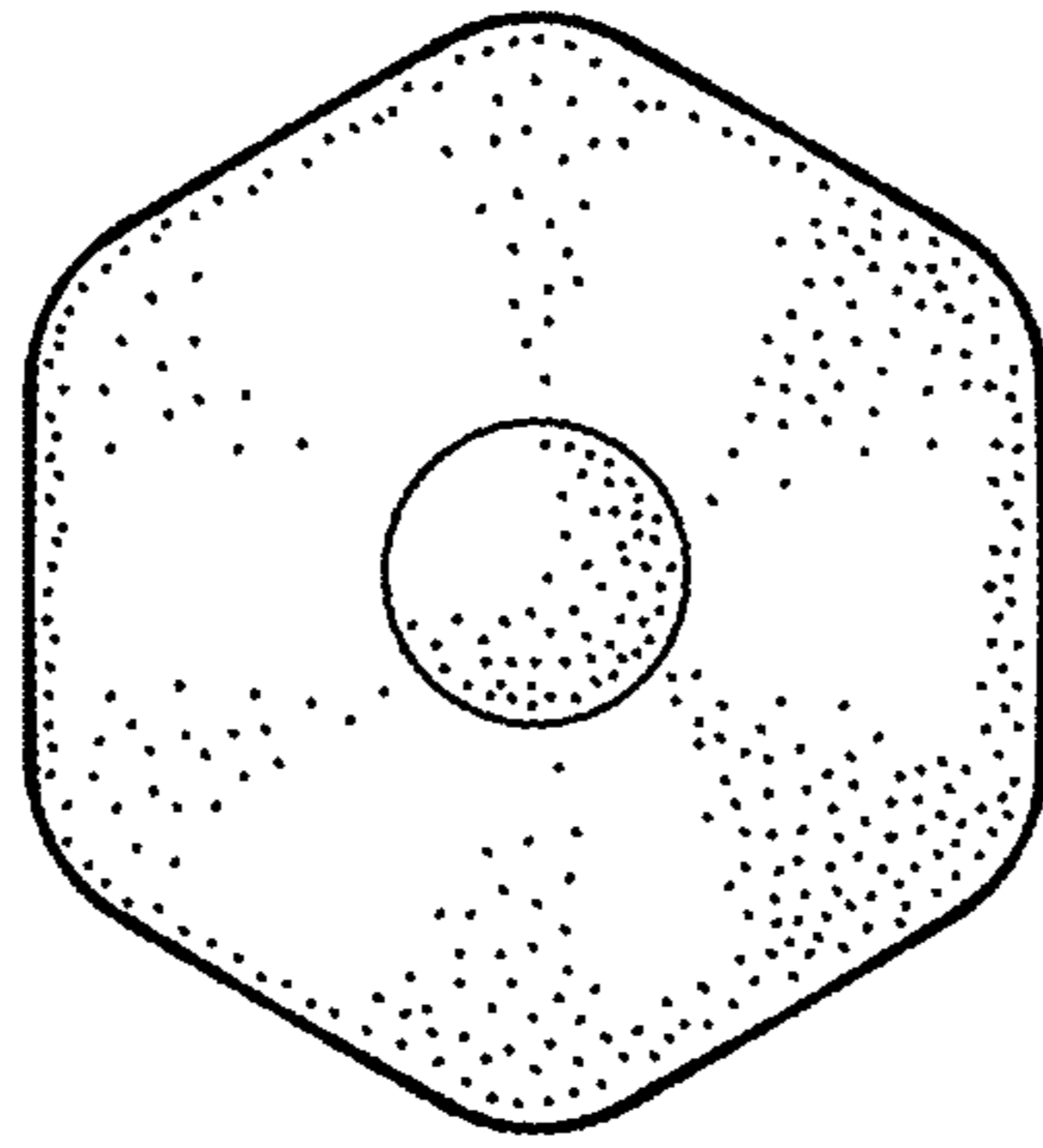

FIG. 5

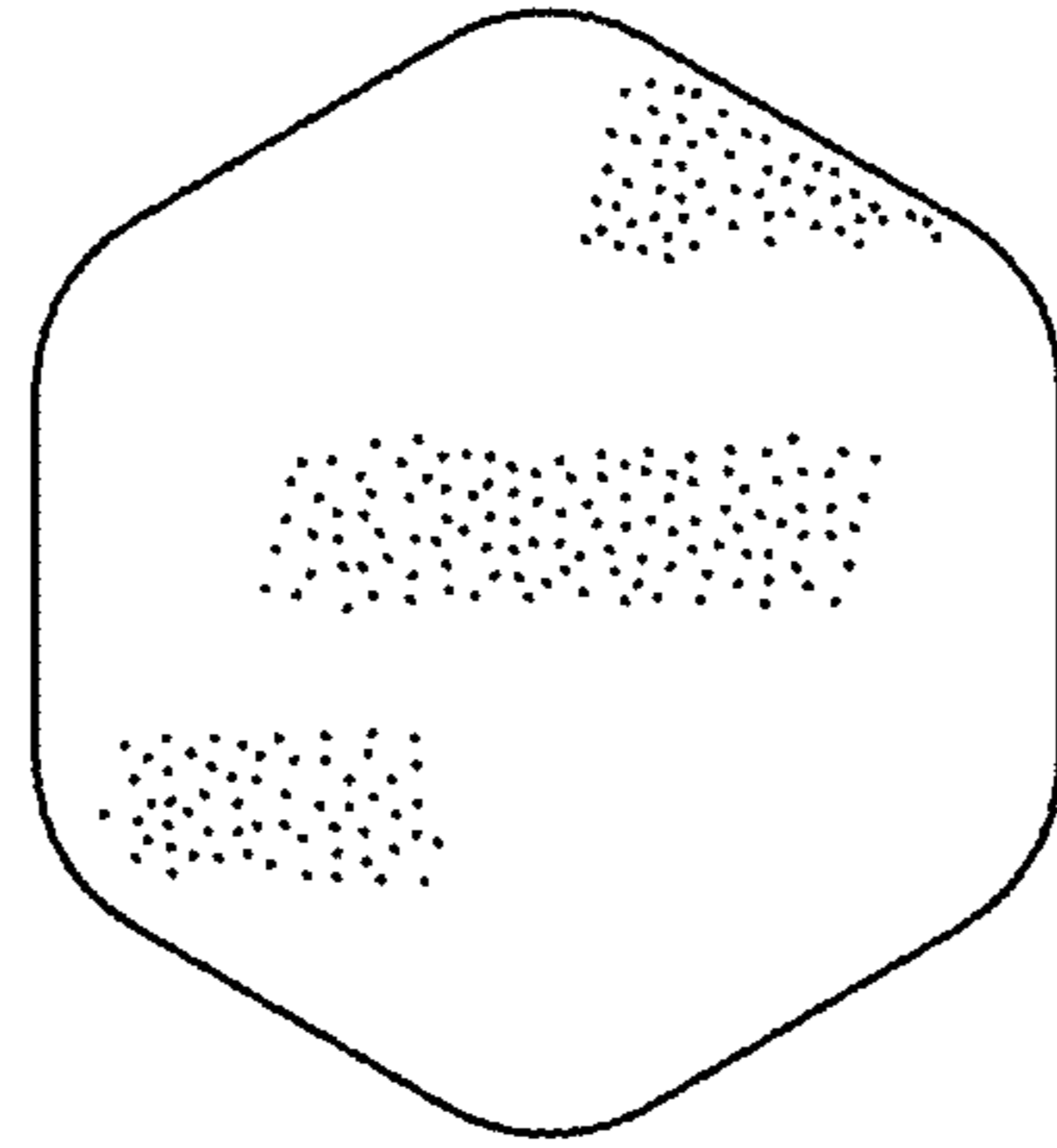

FIG. 6

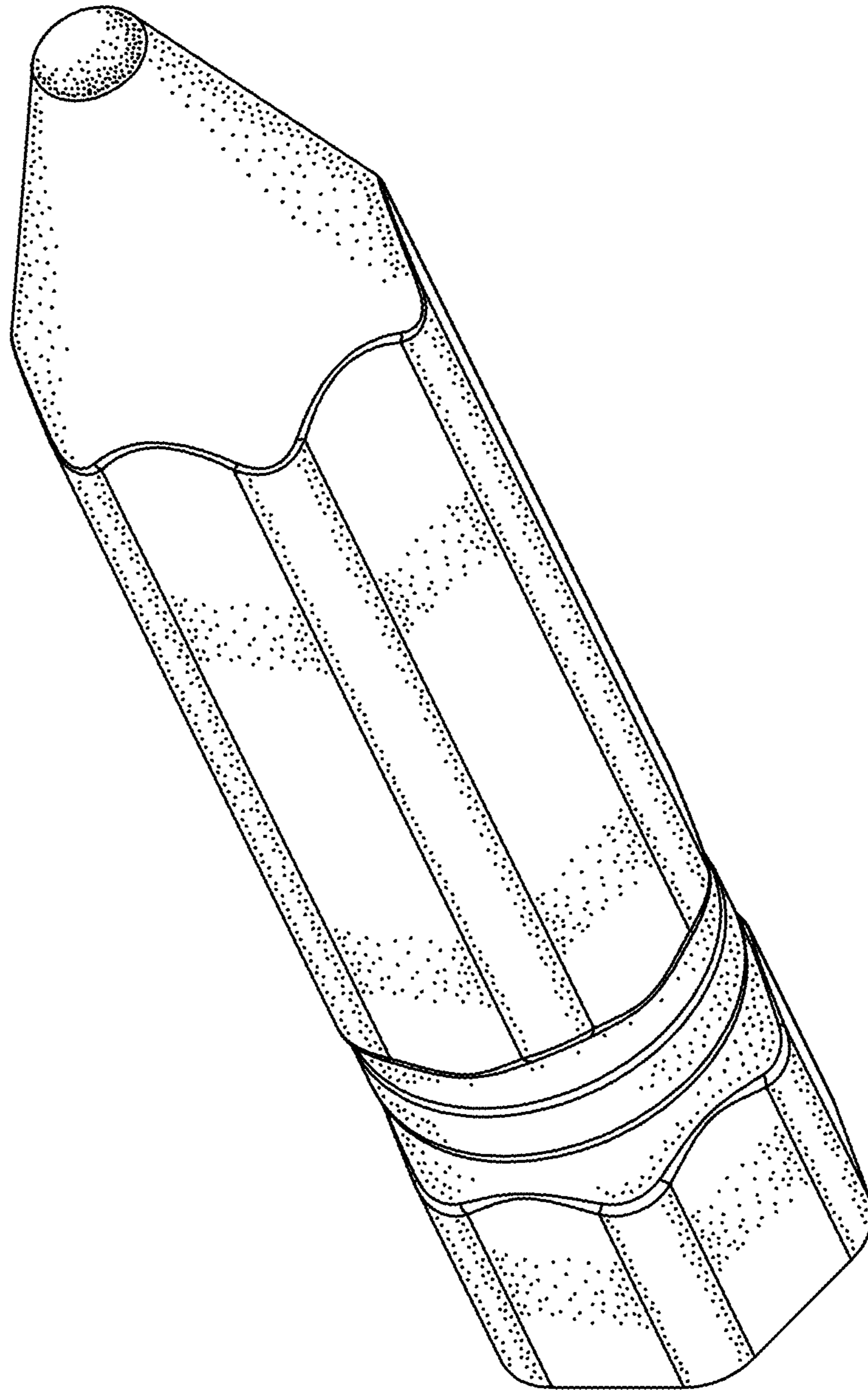

FIG. 7