



US00D743961S

(12) **United States Design Patent**  
**Oh et al.**

(10) **Patent No.:** **US D743,961 S**  
(45) **Date of Patent:** **\*\* Nov. 24, 2015**

(54) **ELECTRONIC DEVICE**

(71) Applicant: **Samsung Electronics Co., Ltd.**,  
Suwon-si (KR)  
(72) Inventors: **Christine Rhea Oh**, Yongin (KR);  
**Tae-Joong Kim**, Seoul (KR)  
(73) Assignee: **Samsung Electronics Co., Ltd.**,  
Suwon-si (KR)

(\*\*) Term: **14 Years**

(21) Appl. No.: **29/480,222**

(22) Filed: **Jan. 24, 2014**

(30) **Foreign Application Priority Data**

Aug. 27, 2013 (KR) ..... 30-2013-0043844

(51) **LOC (10) Cl.** ..... **14-02**

(52) **U.S. Cl.**  
USPC ..... **D14/341**

(58) **Field of Classification Search**  
USPC ..... D14/315-318, 341-344, 129, 130, 496,  
D14/137, 138 R, 138 AA, 138 C, 138 G, 147,  
D14/203.1, 203.3, 203.4, 203.7, 247, 389;  
D6/300-302, 308, 310; D18/6, 7;  
D21/324, 329, 330, 332; 455/556.2,  
455/566; 379/916, 433.04, 433.1; 345/901,  
345/905, 173; 361/679.26, 679.3, 679.55,  
361/679.56  
CPC ..... H04M 1/0202; H04M 1/0279; H04M  
1/0281; H04M 1/0283; G06F 1/1613; G06F  
15/00; A63H 33/3016; G01S 17/74; G01S  
17/08

See application file for complete search history.

(56) **References Cited**

**U.S. PATENT DOCUMENTS**

D360,632 S \* 7/1995 Nagele et al. .... D14/138 AA  
D472,895 S \* 4/2003 Ribeiro et al. .... D14/248

(Continued)

**OTHER PUBLICATIONS**

Samsung Galaxy Note 10.1 (2014 ED) (GSMArena), available Oct. 2013, [online], [site visited Apr. 29, 2015]. Available from internet, <URL: http://www.gsmaarena.com/samsung\_galaxy\_note\_10\_1\_(2014\_edition)-5677.php.\*

(Continued)

*Primary Examiner* — Cathron Brooks

*Assistant Examiner* — Teddy Falloway

(74) *Attorney, Agent, or Firm* — NSIP Law

(57) **CLAIM**

The ornamental design for an electronic device, as shown and described.

**DESCRIPTION**

FIG. 1 is a front perspective view of an electronic device showing our new design;

FIG. 2 is a front view thereof;

FIG. 3 is a rear view thereof;

FIG. 4 is a left-side view thereof;

FIG. 5 is a right-side view thereof;

FIG. 6 is a top view thereof;

FIG. 7 is a bottom view thereof;

FIG. 8 is an enlarged view of the encircled portion as shown in FIG. 1;

FIG. 9 is an enlarged view of the encircled portion as shown in FIG. 3;

FIG. 10 is an enlarged view of the encircled portion as shown in FIG. 5; and,

FIG. 11 is an enlarged view of the encircled portion as shown in FIG. 6.

The dash-dash broken lines shown in the figures that exist on shaded surfaces represent environment, while the dash-dash broken lines shown in the figures that exist on unshaded surfaces represent environment that is understood to create boundaries between the claimed and non-claimed areas.

The dot-dash broken lines shown in FIGS. 1, 3, 5, 6, and 8-11 identify an enlarged view and form no part of the claimed design.

**1 Claim, 7 Drawing Sheets**

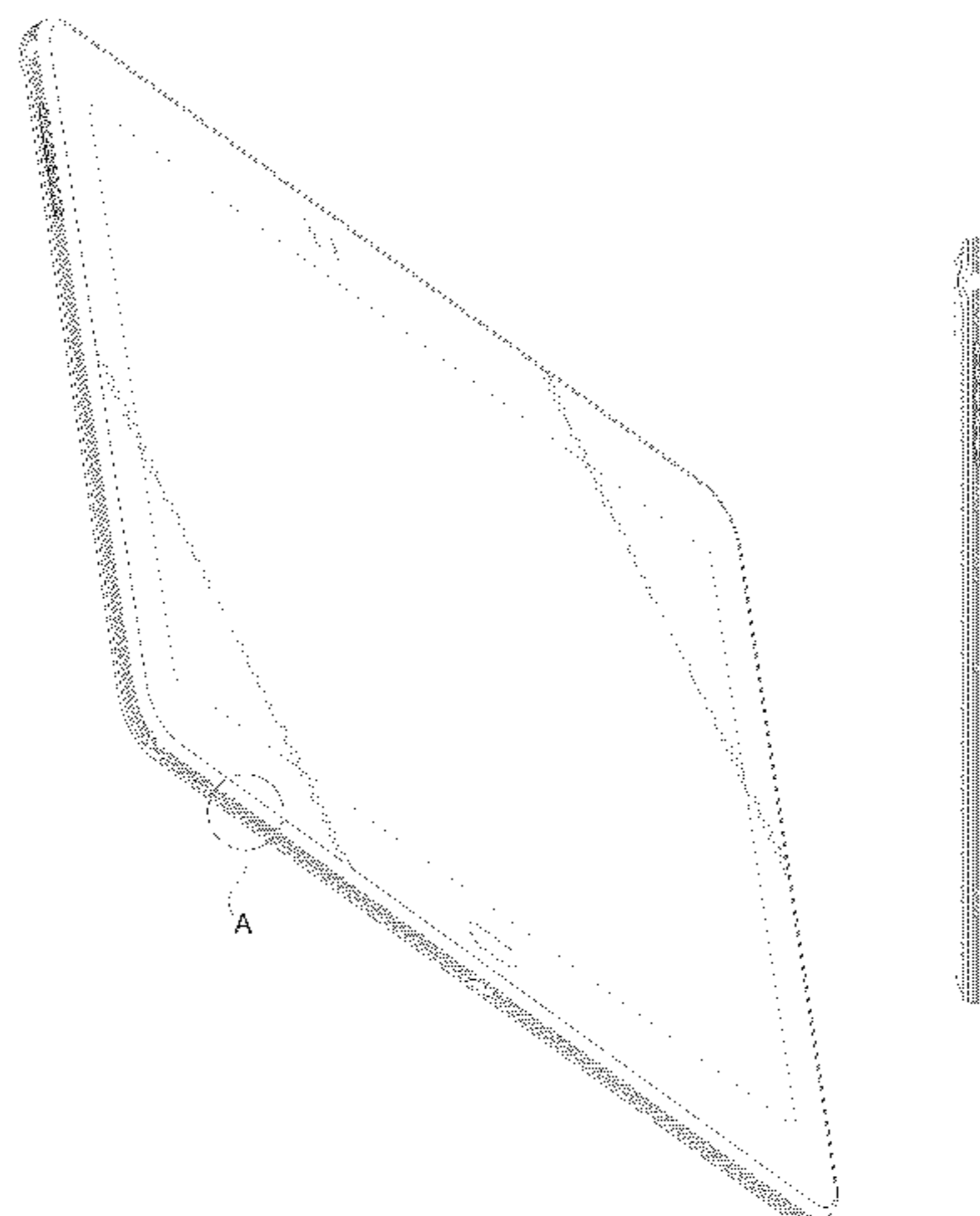

(56)

**References Cited**

U.S. PATENT DOCUMENTS

D500,749 S \* 1/2005 Kim ..... D14/138 AA  
 D546,314 S \* 7/2007 Im ..... D14/138 AA  
 D608,328 S \* 1/2010 Nilsen et al. .... D14/138 AA  
 D612,826 S \* 3/2010 Lee et al. .... D14/138 G  
 D617,300 S \* 6/2010 Tzeng et al. .... D14/138 AA  
 D635,567 S \* 4/2011 Rashid et al. .... D14/341  
 D636,769 S \* 4/2011 Wood et al. .... D14/341  
 D645,491 S \* 9/2011 Lee ..... D16/225  
 D650,780 S \* 12/2011 Rashid et al. .... D14/341  
 D652,418 S \* 1/2012 Rashid et al. .... D14/341  
 D659,134 S \* 5/2012 Ahn et al. .... D14/318  
 D691,189 S \* 10/2013 Zhao ..... D16/230  
 D693,785 S \* 11/2013 Sutherland et al. .... D14/138 G  
 D705,776 S \* 5/2014 Groene et al. .... D14/341  
 D705,777 S \* 5/2014 Groene et al. .... D14/341  
 D710,841 S \* 8/2014 Akana et al. .... D14/318

D712,400 S \* 9/2014 Kim et al. .... D14/341  
 D715,795 S \* 10/2014 McManigal ..... D14/341  
 D716,293 S \* 10/2014 Hwang et al. .... D14/341  
 D717,760 S \* 11/2014 Kim et al. .... D14/138 R  
 2012/0194997 A1 \* 8/2012 McClure et al. .... 361/679.55  
 2012/0194998 A1 \* 8/2012 McClure et al. .... 361/679.56  
 2012/0229973 A1 \* 9/2012 Ting ..... 361/679.56  
 2014/0307393 A1 \* 10/2014 Park et al. .... 361/727  
 2014/0347804 A1 \* 11/2014 Fu et al. .... 361/679.26  
 2015/0049029 A1 \* 2/2015 Yang et al. .... 345/173  
 2015/0049065 A1 \* 2/2015 Chen ..... 345/179

OTHER PUBLICATIONS

Samsung Chromebook (Time), available Mar. 3, 2014, [online], [site visited Apr. 29, 2015]. Available from internet, <URL: <http://time.com/11601/samsung-chromebook-2/#11601/samsung-chromebook-2/>>.\*

\* cited by examiner

FIG.1

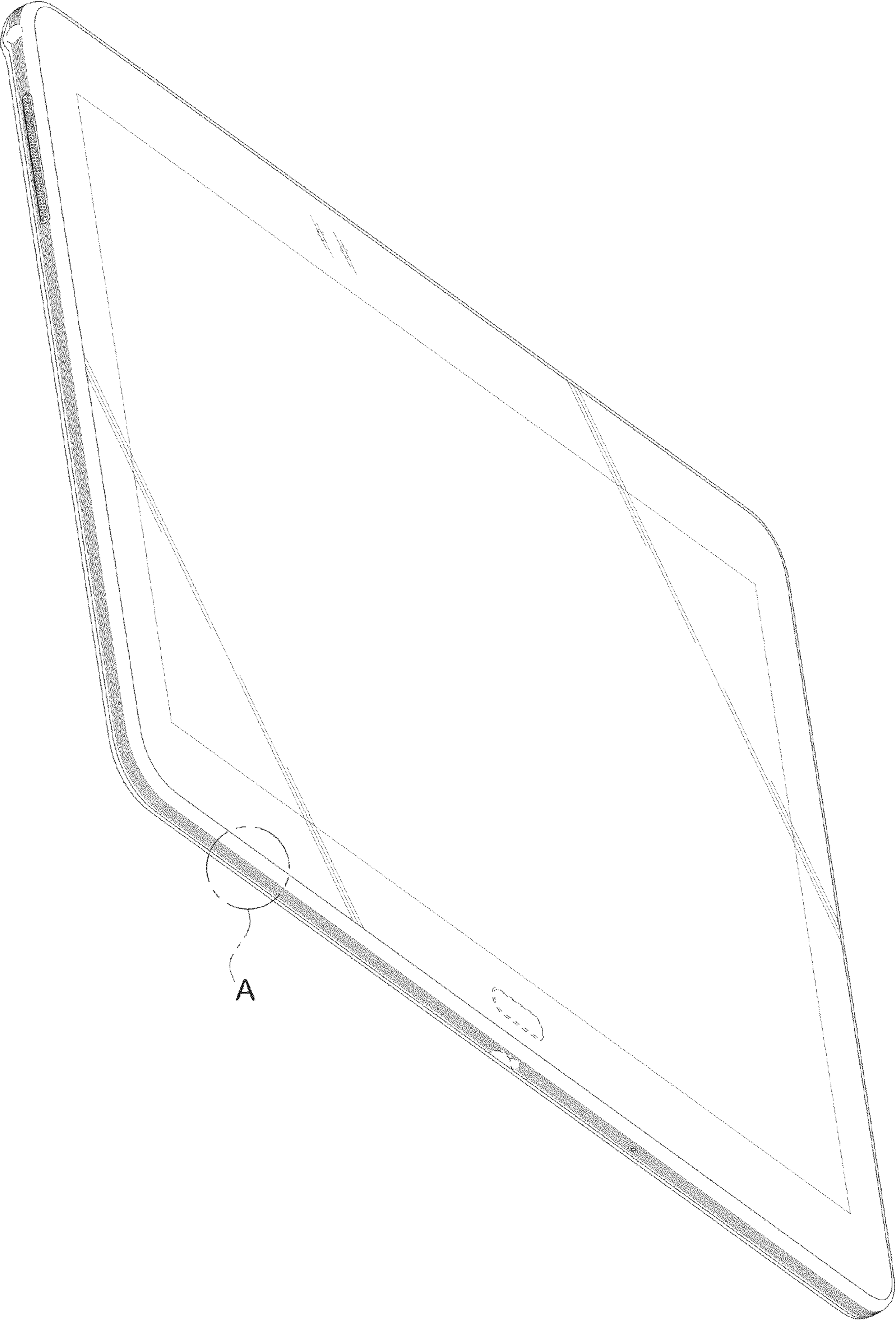
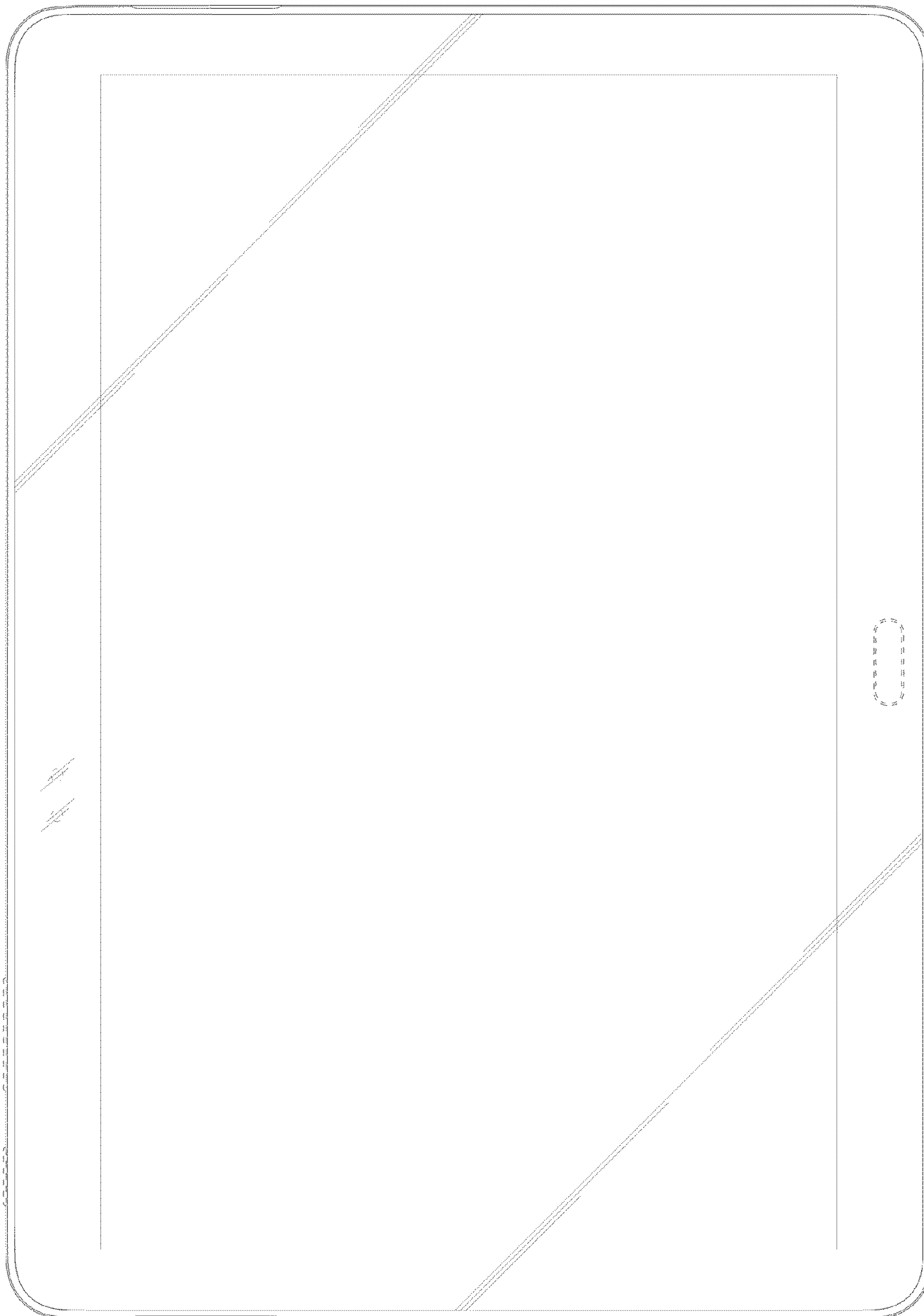

FIG.2





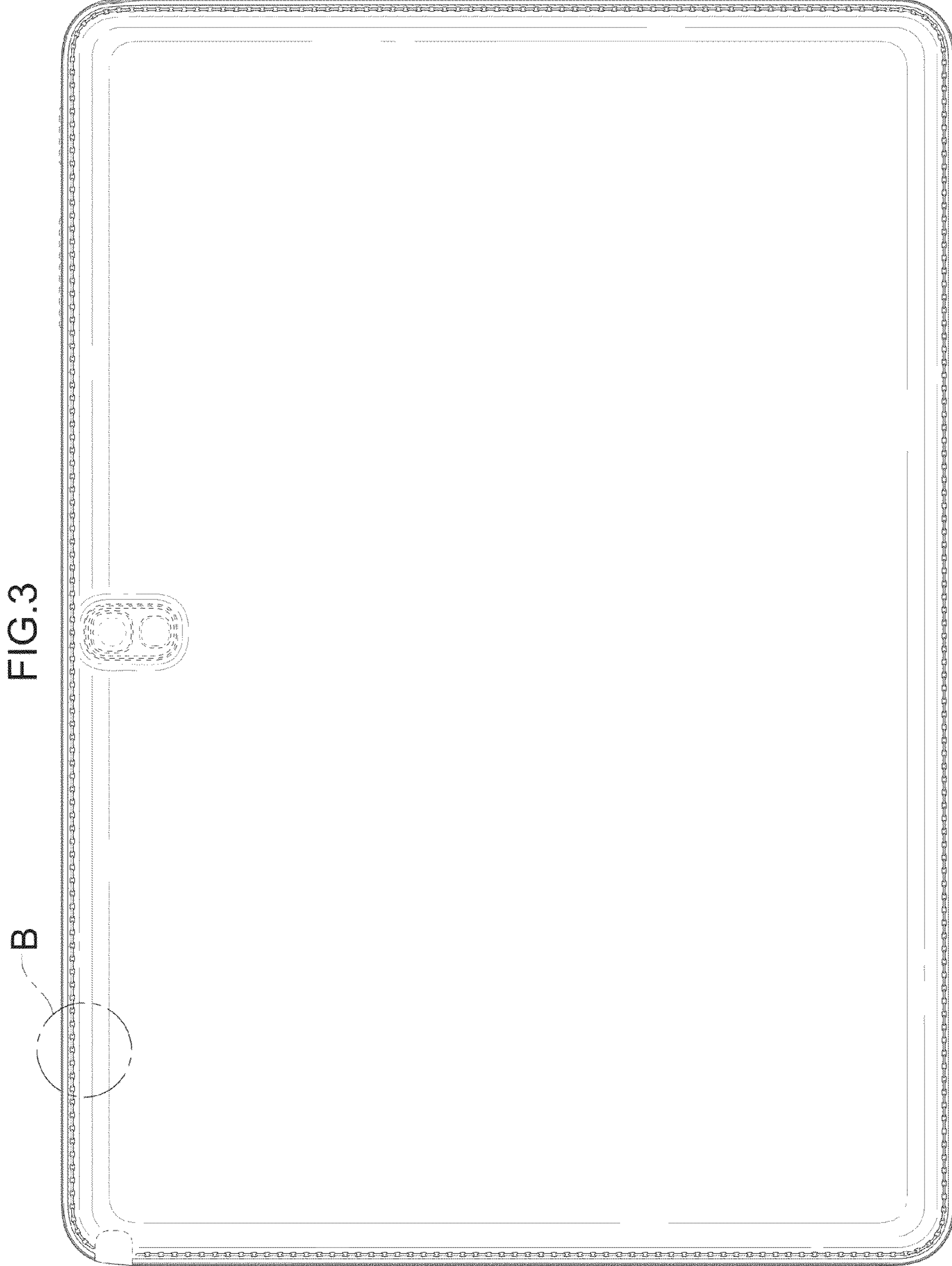

FIG.5

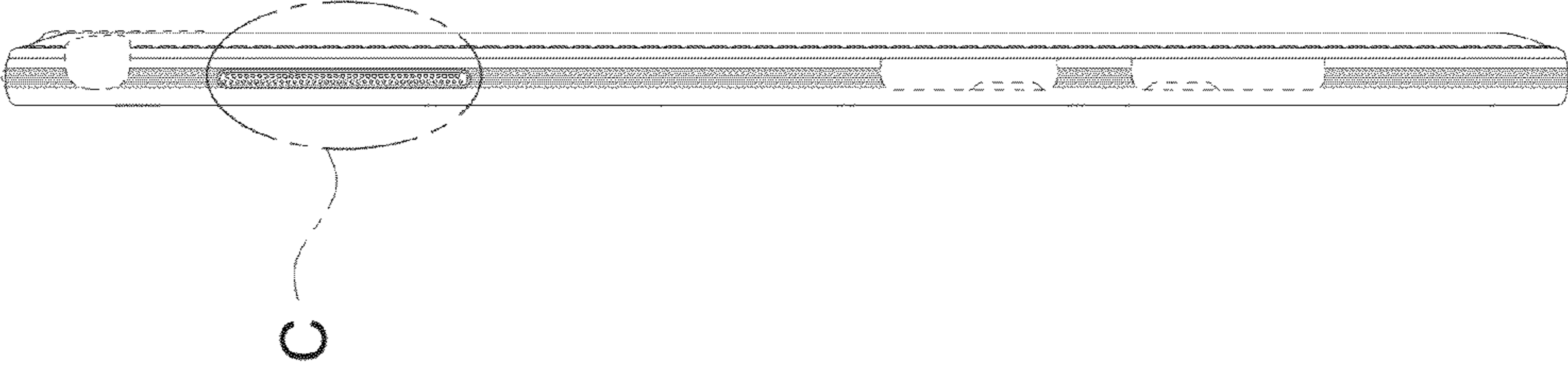

FIG.4



FIG.6

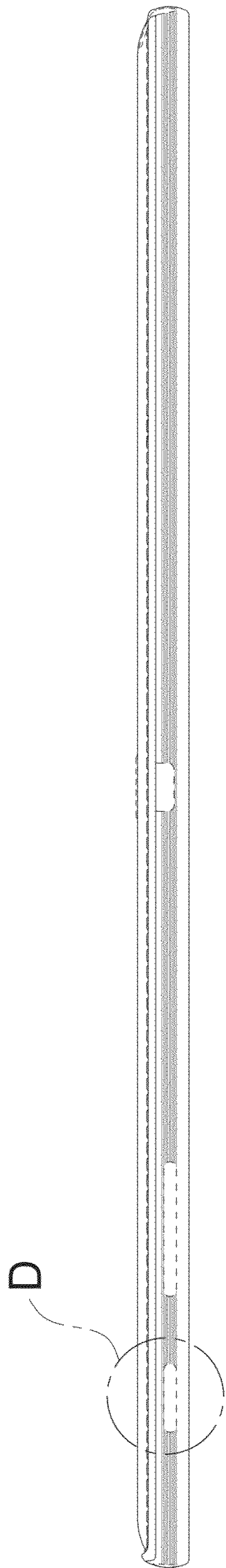

FIG.7

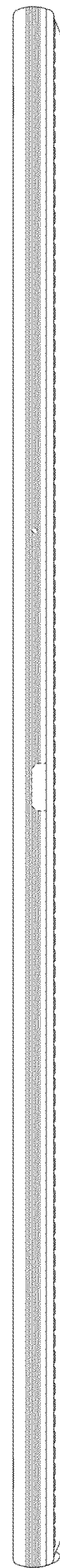

FIG.8

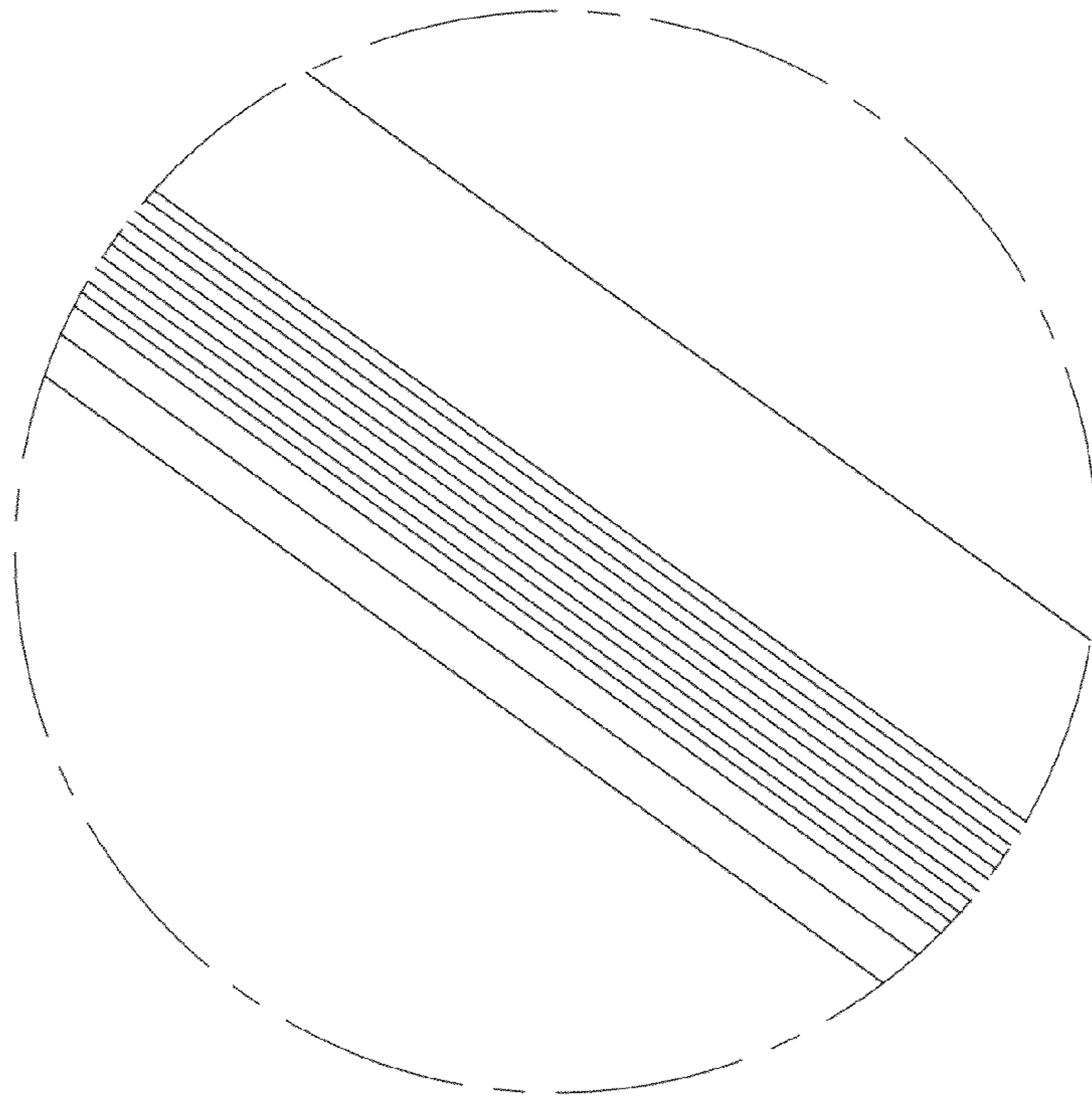

FIG.9

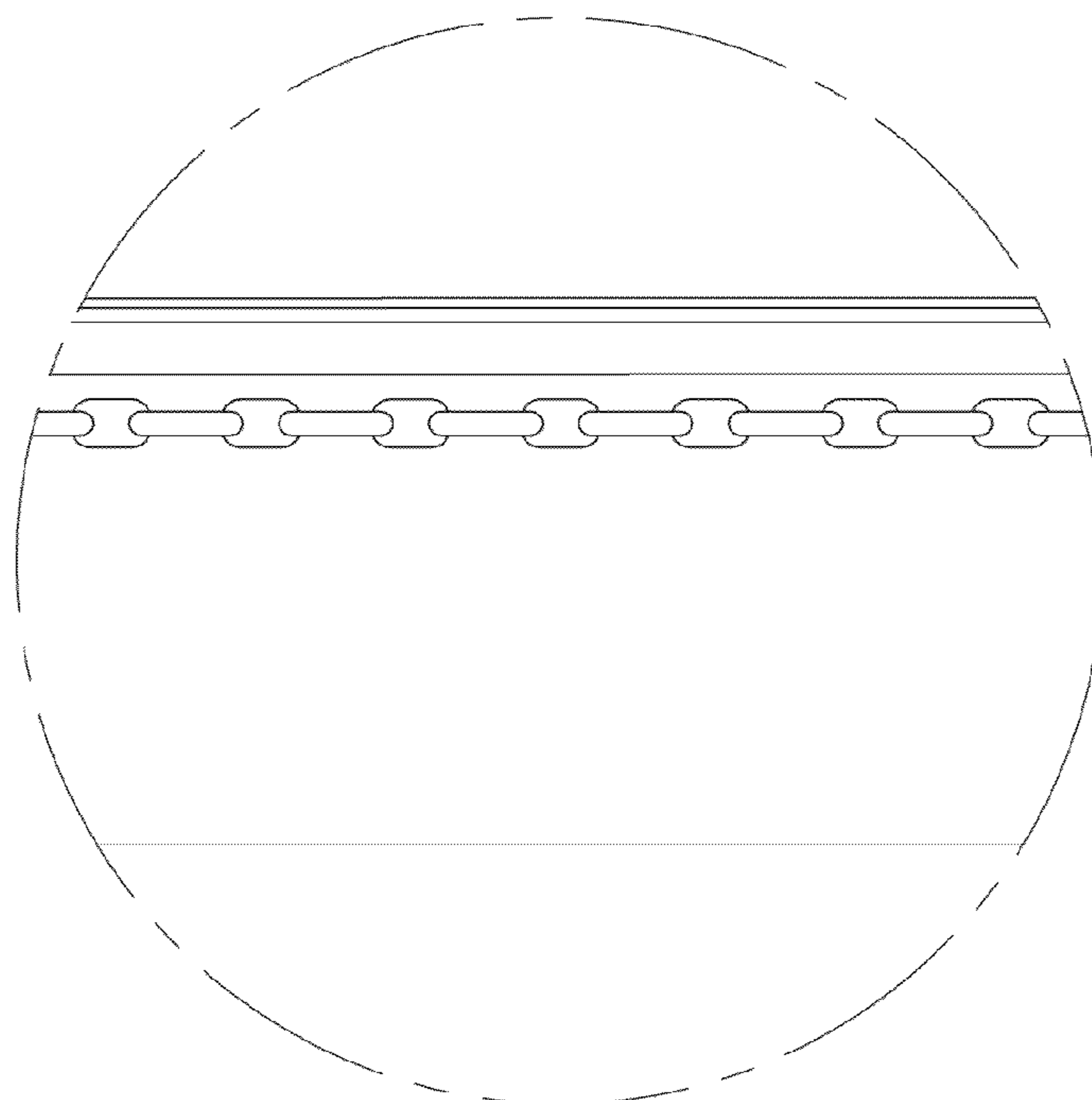



FIG.10

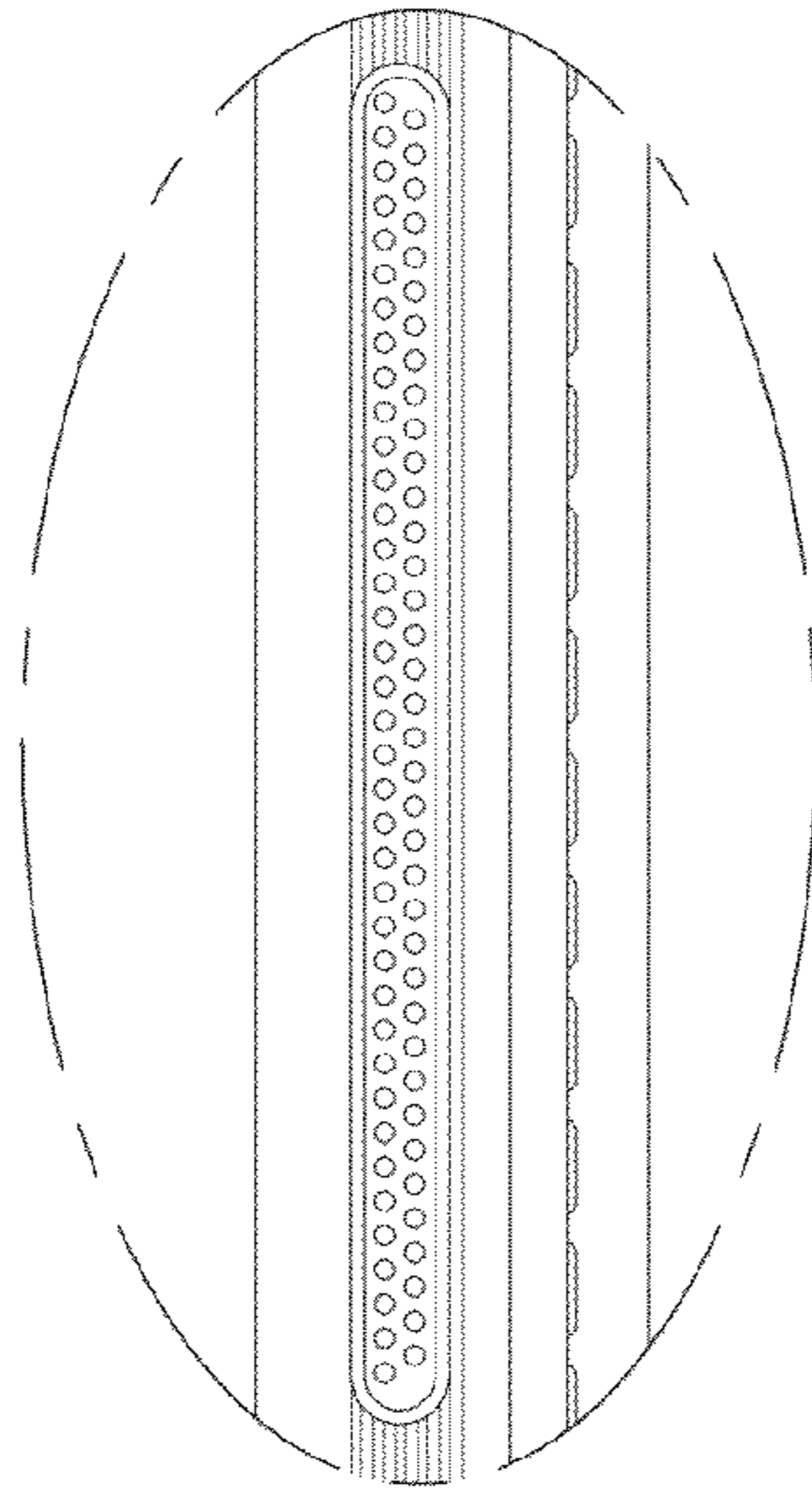

FIG.11

