



US00D743904S

(12) **United States Design Patent**
Kobuchi et al.

(10) **Patent No.:** **US D743,904 S**

(45) **Date of Patent:** **** Nov. 24, 2015**

(54) **ELECTRICAL CONNECTOR**

(71) Applicant: **Japan Aviation Electronics Industry, Limited, Tokyo (JP)**

(72) Inventors: **Toshiro Kobuchi, Tokyo (JP); Yoshinori Honma, Tokyo (JP); Takayuki Nishimura, Tokyo (JP); Hiroaki Obikane, Tokyo (JP)**

(73) Assignee: **Japan Aviation Electronic Industry, Limited, Tokyo (JP)**

(**) Term: **14 Years**

(21) Appl. No.: **29/511,626**

(22) Filed: **Dec. 12, 2014**

(30) **Foreign Application Priority Data**

Jun. 30, 2014 (JP) 2014-014361

(51) **LOC (10) Cl.** **13-03**

(52) **U.S. Cl.**
USPC **D13/147**

(58) **Field of Classification Search**
USPC D13/133, 146, 147, 154, 184, 199
See application file for complete search history.

(56) **References Cited**

U.S. PATENT DOCUMENTS

D603,799 S	11/2009	Obikane et al.	
D641,705 S	7/2011	Sato et al.	
D642,531 S	8/2011	Nishimura et al.	
D642,534 S *	8/2011	Okibane	D13/147
D684,541 S *	6/2013	Miyazaki et al.	D13/147
D684,932 S	6/2013	Nishimura et al.	
D695,692 S	12/2013	Takenaga et al.	
D733,058 S *	6/2015	Miyazaki	D13/147
D737,781 S *	9/2015	Yoshioka	D13/147
D738,316 S *	9/2015	Yoshioka	D13/147

* cited by examiner

Primary Examiner — Daniel Bui
(74) *Attorney, Agent, or Firm* — Cermak Nakajima & McGowan LLP; Tomoko Nakajima

(57) **CLAIM**

The ornamental design for an electrical connector, as shown.

DESCRIPTION

FIG. 1 is a front elevational view of an electrical connector showing our new design;
FIG. 2 is a top plan view thereof;
FIG. 3 is a right side elevational view thereof;
FIG. 4 is a left side elevational view thereof;
FIG. 5 is a rear elevational view thereof;
FIG. 6 is a bottom plan view thereof;
FIG. 7 is a front and top perspective view thereof; and,
FIG. 8 is a front and bottom perspective view thereof.

1 Claim, 8 Drawing Sheets

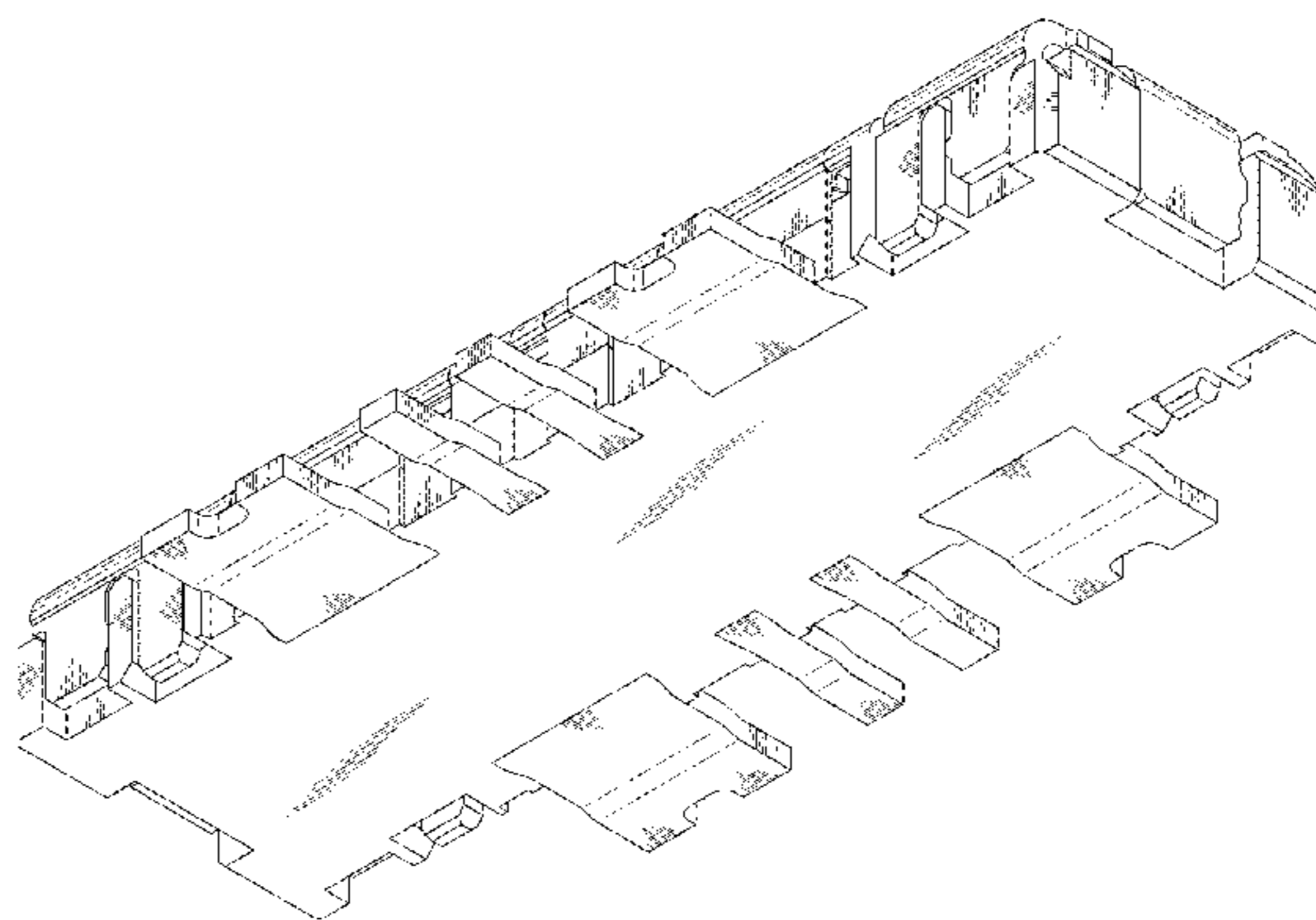
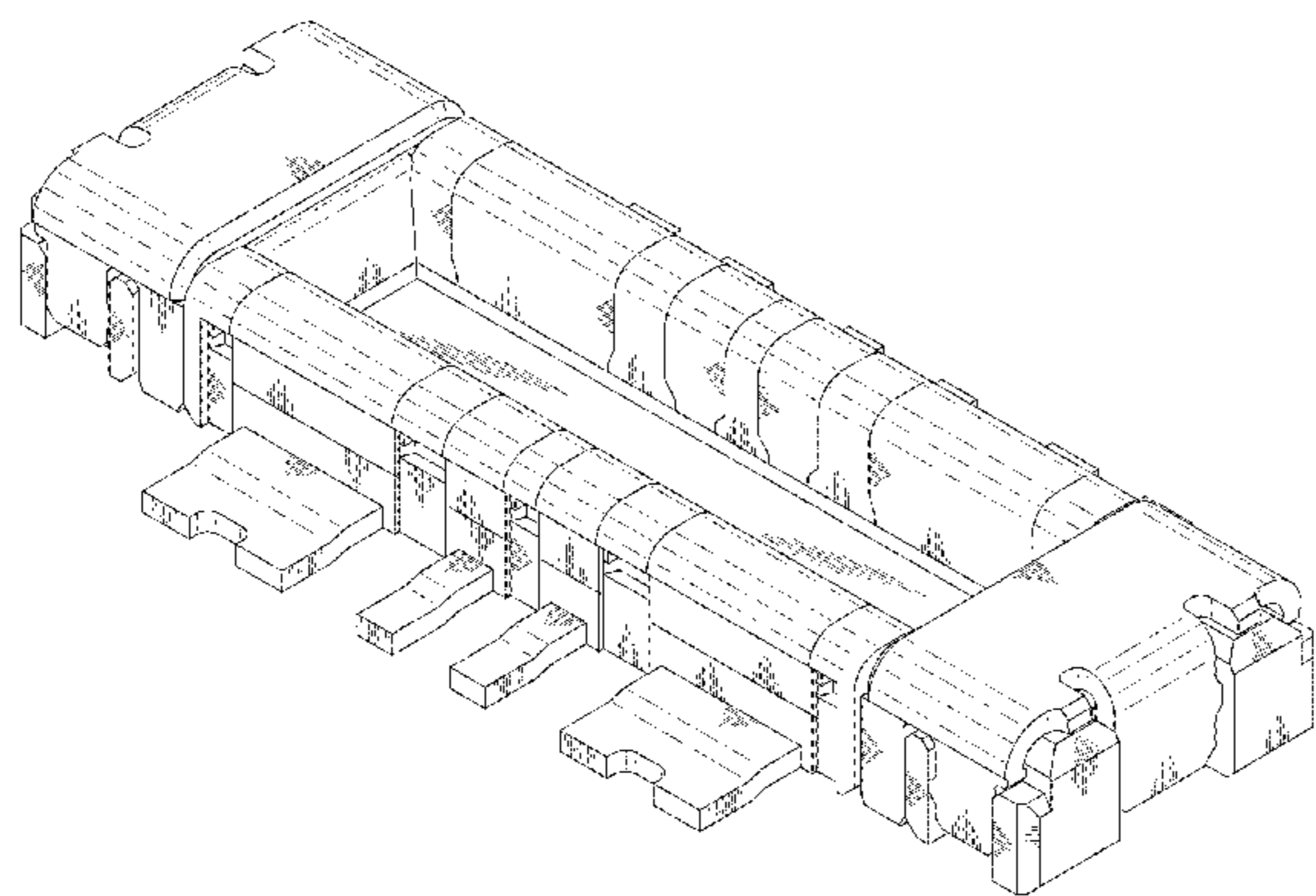

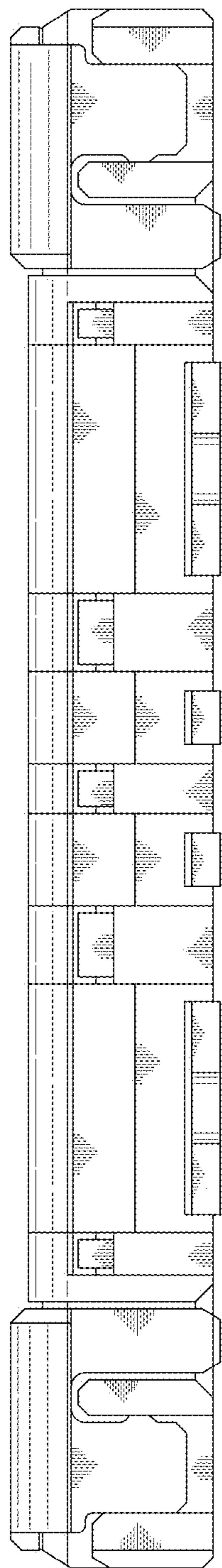

FIG.1

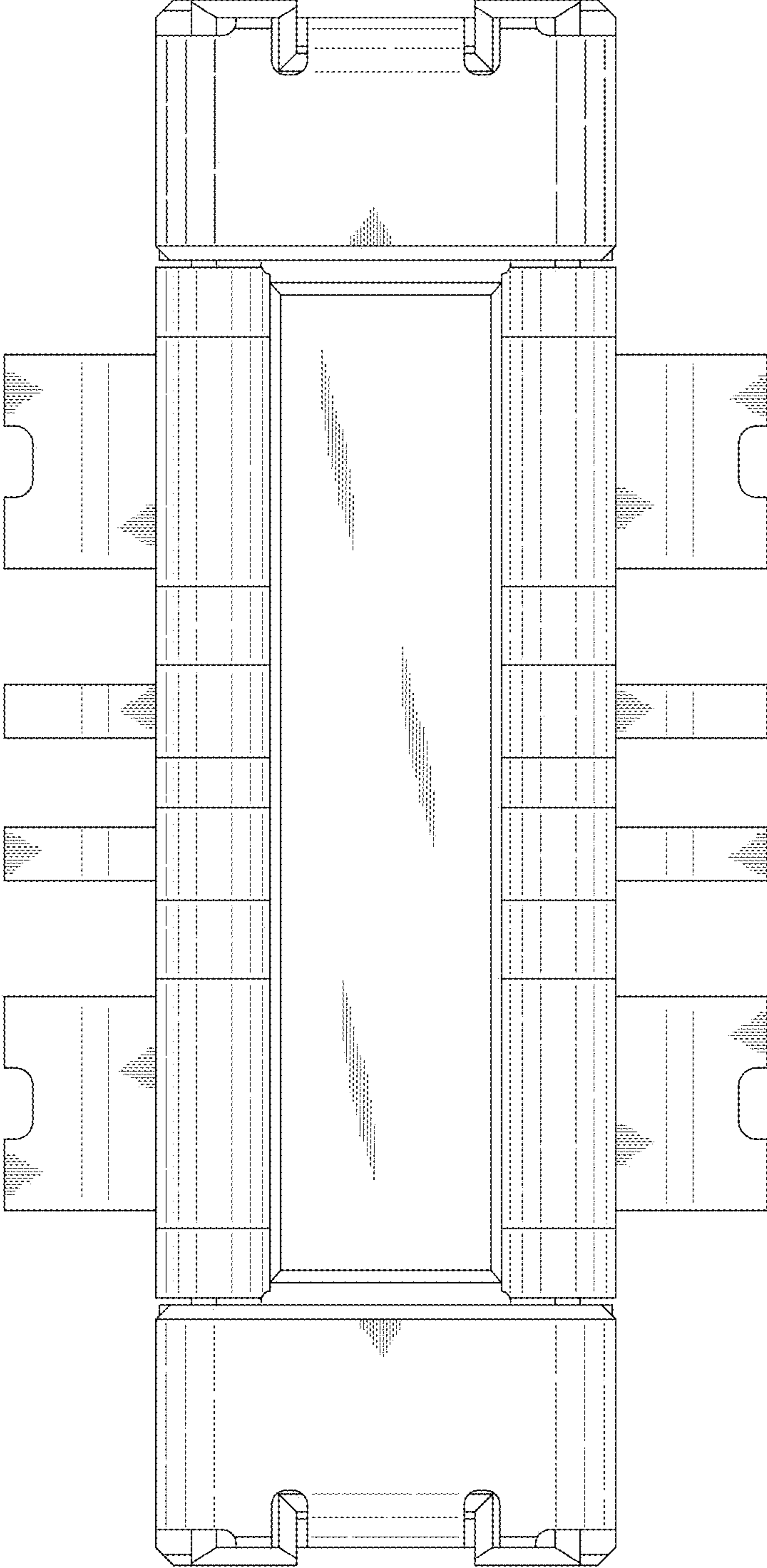

FIG.2

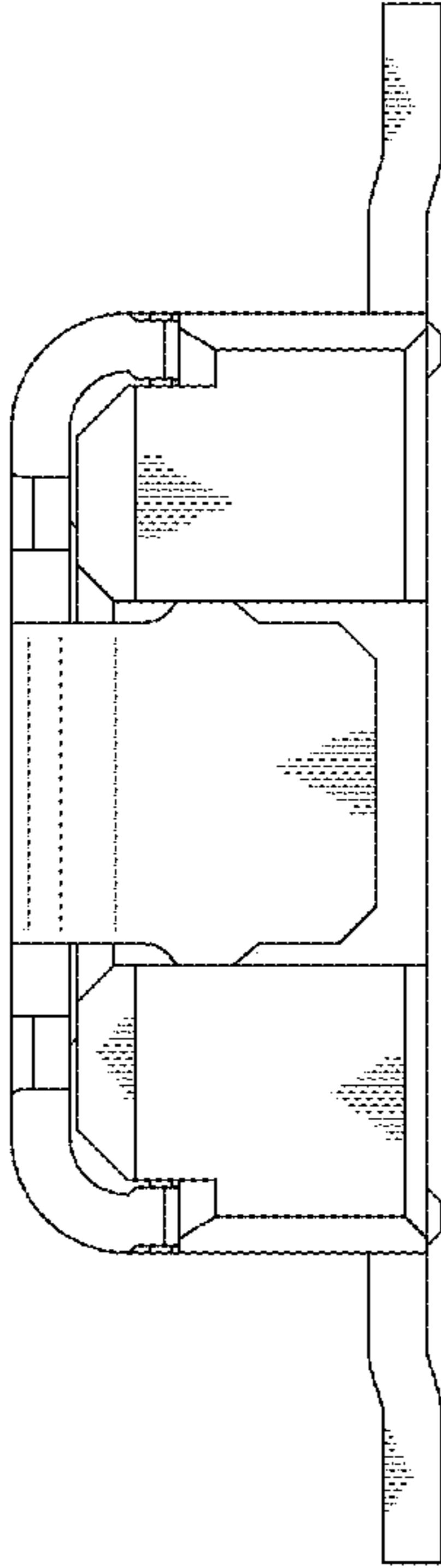

FIG.3

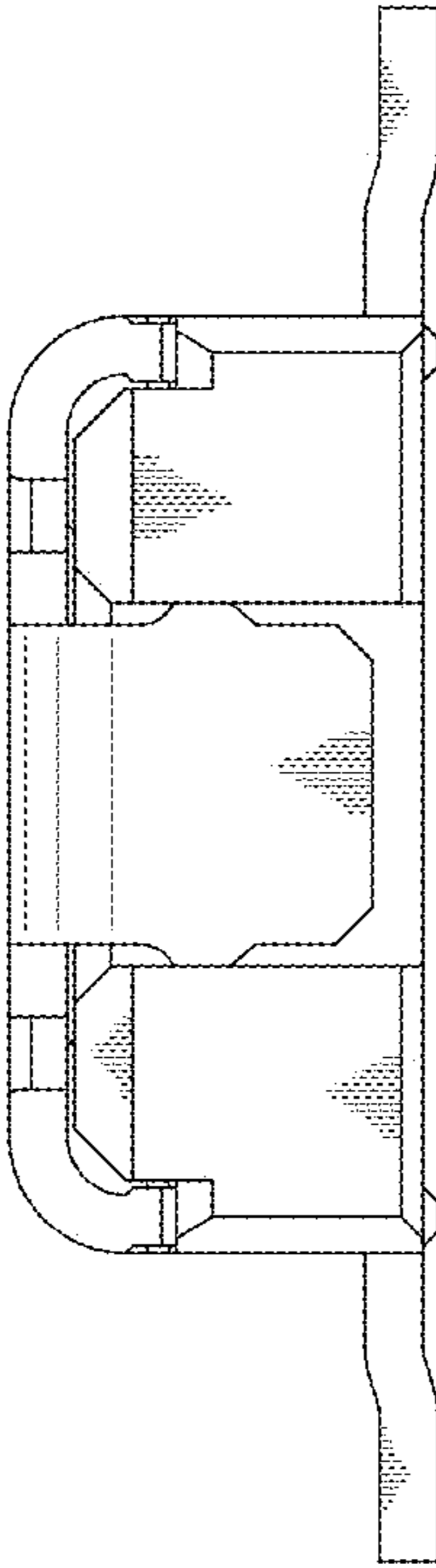

FIG.4

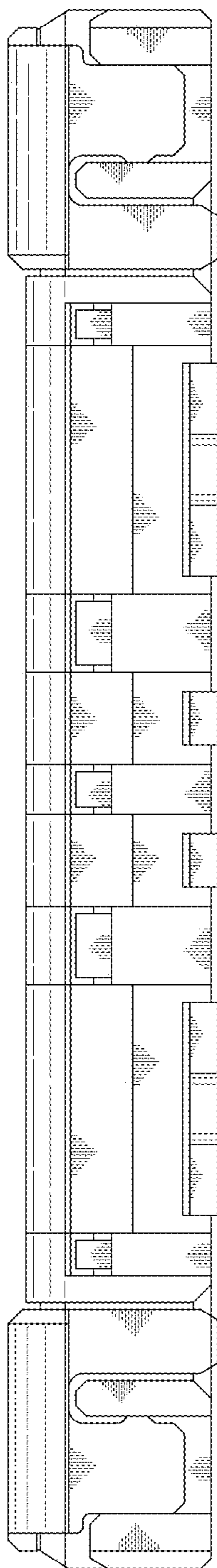

FIG. 5

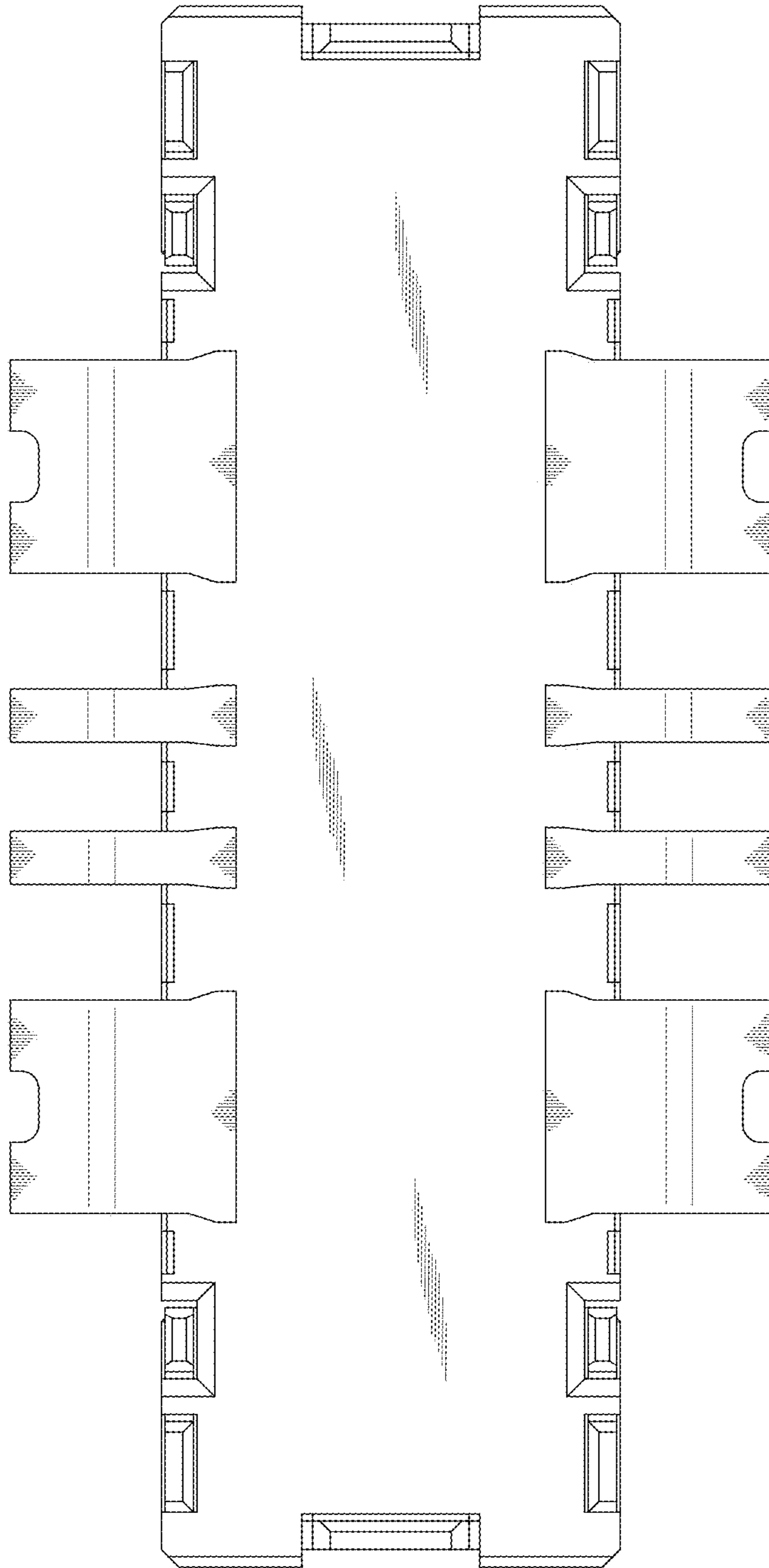

FIG.6

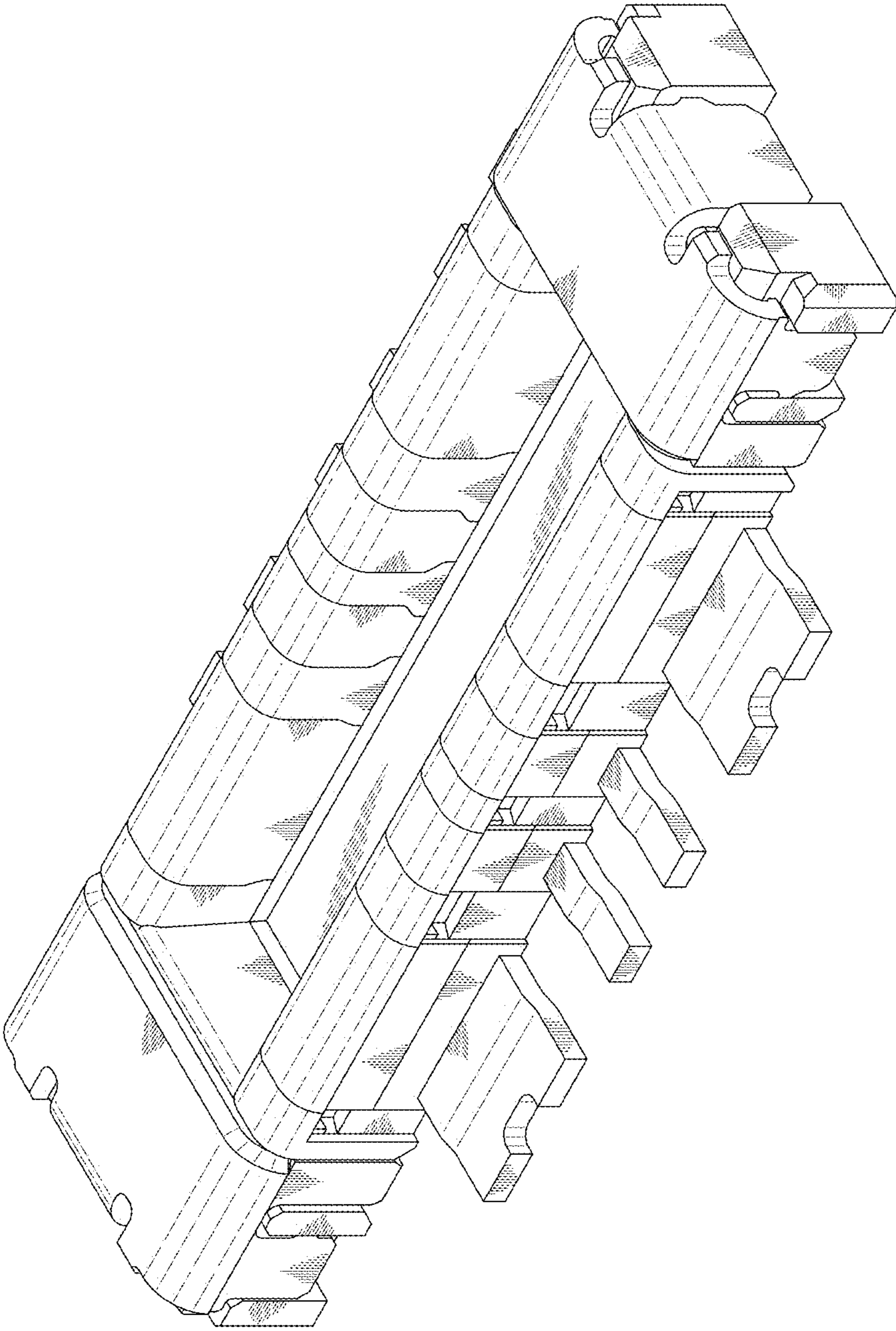

FIG.7

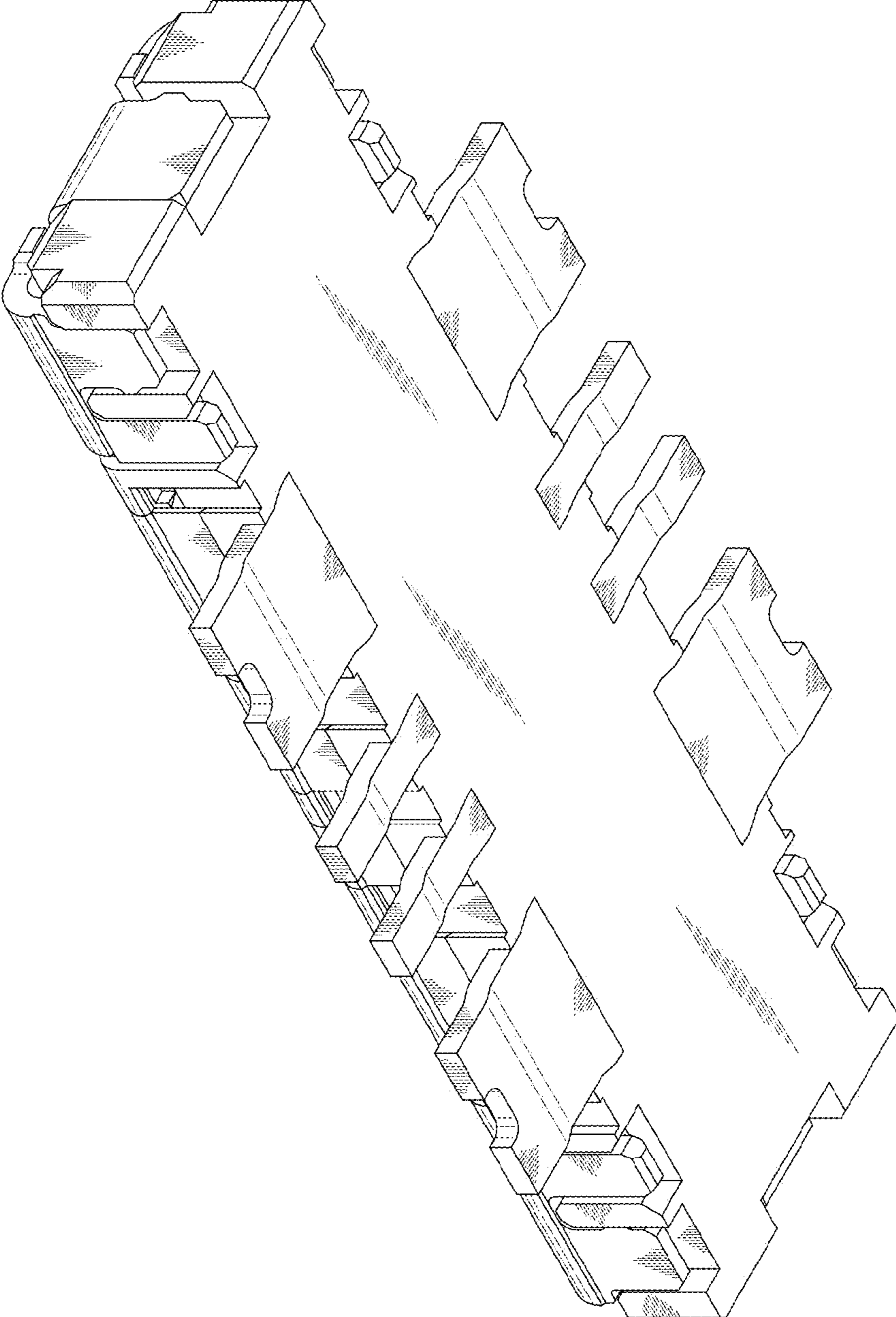

FIG.8