



US00D743870S

(12) **United States Design Patent**
Galley et al.

(10) **Patent No.:** **US D743,870 S**

(45) **Date of Patent:** **** Nov. 24, 2015**

(54) **ANGLED RACK**

(71) Applicants: **Thomas C. Galley**, Sedalia, CO (US);
Derek T. Galley, Parker, CO (US)

(72) Inventors: **Thomas C. Galley**, Sedalia, CO (US);
Derek T. Galley, Parker, CO (US)

(**) Term: **14 Years**

(21) Appl. No.: **29/473,838**

(22) Filed: **Nov. 26, 2013**

(51) **LOC (10) Cl.** **12-16**

(52) **U.S. Cl.**
USPC **D12/406**

(58) **Field of Classification Search**
USPC D12/401-414; D6/610-611
CPC B60R 9/00; B60R 9/02; B60R 9/04;
B60R 9/08; B60R 9/042; B60R 9/0423;
B60R 9/0426; B60R 9/045; B60R 9/048;
B60R 9/0485; B60R 9/05; B60R 9/052;
B60R 9/055; B60R 9/058; B60R 9/06; B60R
9/065; B60R 9/10; B60R 9/12
See application file for complete search history.

(56) **References Cited**

U.S. PATENT DOCUMENTS

D268,830 S * 5/1983 Sutela D12/93
D417,172 S * 11/1999 Smith et al. D12/101
6,254,117 B1 * 7/2001 Cross 280/401

D459,287 S * 6/2002 Beard et al. D12/406
D593,927 S * 6/2009 Walton et al. D12/406
D660,748 S * 5/2012 Cooley D12/101
D691,518 S * 10/2013 Monia et al. D12/101
D713,775 S * 9/2014 Lagermann D12/406

* cited by examiner

Primary Examiner — Katrina A Betton

(74) *Attorney, Agent, or Firm* — Patent Law Offices of Rick Martin, P.C.

(57) **CLAIM**

The ornamental design for an angled rack, as shown and described.

DESCRIPTION

FIG. 1 is a rear perspective view of my new design for an angled rack;
FIG. 2 is a front elevation view of my new invention;
FIG. 3 is a rear elevation view of my new invention;
FIG. 4 is a top plan view of my new invention;
FIG. 5 is a bottom plan view of my new invention;
FIG. 6 is a left side elevation view of my new invention, wherein a right side elevation view is a mirror image thereof; and,
FIG. 7 is a left side perspective view of my new invention.
The broken lines indicating feet and an off road vehicle are for the purposes of illustration and form no part of the claimed design.

1 Claim, 4 Drawing Sheets

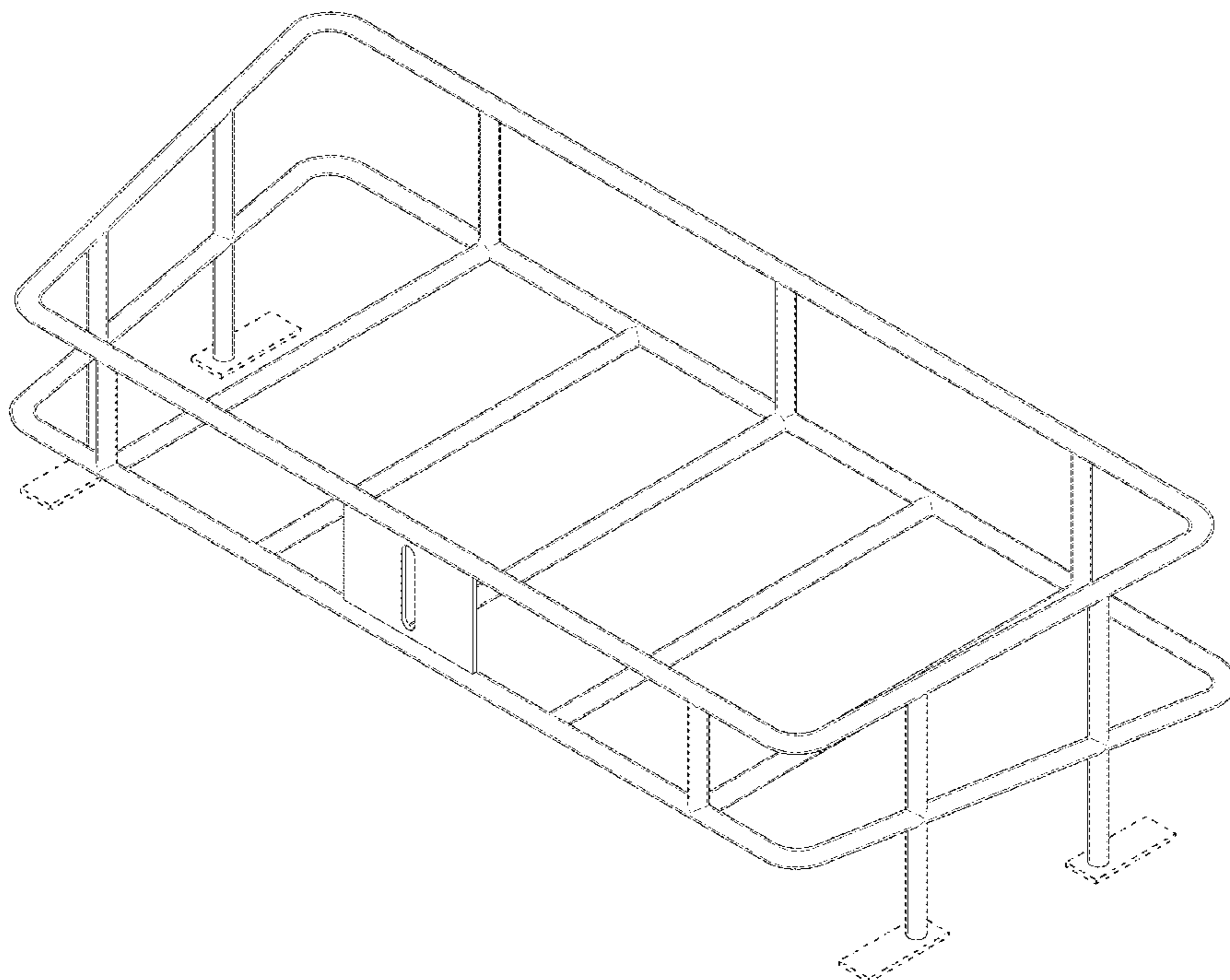

Fig. 1

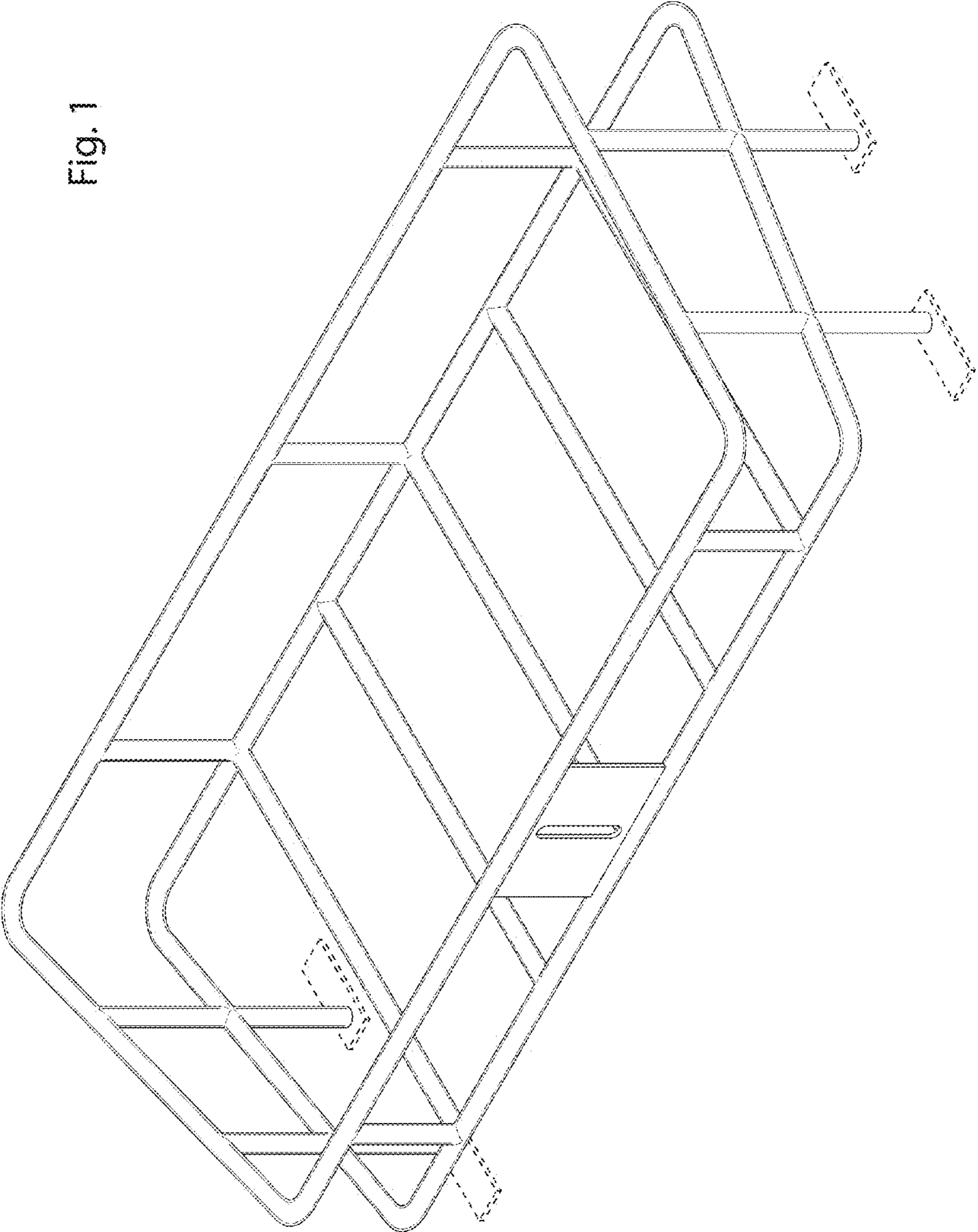

Fig. 2

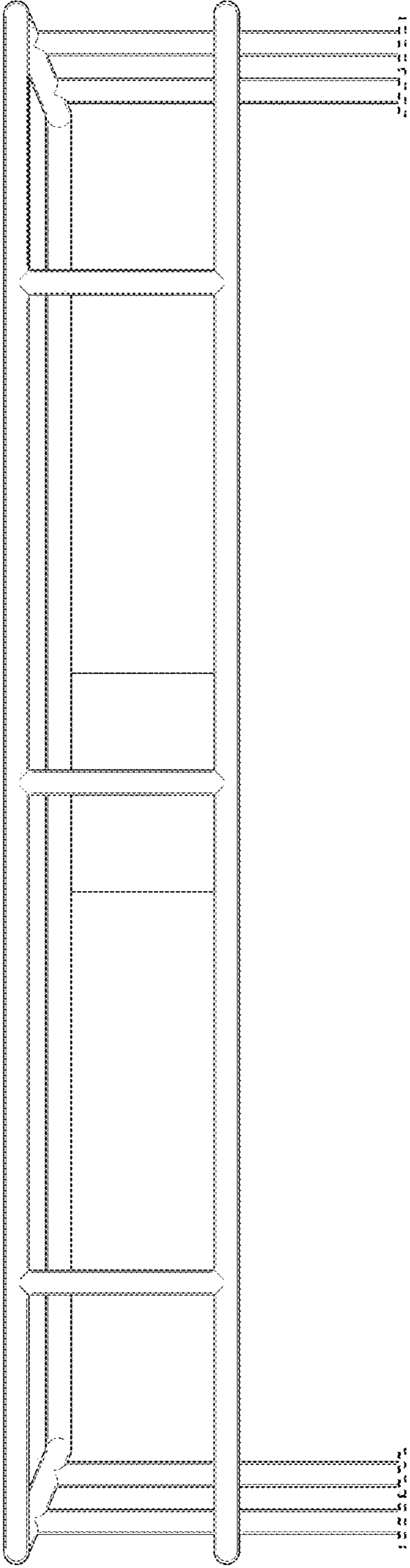

Fig. 3

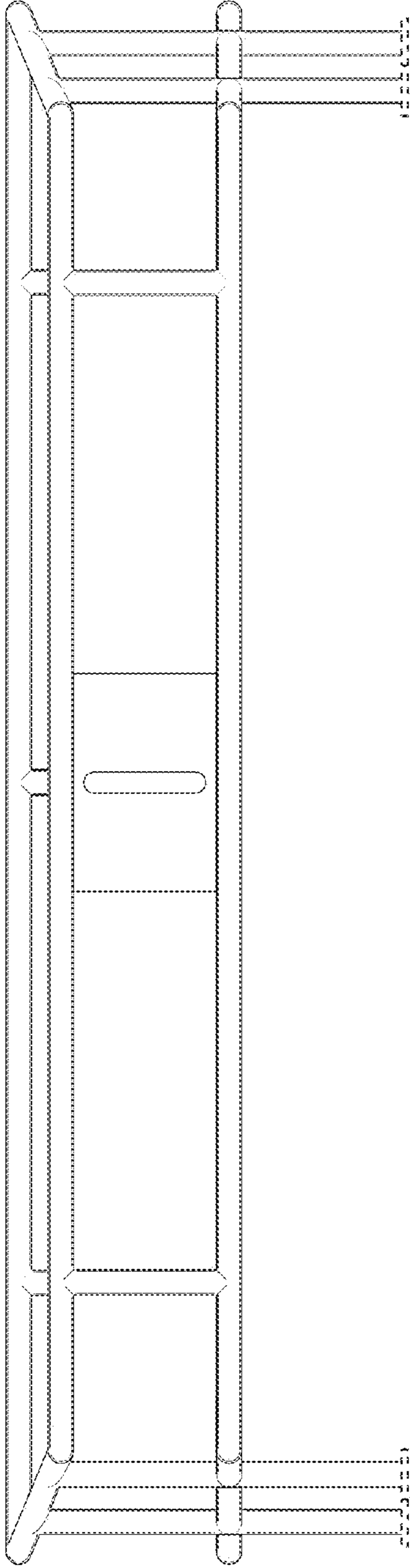

Fig. 4

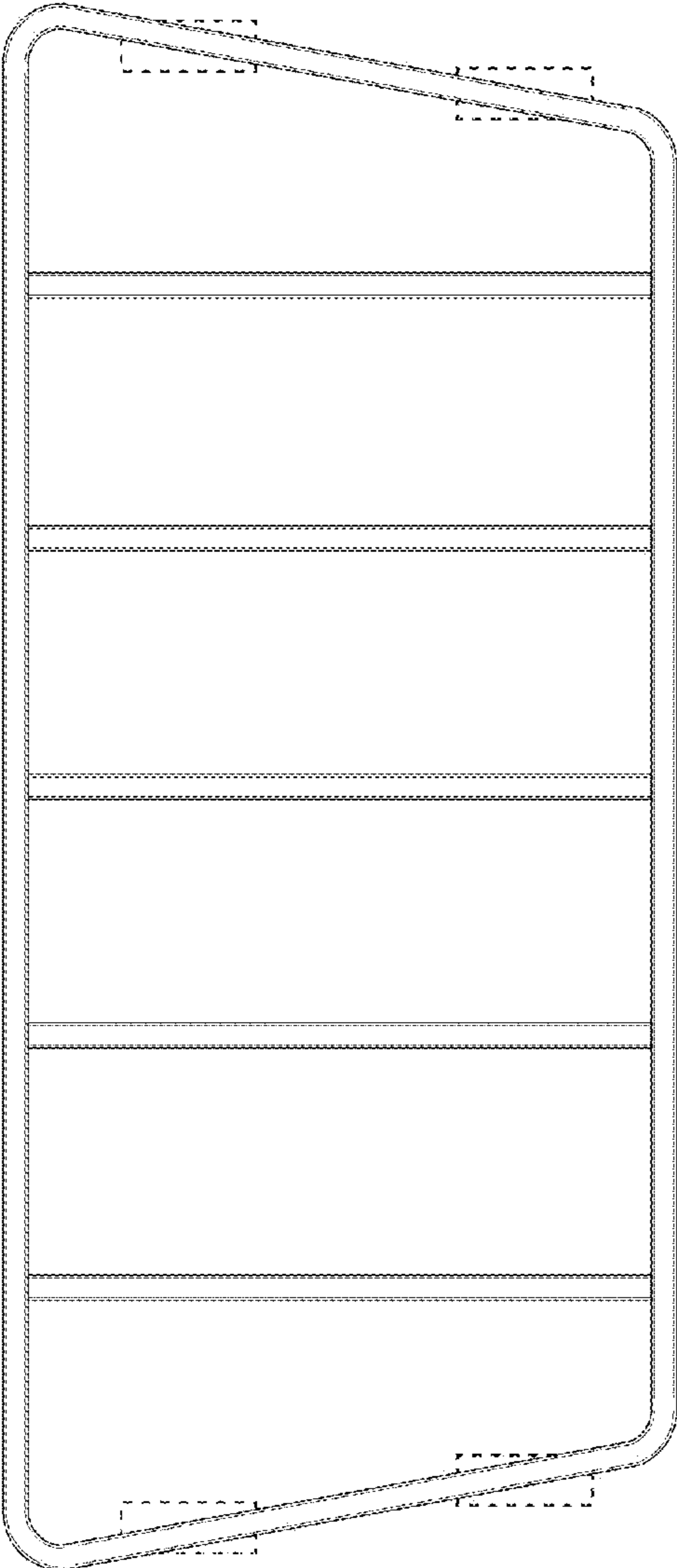

Fig. 5

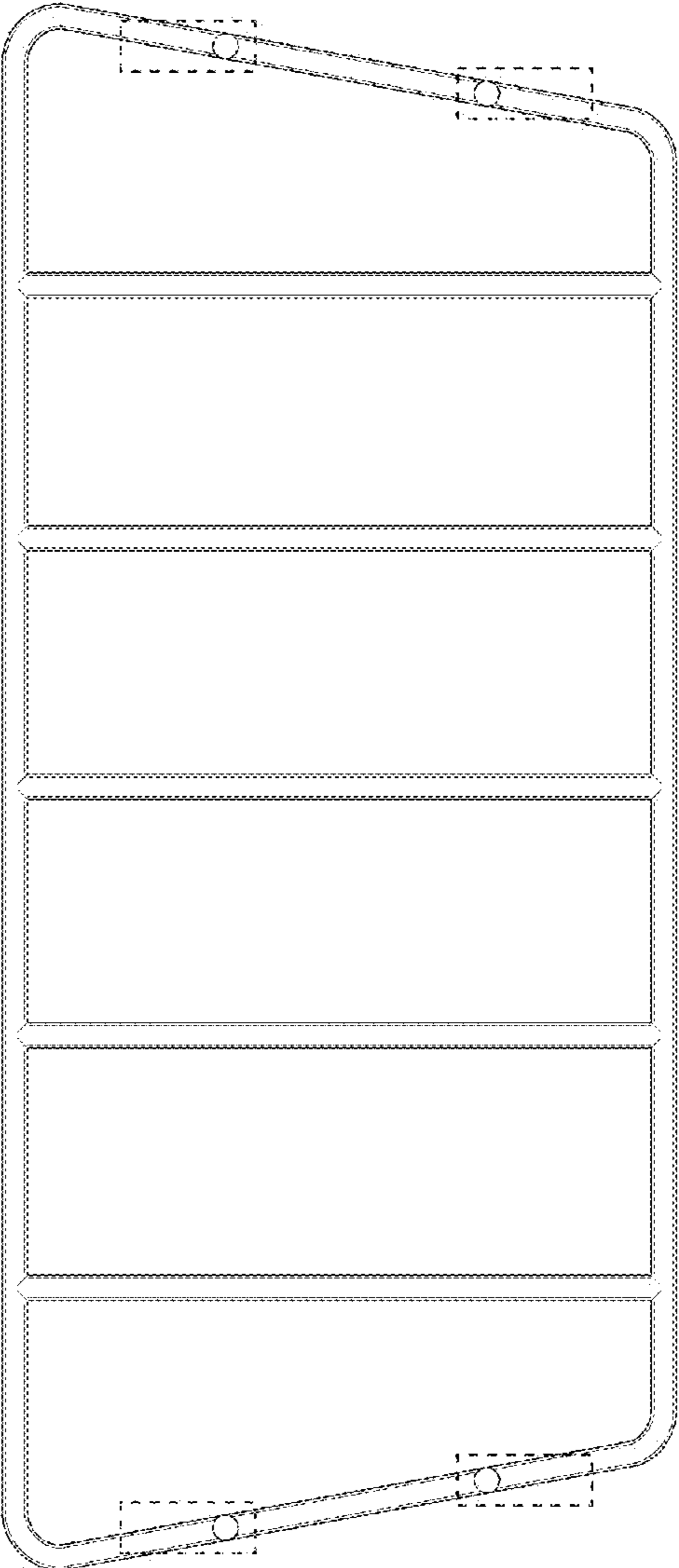

Fig. 6

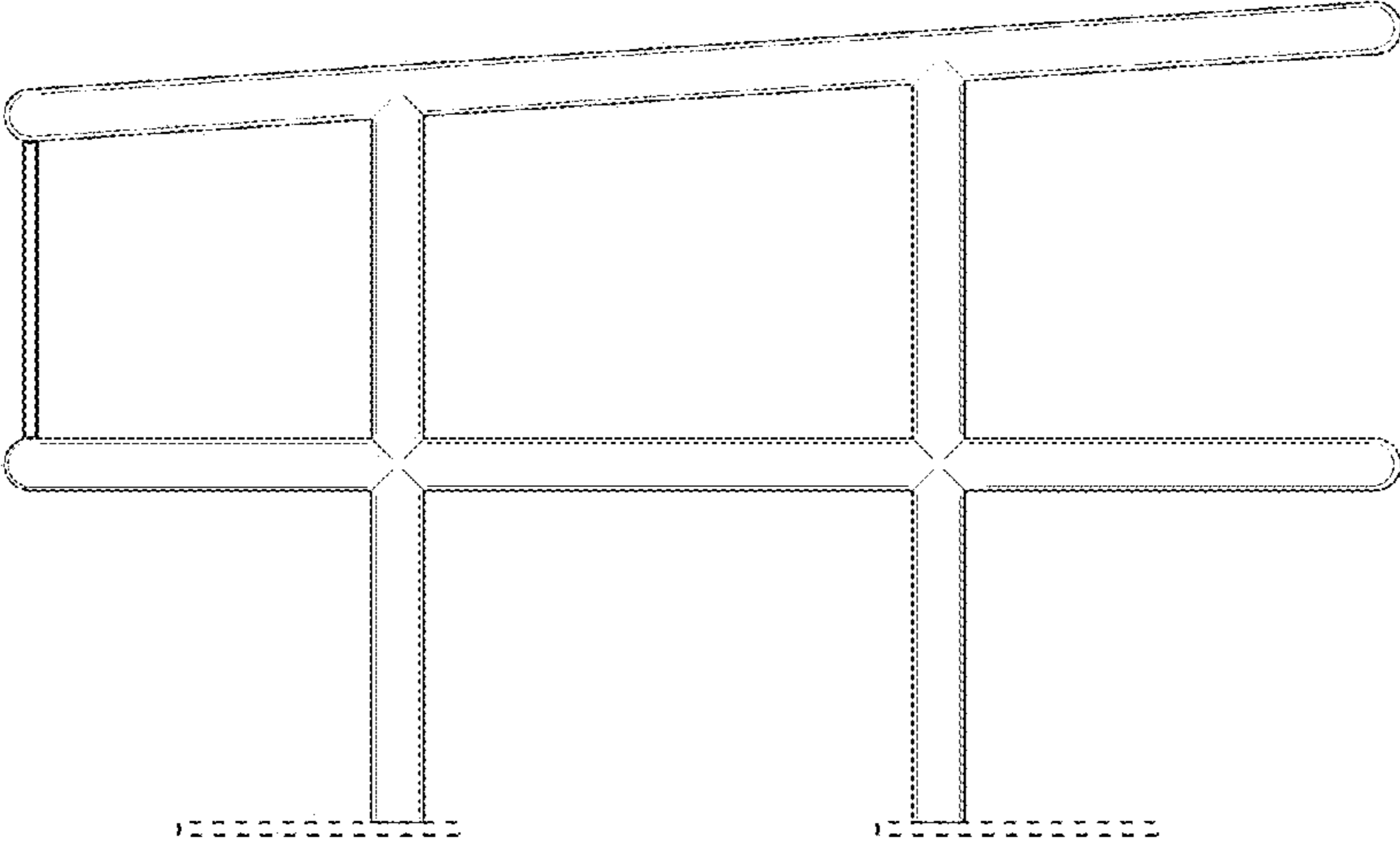

Fig. 7

