



US00D743866S

(12) **United States Design Patent**  
**Carlson**

(10) **Patent No.:** **US D743,866 S**

(45) **Date of Patent:** **\*\* Nov. 24, 2015**

- (54) **WATER INTAKE GRILL**
- (71) Applicant: **Morley Richard Carlson**, Albertville, MN (US)
- (72) Inventor: **Morley Richard Carlson**, Albertville, MN (US)
- (\*\*) Term: **14 Years**
- (21) Appl. No.: **29/500,527**
- (22) Filed: **Aug. 26, 2014**
- (51) **LOC (10) Cl.** ..... **12-06**
- (52) **U.S. Cl.**  
USPC ..... **D12/317**
- (58) **Field of Classification Search**  
USPC ..... D12/307, 317  
CPC ..... B63H 11/00; B63H 11/01; B63H 11/04;  
B63H 11/08; B63H 11/103  
See application file for complete search history.

5,839,927	A *	11/1998	Thomas et al.	440/43
5,876,258	A *	3/1999	Gray	440/46
6,375,523	B1 *	4/2002	Mathias	440/47
6,855,019	B2 *	2/2005	Fuse et al.	440/47
7,520,789	B1	4/2009	Carlson	
7,794,294	B2	9/2010	Carlson	
8,070,539	B2	12/2011	Carlson	
2010/0330855	A1 *	12/2010	Carlson	440/46

**OTHER PUBLICATIONS**

Stock Intake Grate for 2013-2014 Sea-Doo Spark Model of Personal Watercraft, BRP Corporation, Canada.  
PWC Intake Grates for or by Yamaha, Sofas, UMI Racing, Worx, and R&D Aquavein, Online Product Catalog Search at www.justatv.com, Sep. 1, 2009, (on pp. 1,4-7 of enclosed R2).

\* cited by examiner

*Primary Examiner* — Cynthia M Chin  
(74) *Attorney, Agent, or Firm* — Michael A. Mochinski

(57) **CLAIM**  
The ornamental design for a water intake grill, as shown and described.

**DESCRIPTION**

FIG. 1 is a front perspective view of a water intake grill;  
FIG. 2 is a top plan view thereof;  
FIG. 3 is a bottom plan view thereof;  
FIG. 4 is a rear elevational view thereof;  
FIG. 5 is a front elevational view thereof;  
FIG. 6 is a right side elevational view thereof; and,  
FIG. 7 is a left side elevational view thereof.

**1 Claim, 5 Drawing Sheets**

- (56) **References Cited**  
U.S. PATENT DOCUMENTS
- |           |     |         |              |          |
|-----------|-----|---------|--------------|----------|
| 3,040,695 | A * | 6/1962  | Austin       | 440/46   |
| 3,147,733 | A * | 9/1964  | Engel        | 440/46   |
| 3,253,567 | A * | 5/1966  | Patton, Jr.  | 440/46   |
| 4,027,617 | A * | 6/1977  | Ikeda et al. | 440/46   |
| 4,674,984 | A * | 6/1987  | Caddick      | 440/88 R |
| 5,577,941 | A * | 11/1996 | Chartier     | 440/46   |
| 5,690,520 | A * | 11/1997 | Rheault      | 440/46   |

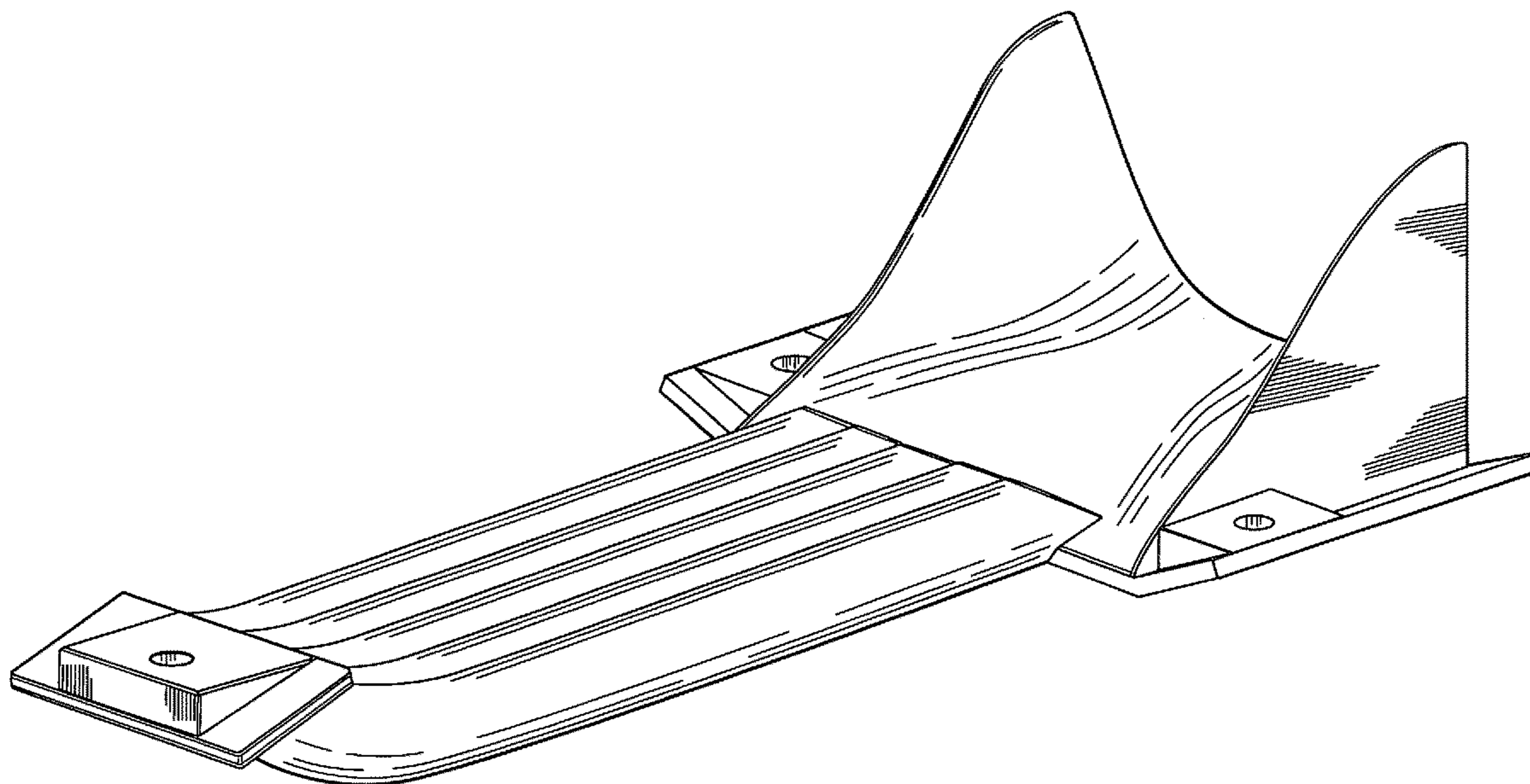

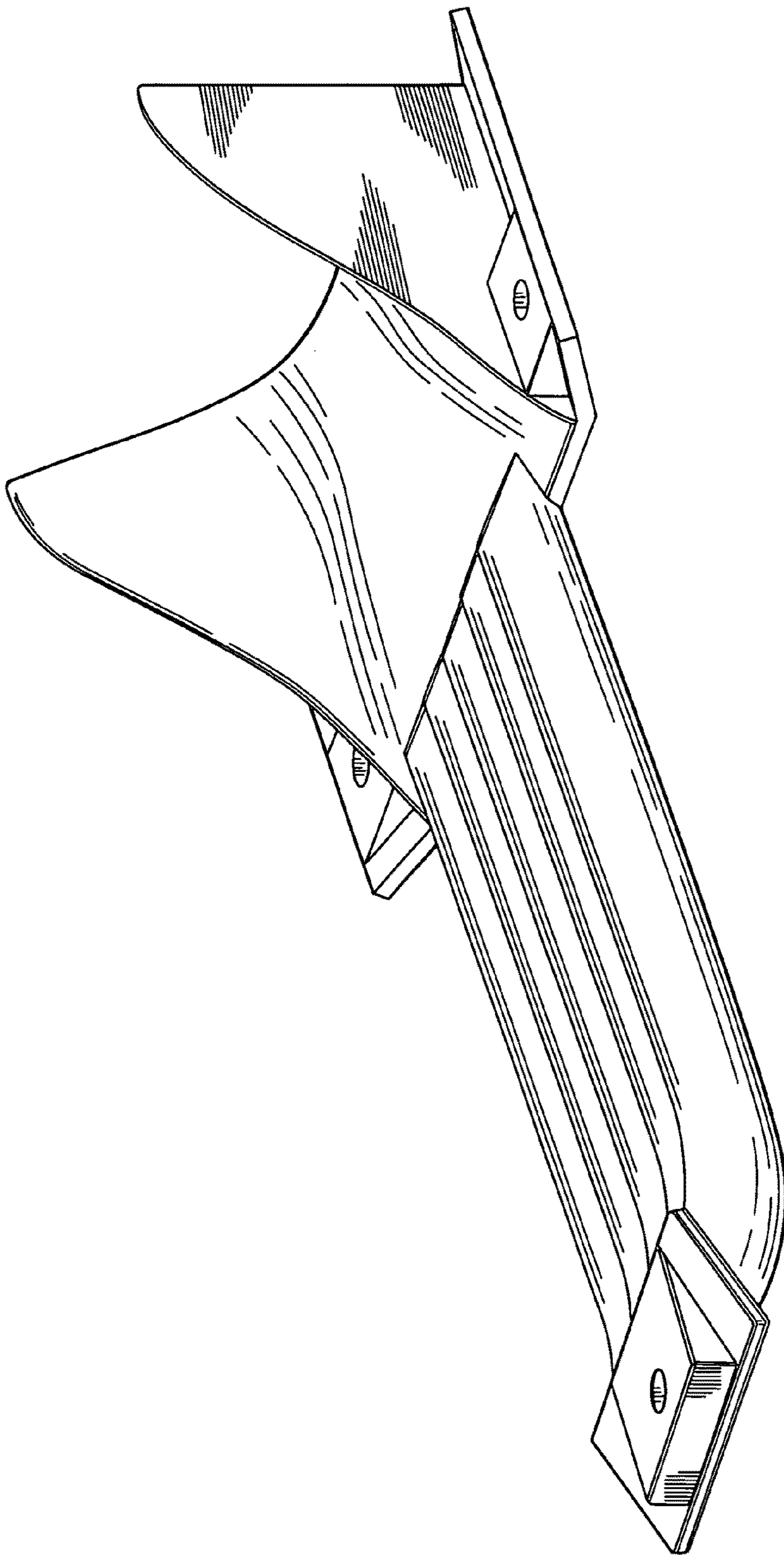

FIG. 1

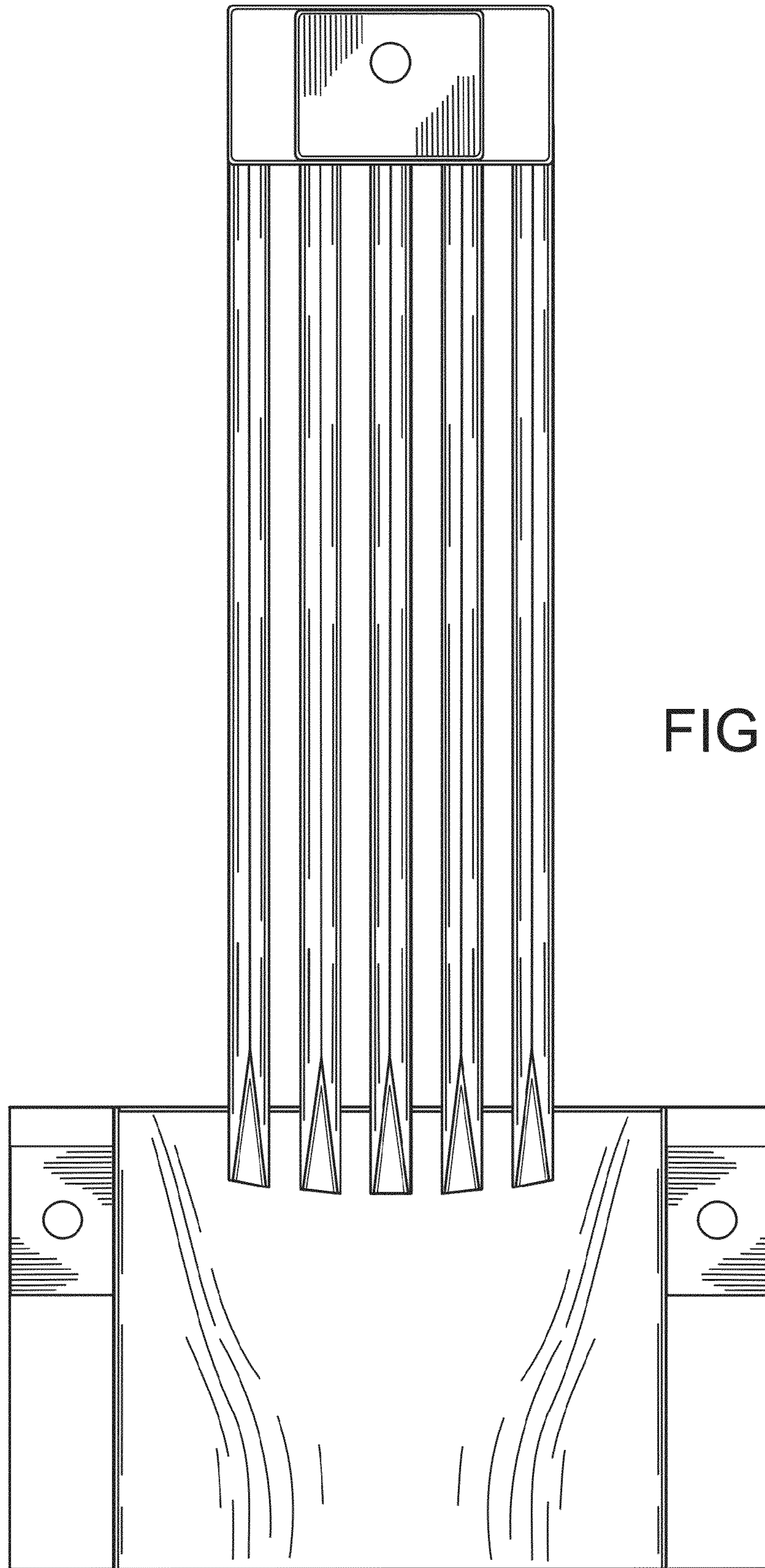

FIG. 2

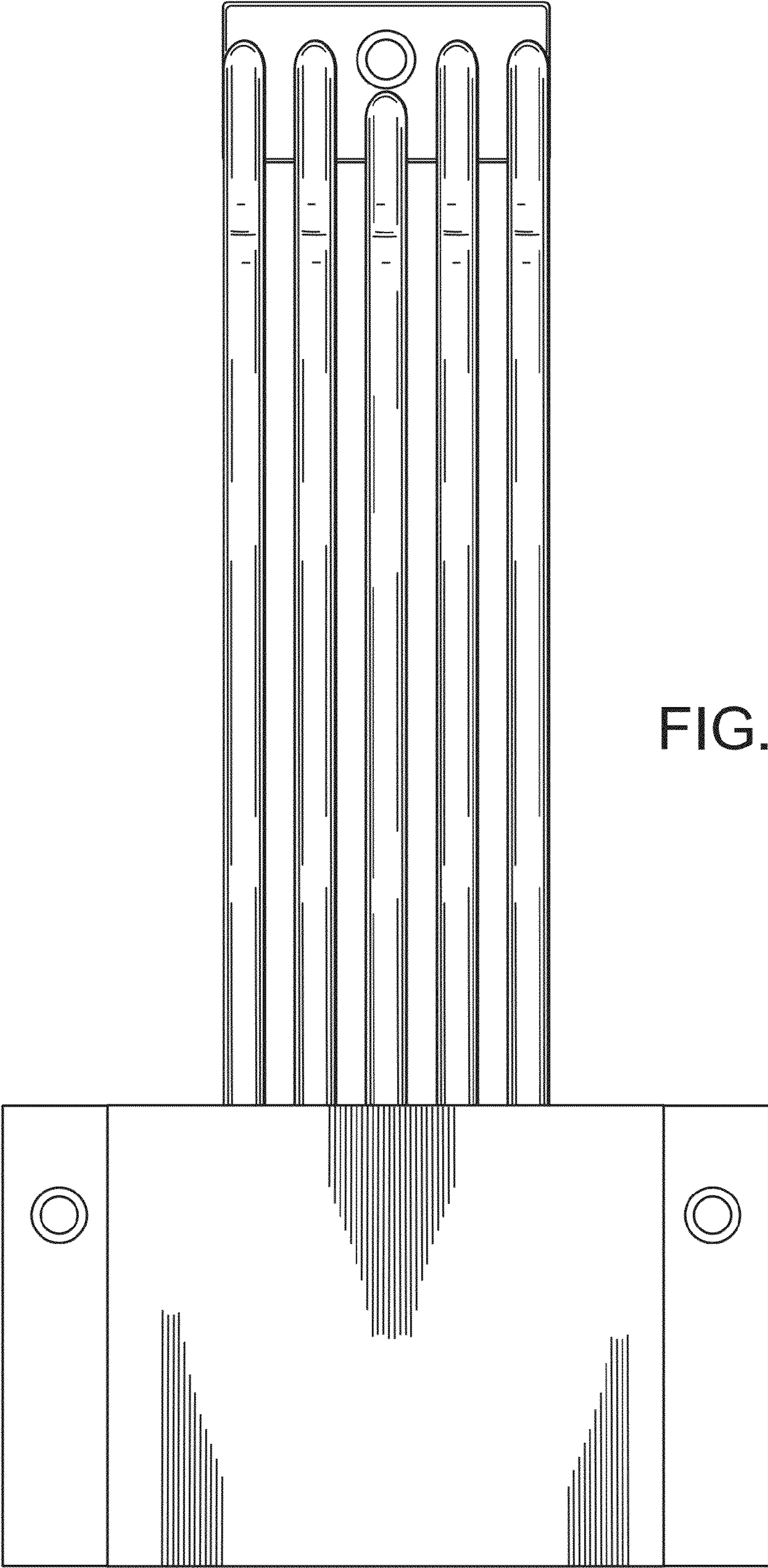

FIG. 3

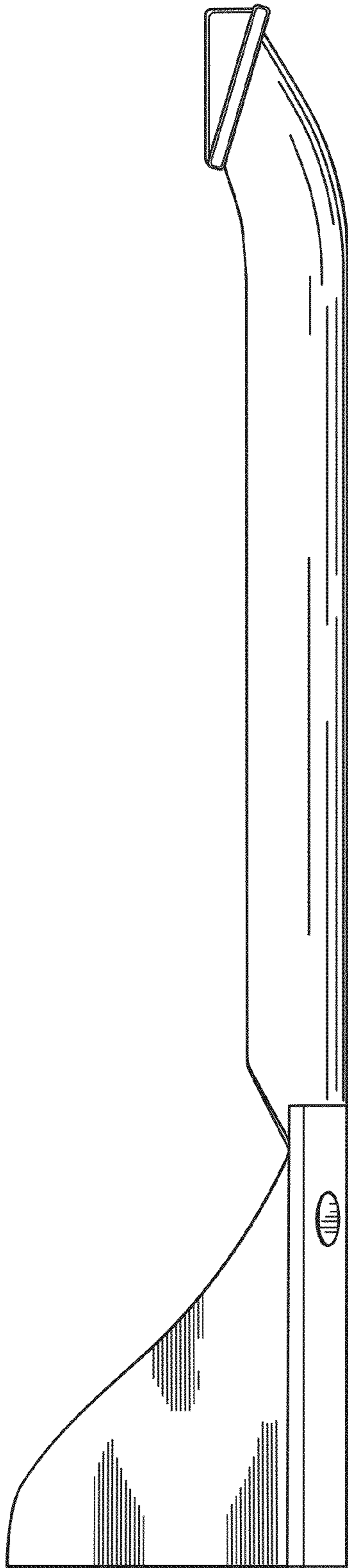

FIG. 4

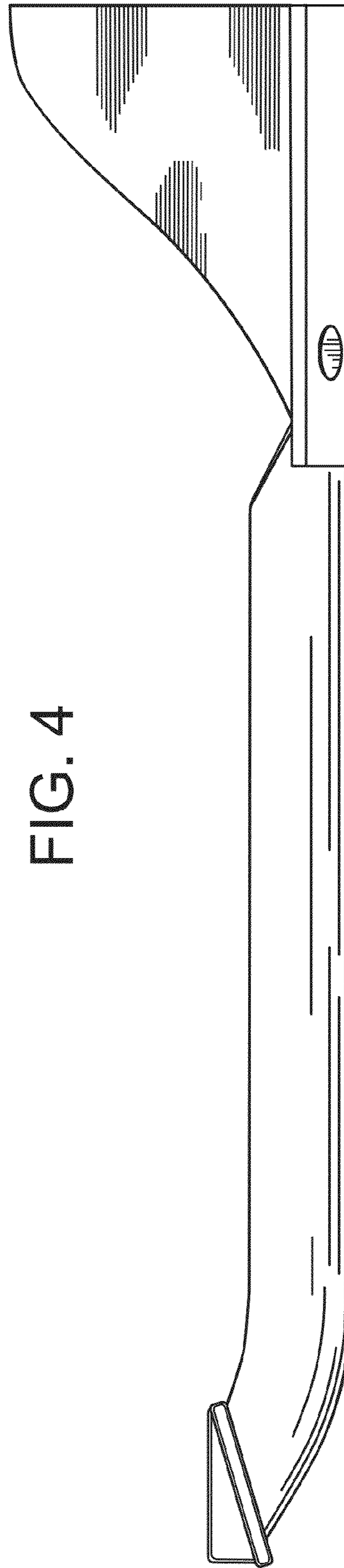

FIG. 5

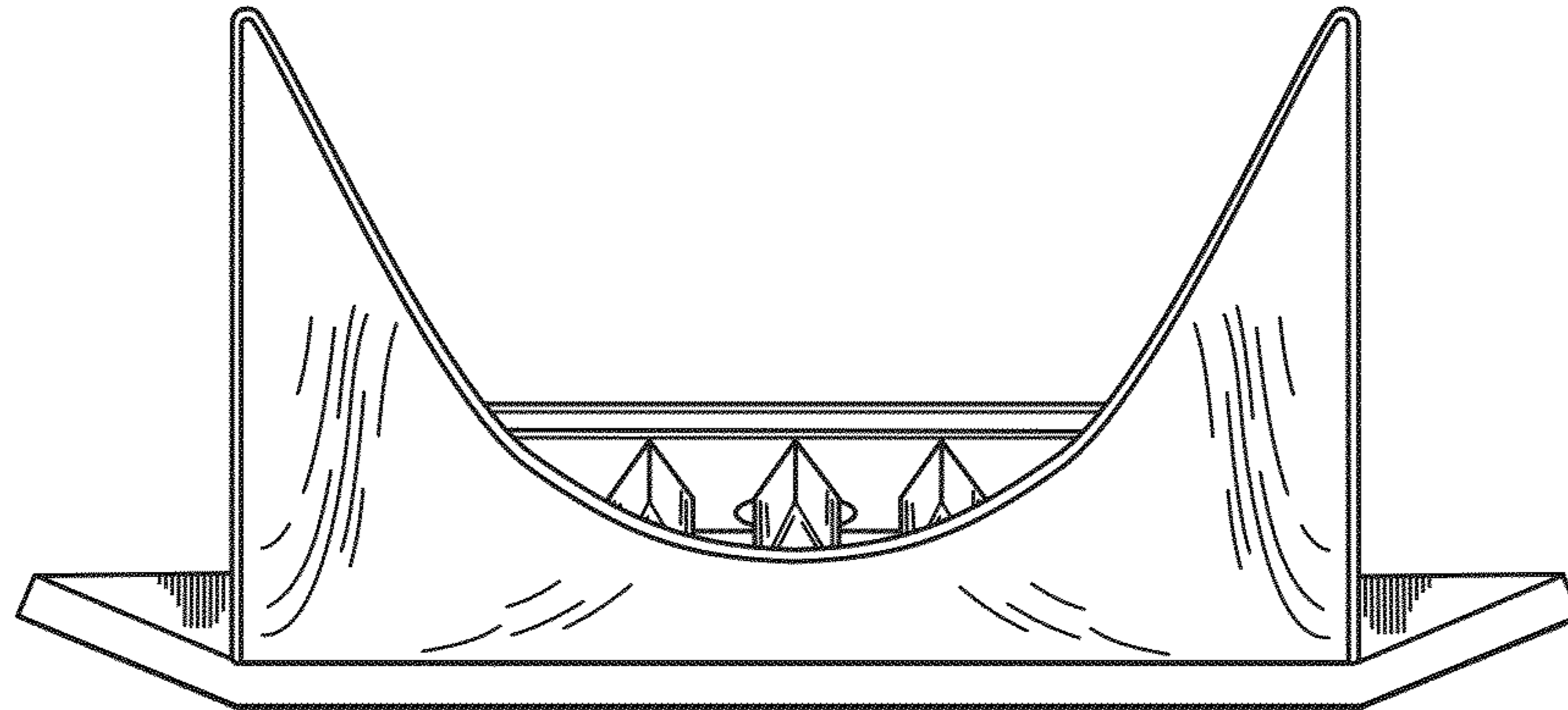

FIG. 6

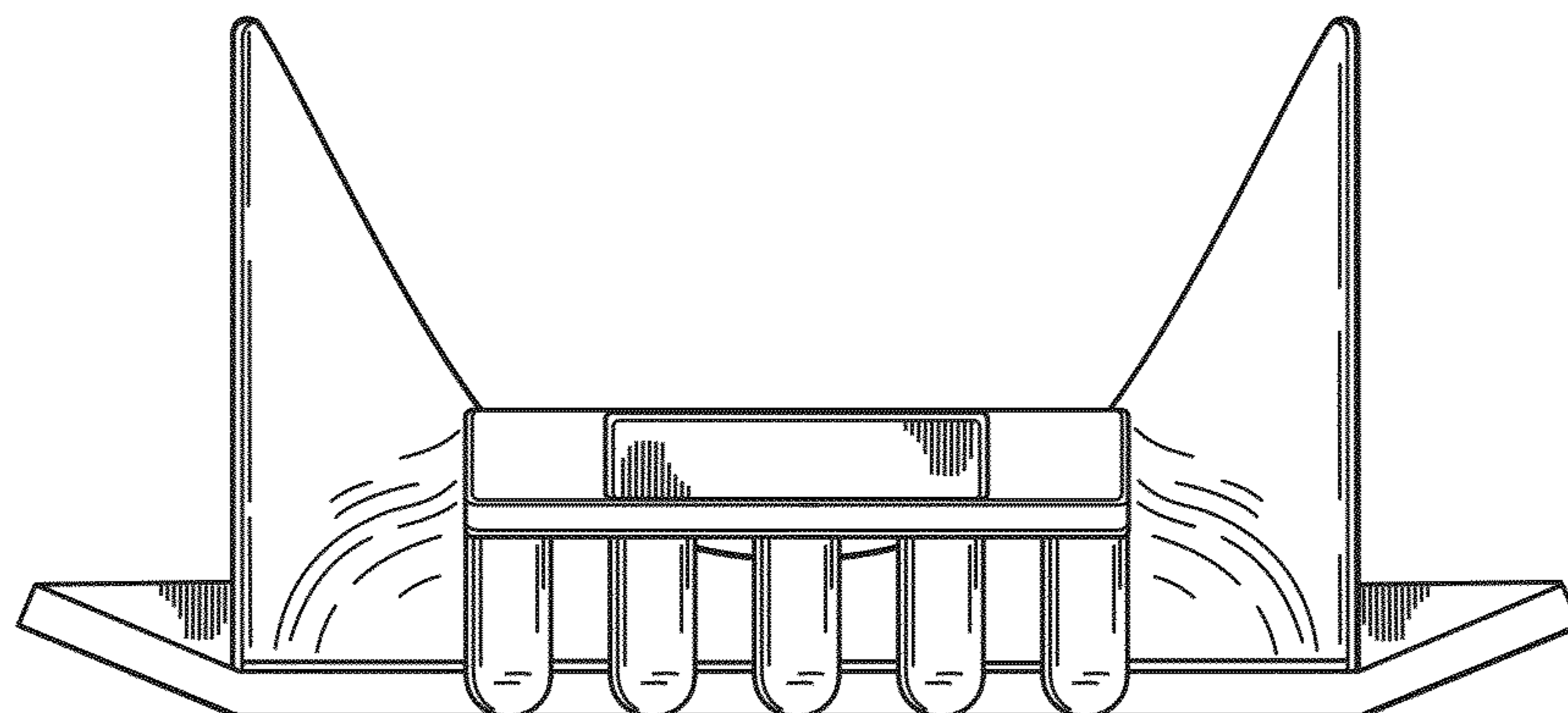

FIG. 7