



US00D743802S

(12) **United States Design Patent**
Leslie et al.

(10) **Patent No.:** **US D743,802 S**
(45) **Date of Patent:** **** Nov. 24, 2015**

(54) **BEVERAGE BOTTLE**

(71) Applicant: **Welch Foods Inc., A Cooperative**,
Concord, MA (US)

(72) Inventors: **Stuart M. Leslie**, Larchmont, NY (US);
Jason C. Billig, Mount Vernon, NY
(US); **Daniel T. Kim**, Washington
Township, NJ (US); **Karen Mitchell**,
Chelmsford, MA (US); **Stratos Dimas**,
Lexington, MA (US); **Sheldon Yourist**,
York, PA (US); **Raymond A. Pritchett**,
Jr., Manchester, PA (US)

(73) Assignee: **Welch Foods Inc., A Cooperative**,
Concord, MA (US)

(**) Term: **14 Years**

(21) Appl. No.: **29/461,865**

(22) Filed: **Jul. 29, 2013**

(51) **LOC (10) Cl.** **09-01**

(52) **U.S. Cl.**
USPC **D9/563; D9/565; D9/530; D9/538**

(58) **Field of Classification Search**
USPC D9/516, 519, 530, 535, 537-539,
D9/541-545, 550-554, 558-559, 565-7,
D9/563, 431, 435, 439-440, 444-447,
D9/449-450, 454, 522, 524, 526, 561,
D9/572-575, 649, 655, 682, 685, 688-693,
D9/723-724; D19/79-84, 93;
D23/211.1-211.2; D4/16; D28/7, 73,
D28/76-77, 83; D7/510, 511; D3/202
CPC A47J 41/02; A47J 41/0077; B65D 1/0215;
B65D 1/0223; B65D 23/102; B65D 23/106;
B29L 2031/463

See application file for complete search history.

(56) **References Cited**

U.S. PATENT DOCUMENTS

D217,230	S	*	4/1970	Kessig	D9/500
D233,828	S	*	12/1974	Leary	D9/541
D237,861	S	*	12/1975	Rossi	D9/520
D387,284	S	*	12/1997	Briggs	D9/538
D389,068	S	*	1/1998	Hooker	D9/537
D415,964	S	*	11/1999	Manderfield, Jr.	D9/530
D420,588	S	*	2/2000	Fitelson	D9/434
D422,915	S	*	4/2000	Hestehave	D9/500
D486,739	S	*	2/2004	Taylor	D9/530
D503,620	S	*	4/2005	Taylor	D9/518
D509,740	S	*	9/2005	Collins	D9/516
D509,741	S	*	9/2005	Collins	D9/516
D531,913	S	*	11/2006	Heisner	D9/560
D539,158	S	*	3/2007	Miller	D9/541
D573,883	S	*	7/2008	Zboch	D9/516
D598,774	S	*	8/2009	Schlies	D9/541
D621,264	S	*	8/2010	Williams	D9/516
D659,544	S	*	5/2012	Labadie	D9/542
D664,857	S	*	8/2012	Finlay	D9/560
D676,329	S	*	2/2013	Yourist	D9/541
D680,003	S	*	4/2013	Desjardins	D9/560
D709,769	S	*	7/2014	Yourist	D9/516

FOREIGN PATENT DOCUMENTS

CN	300714894	*	12/2007
GB	2094628	*	4/2001
JP	D1212794	*	7/2004
RU	00058460	*	1/2006
WO	WO D054644-001	*	2/2001

OTHER PUBLICATIONS

Welch's New Farmer's Pick Spreads & Juices | She Scribes, article date May 7, 2014, online, <http://www.shescribes.com/2014/05/welchs-new-farmers-pick-spreads-juices.html>, site visited Sep. 16, 2015.*
Citrus juice producer now shipping all products in 100% PCR boxes | Greener Package, Feb. 4, 2011, online, http://www.greenerpackage.com/recycled_content/citrus_juice_producer_now_shipping_all_products_100_pcr_boxes, [site visited Sep. 16, 2015 6:30:32 PM].*
Amazon.com : Juicy Juice Grape Juice, 64-Ounce Pet Bottles, review date 2013, online, <http://www.amazon.com/Juicy-Juice-Grape-64-Ounce-Bottles/dp/B004B8SC7A>, [site visited Sep. 16, 2015 6:34:18 PM].*
Retrieved Jun. 14, 2013 from the Internet URL <http://www.oceanspray.com/Products/Juices/Cranberry/White-Cranberry.aspx>.

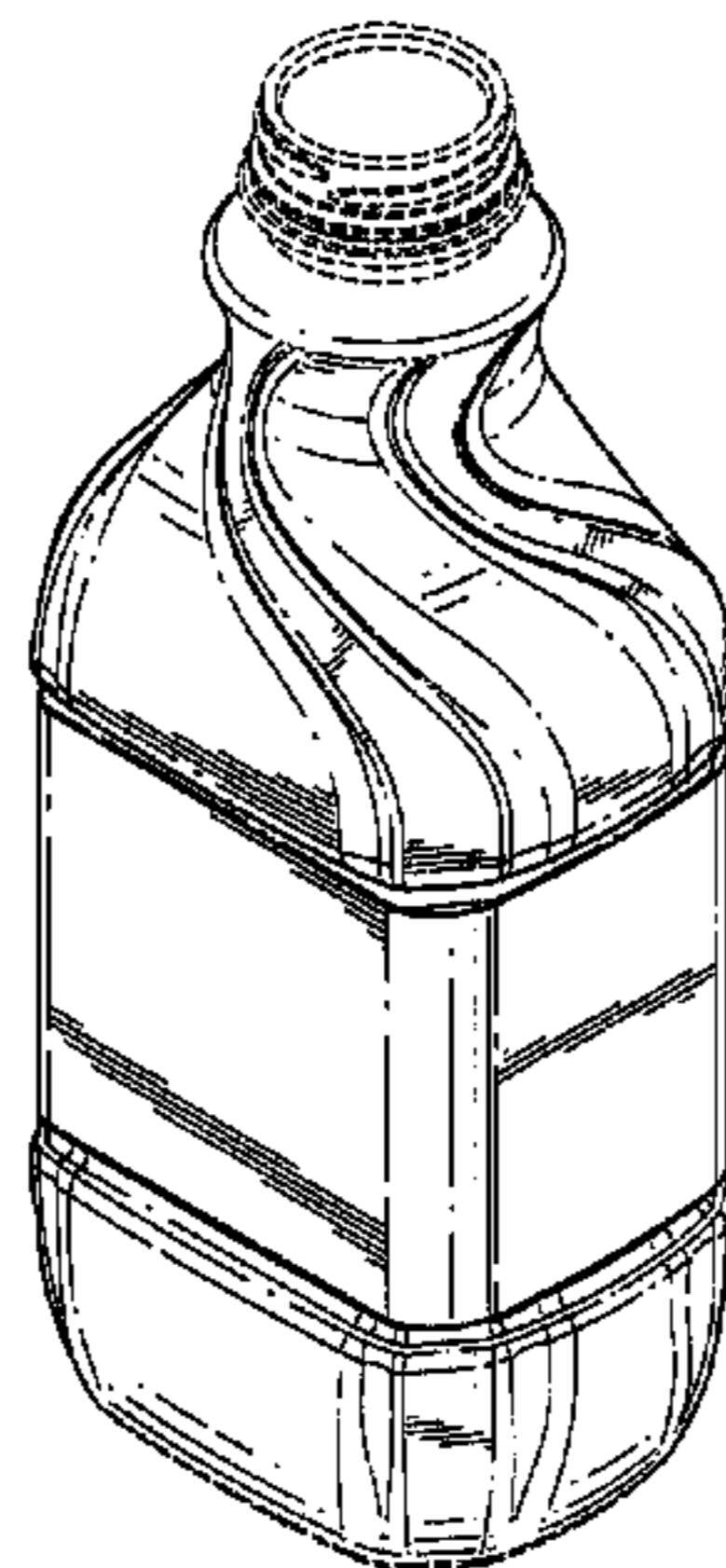
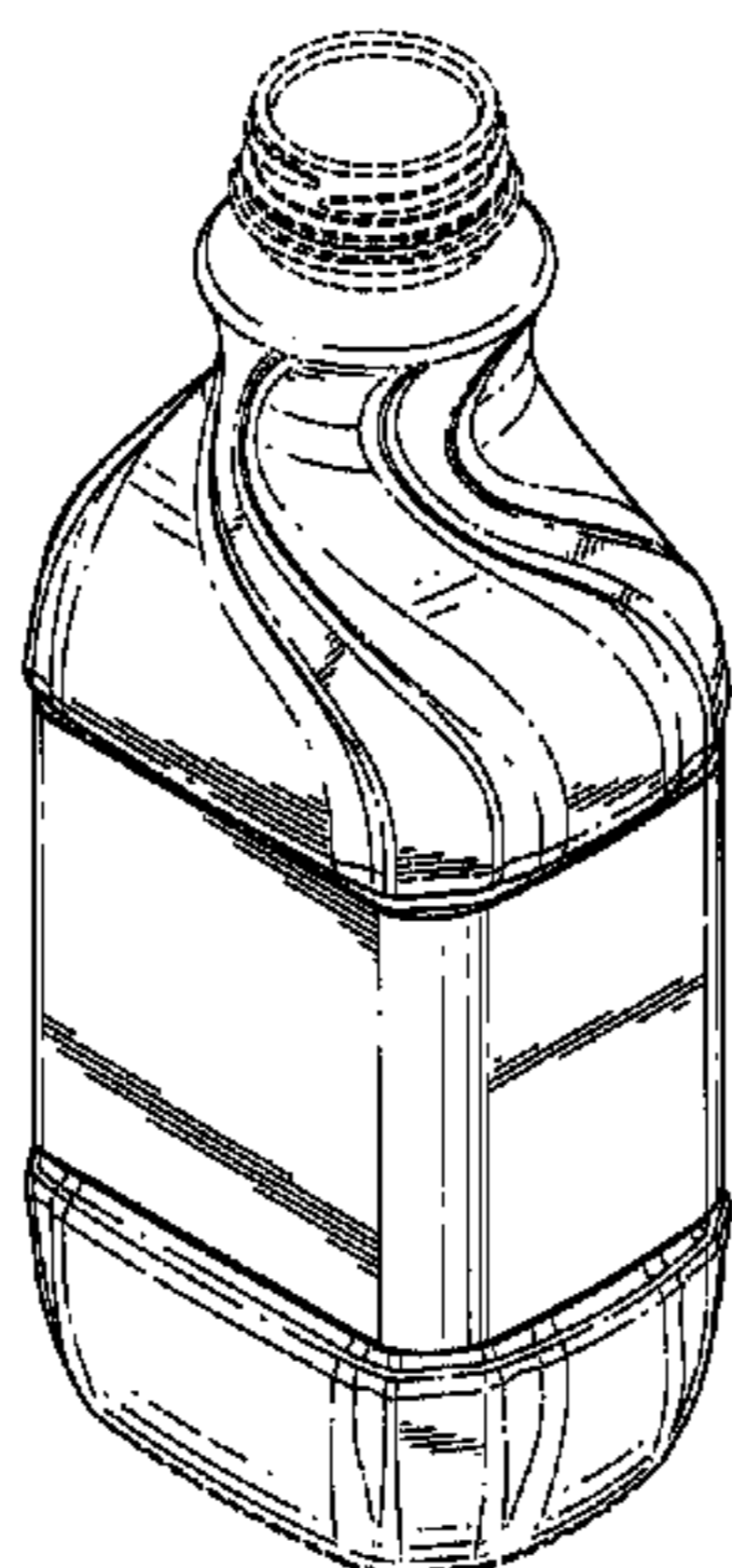

Retrieved Jun. 6, 2013 from the Internet URL <http://www.welchs.com/products/100-percent-juices>.

* cited by examiner

Primary Examiner — John Windmuller

Assistant Examiner — John R Yeh

(74) *Attorney, Agent, or Firm* — Hamilton, Brook, Smith & Reynolds, P.C.

(57) **CLAIM**

The ornamental design for a beverage bottle, as shown and described.

DESCRIPTION

FIG. 1 is a front perspective view of an embodiment of a beverage bottle in the present invention.

FIG. 2 is a bottom perspective view thereof.

FIG. 3 is a front view thereof.

FIG. 4 is a rear view thereof.

FIG. 5 is a top view thereof.

FIG. 6 is a bottom view thereof.

FIG. 7 is a left side view thereof.

FIG. 8 is a right side view thereof.

FIG. 9 is a front perspective view of another embodiment of a beverage bottle in the present invention.

FIG. 10 is a bottom perspective view thereof.

FIG. 11 is a front view thereof.

FIG. 12 is a rear view thereof.

FIG. 13 is a top view thereof.

FIG. 14 is a bottom view thereof.

FIG. 15 is a left side view thereof.

FIG. 16 is a right side view thereof.

FIG. 17 is a front perspective view of yet another embodiment of a beverage bottle in the present invention.

FIG. 18 is a bottom perspective view thereof.

FIG. 19 is a front view thereof.

FIG. 20 is a rear view thereof.

FIG. 21 is a top view thereof.

FIG. 22 is a bottom view thereof.

FIG. 23 is a left side view thereof.

FIG. 24 is a right side view thereof.

FIG. 25 is a front perspective view of still another embodiment of a beverage bottle in the present invention.

FIG. 26 is a bottom perspective view thereof.

FIG. 27 is a front view thereof.

FIG. 28 is a rear view thereof.

FIG. 29 is a top view thereof.

FIG. 30 is a bottom view thereof.

FIG. 31 is a left side view thereof; and,

FIG. 32 is a right side view thereof.

The broken lines in the drawings are for illustrative purposes only, and form no part of the claimed design.

The beverage bottle in the present invention is a liquid container that can contain beverage liquids.

1 Claim, 28 Drawing Sheets

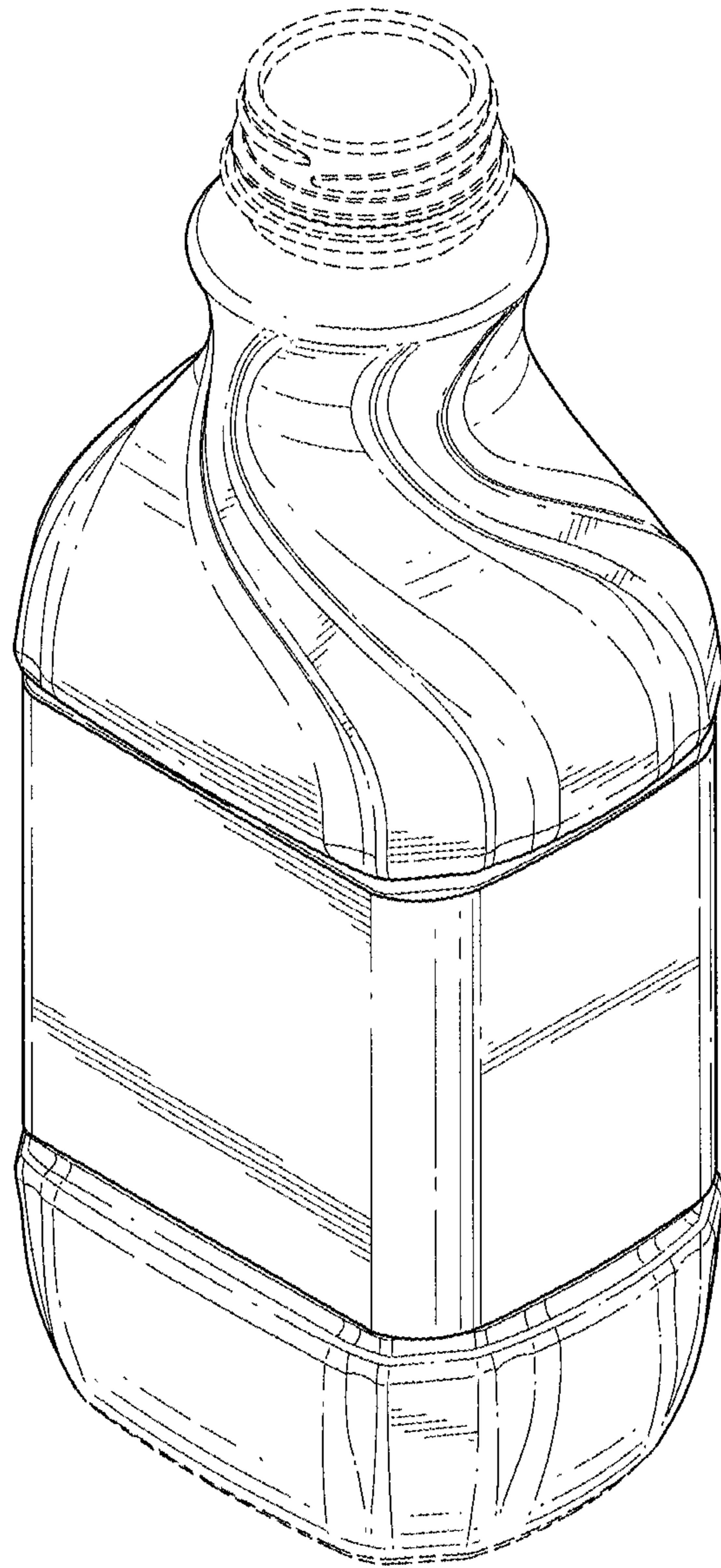

FIG. 1

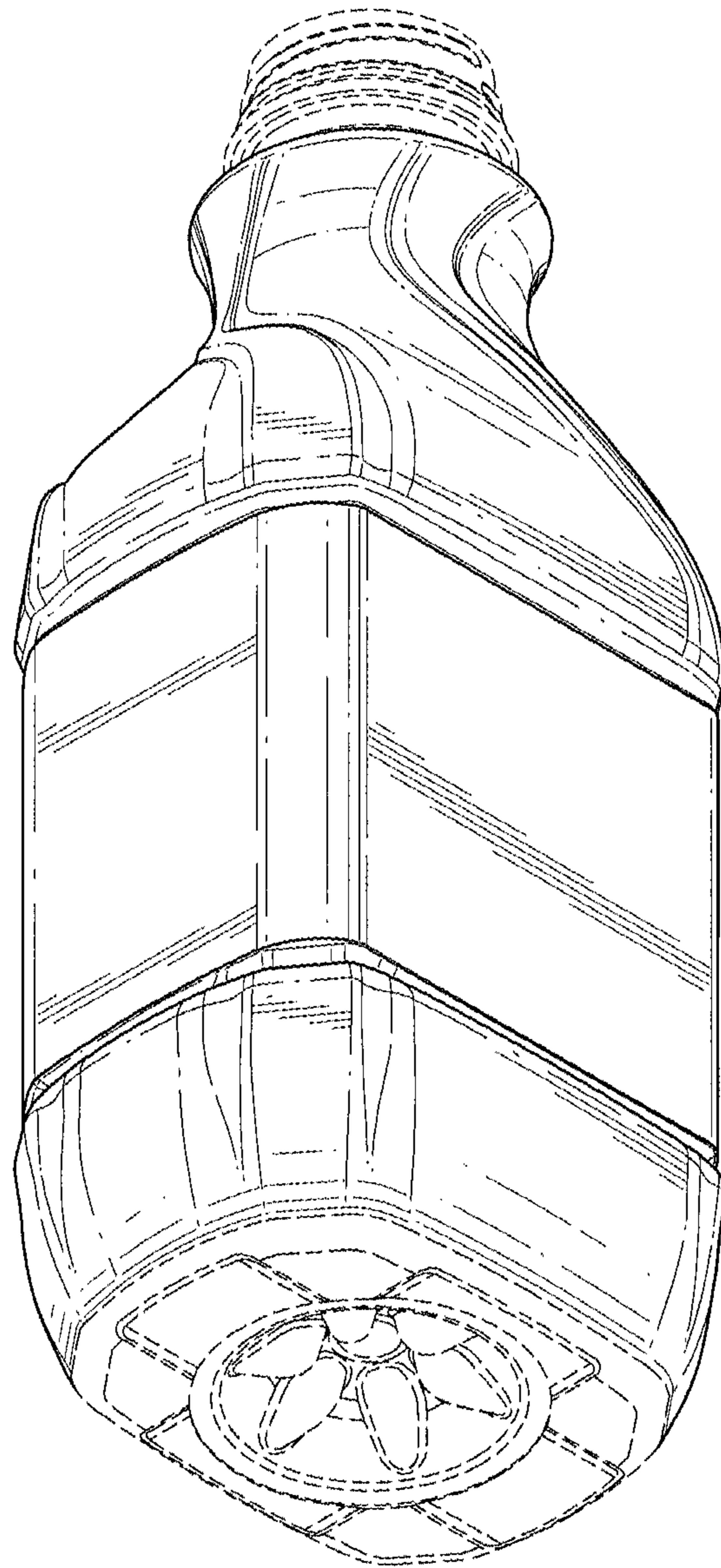

FIG. 2

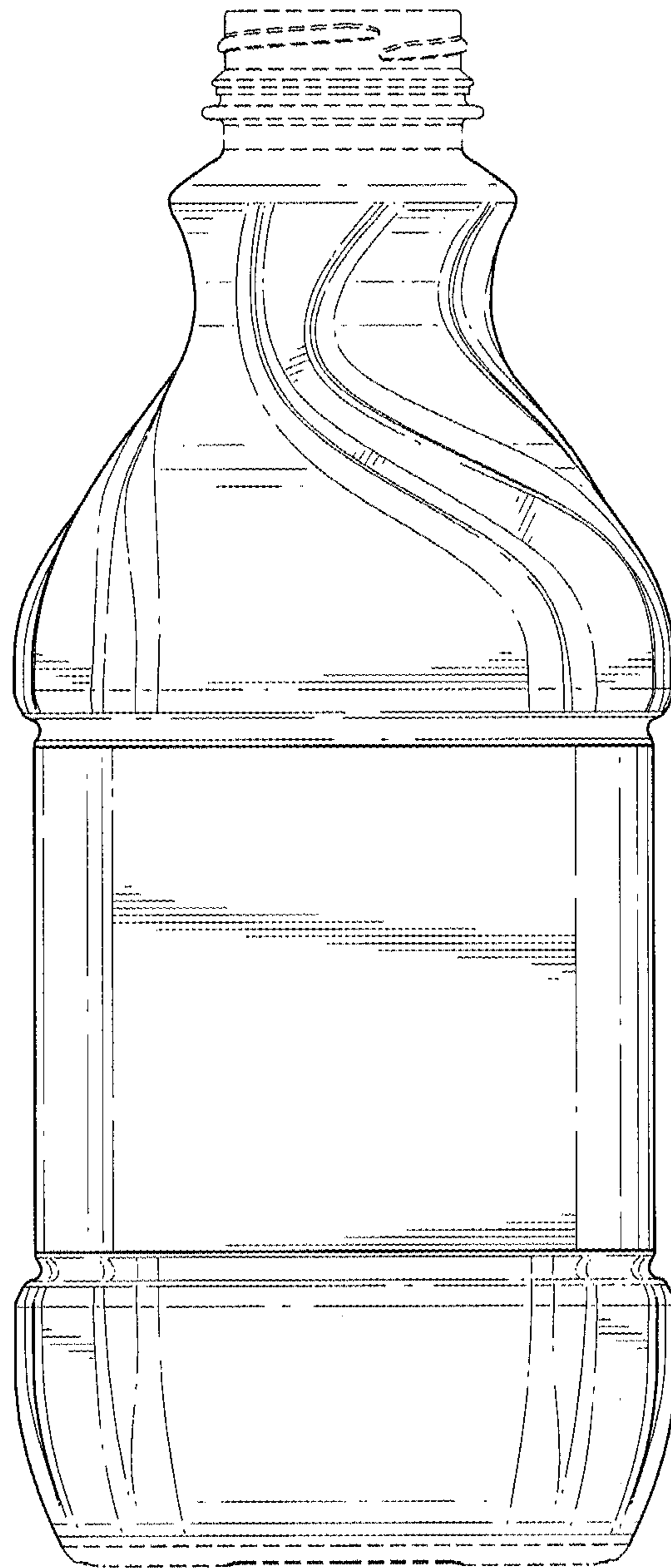

FIG. 3

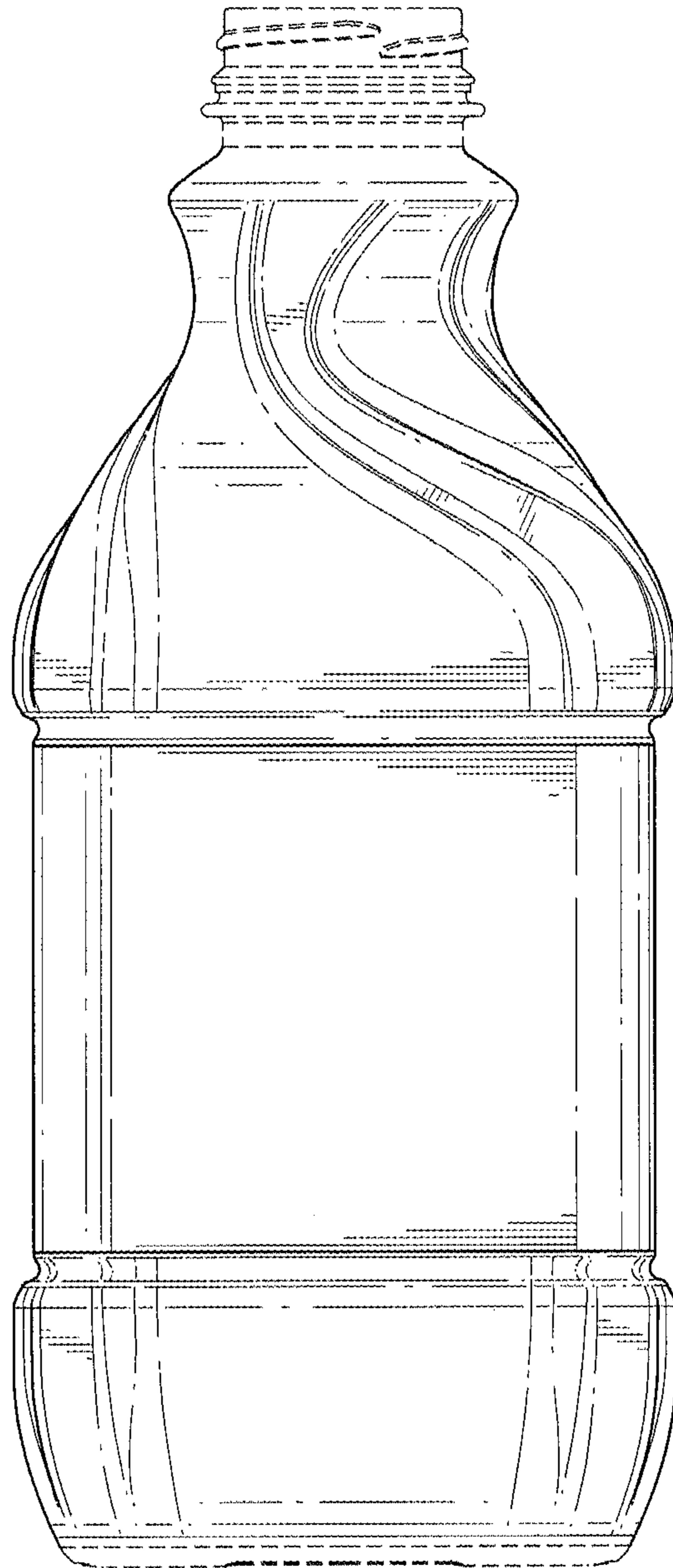

FIG. 4

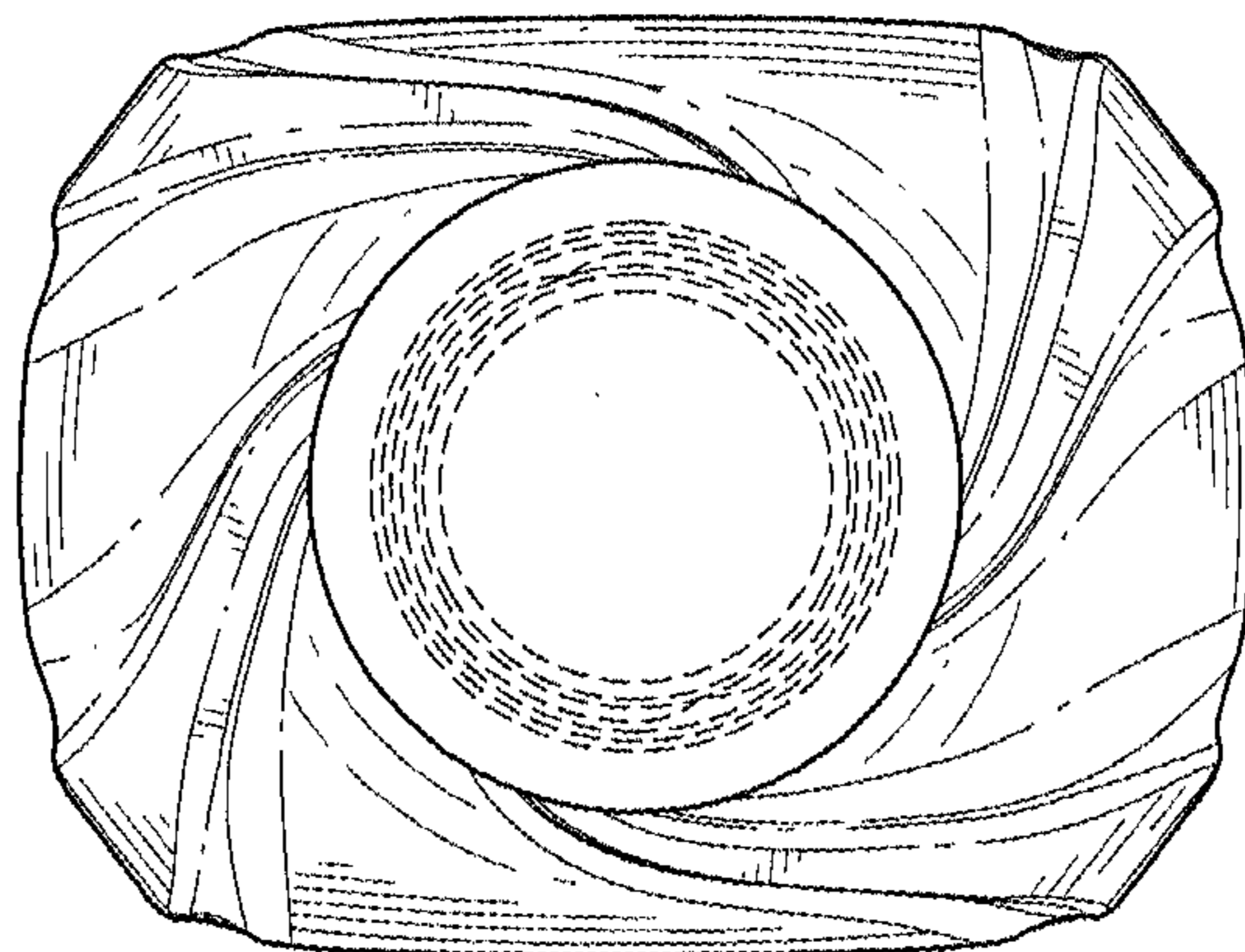

FIG. 5

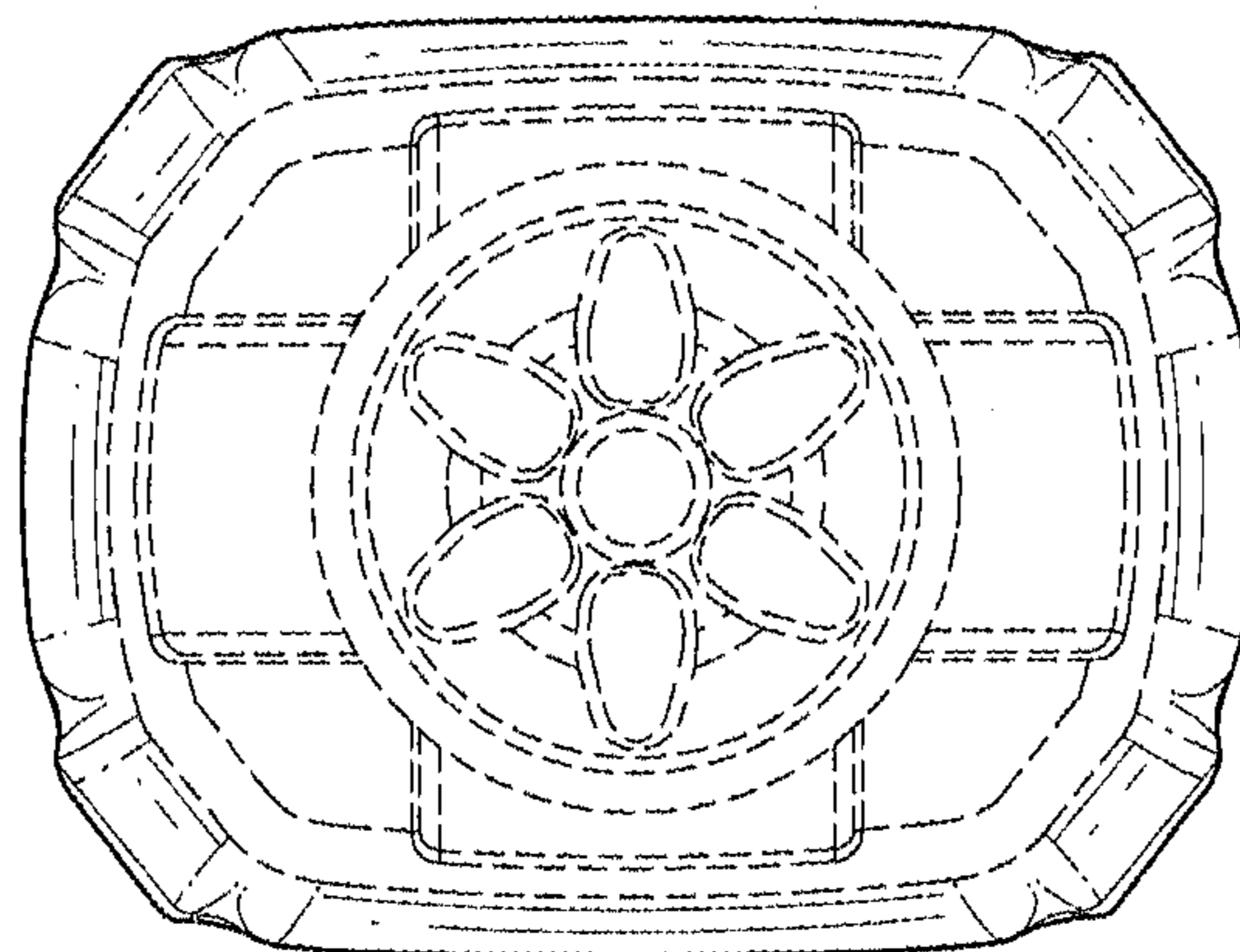

FIG. 6

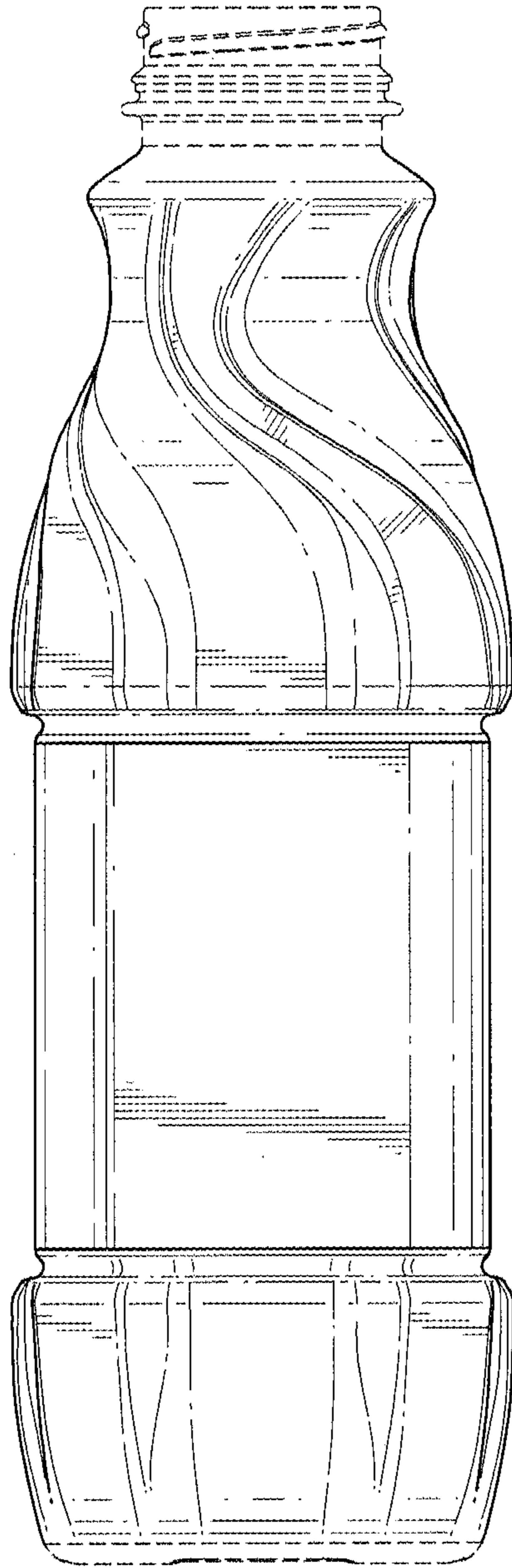

FIG. 7

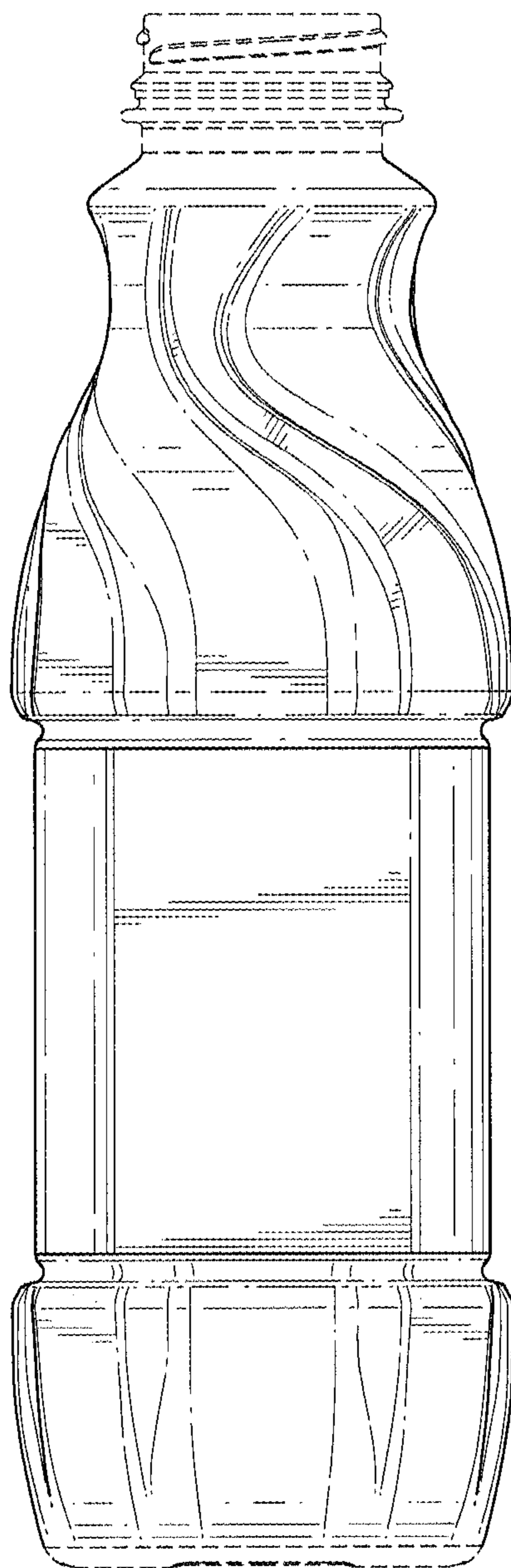

FIG. 8

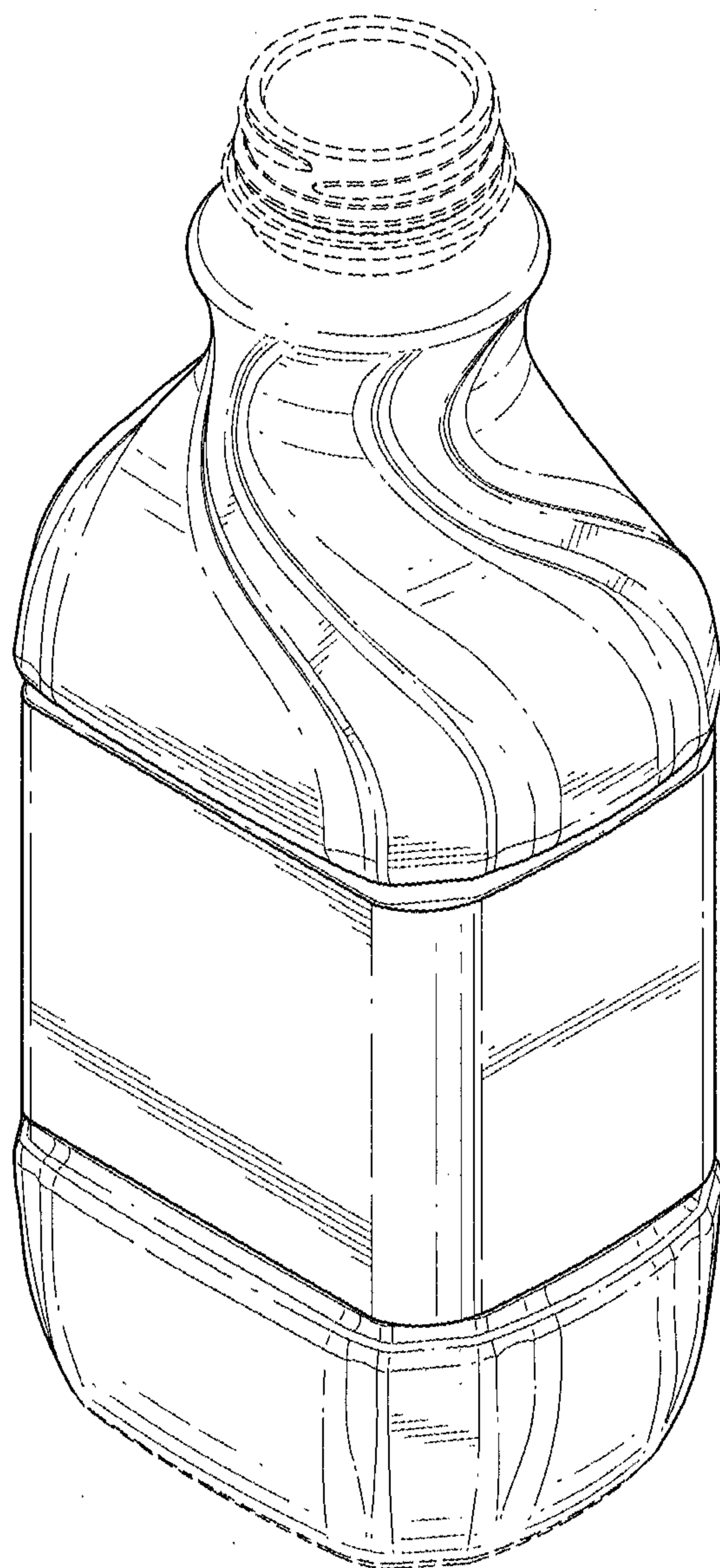

FIG. 9

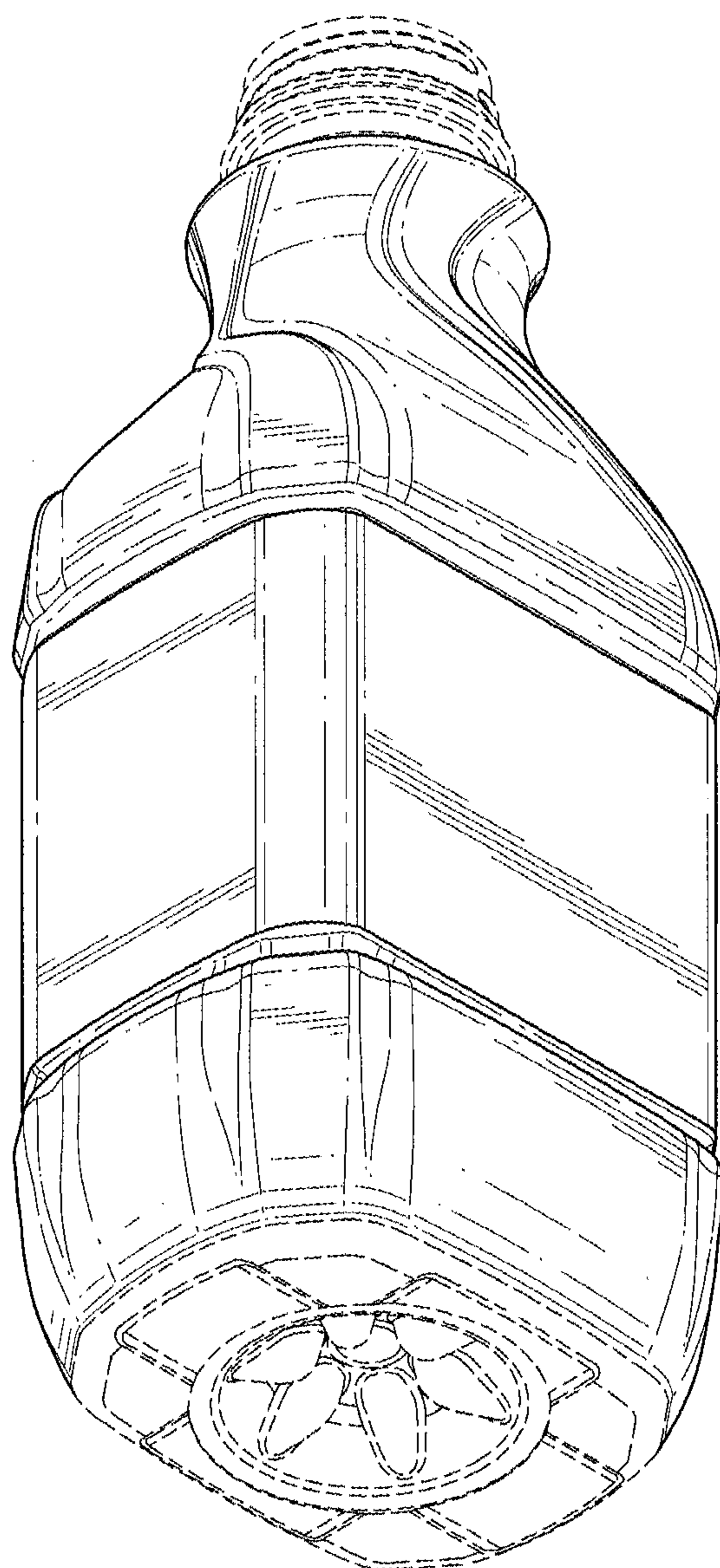

FIG. 10

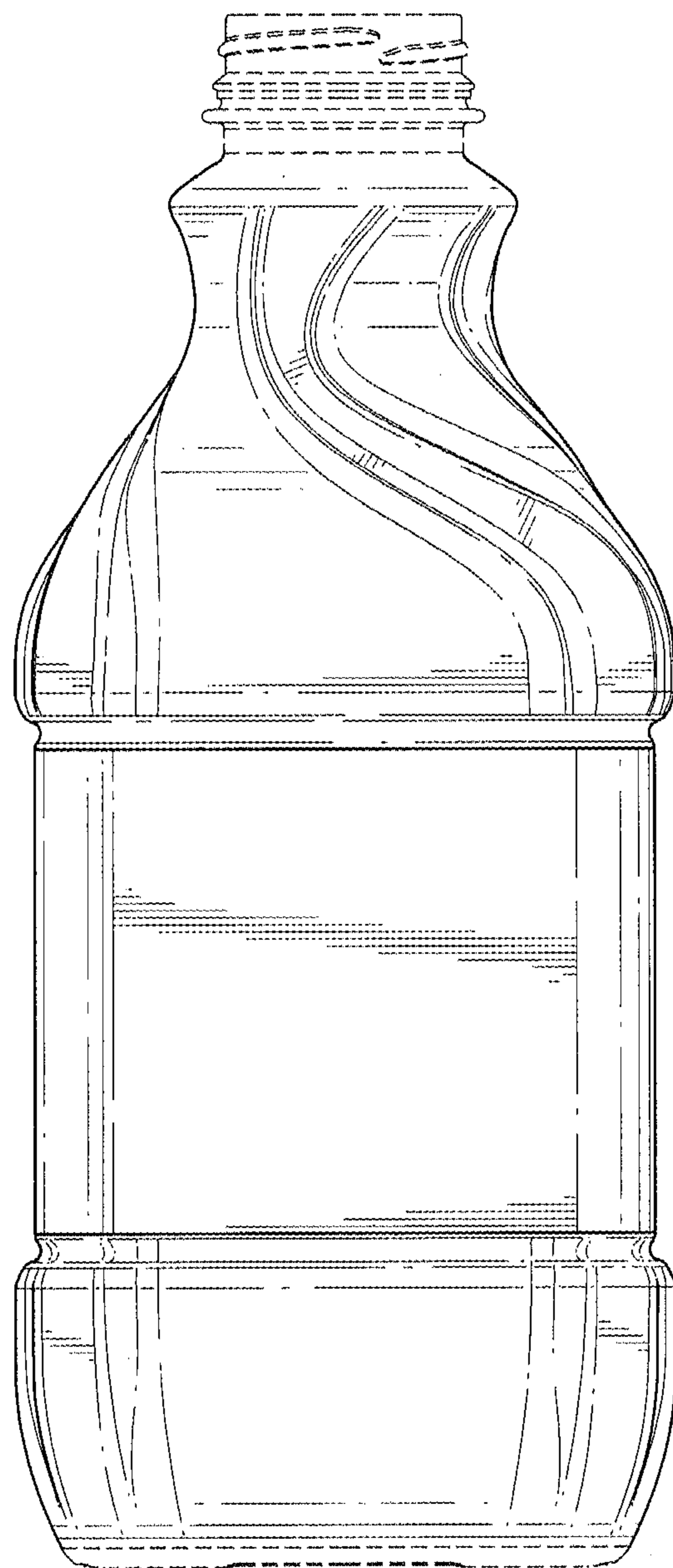

FIG. 11

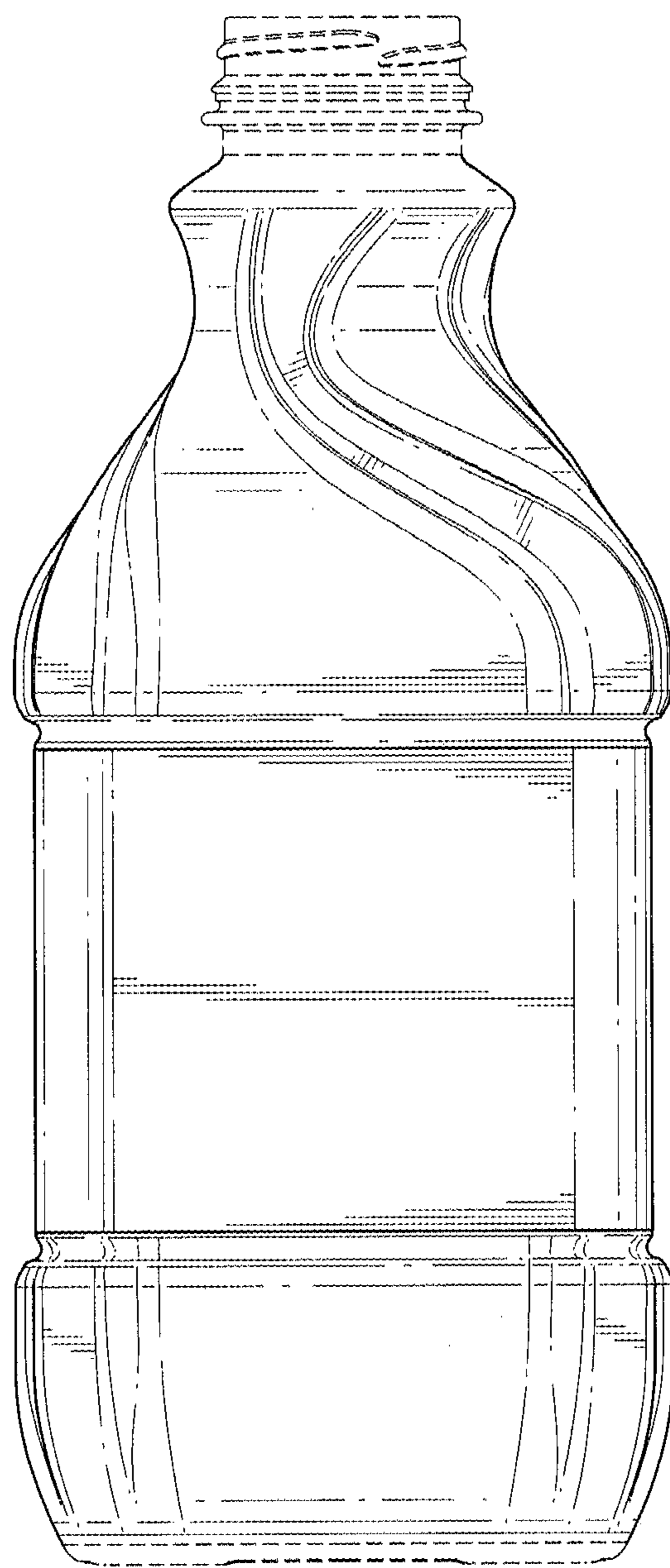

FIG. 12

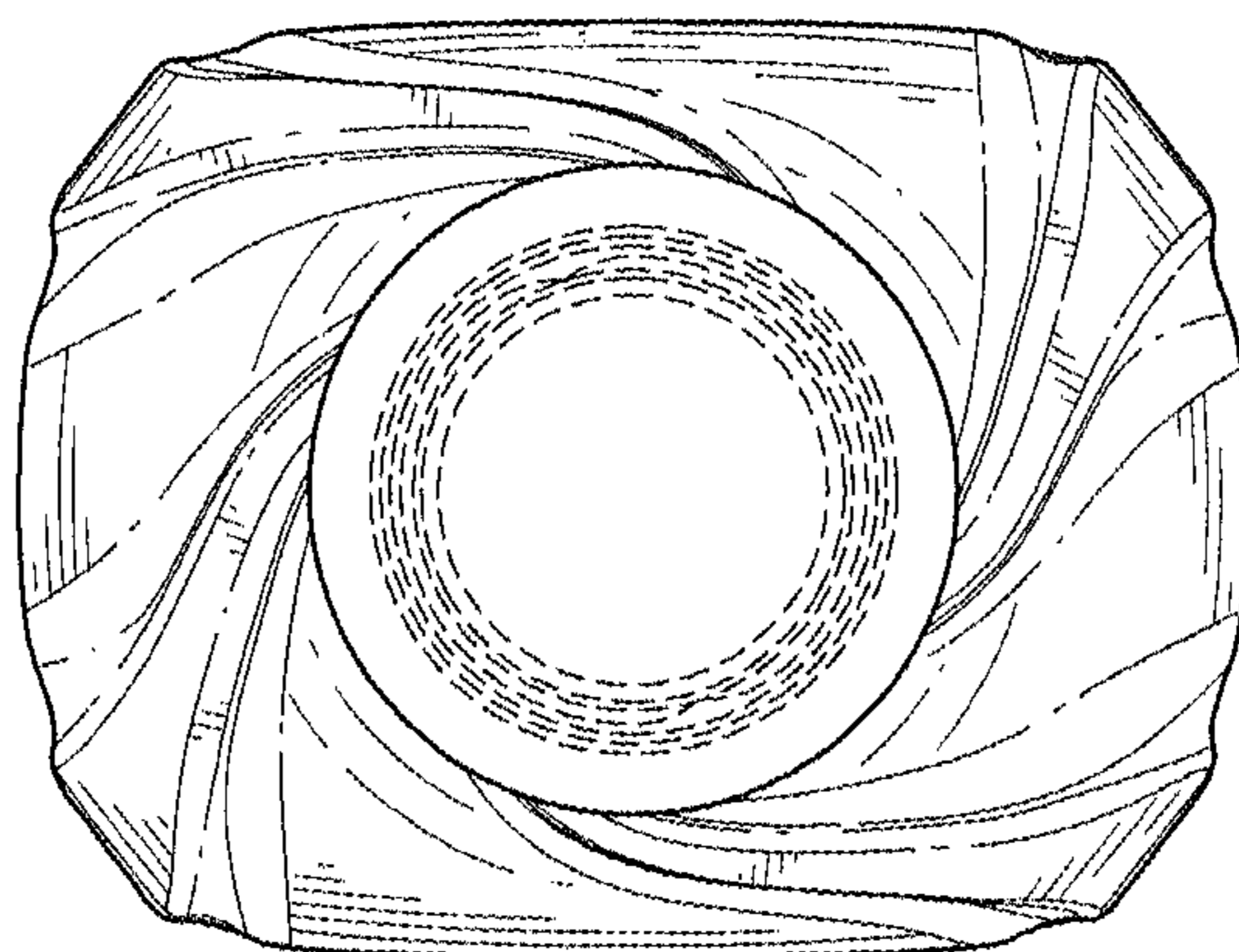

FIG. 13

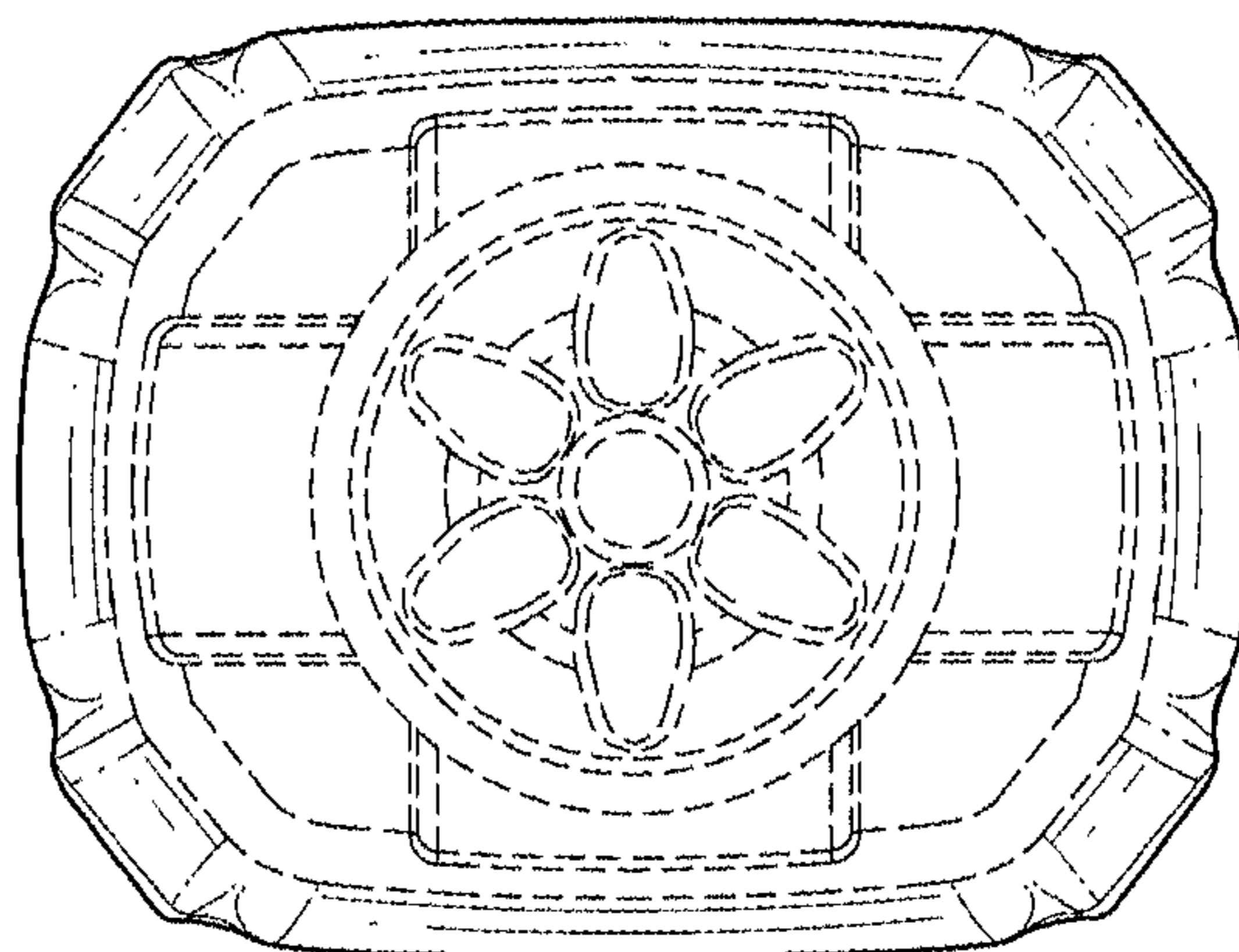

FIG. 14

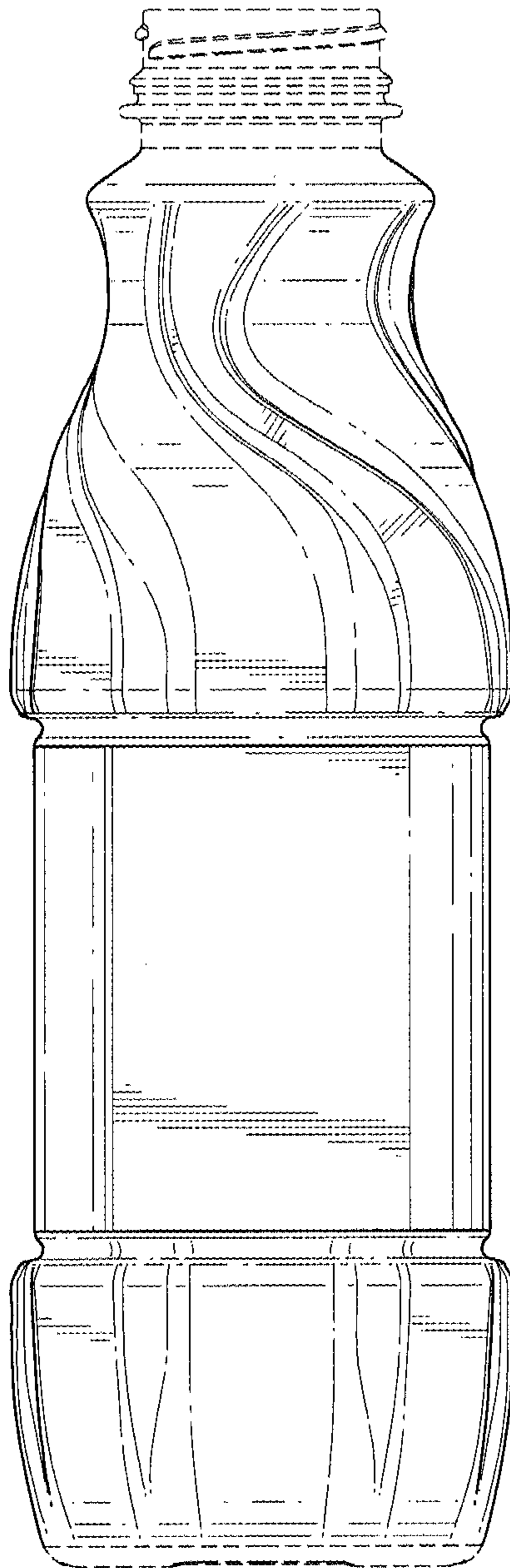

FIG. 15

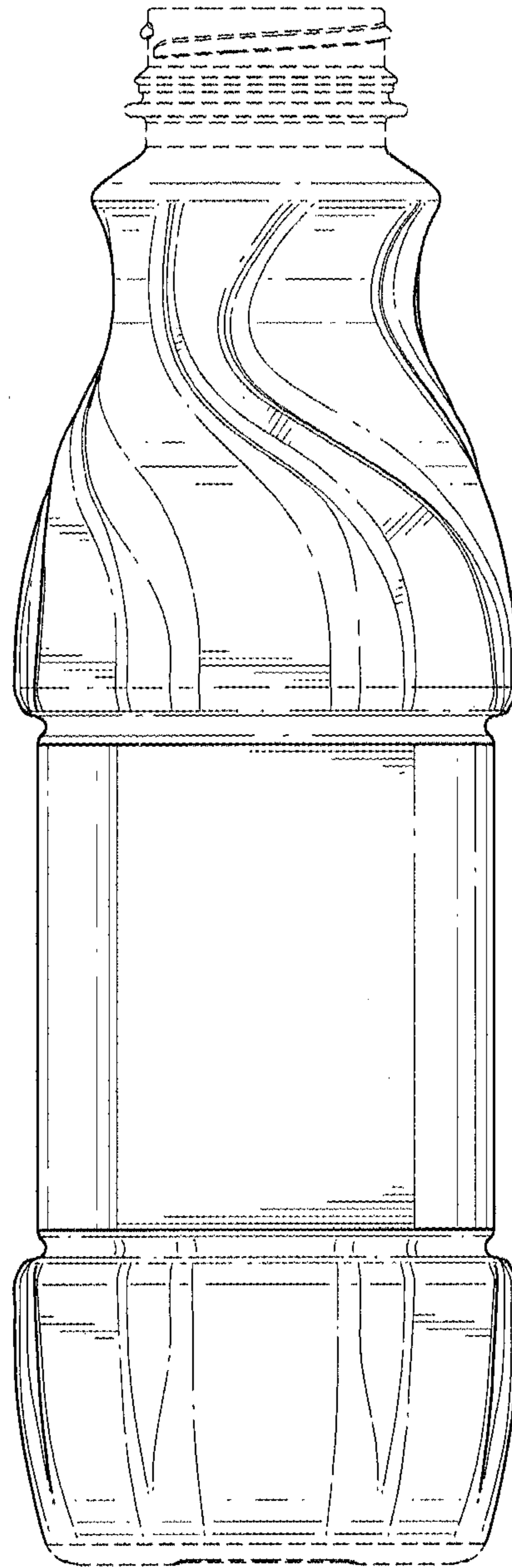

FIG. 16

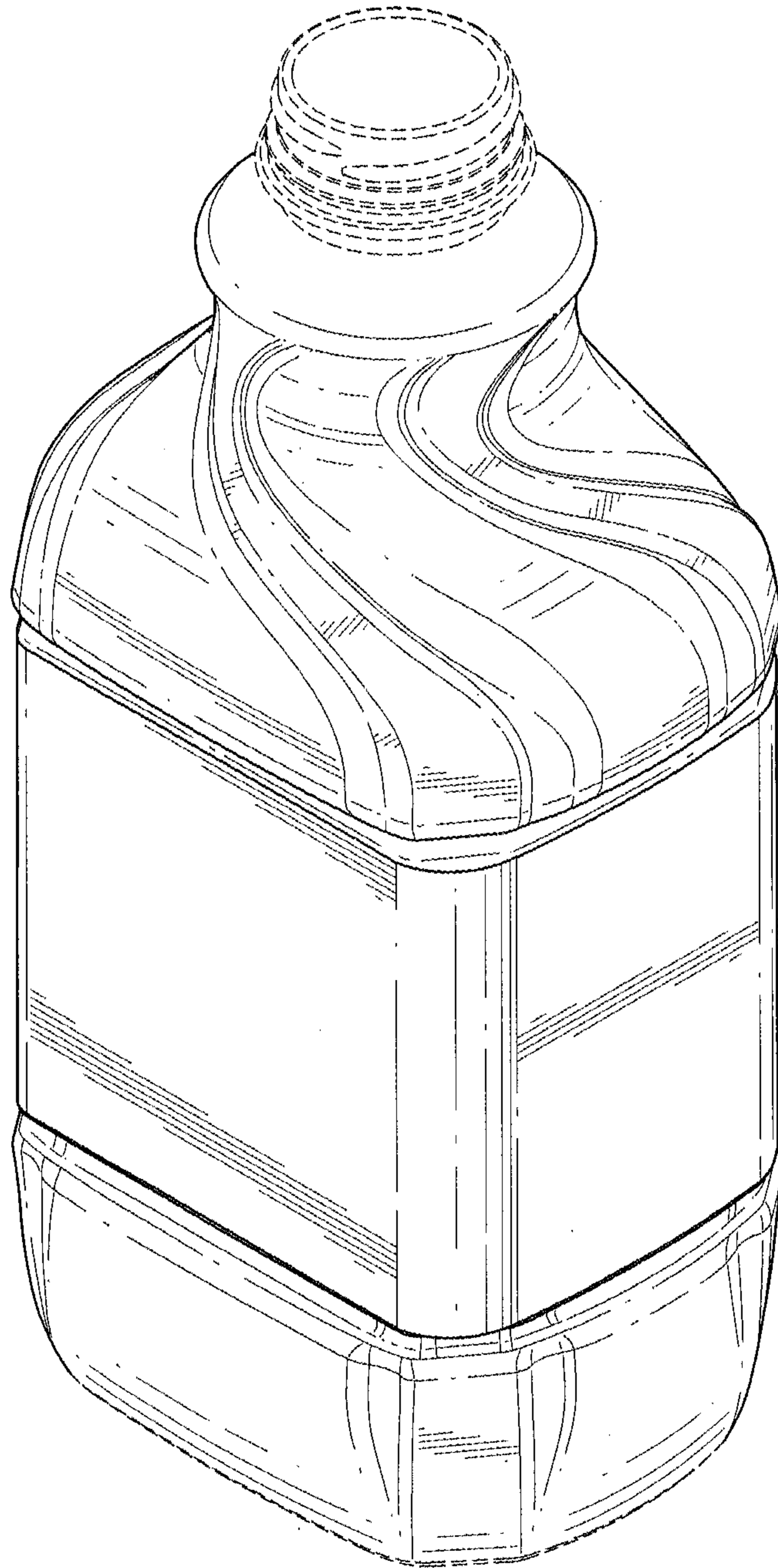

FIG. 17

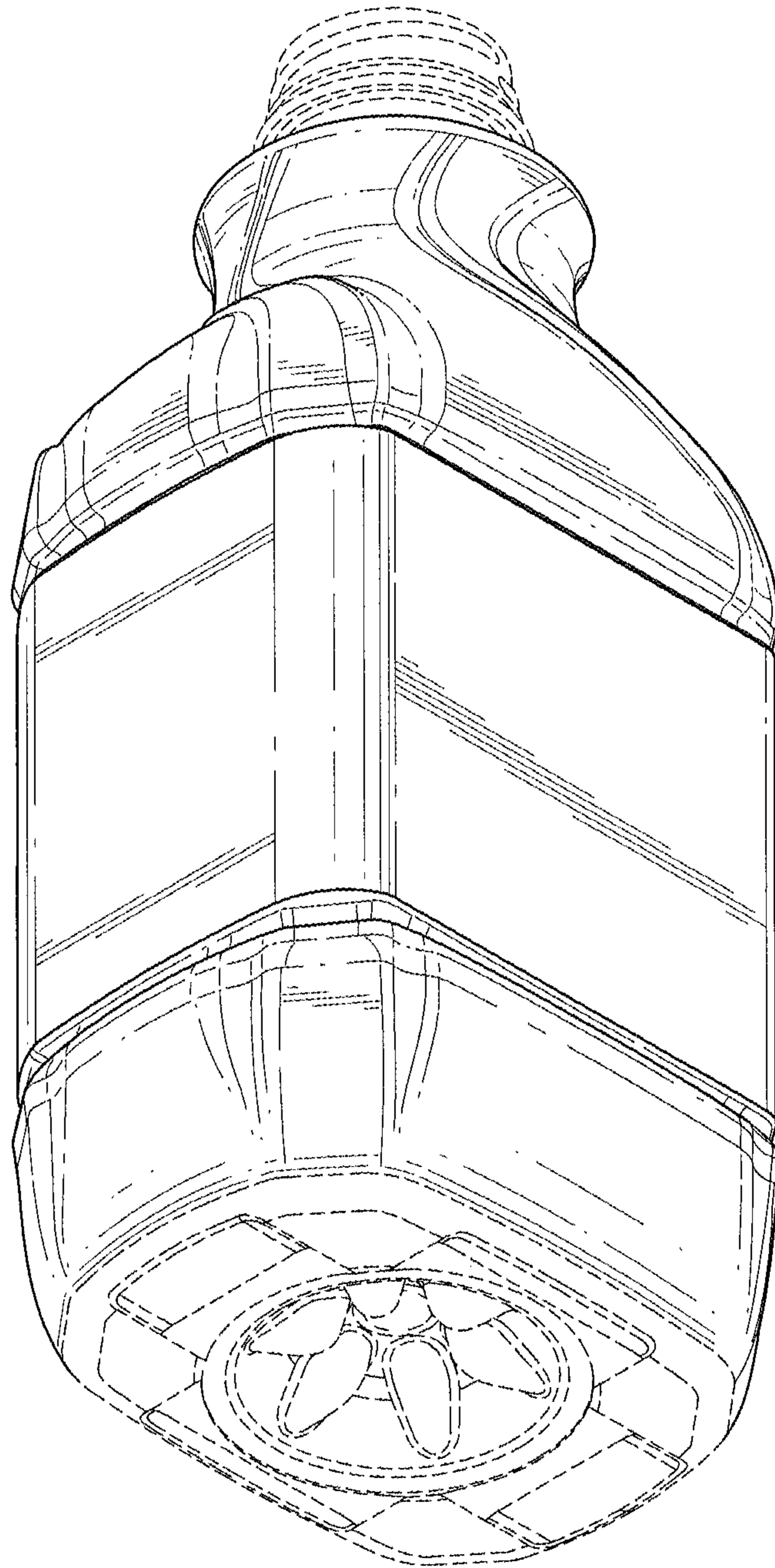

FIG. 18

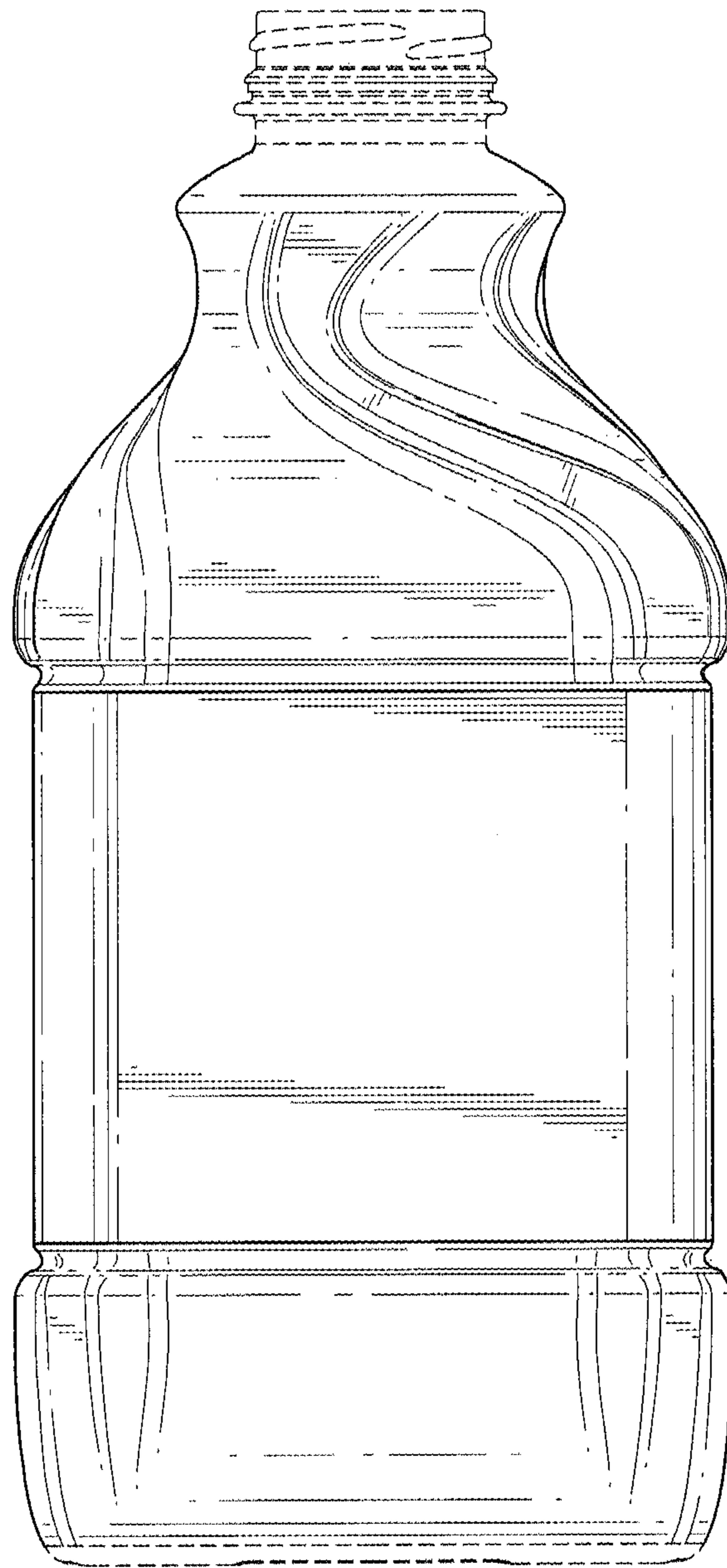

FIG. 19

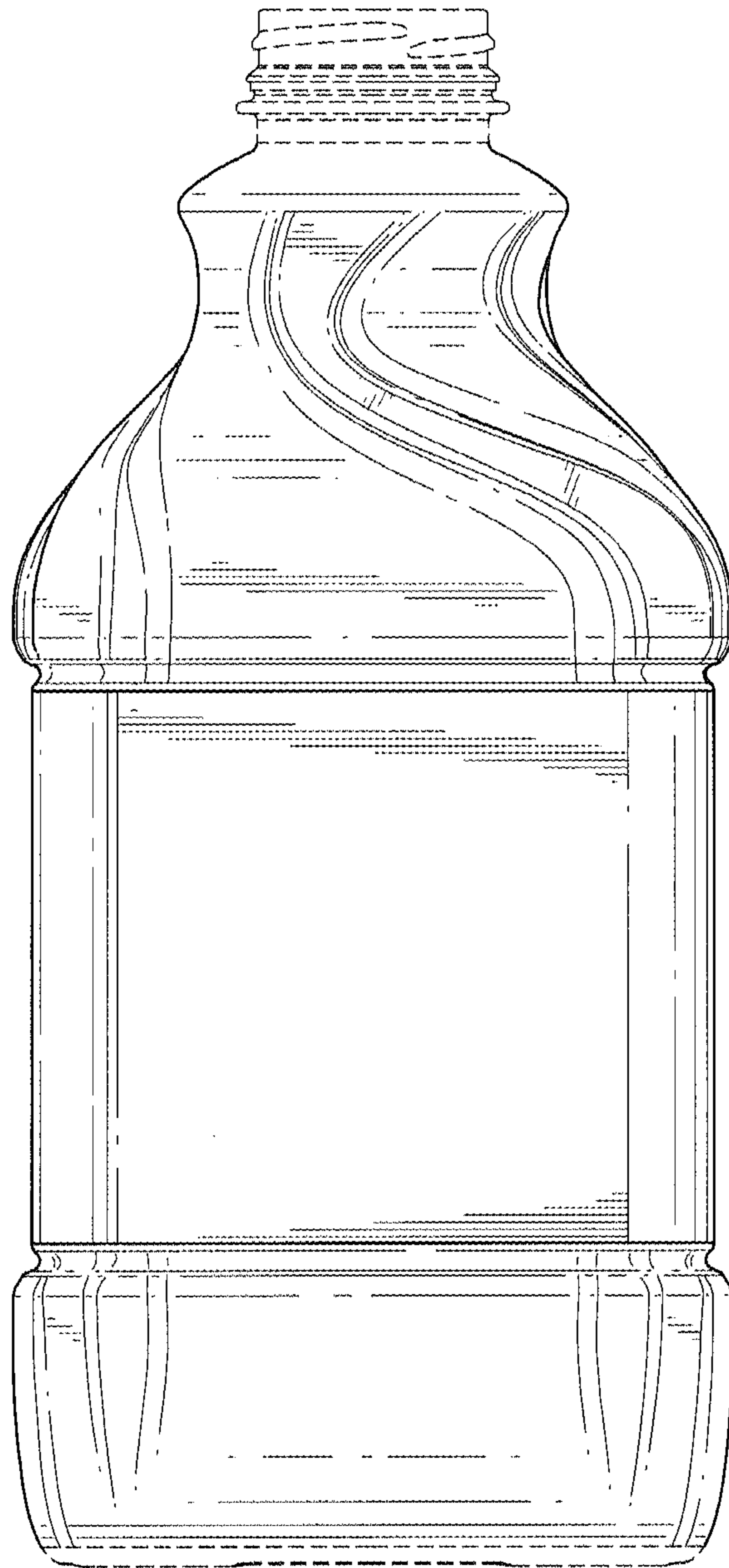

FIG. 20

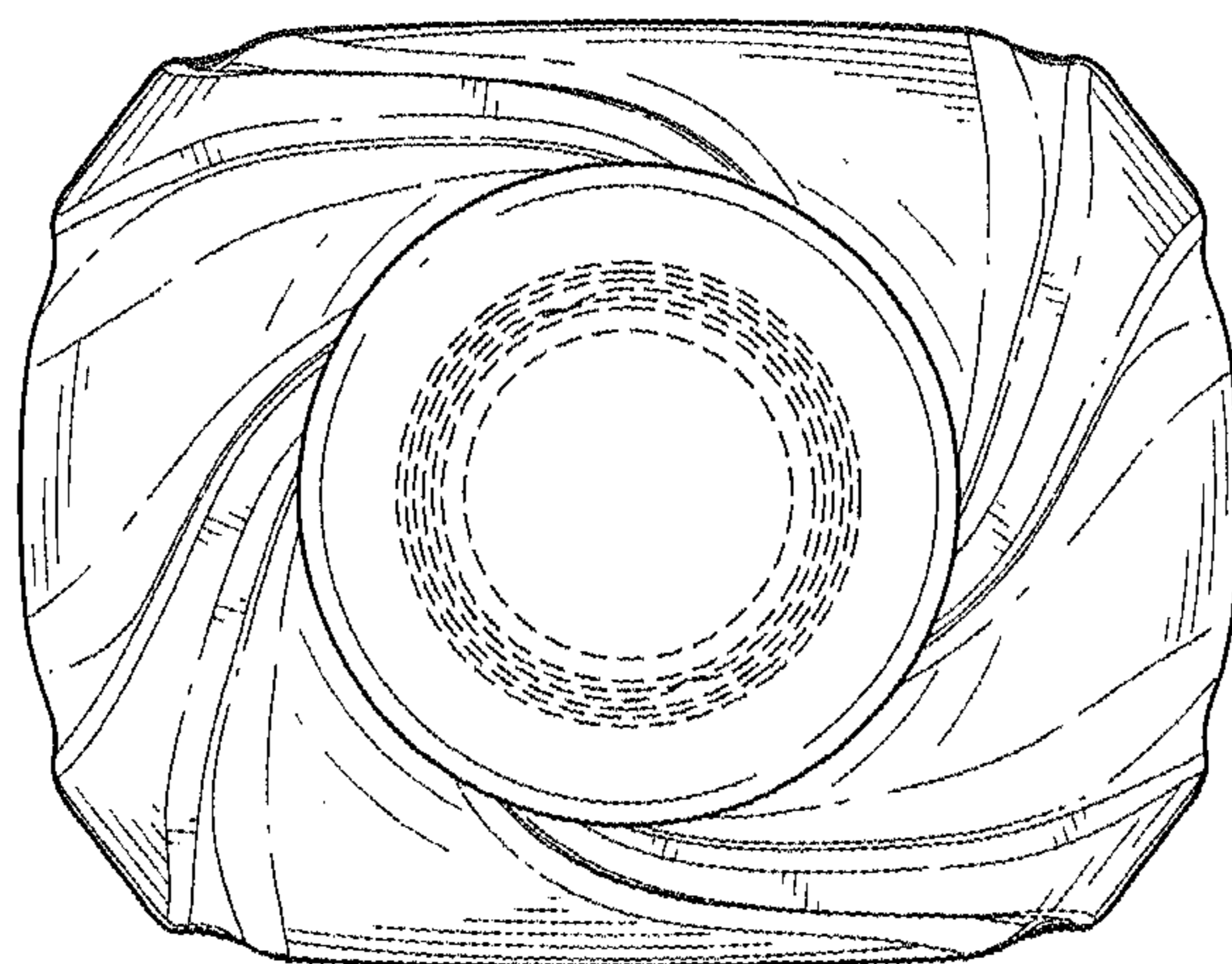

FIG. 21

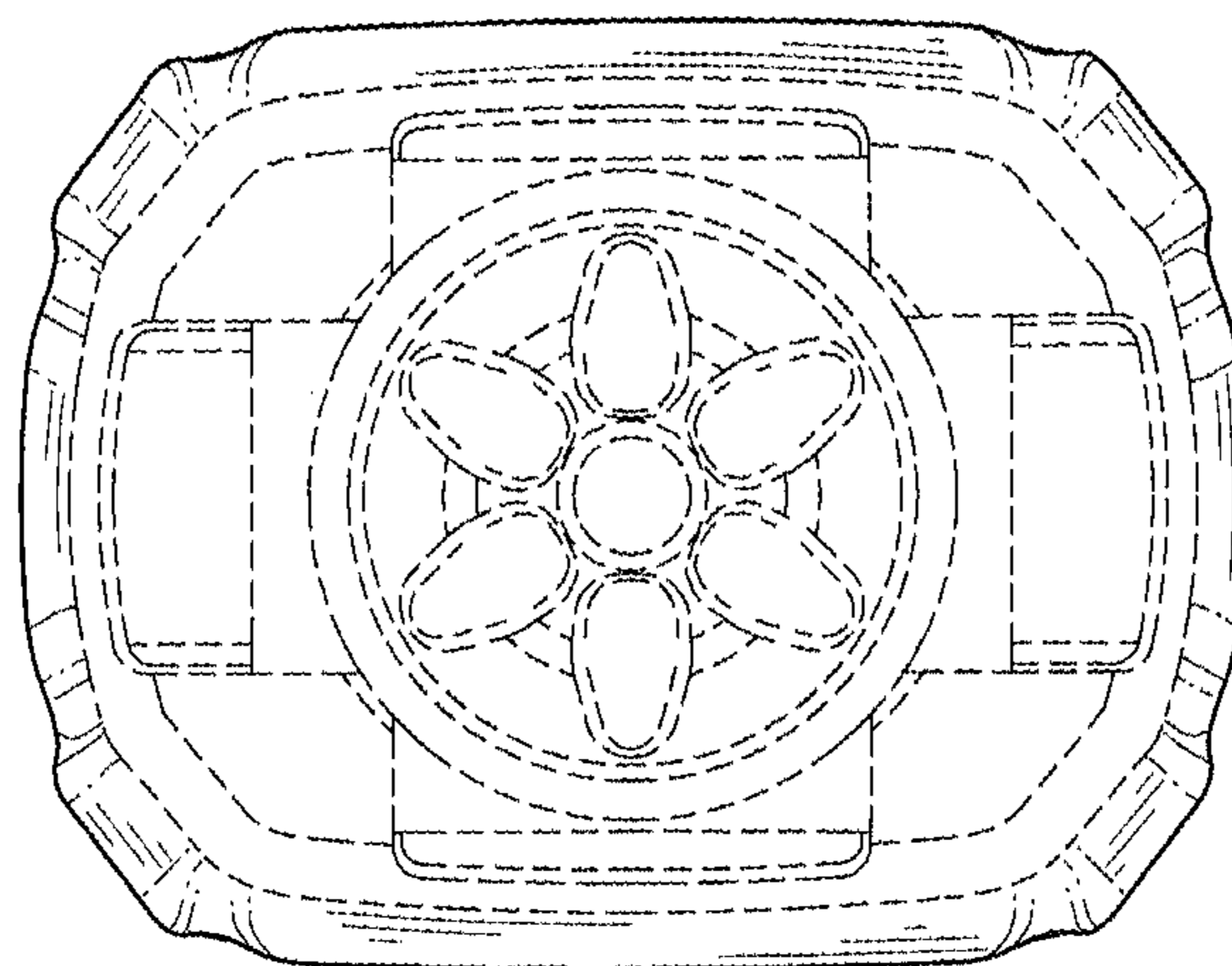

FIG. 22

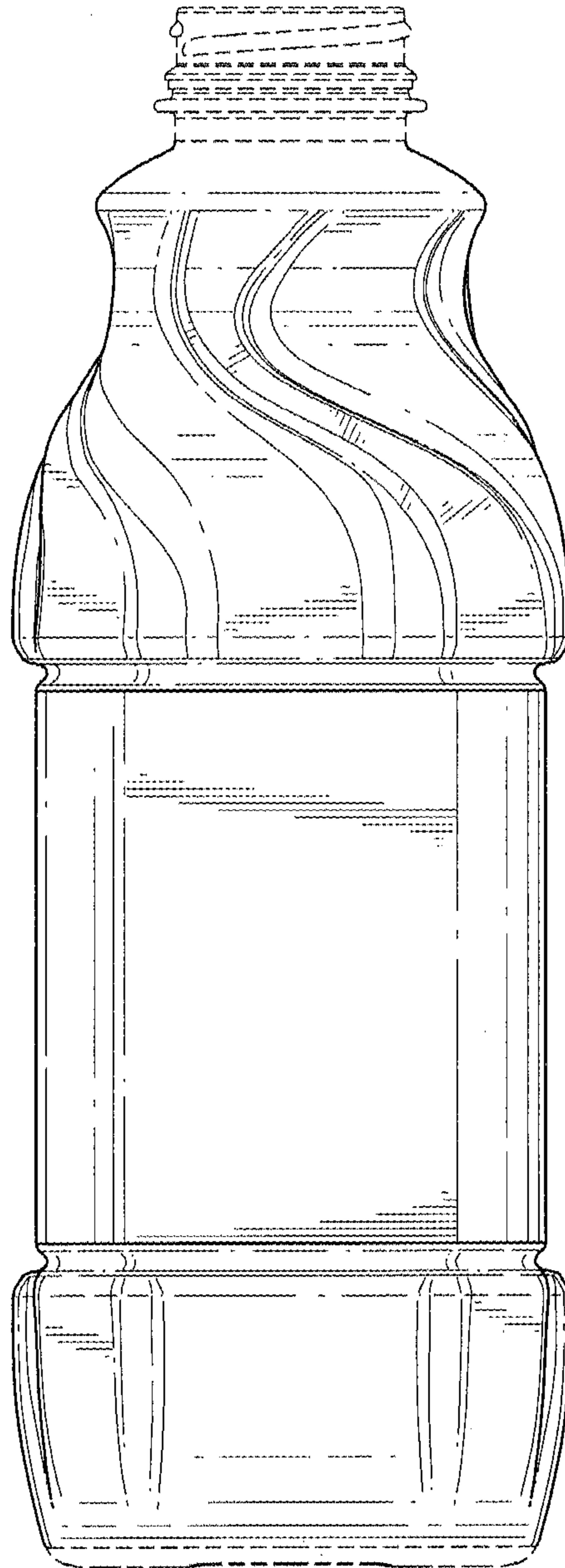

FIG. 23

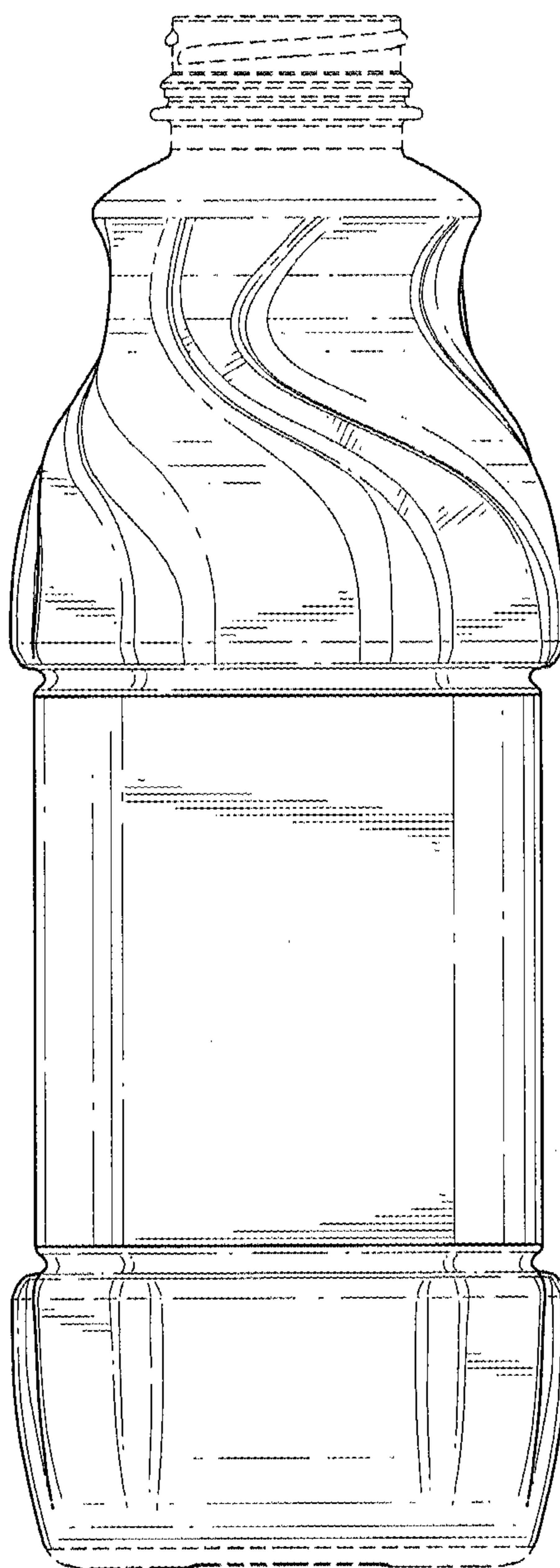

FIG. 24

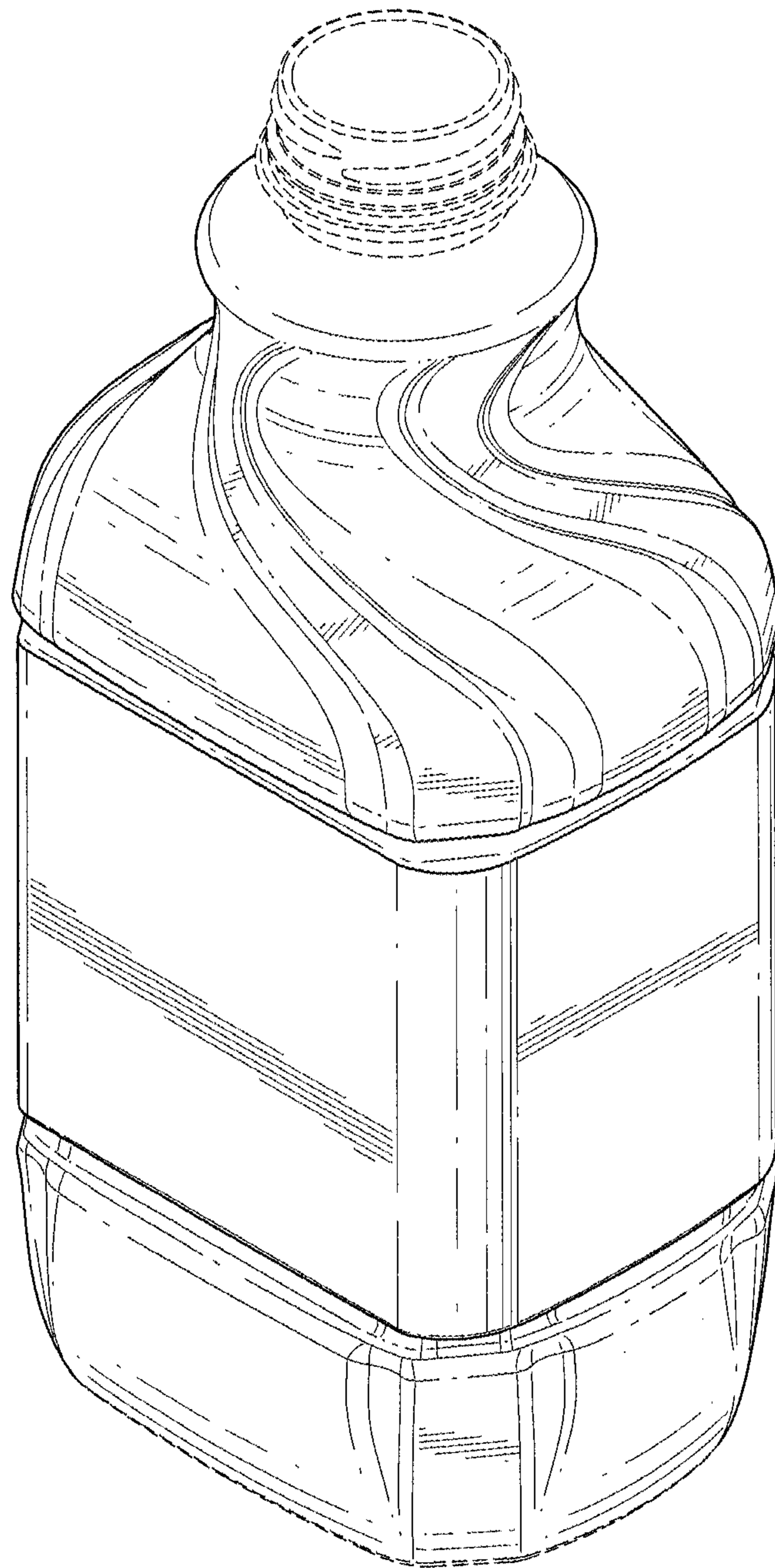

FIG. 25

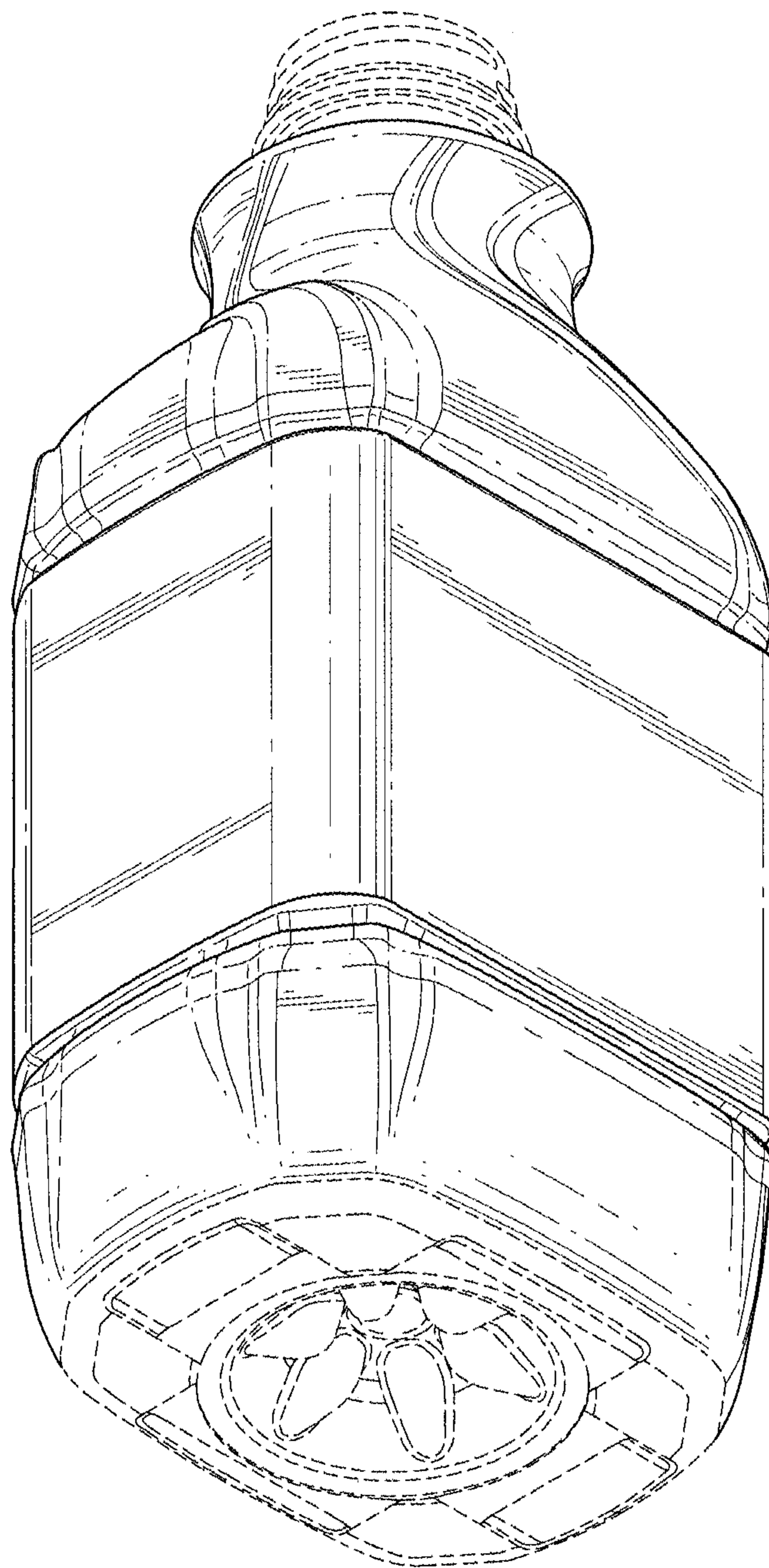

FIG. 26

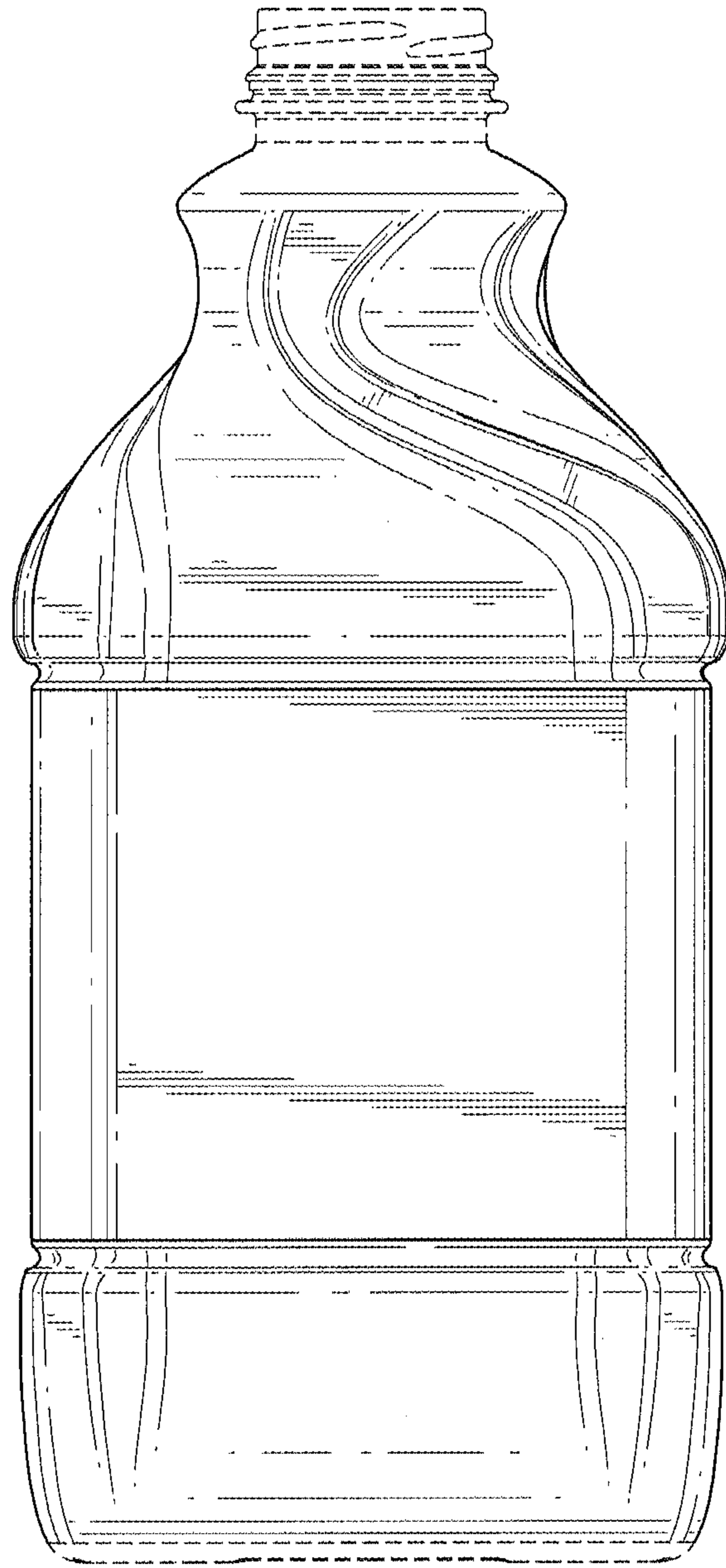

FIG. 27

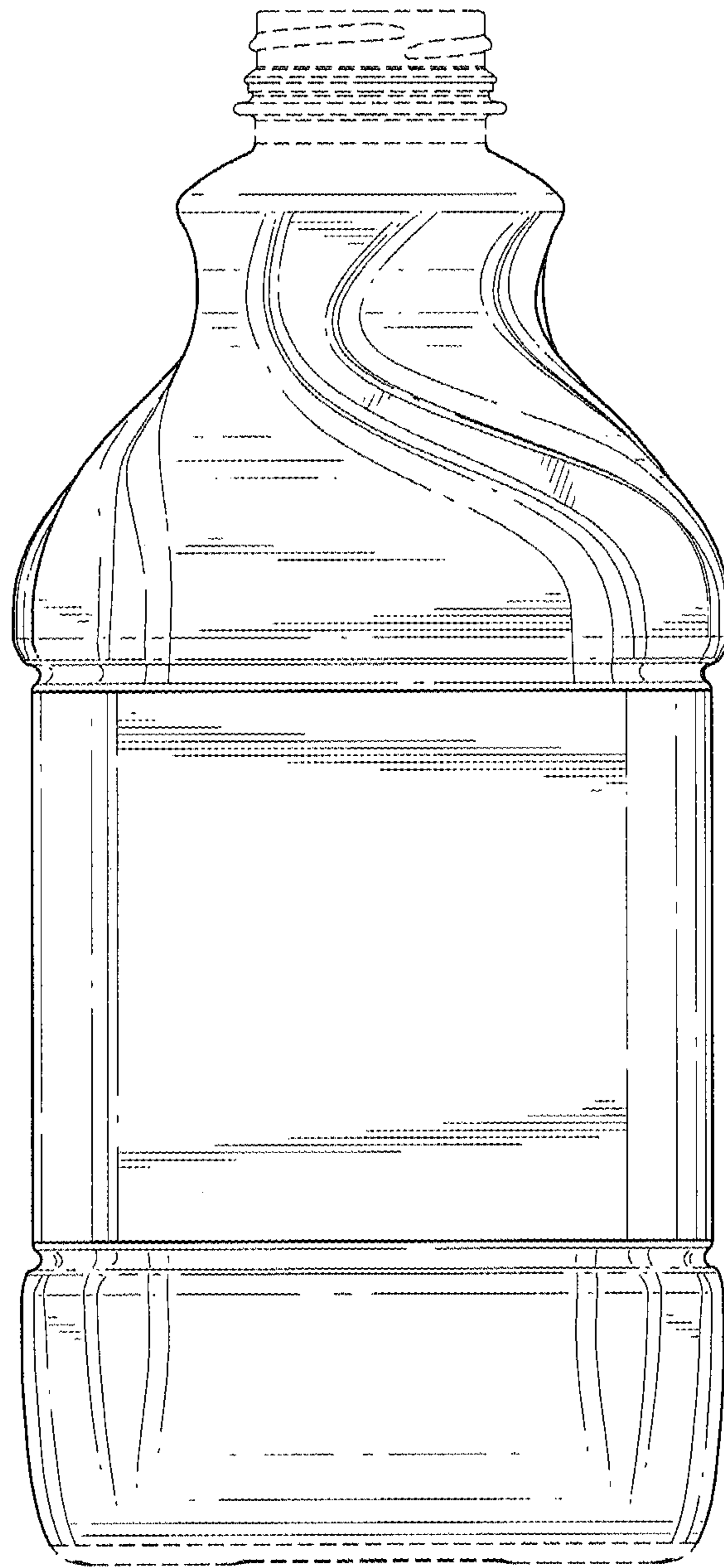

FIG. 28

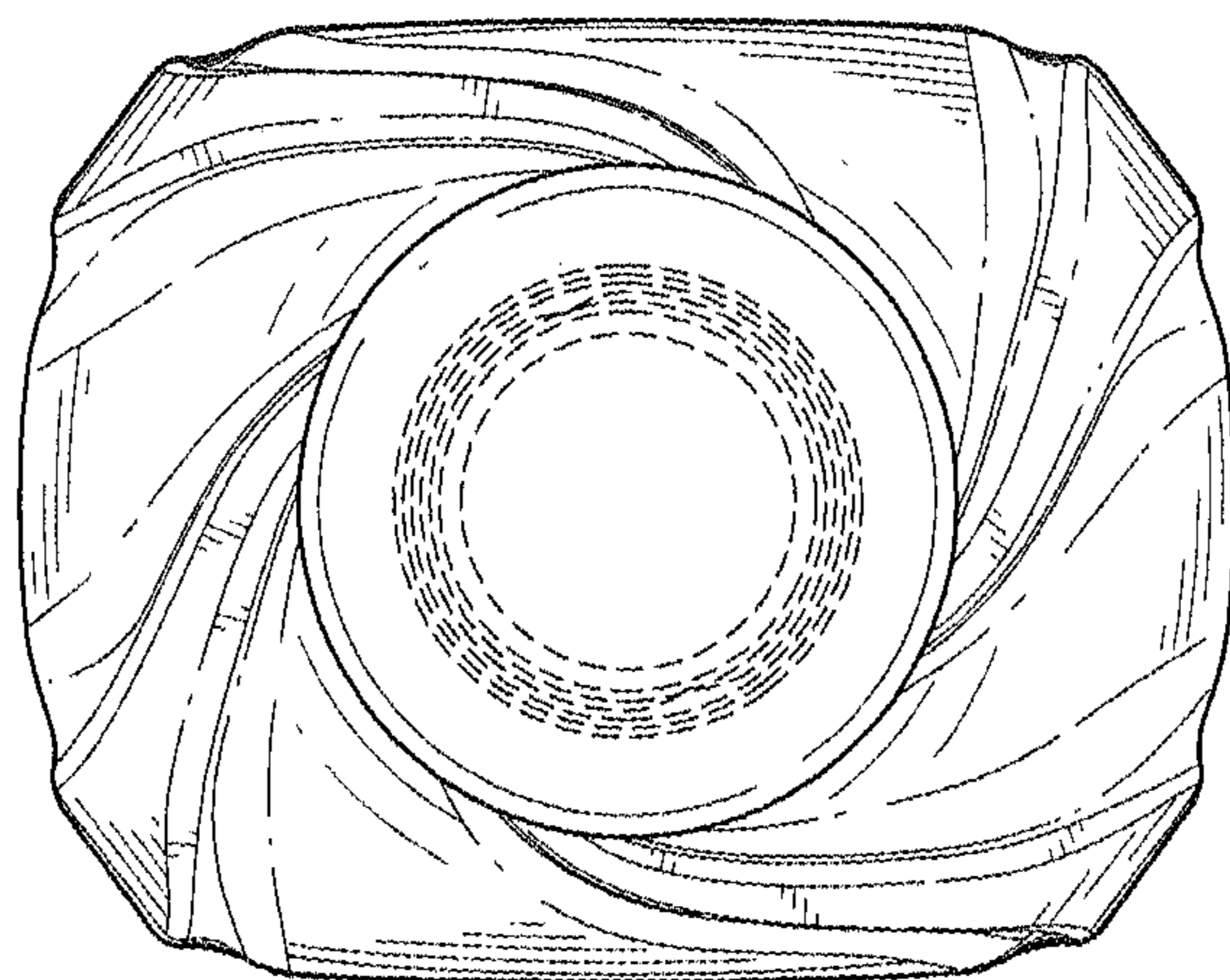

FIG. 29

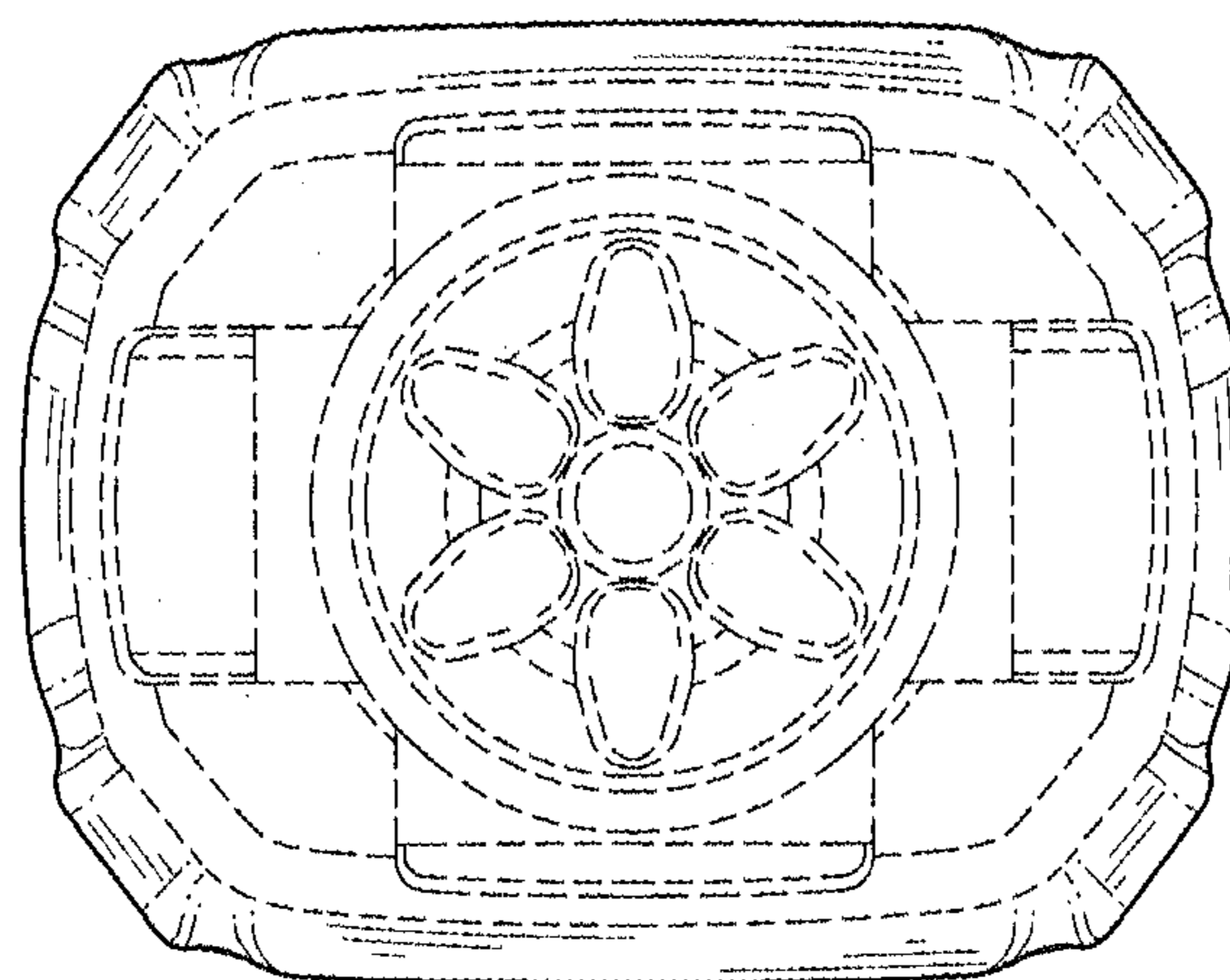

FIG. 30

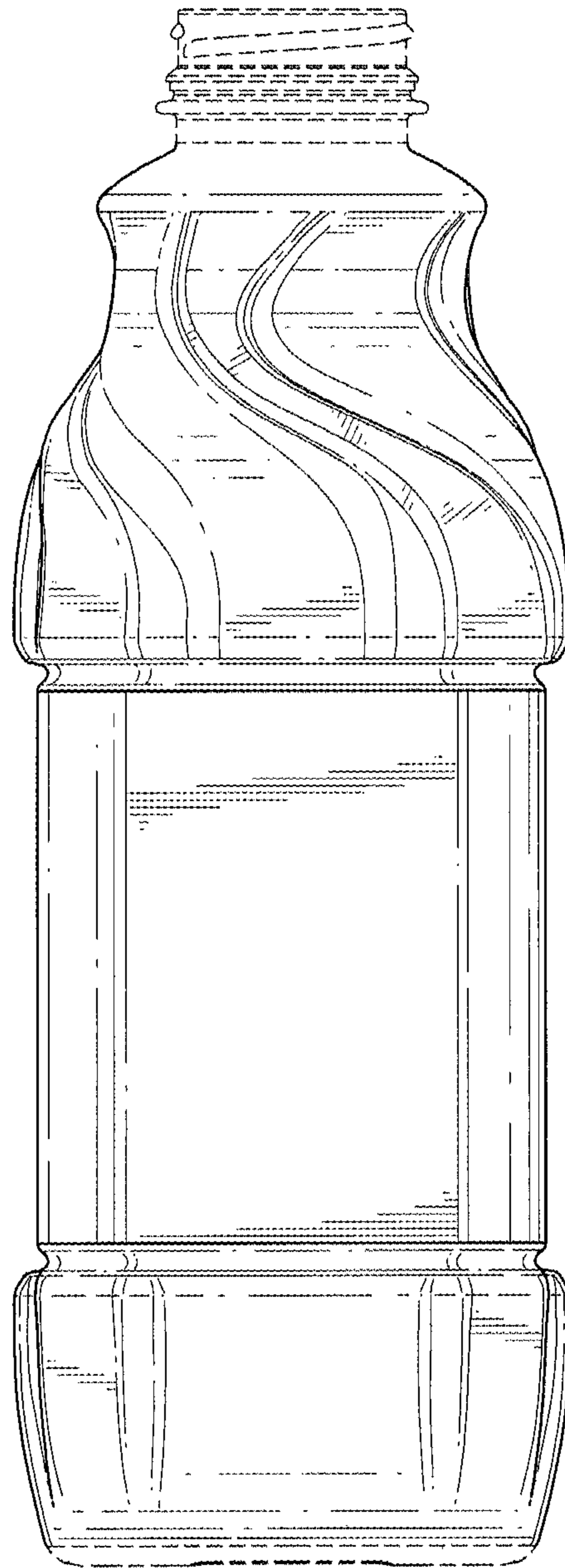

FIG. 31

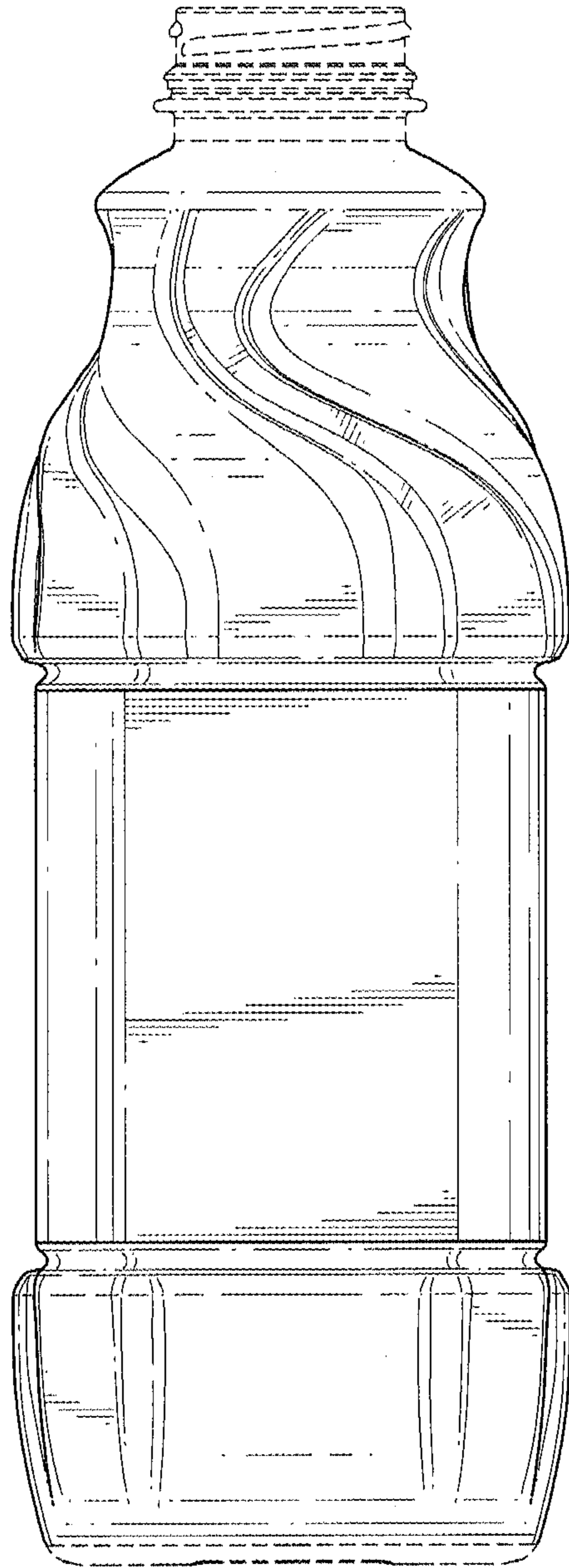

FIG. 32