



US00D743771S

(12) **United States Design Patent**
Lentine

(10) **Patent No.:** **US D743,771 S**

(45) **Date of Patent:** **** Nov. 24, 2015**

(54) **LATCH LOCK FOR A HANDLE**

E05B 85/12; E05B 85/10; E05B 7/00; E05B
1/0053; E05B 77/265

(71) Applicant: **Telebrands Corp.**, Fairfield, NJ (US)

See application file for complete search history.

(72) Inventor: **Lou Lentine**, Chattanooga, TN (US)

(56) **References Cited**

(73) Assignee: **Telebrands Corp.**, Fairfield, NJ (US)

U.S. PATENT DOCUMENTS

(**) Term: **14 Years**

(21) Appl. No.: **29/501,522**

(22) Filed: **Sep. 4, 2014**

(51) **LOC (10) Cl.** **08-06**

(52) **U.S. Cl.**
USPC **D8/302**; D8/308

(58) **Field of Classification Search**
USPC D8/300-302, 307-309, 331, DIG. 10;
D23/250, 252; 292/336.3; 74/523, 543,
74/545, 546, 547; 16/110.1, 412, 413,
16/422, 426, 429; 285/7; D15/143.1,
D15/144.1, 246.2; 403/104

CPC Y10T 16/44; Y10T 74/20612; Y10T
74/20732; Y10T 16/458; Y10T 16/498;
Y10T 16/469; Y10T 16/476; Y10T 74/20744;
Y10T 74/20864; Y10T 16/4828; Y10T
74/20642; Y10T 16/473; Y10T 74/20762;
Y10T 74/2042; Y10T 74/20828; Y10T
16/459; Y10T 16/4713; Y10T 74/2014;
Y10T 16/50; Y10T 74/20438; Y10T
74/20582; Y10T 74/20738; Y10T 16/48;
Y10T 74/20618; Y10T 74/20684; Y10T
74/20624; Y10T 74/20468; Y10T 16/61;
Y10T 16/4719; Y10T 16/86; Y10S 16/30;
Y10S 292/31; Y10S 292/53; Y10S 16/12;
Y10S 292/23; Y10S 292/27; Y10S 292/30;
Y10S 292/63; E05B 85/16; E05B 1/0015;
E05B 77/06; E05B 79/06; E05B 85/18;

1,354,710	A *	10/1920	Wise	285/7
D79,983	S *	11/1929	Raymond	D8/302
2,793,055	A	5/1957	Meyerhoefer		
2,817,548	A *	12/1957	Uthemann	403/104
3,633,942	A	1/1972	Meyerhoefer		
D228,227	S *	8/1973	Bako	D8/341
4,185,936	A *	1/1980	Takahashi	403/104
4,596,484	A *	6/1986	Nakatani	403/104
6,719,259	B2	4/2004	Huang et al.		
2014/0145127	A1 *	5/2014	Su	254/129

* cited by examiner

Primary Examiner — Derrick Holland

Assistant Examiner — Lauren Calve

(74) *Attorney, Agent, or Firm* — Cooper & Dunham LLP

(57) **CLAIM**

The ornamental design for a latch lock for a handle, as shown and described.

DESCRIPTION

FIG. 1 is a front perspective view of a latch lock for a handle in accordance with the present design;
FIG. 2 is a second front perspective view thereof, shown in an open configuration;
FIG. 3 is a front view of the latch lock for a handle of FIG. 1;
FIG. 4 is a back view thereof;
FIG. 5 is a right side view thereof;
FIG. 6 is a left side view thereof;
FIG. 7 is a top view thereof; and,
FIG. 8 is a bottom view thereof.
The broken lines represent unclaimed subject matter and form no part of the claimed design.

1 Claim, 4 Drawing Sheets

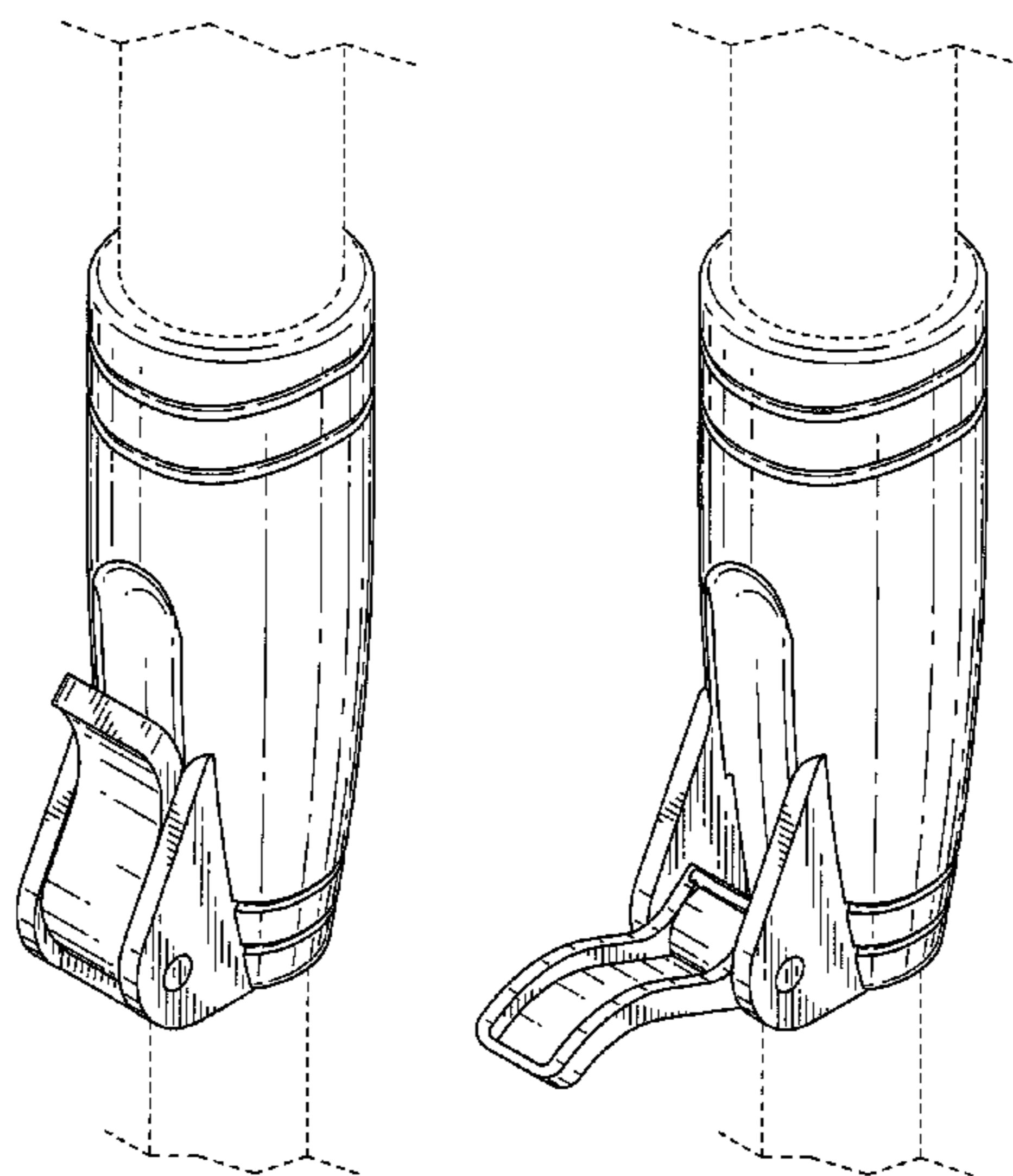

FIG. 1

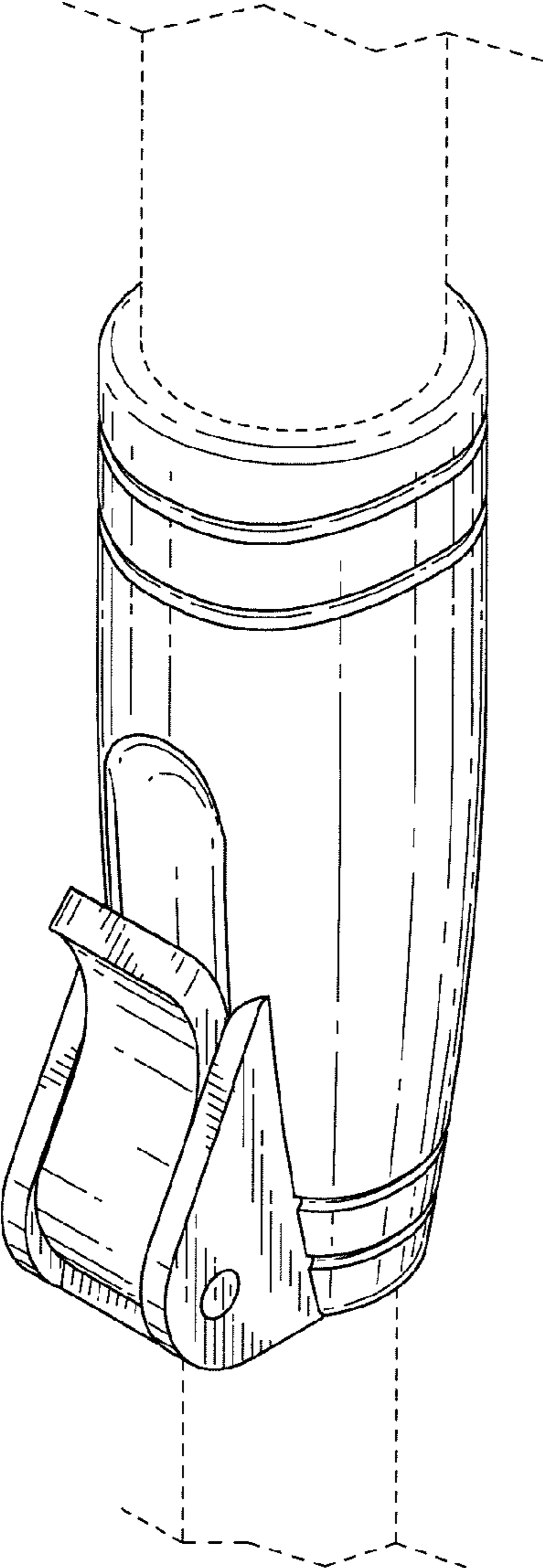

FIG. 2

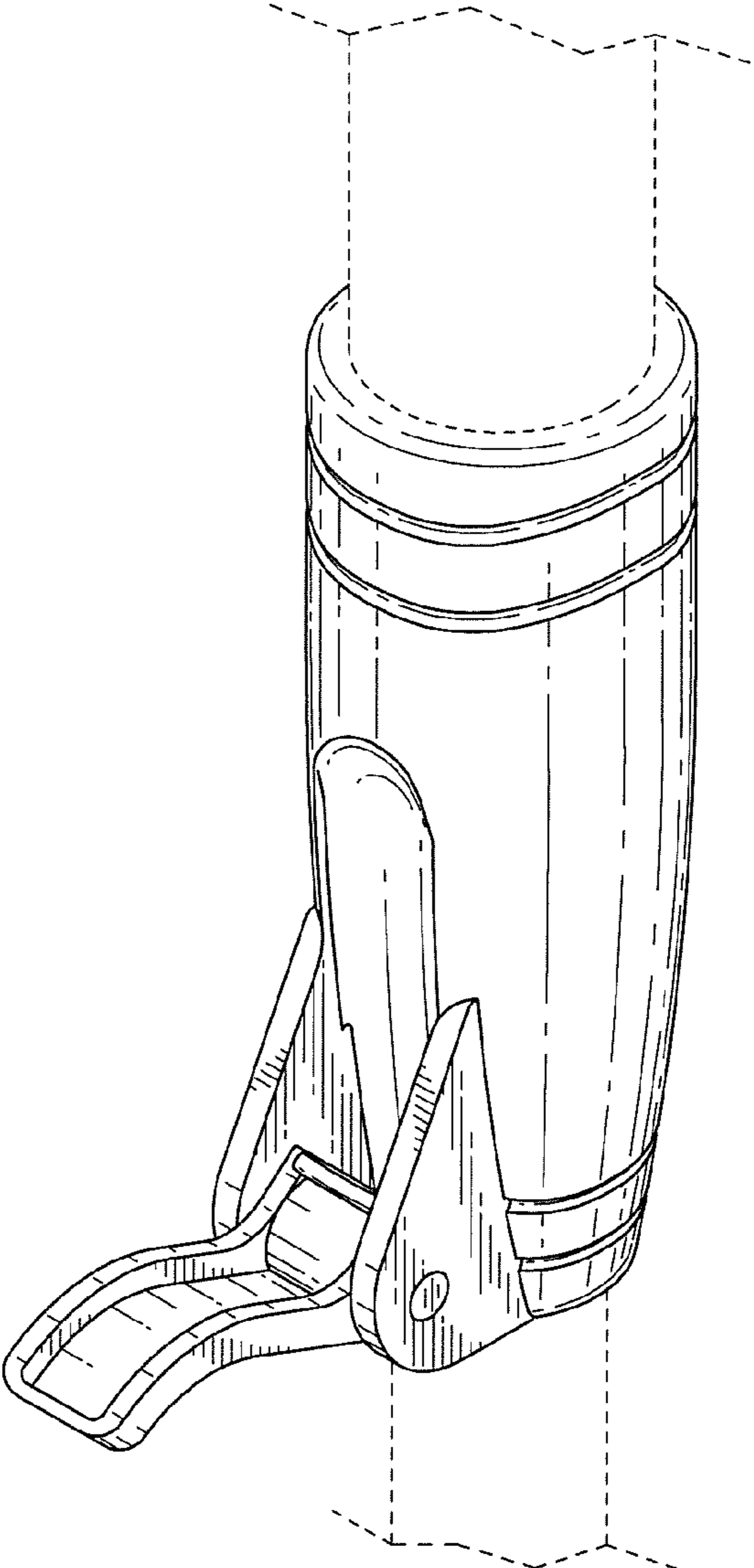

FIG. 3

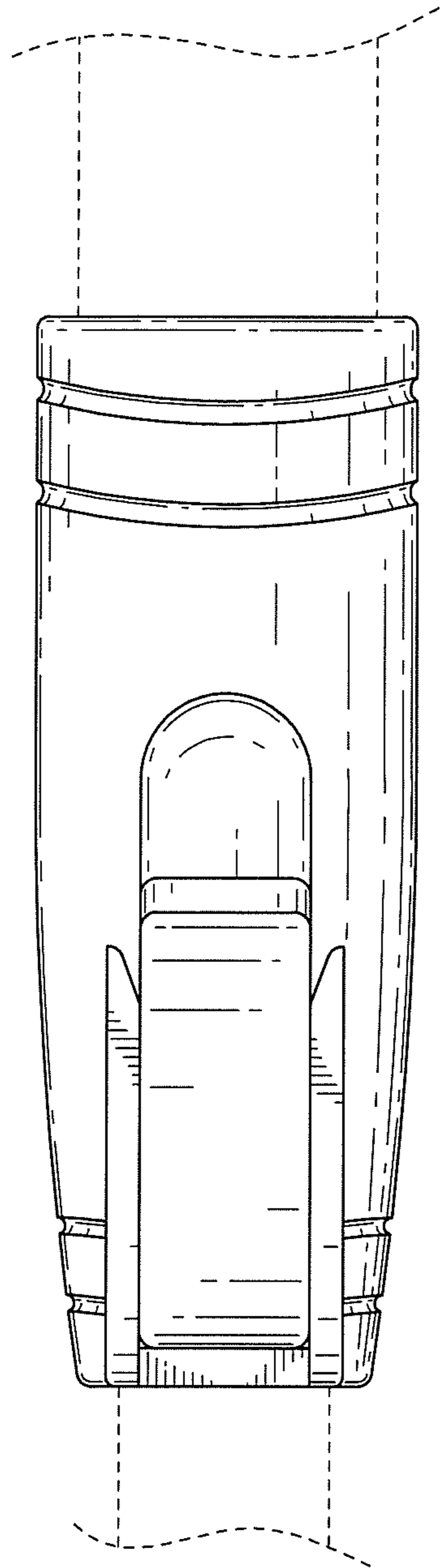

FIG. 4

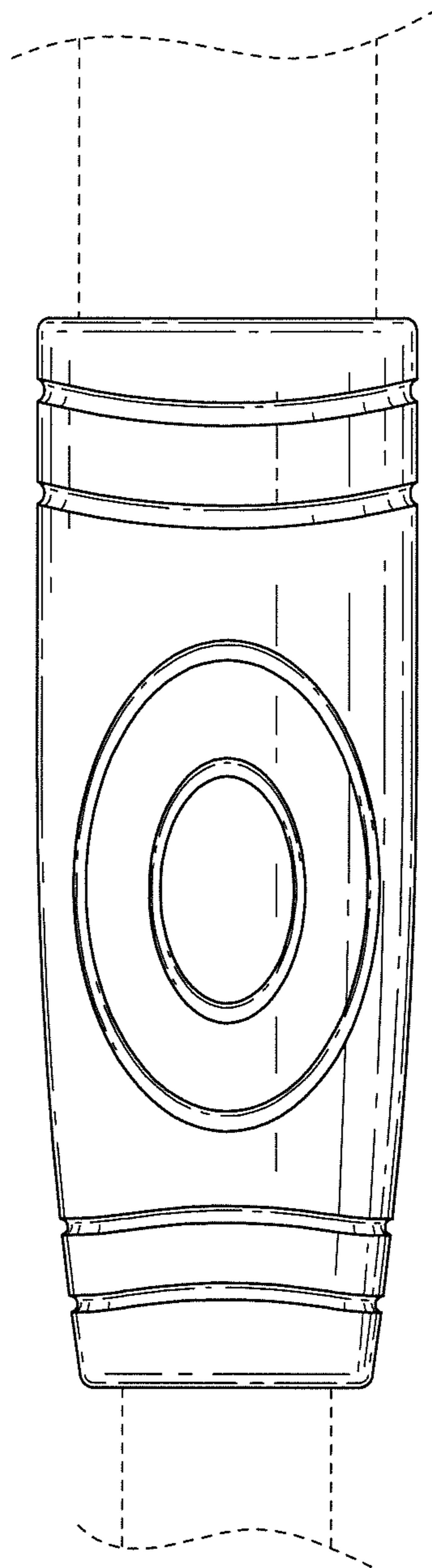

FIG. 5

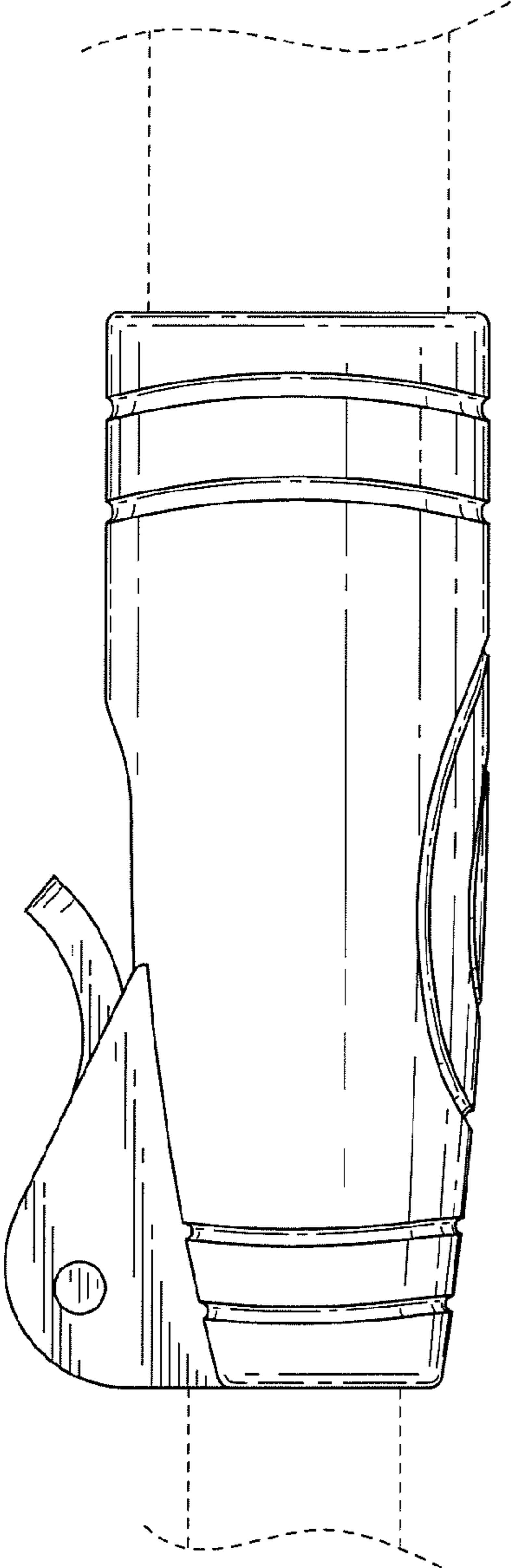

FIG. 6

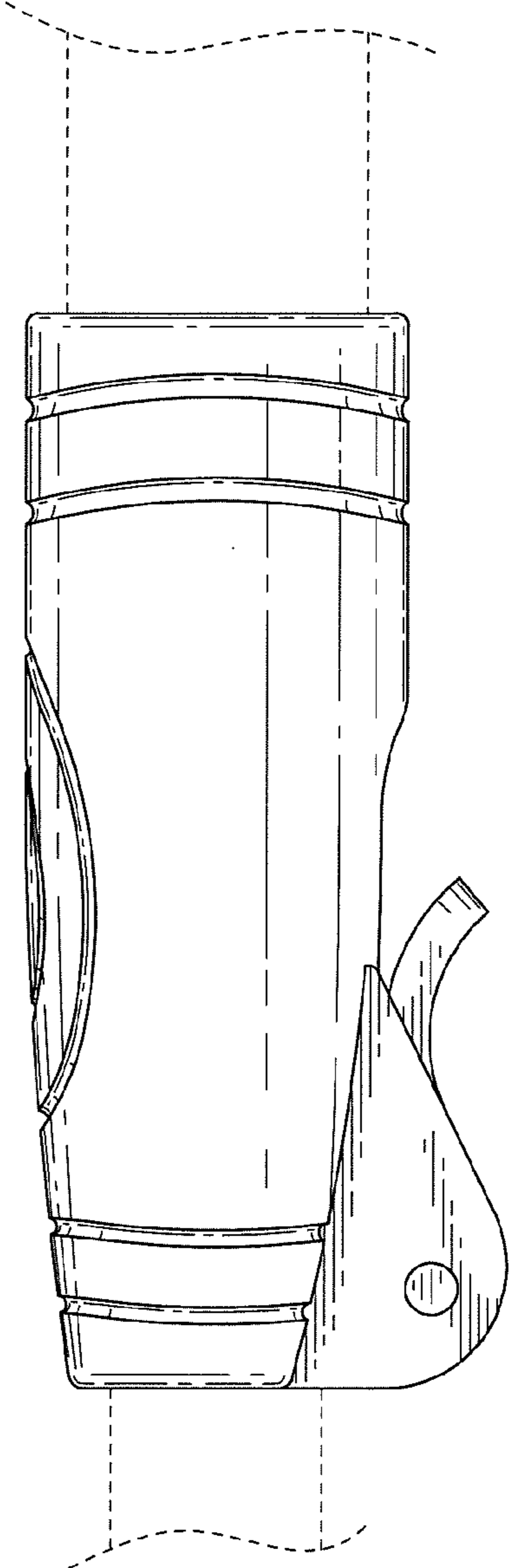

FIG. 7

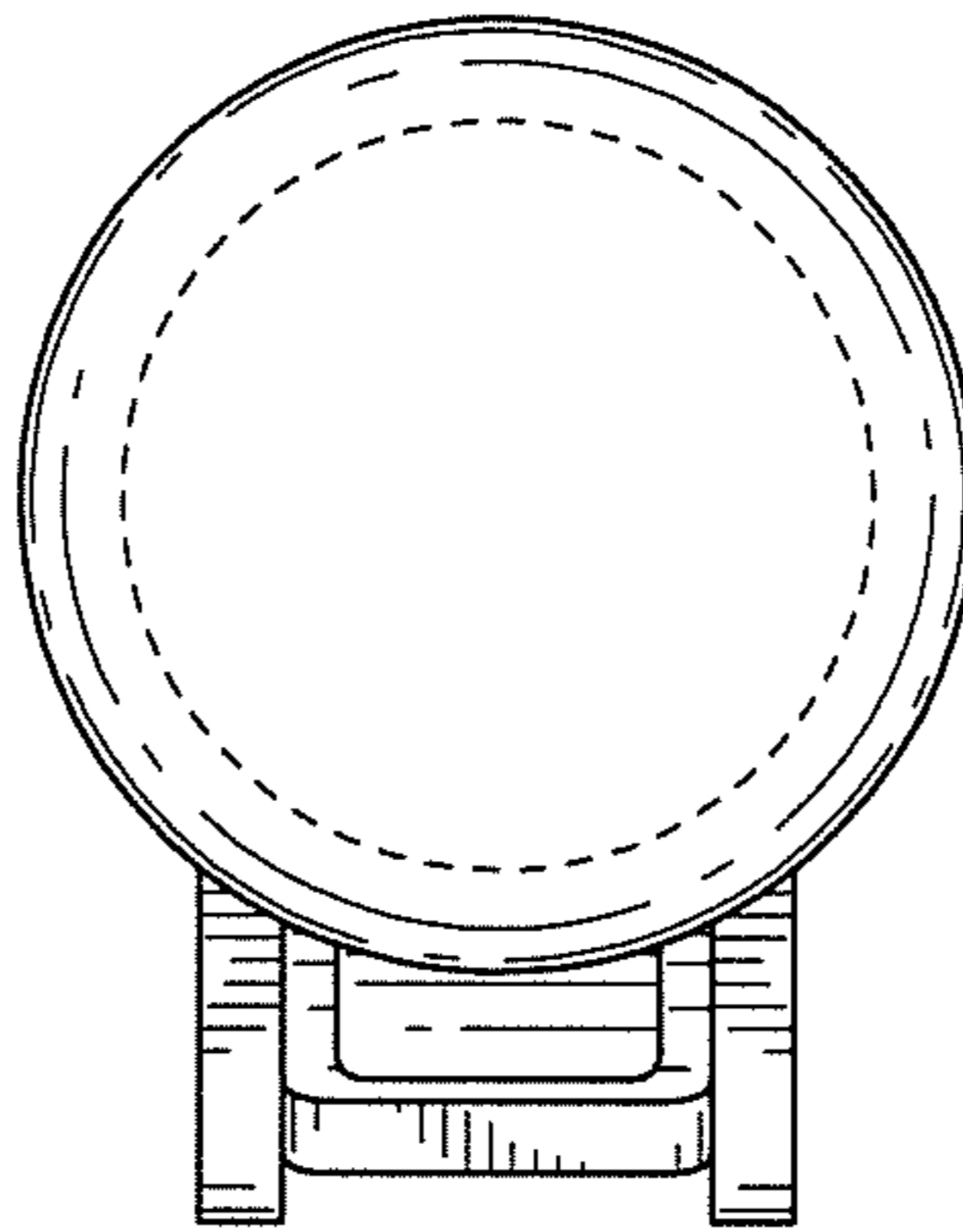

FIG. 8

