



US00D743667S

(12) **United States Design Patent**  
**Anderson**

(10) **Patent No.:** **US D743,667 S**  
(45) **Date of Patent:** **\*\* Nov. 24, 2015**

(54) **DISTRESS BANDANA**

(71) Applicant: **John E Anderson**, Dawson, IL (US)

(72) Inventor: **John E Anderson**, Dawson, IL (US)

(\*\*) Term: **14 Years**

(21) Appl. No.: **29/498,867**

(22) Filed: **Aug. 8, 2014**

(51) **LOC (10) Cl.** ..... **02-05**

(52) **U.S. Cl.**

USPC ..... **D2/502**; D10/109.1

(58) **Field of Classification Search**

USPC ..... D2/500, 501, 502, 503, 504, 508, 600,  
D2/602, 604, 823, 824, 825, 826, 880, 881,  
D2/882; D30/145; D10/109.1, 109.2, 110;  
D11/165, 172, 174; D12/401

CPC ..... A41D 23/00; A41D 2023/002; A41D  
2023/004; A41D 2023/008; A41D 13/1107;  
A41D 13/11; A42B 1/04; A42B 1/041;  
A42B 1/066; A42B 1/008; A42B 5/00;  
B60Q 7/00; B60Q 7/005; B60Q 7/02; B60R  
13/00; B60R 13/005; A61F 17/00; A62B  
3/00; F41H 5/08; B43L 3/00; B43L 3/004;  
B43L 3/005

See application file for complete search history.

(56) **References Cited**

**U.S. PATENT DOCUMENTS**

D29,651 S *	11/1898	Shoenberg	.....	D2/826
1,286,208 A *	12/1918	Bernau	.....	281/45
D108,024 S *	1/1938	Stone	.....	D19/92
D124,163 S *	12/1940	Berger	.....	D2/825
D183,646 S *	10/1958	Cash	.....	D2/502
3,239,957 A	3/1966	Snediker		
3,671,977 A *	6/1972	Degnon	.....	2/207
4,471,873 A	9/1984	Thomas		

D313,214 S *	12/1990	Phillips et al.	.....	D12/223
5,195,264 A	3/1993	Johanson et al.		
5,226,792 A	7/1993	Darago		
D340,417 S *	10/1993	Popp et al.	.....	D10/109.1
5,594,956 A *	1/1997	Barrientos	.....	2/207
6,178,676 B1 *	1/2001	Lund	.....	40/591
D470,704 S *	2/2003	Varon	.....	D6/608
6,825,760 B2 *	11/2004	Sawyer et al.	.....	340/463
7,636,953 B2	12/2009	Grey		
9,010,231 B1 *	4/2015	Cohn et al.	.....	89/36.07
D728,451 S *	5/2015	Rodriguez	.....	D12/401
2006/0041993 A1	3/2006	Elea		
2011/0209710 A1 *	9/2011	Spencer, III	.....	128/206.12

**OTHER PUBLICATIONS**

“John E. Anderson | Distress Bandanna,” video uploaded to youtube on Nov. 17, 2014. Retrieved from the internet on Jul. 6, 2015. URL: <https://www.youtube.com/watch?v=IcU0oHs3EAE>. (1 page).\*

\* cited by examiner

*Primary Examiner* — Karen E. Eldridge Powers

*Assistant Examiner* — Jasmine Mlinarcik

(74) *Attorney, Agent, or Firm* — Robert Montgomery; Montgomery Patent & Design, LP

(57) **CLAIM**

The ornamental design for a distress bandana, as shown and described.

**DESCRIPTION**

FIG. 1 is a perspective view of a distress bandana;  
FIG. 2 is a front elevation view thereof;  
FIG. 3 is a rear elevation view thereof;  
FIG. 4 is a left-hand side elevation view thereof;  
FIG. 5 is right-hand side elevation view thereof;  
FIG. 6 is a top plan view thereof; and,  
FIG. 7 is a bottom plan view thereof.

**1 Claim, 7 Drawing Sheets**

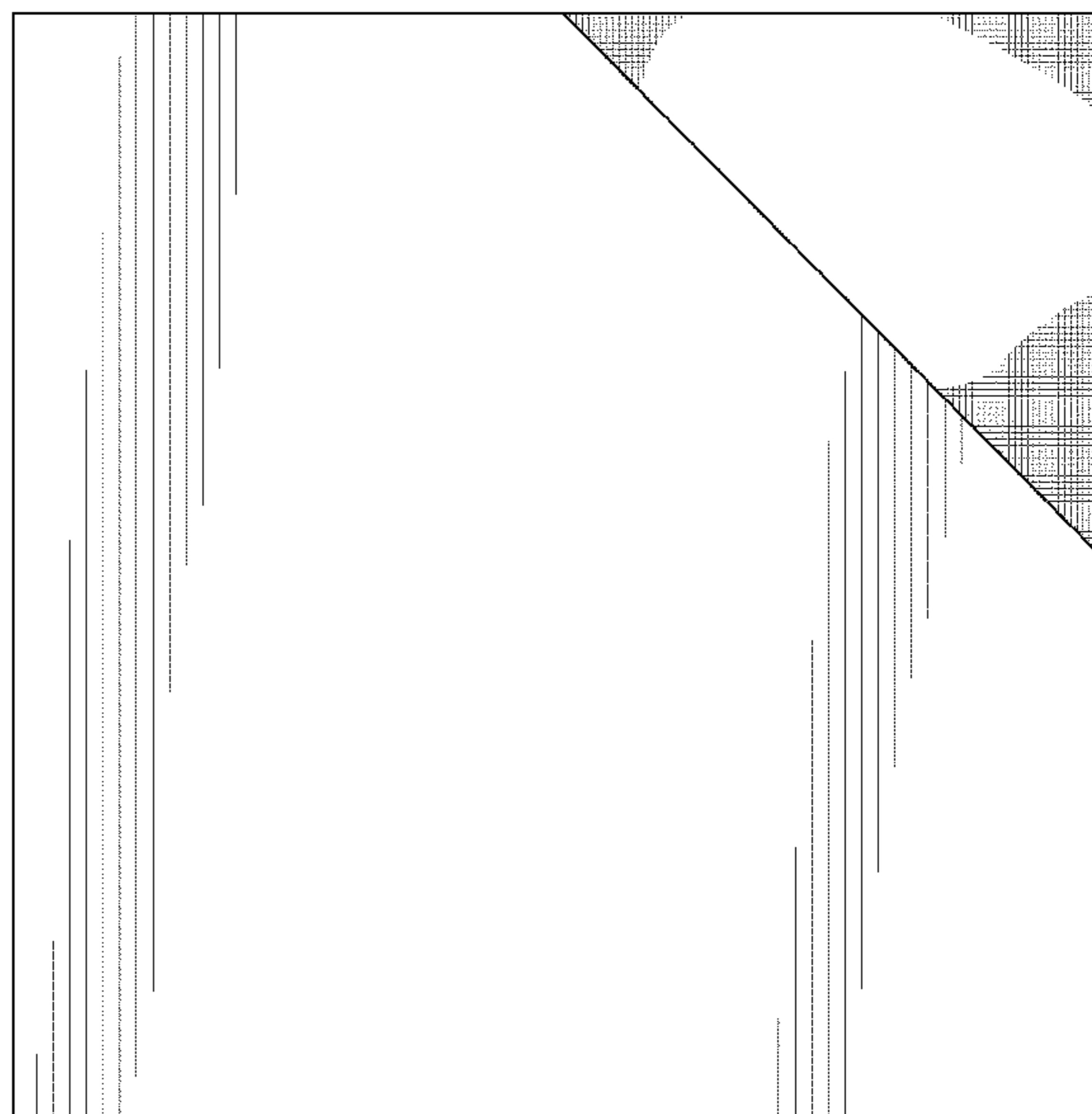
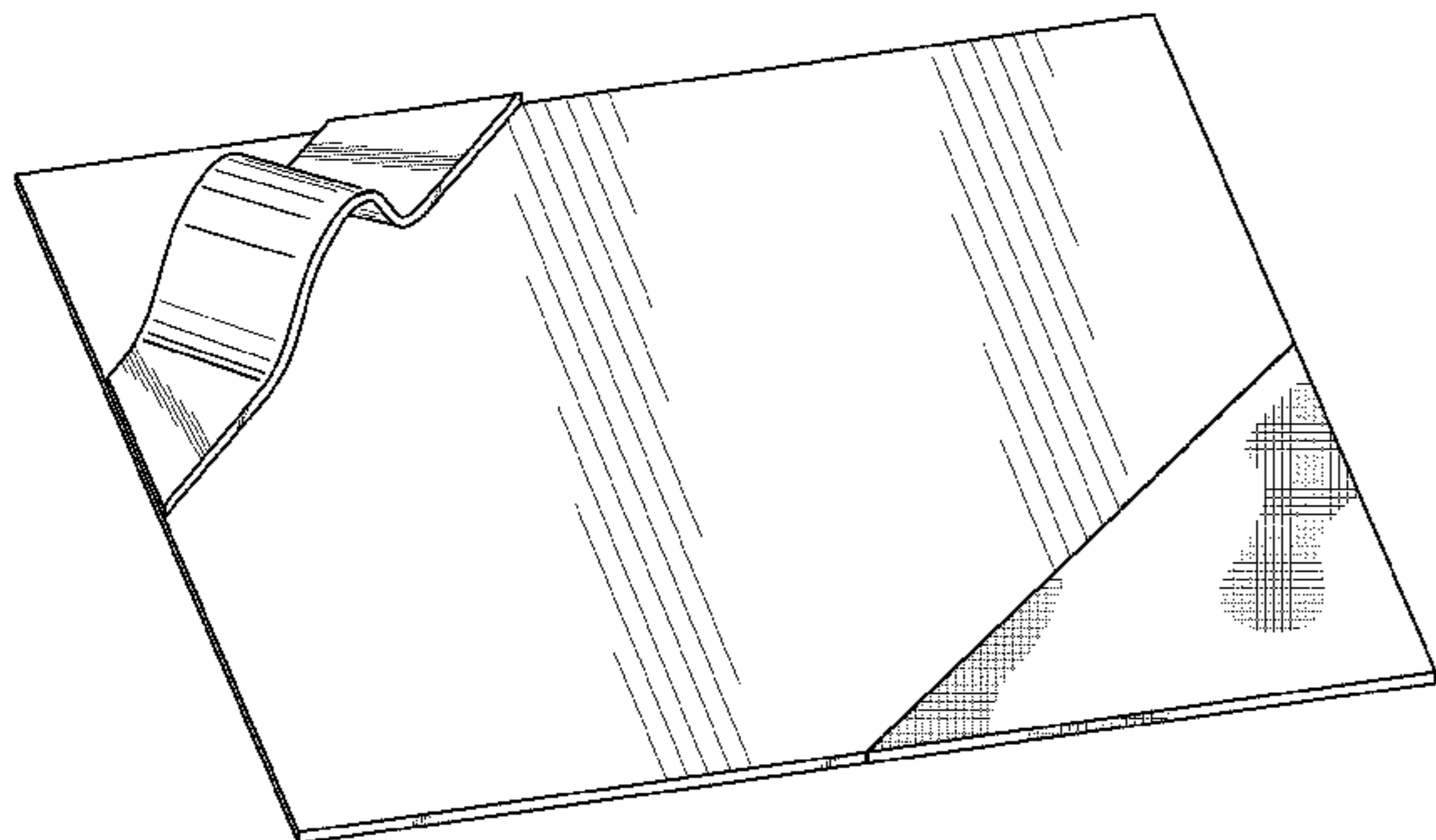

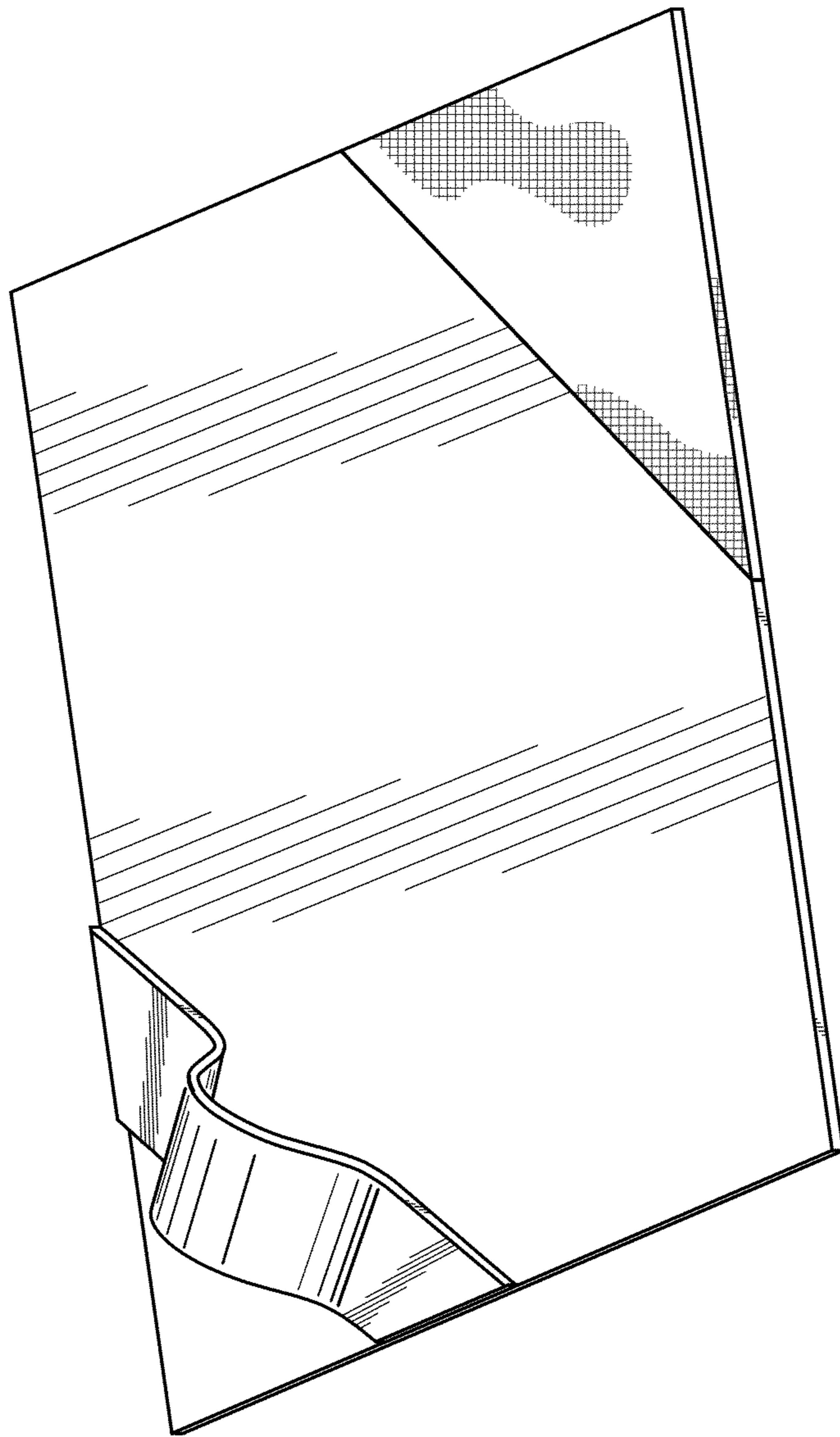

Fig. 1

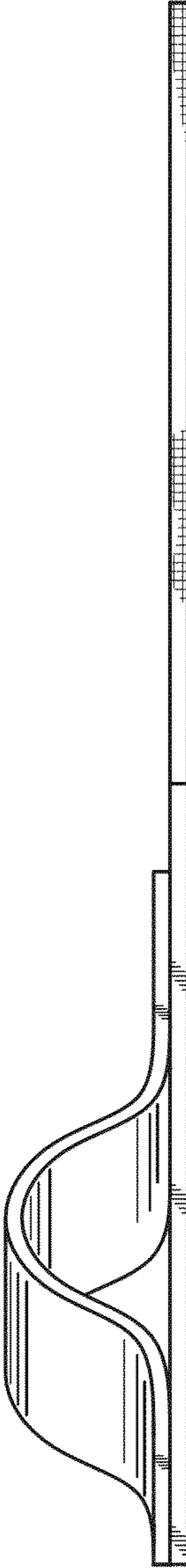

Fig. 2

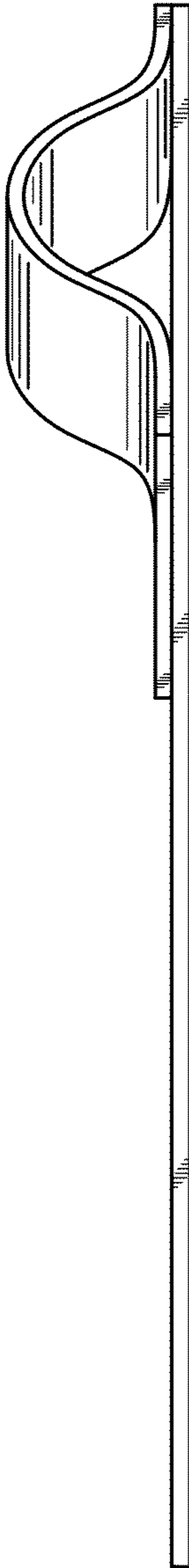

Fig. 3

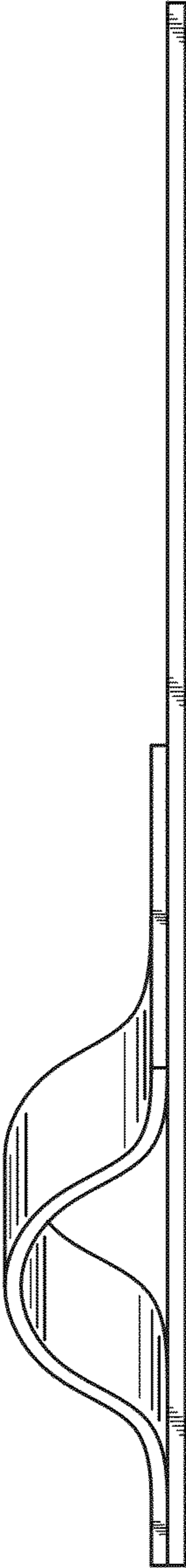

Fig. 4

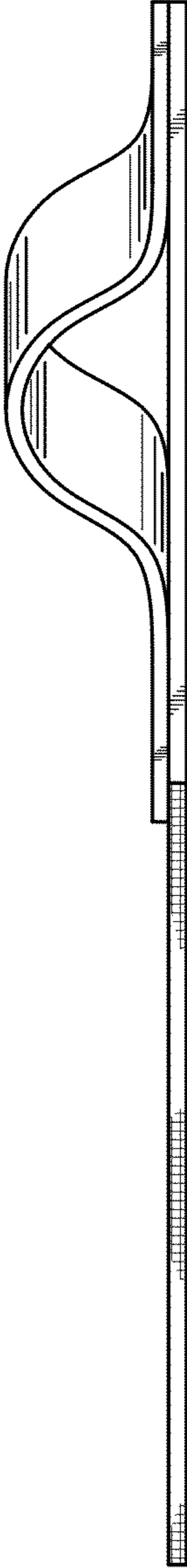

Fig. 5

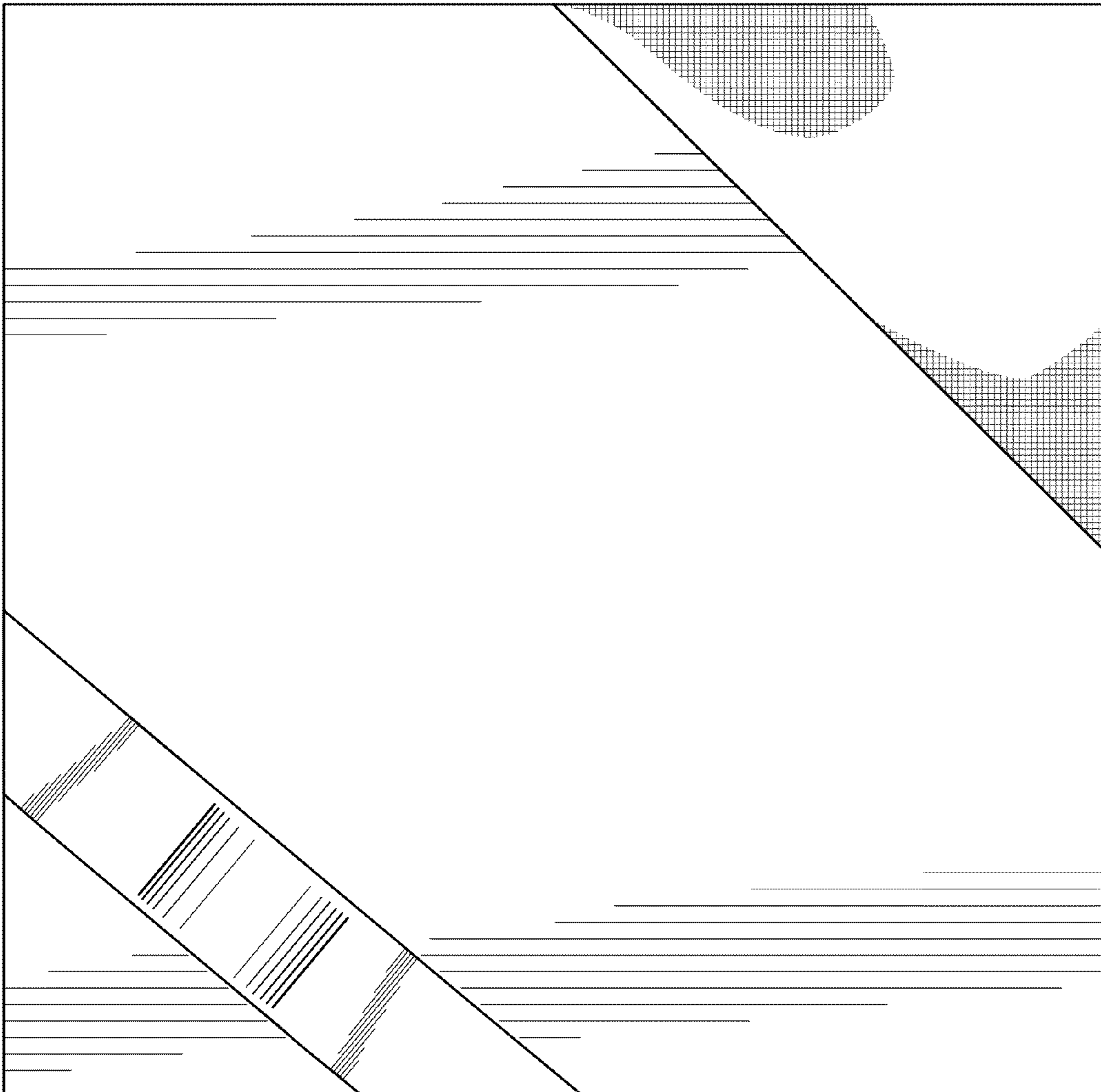

Fig. 6

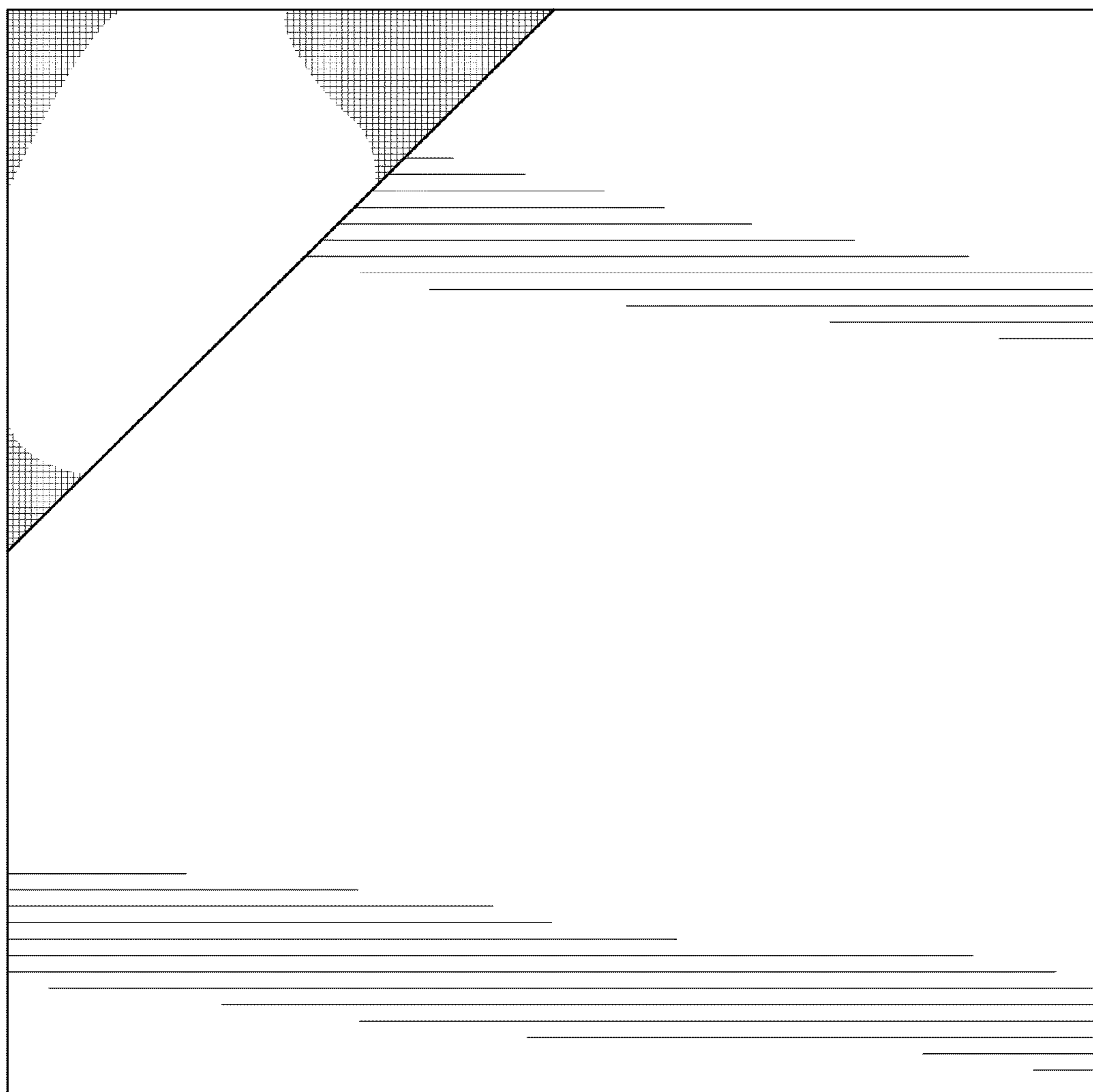

Fig. 7