



US00D743504S

(12) **United States Design Patent**  
**Hall et al.**

(10) **Patent No.:** **US D743,504 S**

(45) **Date of Patent:** **\*\* Nov. 17, 2015**

(54) **LIGHTED NET FRAME**

(71) Applicant: **GLOBAL PRODUCTS INTERNATIONAL GROUP, LLC**,  
Atlanta, GA (US)

(72) Inventors: **Andrew Hayward Hall**, Wedowee, AL (US); **Gabriel Paul Chapman, II**, Atlanta, GA (US); **Gabriel Paul Chapman**, Cumming, GA (US); **James Hayward Hall**, Wedowee, AL (US)

(73) Assignee: **Global Products International Group, LLC**, Atlanta, GA (US)

(\*\*) Term: **14 Years**

(21) Appl. No.: **29/497,245**

(22) Filed: **Jul. 22, 2014**

(51) **LOC (10) Cl.** ..... **22-05**

(52) **U.S. Cl.**  
USPC ..... **D22/135**

(58) **Field of Classification Search**  
USPC ..... D22/135, 134; D21/729; 43/7, 10-12, 43/17.5; 362/109, 119  
See application file for complete search history.

(56) **References Cited**

**U.S. PATENT DOCUMENTS**

- 524,942 A \* 8/1894 Holmes ..... A01K 77/00 43/12
- 956,803 A \* 5/1910 Fromm ..... A01K 77/00 43/12
- 2,791,676 A \* 5/1957 Cote ..... A01K 87/08 362/119
- 3,077,693 A \* 2/1963 Wallin ..... A01K 77/00 362/109
- 4,446,646 A \* 5/1984 van't Veld ..... A01K 77/00 43/12
- D355,461 S \* 2/1995 Feeney ..... D10/125
- 5,568,697 A \* 10/1996 Schwartz ..... A01K 77/00 43/12
- D469,154 S \* 1/2003 French ..... D22/135
- D549,800 S \* 8/2007 Corbett ..... D22/135

- D587,324 S \* 2/2009 Sokol ..... D21/729
- 7,603,805 B1 \* 10/2009 Lehmborg ..... A01K 97/10 43/11
- D686,691 S \* 7/2013 Blood ..... D22/135
- D735,823 S \* 8/2015 Malaby ..... D21/729

\* cited by examiner

*Primary Examiner* — Catheri Oliver-Garcia

(74) *Attorney, Agent, or Firm* — Sutherland Asbill & Brennan LLP

(57) **CLAIM**

The ornamental design for a lighted net frame, as shown and described.

**DESCRIPTION**

FIG. 1 is a top view of a lighted net frame according to an embodiment of the disclosure;  
 FIG. 2 is a bottom view thereof;  
 FIG. 3 is a first side view thereof;  
 FIG. 4 is a second side view thereof;  
 FIG. 5 is a front view thereof;  
 FIG. 6 is a rear view thereof;  
 FIG. 7 is a forward upper perspective view thereof;  
 FIG. 8 is a rear upper perspective view thereof;  
 FIG. 9 is another top view thereof;  
 FIG. 10 is another bottom view thereof;  
 FIG. 11 is another first side view thereof;  
 FIG. 12 is another second side view thereof;  
 FIG. 13 is another front view thereof;  
 FIG. 14 is another rear view thereof;  
 FIG. 15 is another forward upper perspective view thereof;  
 FIG. 16 is another rear upper perspective view thereof;  
 FIG. 17 is a top view of a lighted net frame according to another embodiment of the disclosure;  
 FIG. 18 is a bottom view thereof;  
 FIG. 19 is a first side view thereof;  
 FIG. 20 is a second side view thereof;  
 FIG. 21 is a front view thereof;  
 FIG. 22 is a rear view thereof;  
 FIG. 23 is a forward upper perspective view thereof;  
 FIG. 24 is a rear upper perspective view thereof;  
 FIG. 25 is another top view thereof;

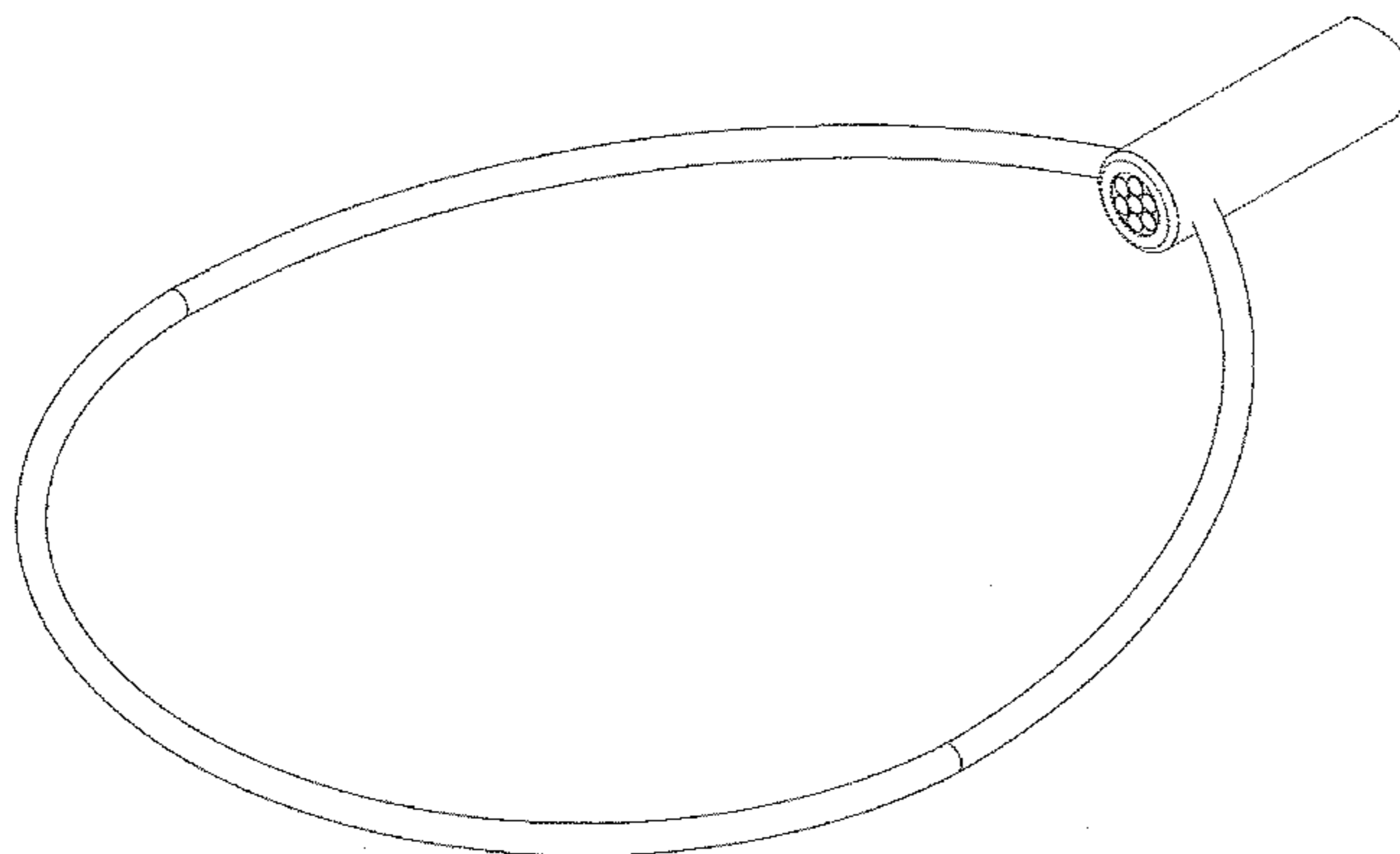

FIG. 26 is another bottom view thereof;  
FIG. 27 is another first side view thereof;  
FIG. 28 is another second side view thereof;  
FIG. 29 is another front view thereof;  
FIG. 30 is another rear view thereof;  
FIG. 31 is another forward upper perspective view thereof;  
FIG. 32 is a another rear upper perspective view thereof;  
FIG. 33 is a top view of a lighted net frame according to yet another embodiment of the disclosure;  
FIG. 34 is a bottom view thereof;  
FIG. 35 is a first side view thereof;  
FIG. 36 is a second side view thereof;  
FIG. 37 is a front view thereof;  
FIG. 38 is a rear view thereof;

FIG. 39 is a forward upper perspective view thereof;  
FIG. 40 is a rear upper perspective view thereof;  
FIG. 41 is another top view thereof;  
FIG. 42 is another bottom view thereof;  
FIG. 43 is another first side view thereof;  
FIG. 44 is another second side view thereof;  
FIG. 45 is another front view thereof;  
FIG. 46 is another rear view thereof;  
FIG. 47 is another forward upper perspective view thereof;  
and,  
FIG. 48 is another rear upper perspective view thereof.  
The broken lines are for illustrative purposes only and form no part of the claimed design.

**1 Claim, 36 Drawing Sheets**

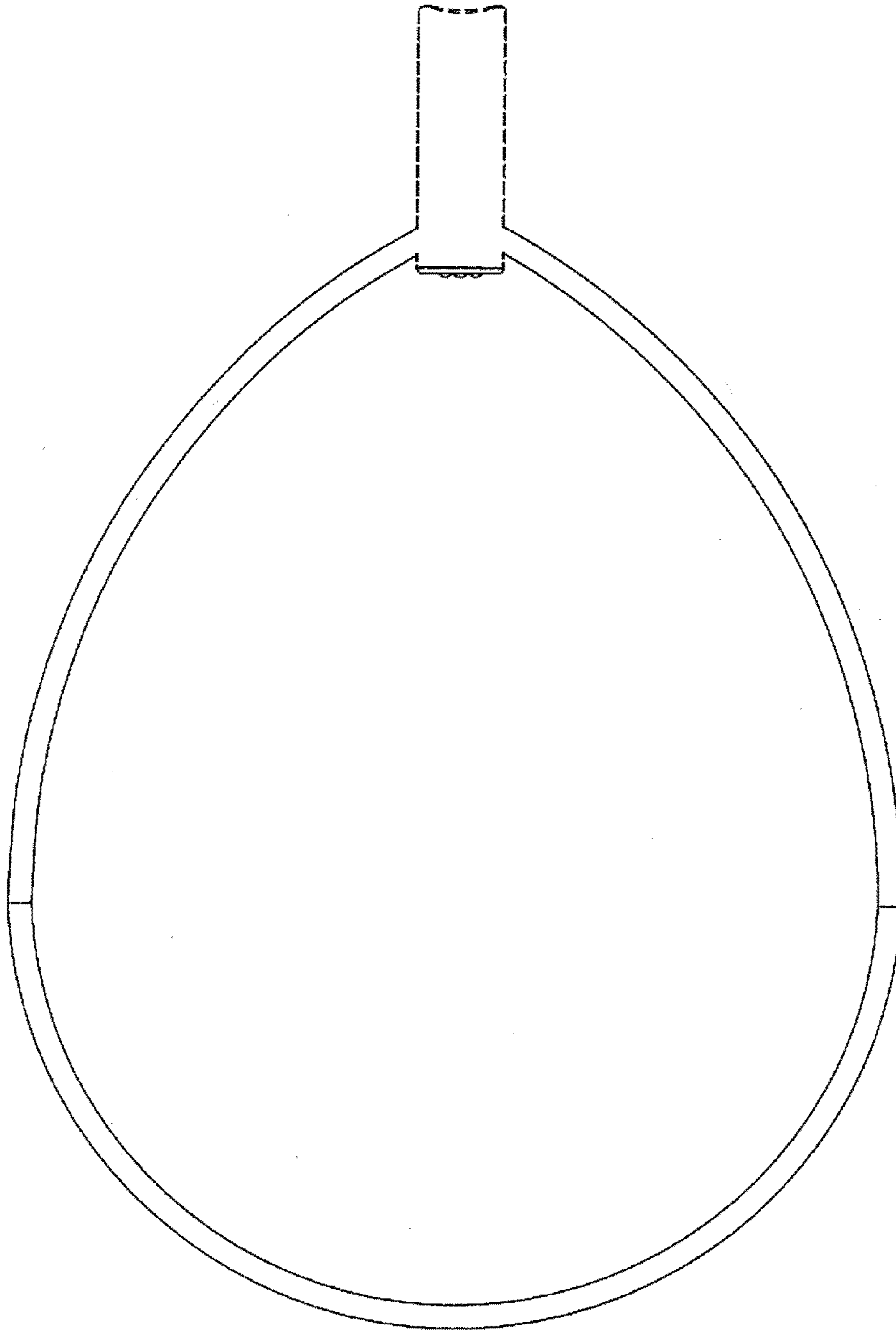

FIG. 1

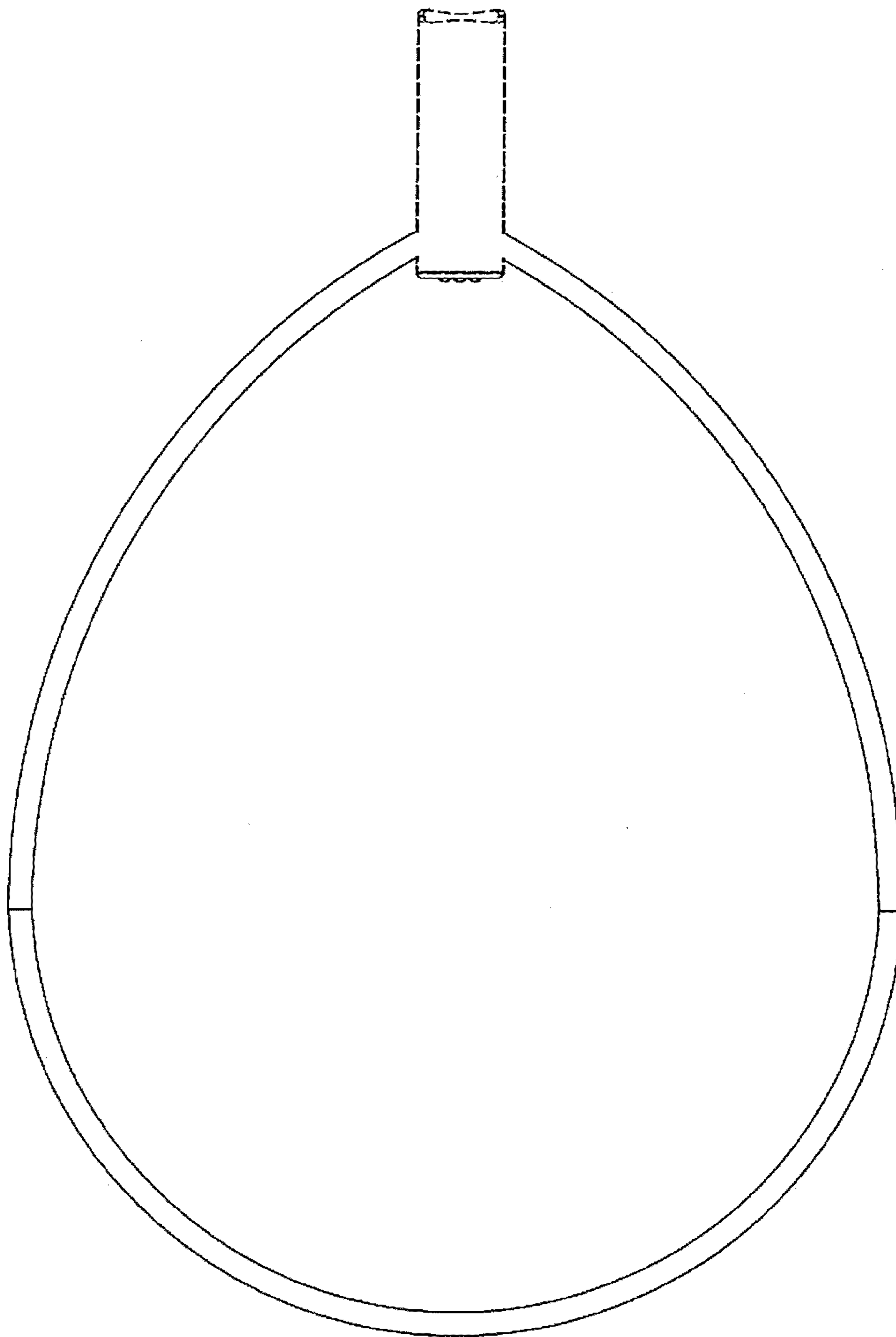

FIG. 2

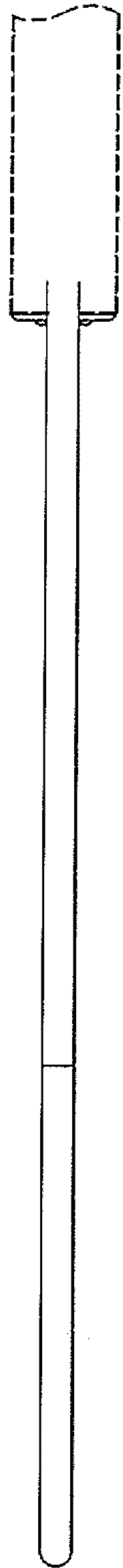

FIG. 3

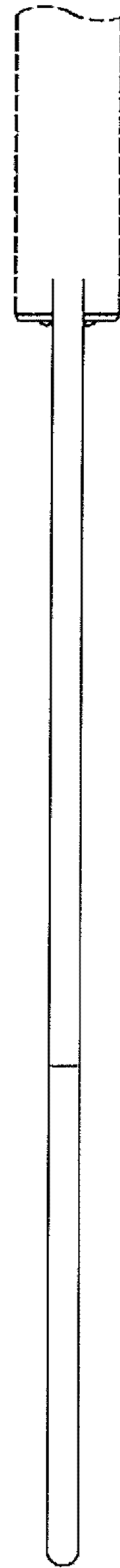

FIG. 4

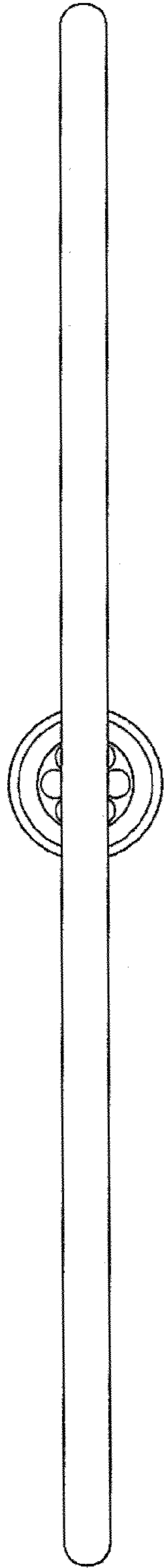

FIG. 5

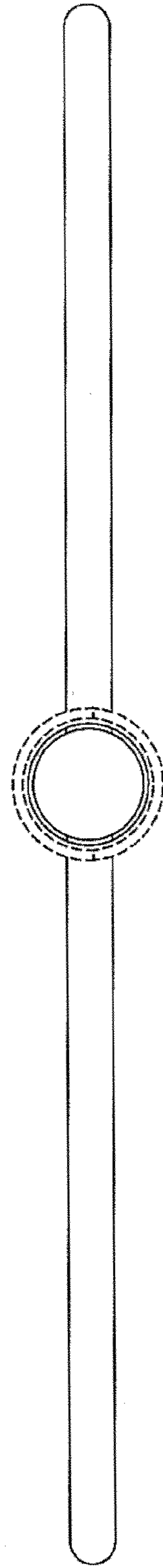

FIG. 6

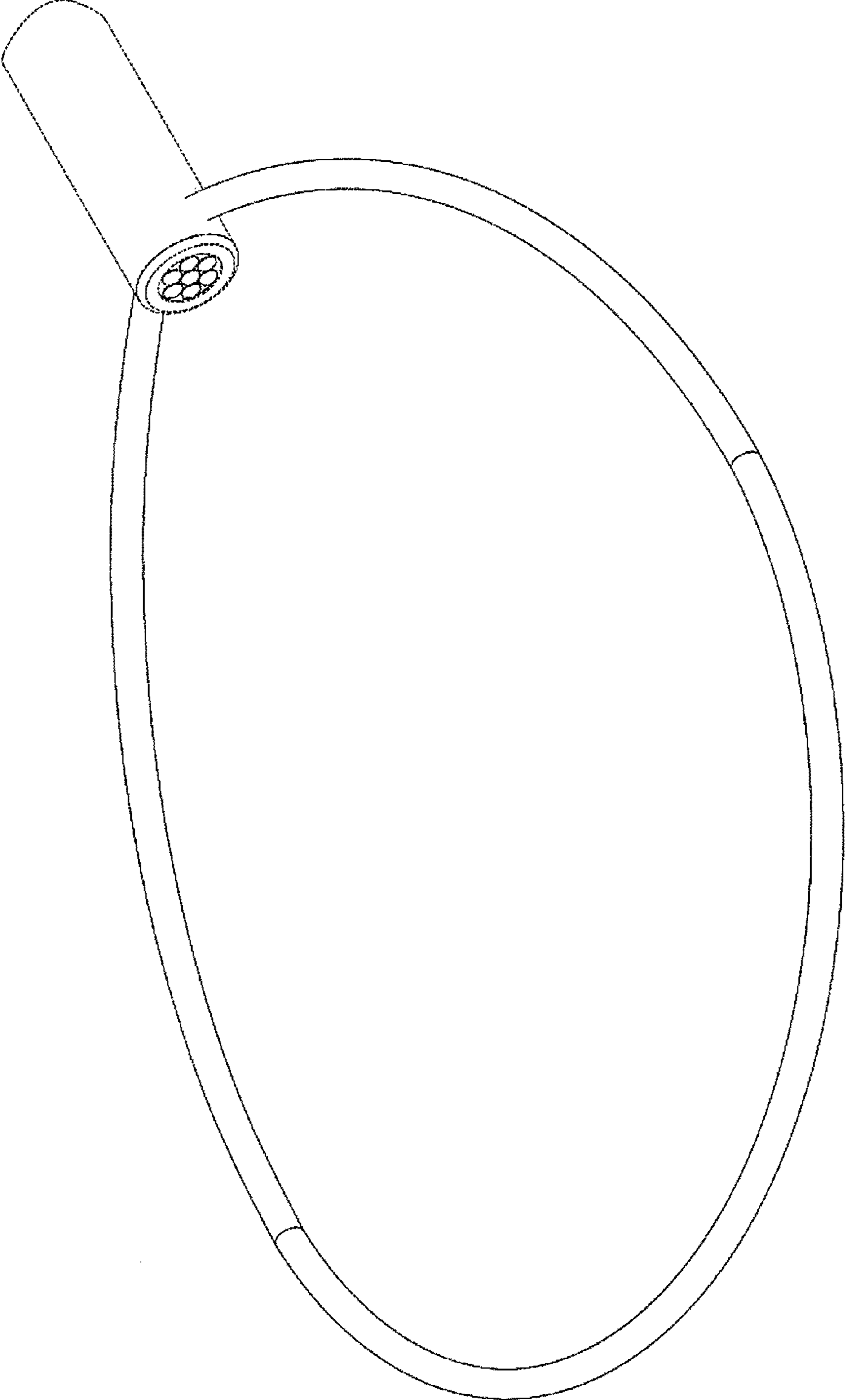

FIG. 7

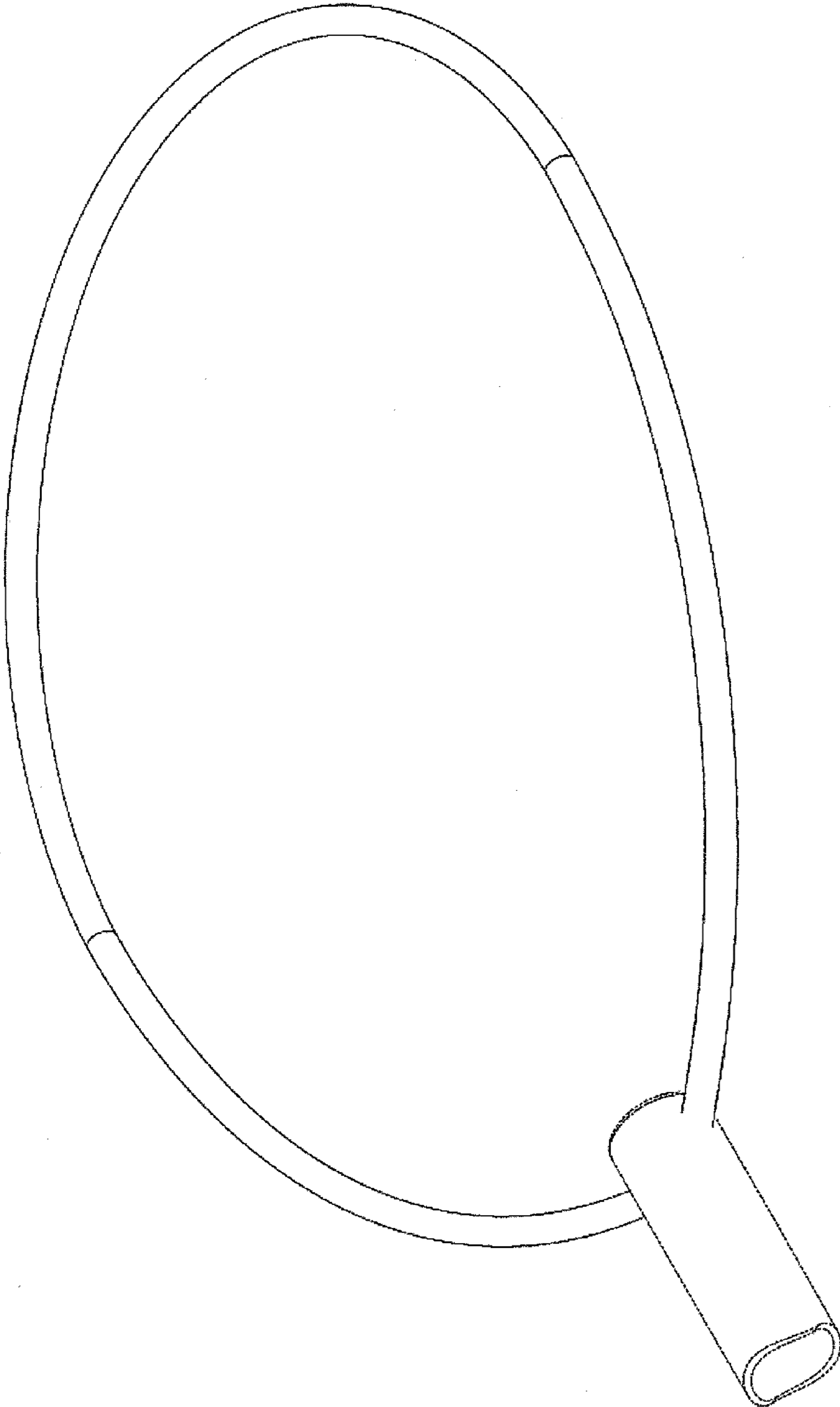

FIG. 8



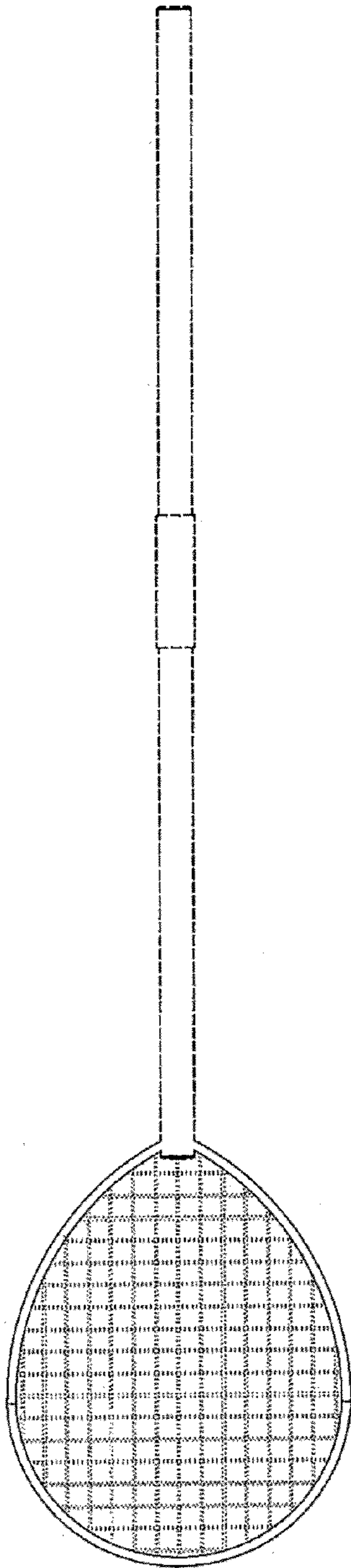

FIG. 9

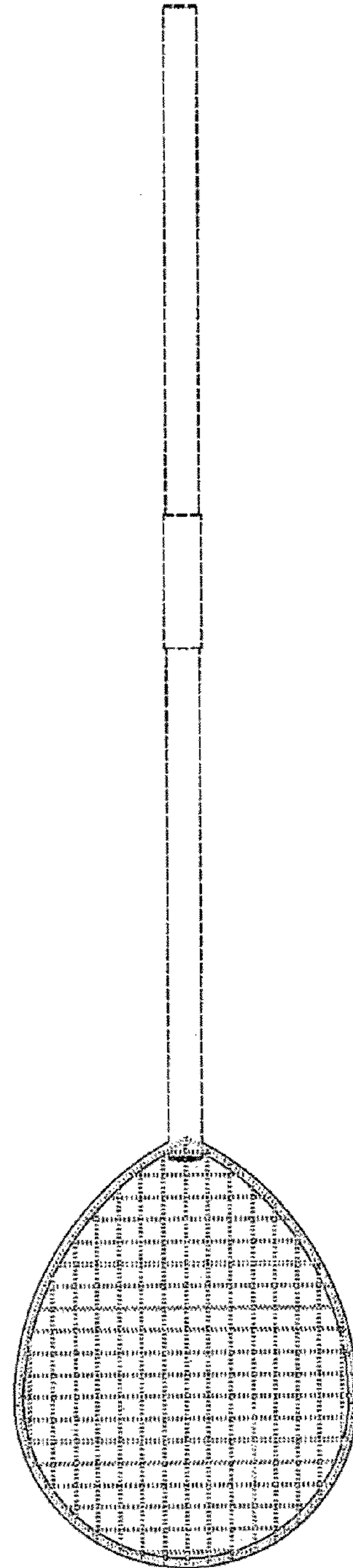

FIG. 10



FIG. 11

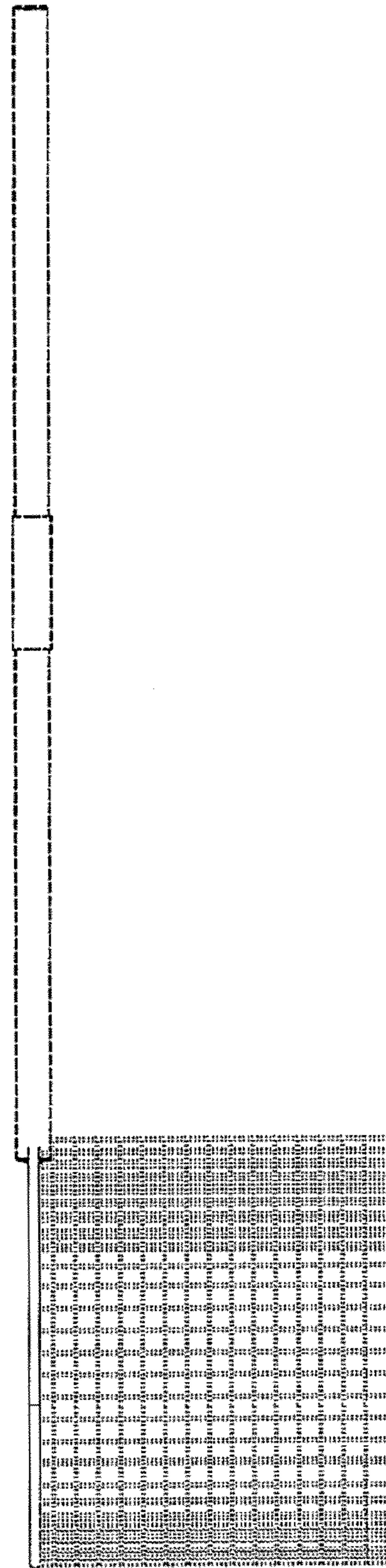

FIG. 12

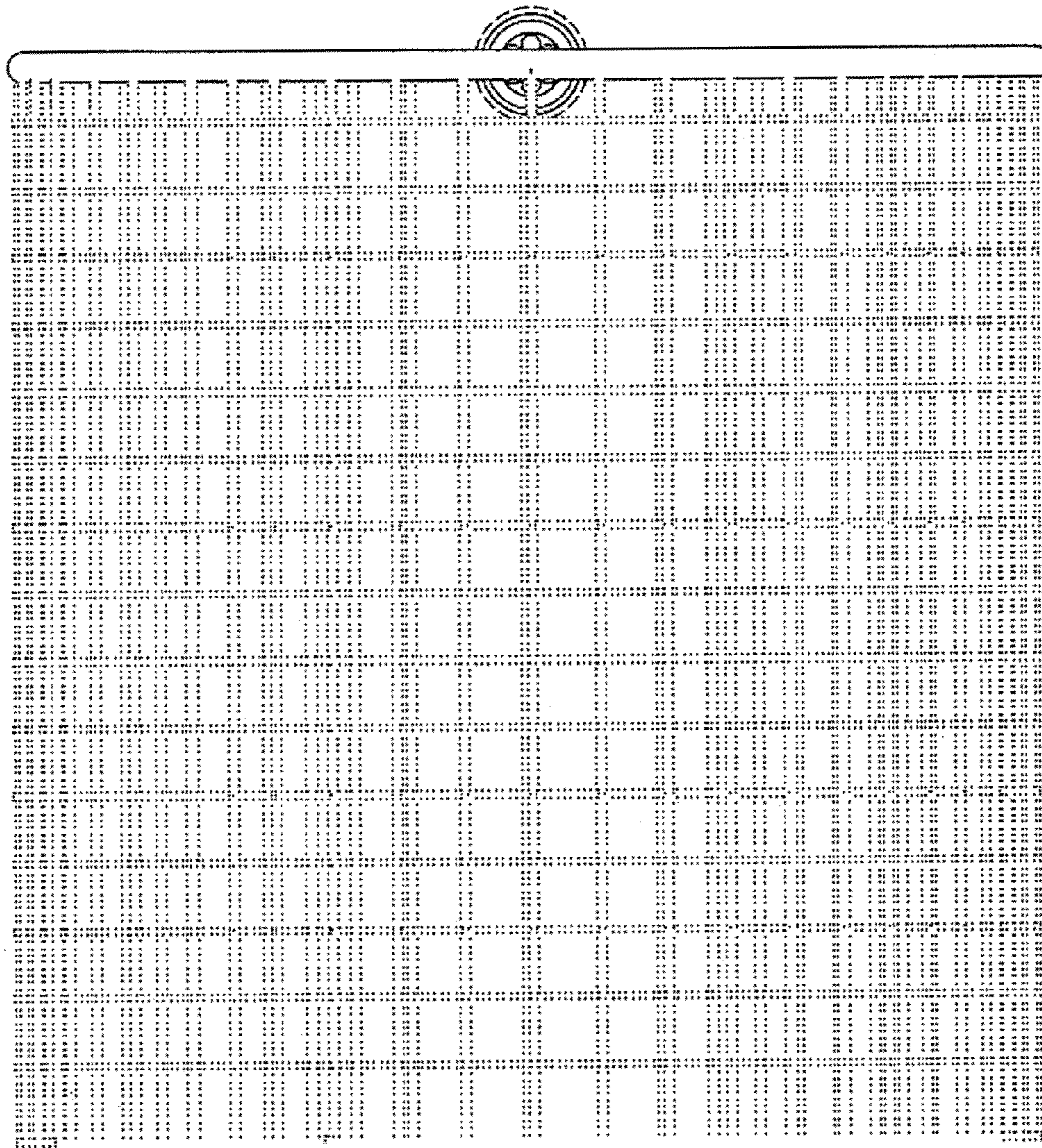

FIG. 13

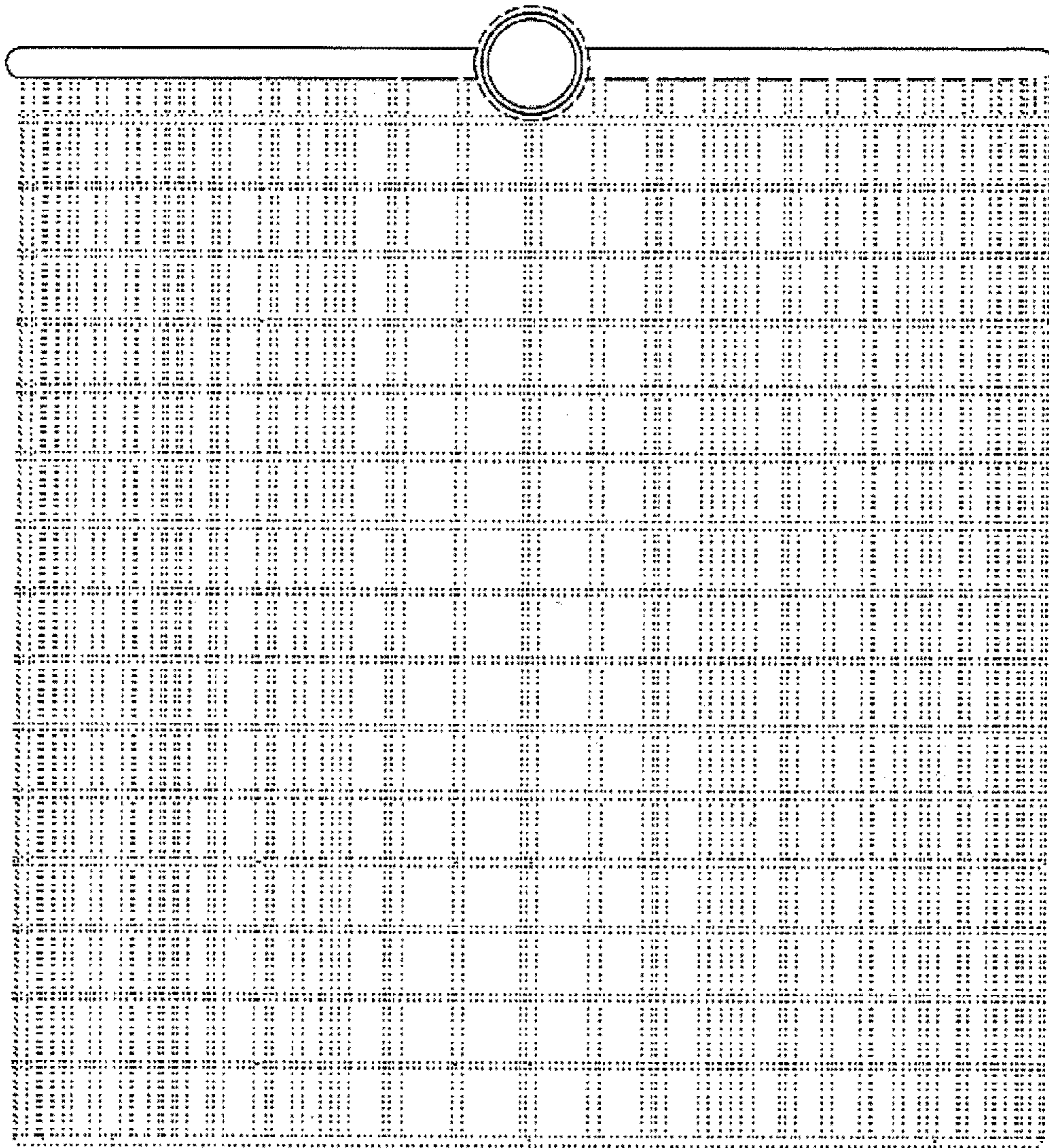

FIG. 14

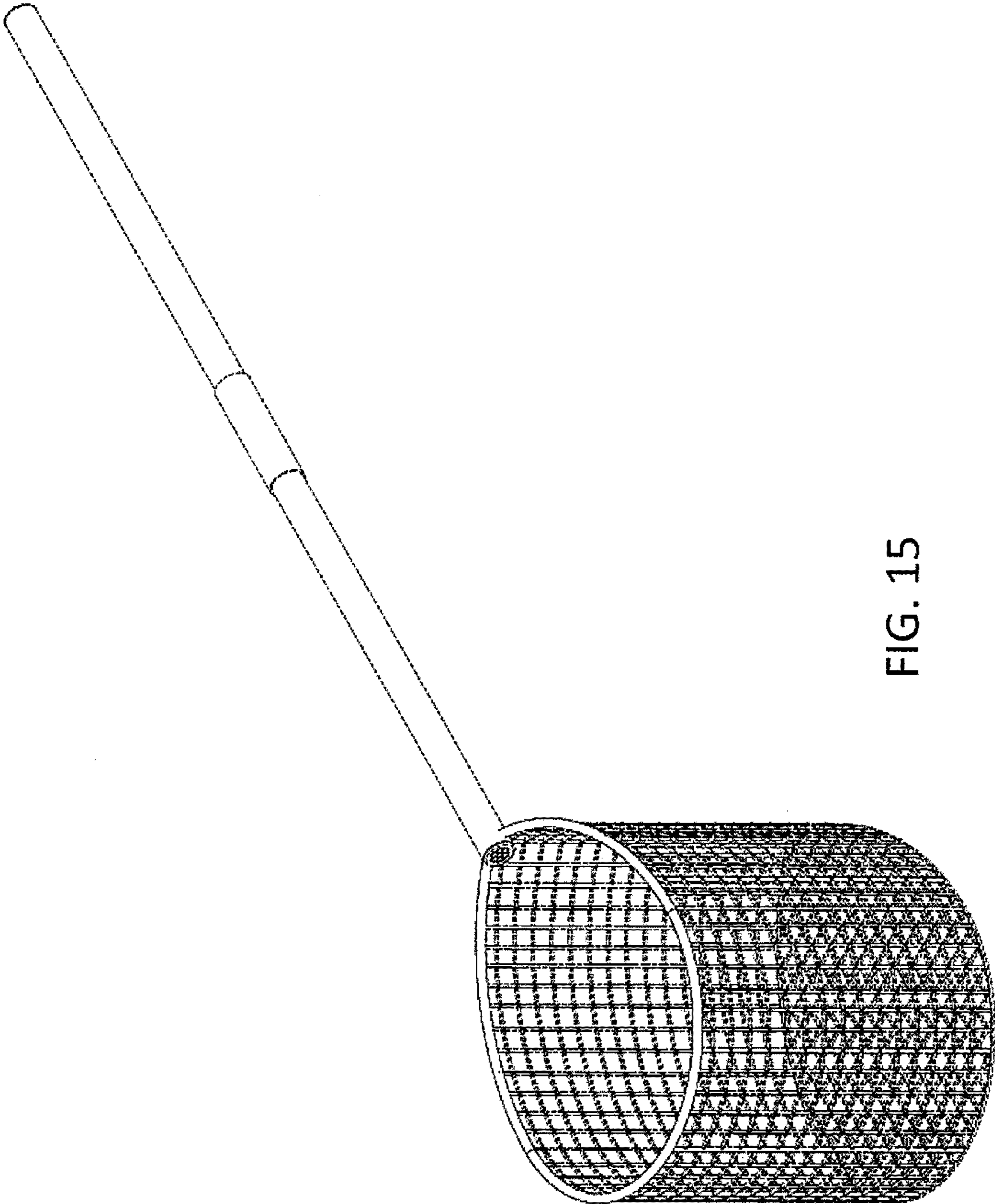

FIG. 15

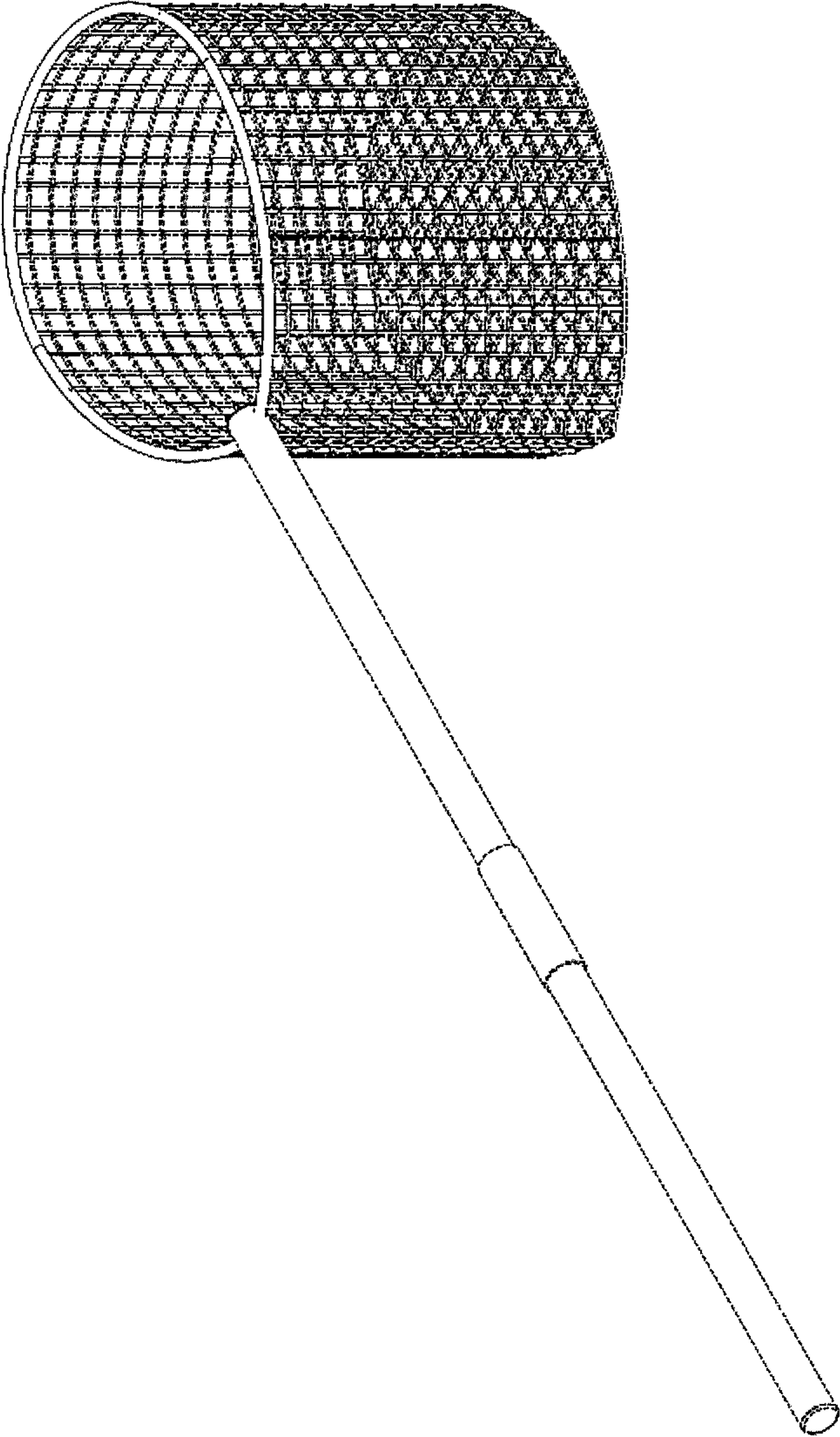

FIG. 16

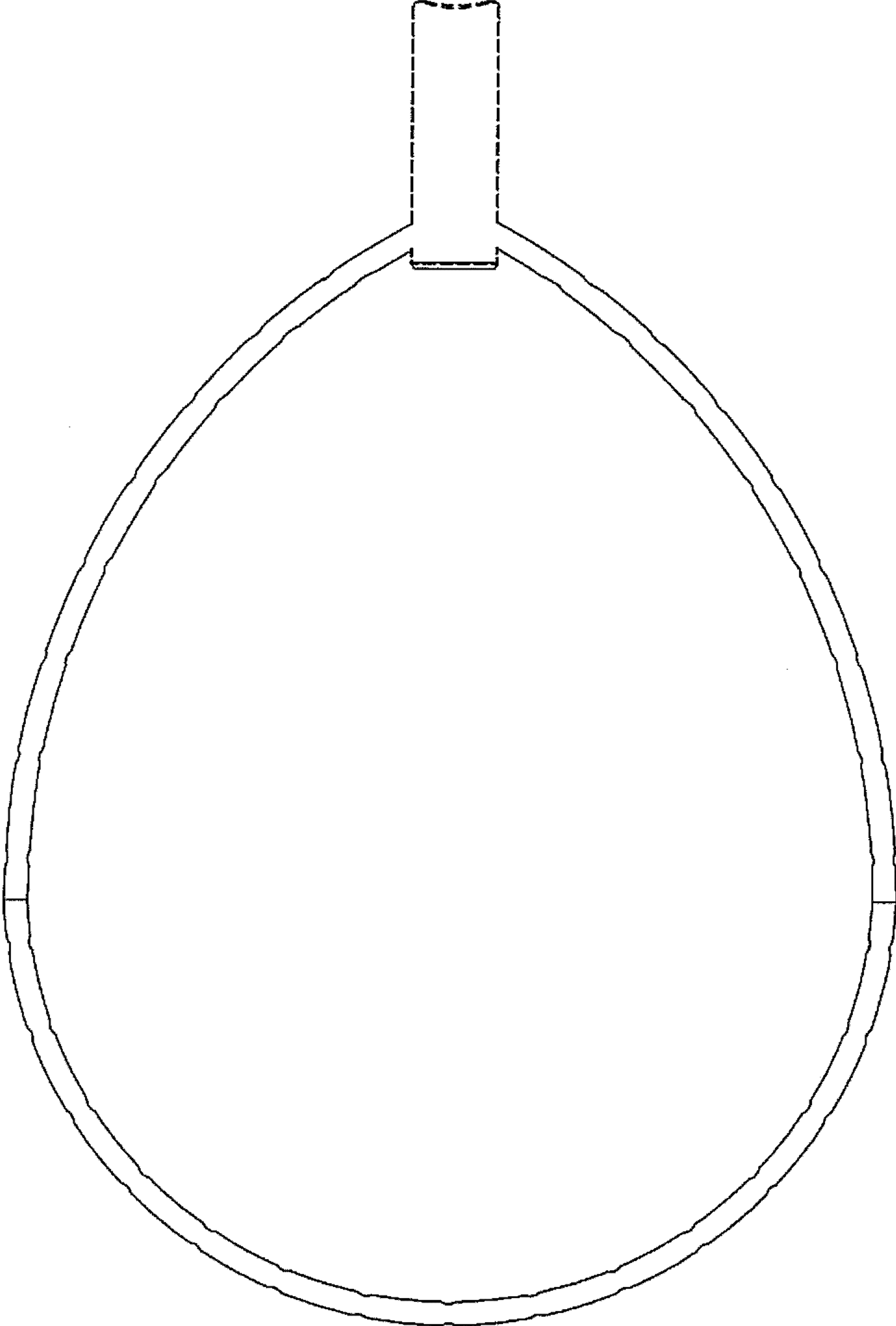

FIG. 17

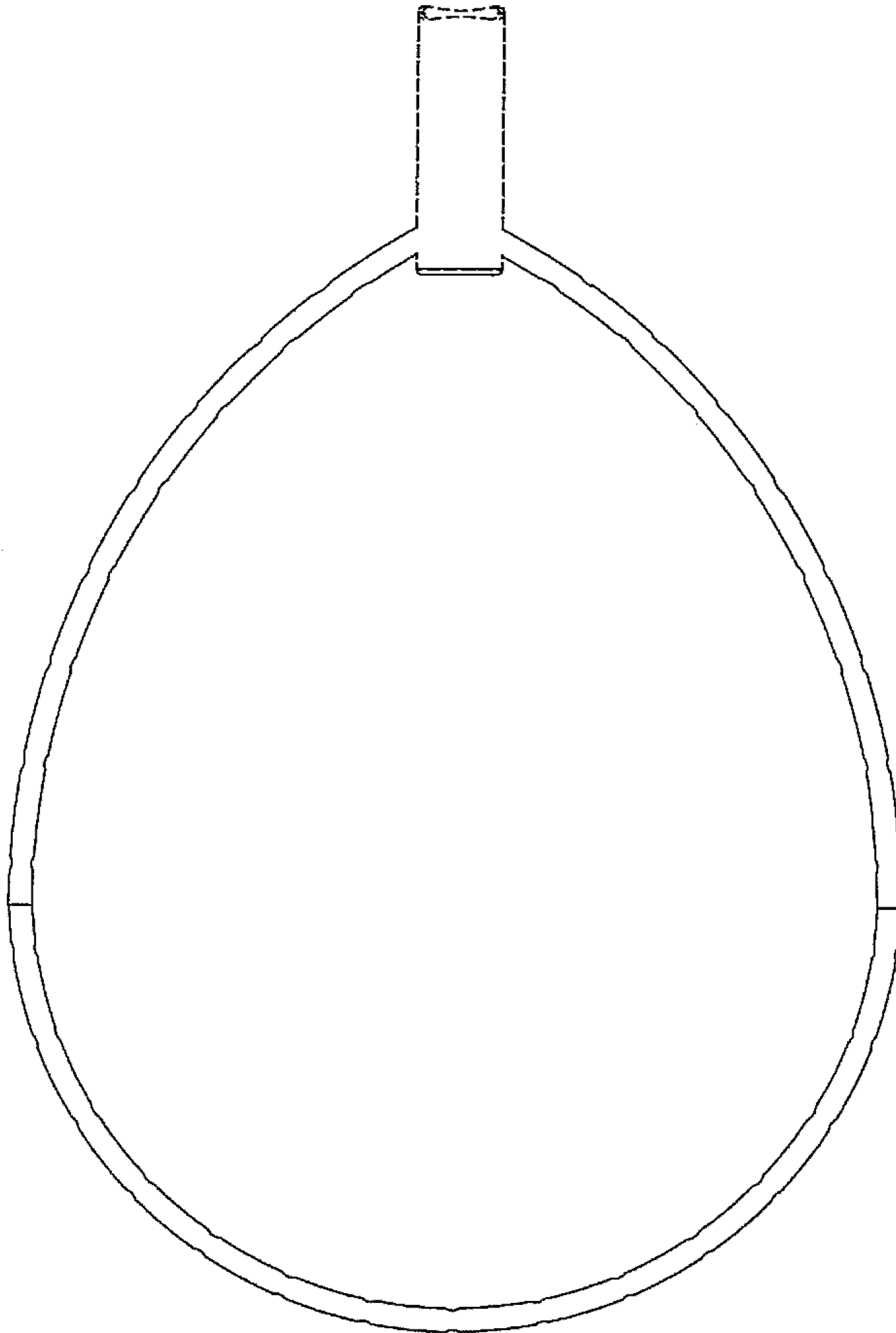

FIG. 18



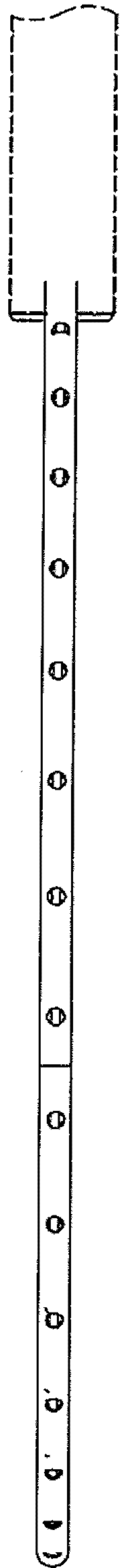

FIG. 19

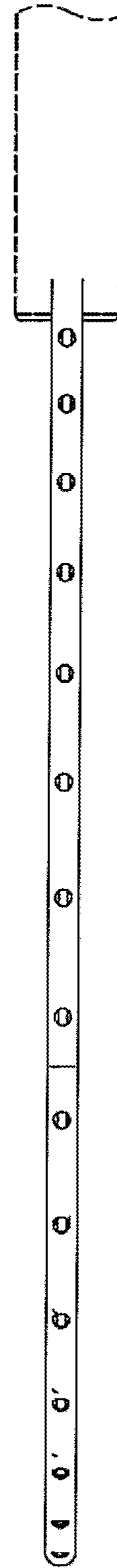

FIG. 20

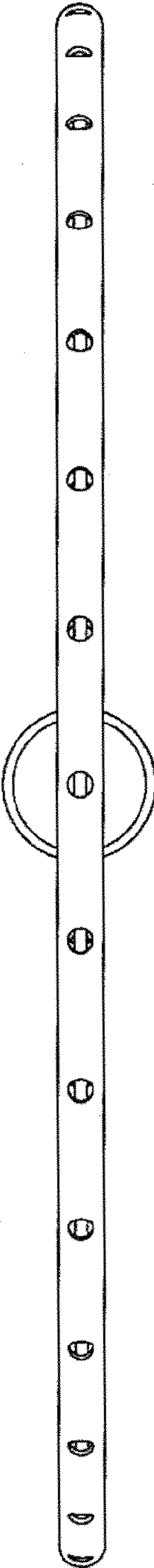

FIG. 21

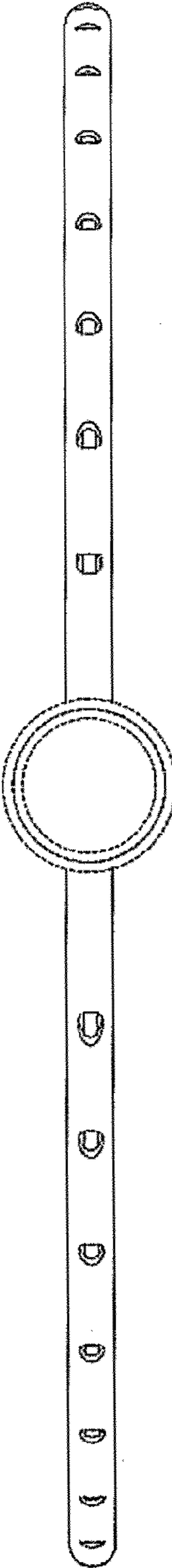

FIG. 22

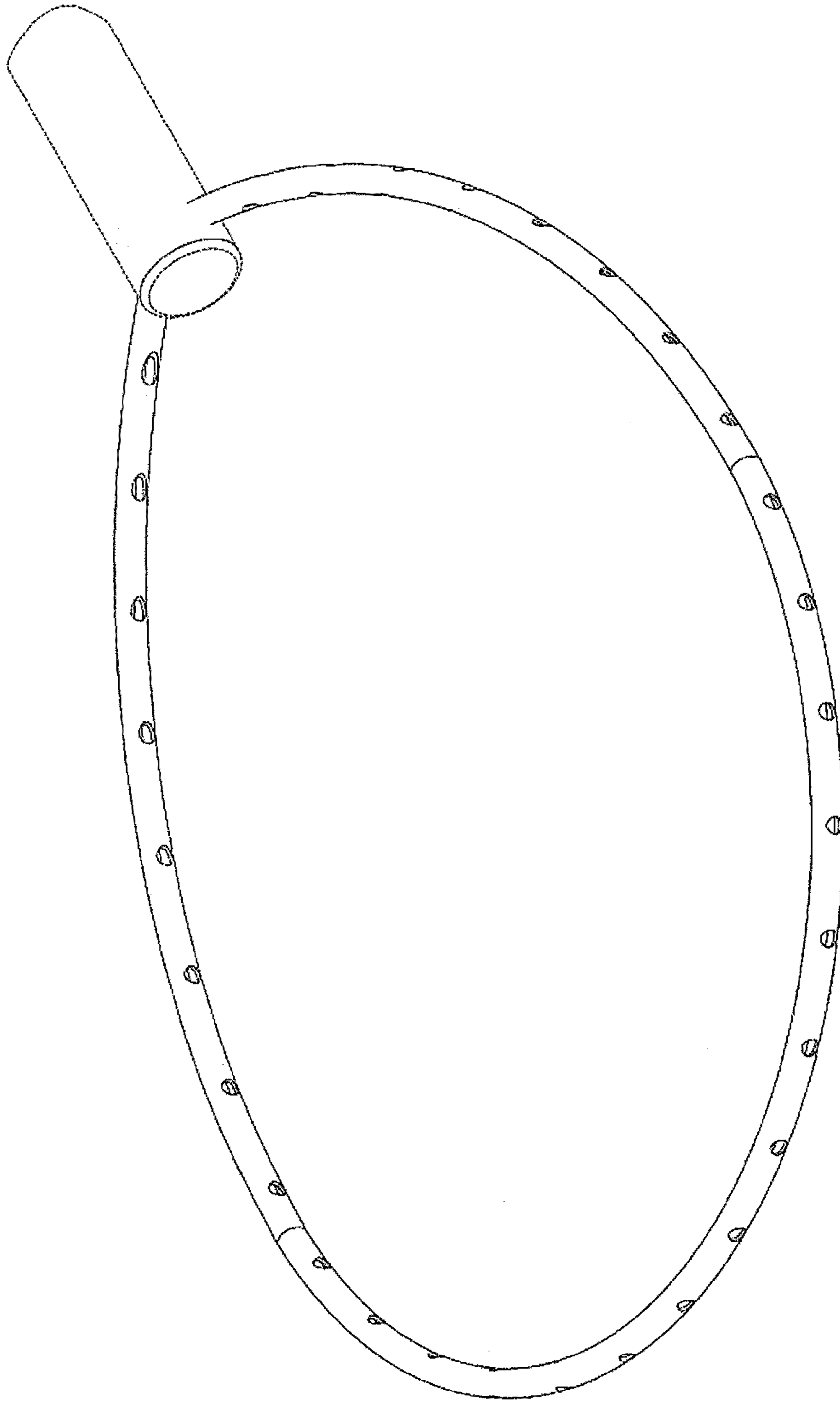

FIG. 23

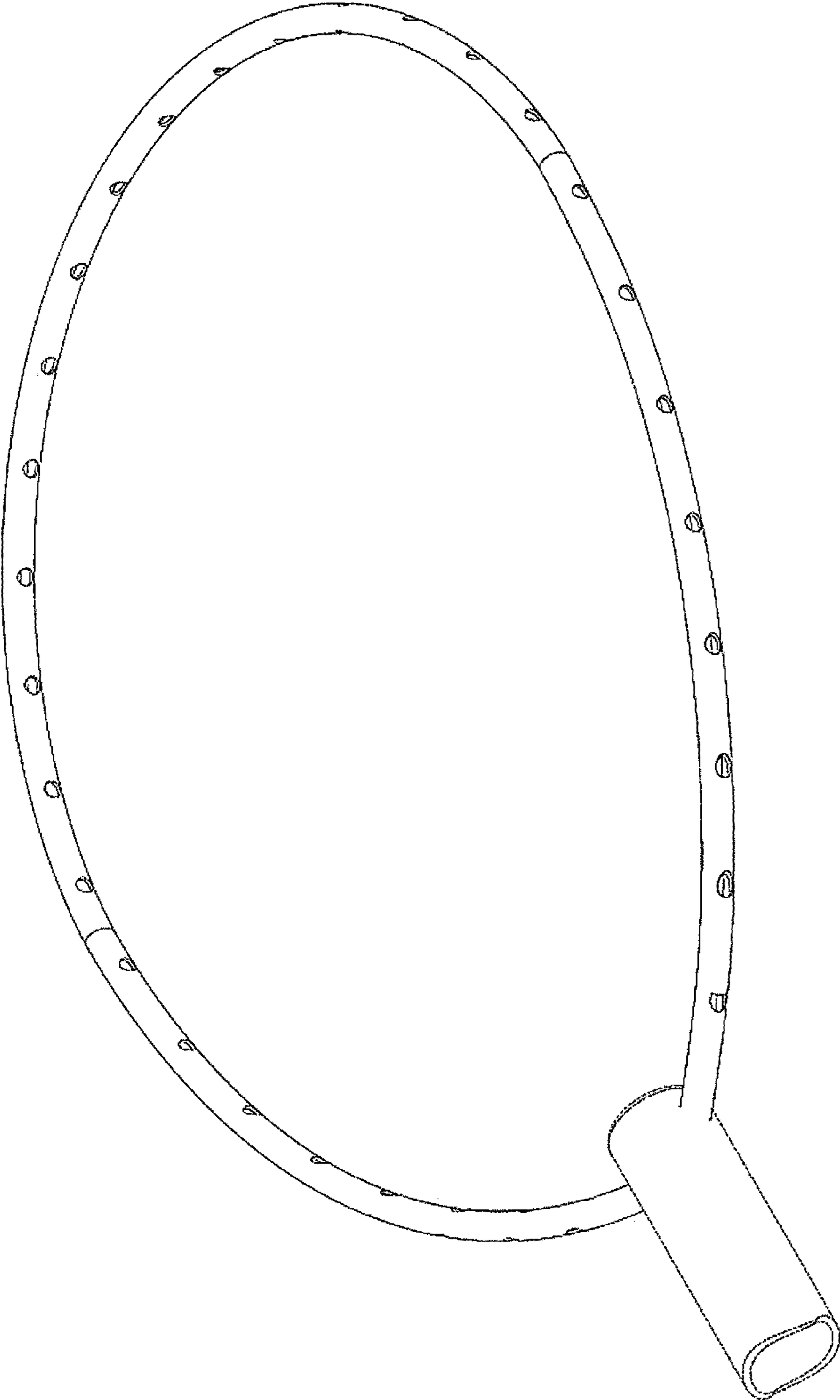

FIG. 24

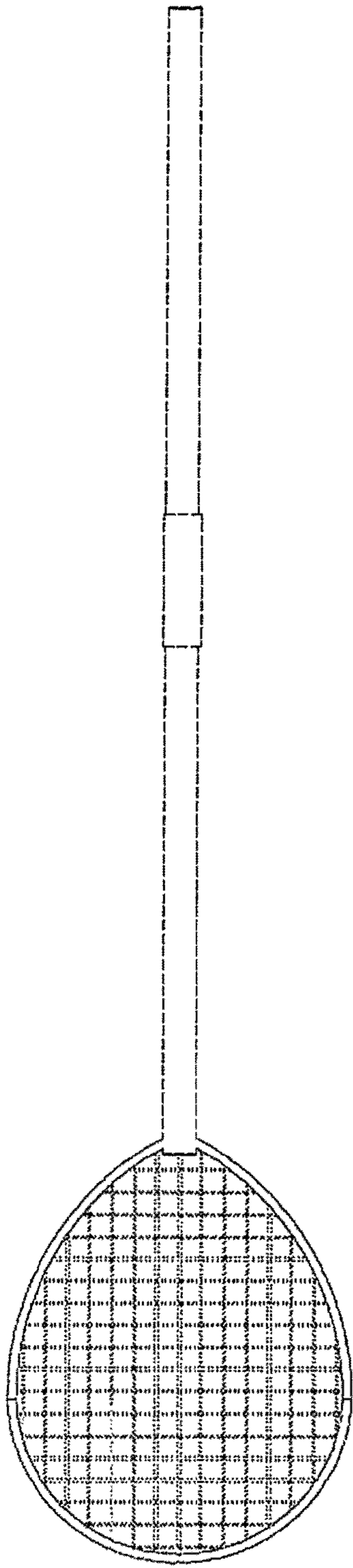

FIG. 25

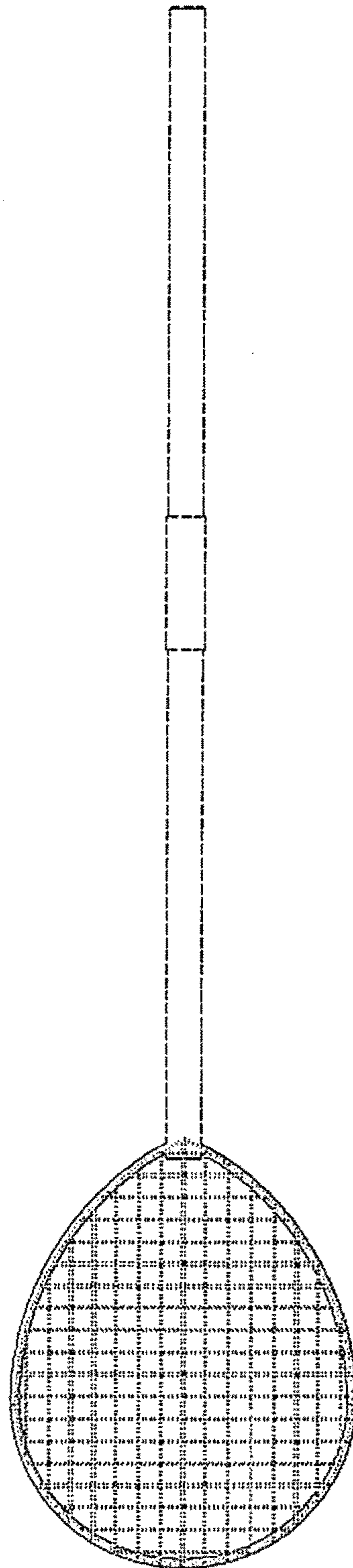

FIG. 26

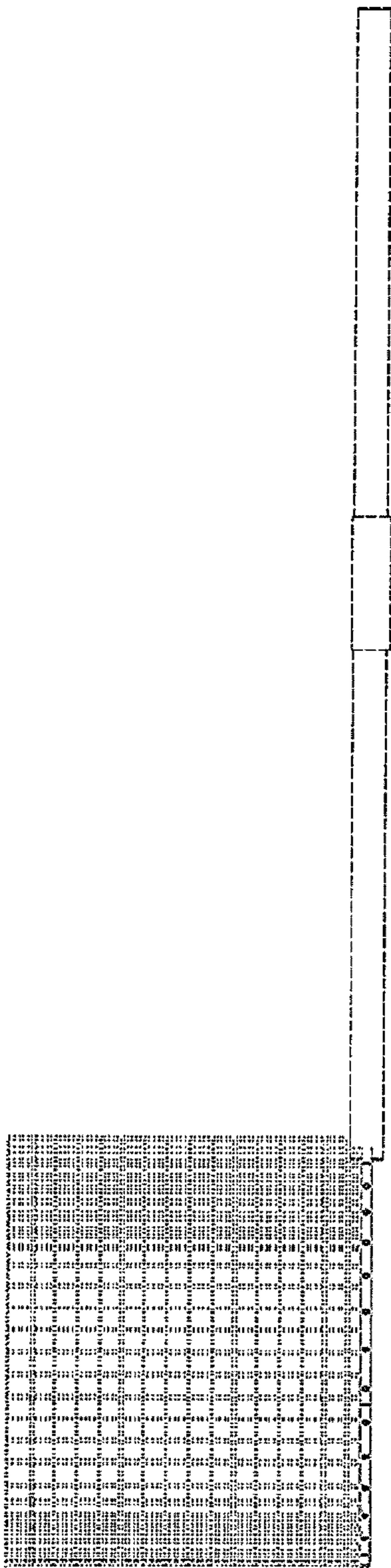

FIG. 27

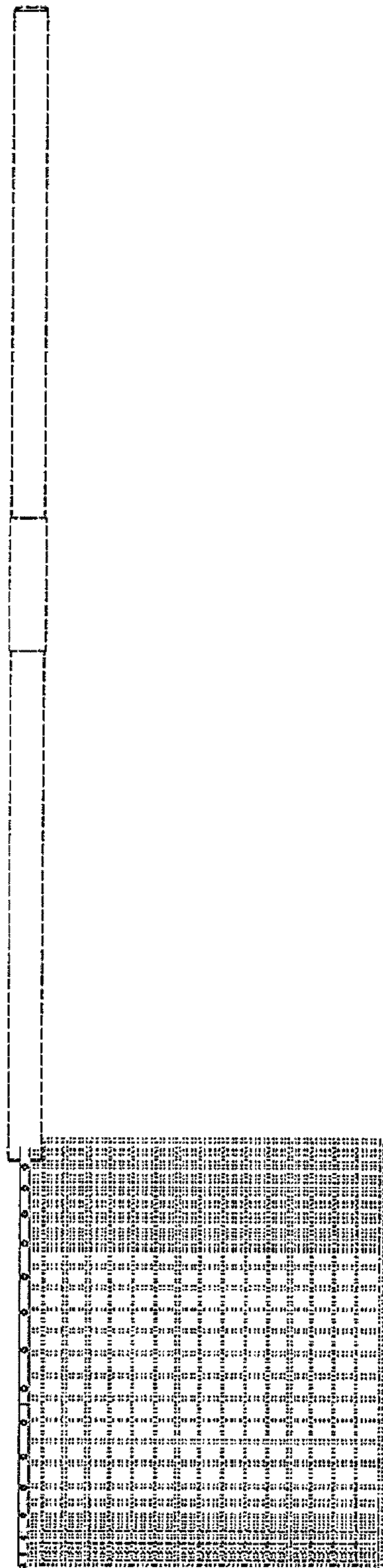

FIG. 28

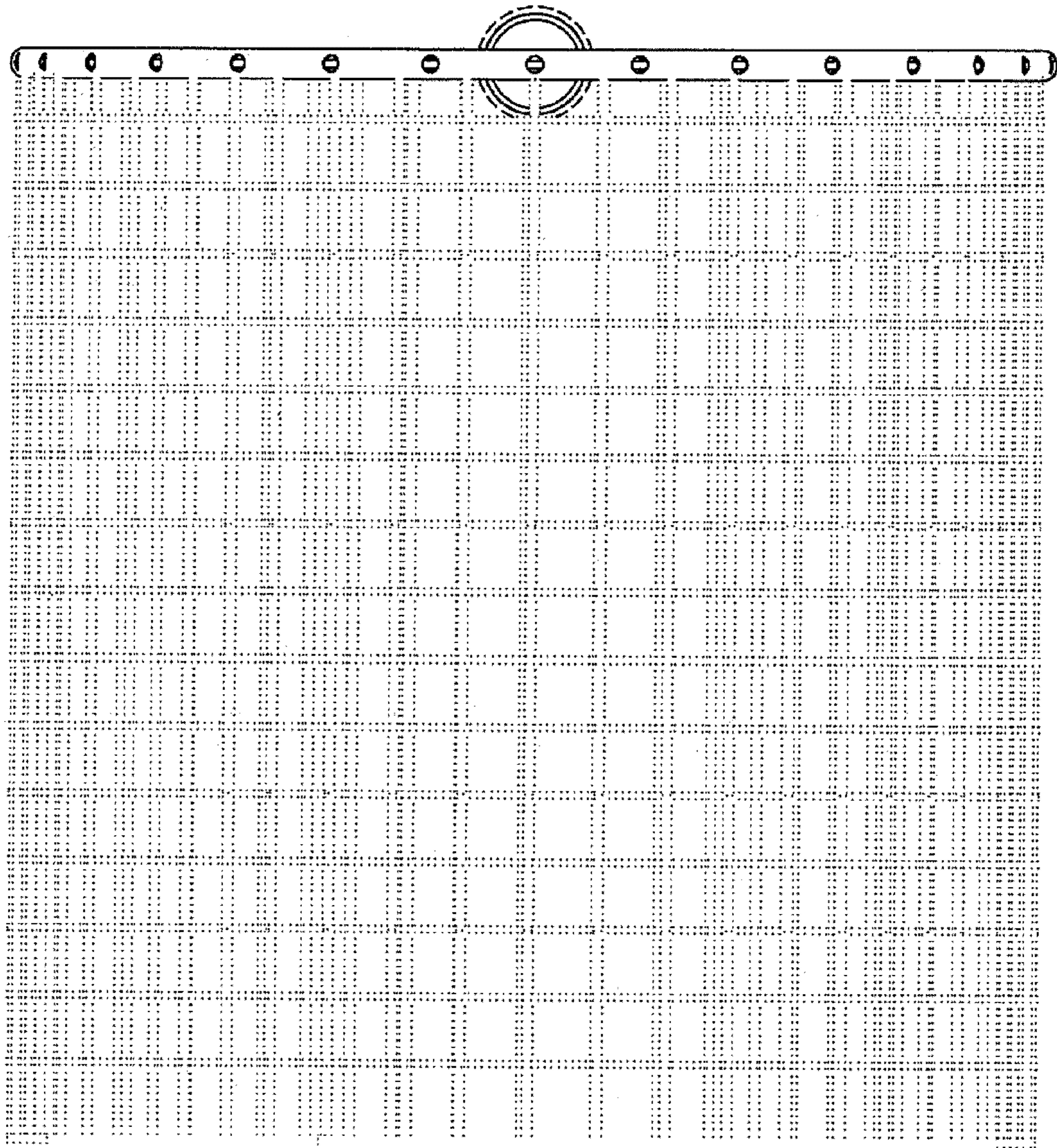

FIG. 29

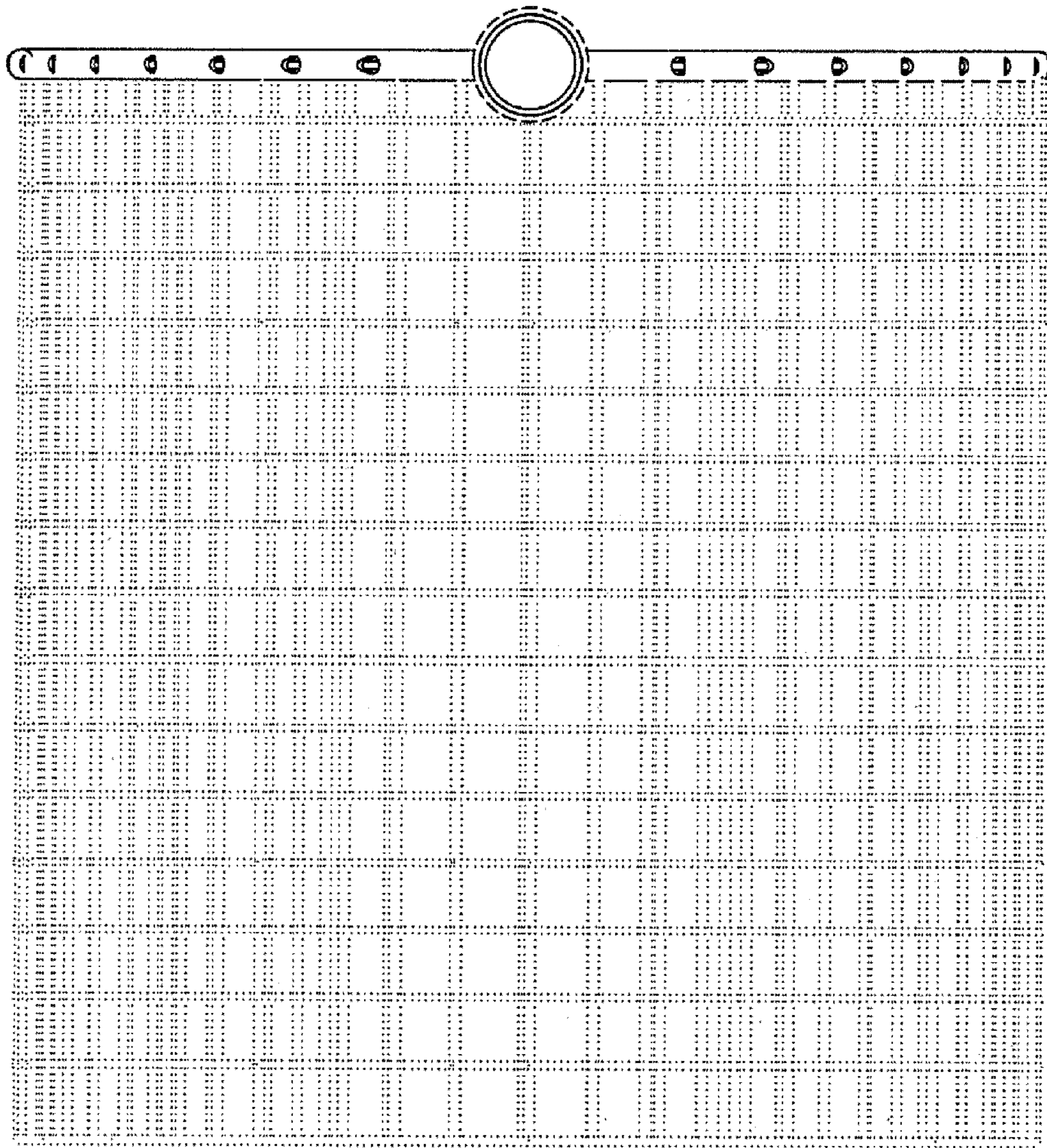

FIG. 30



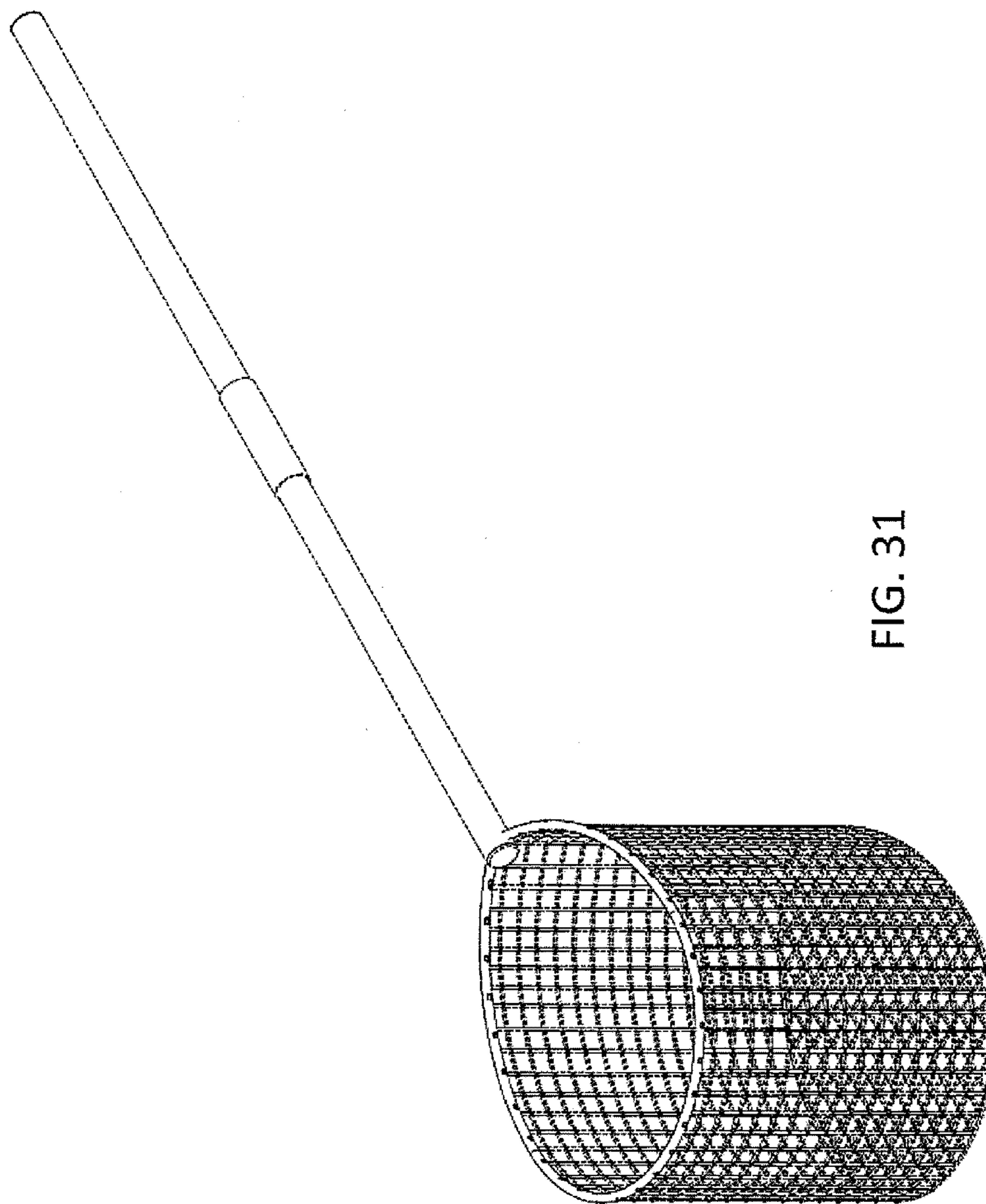

FIG. 31

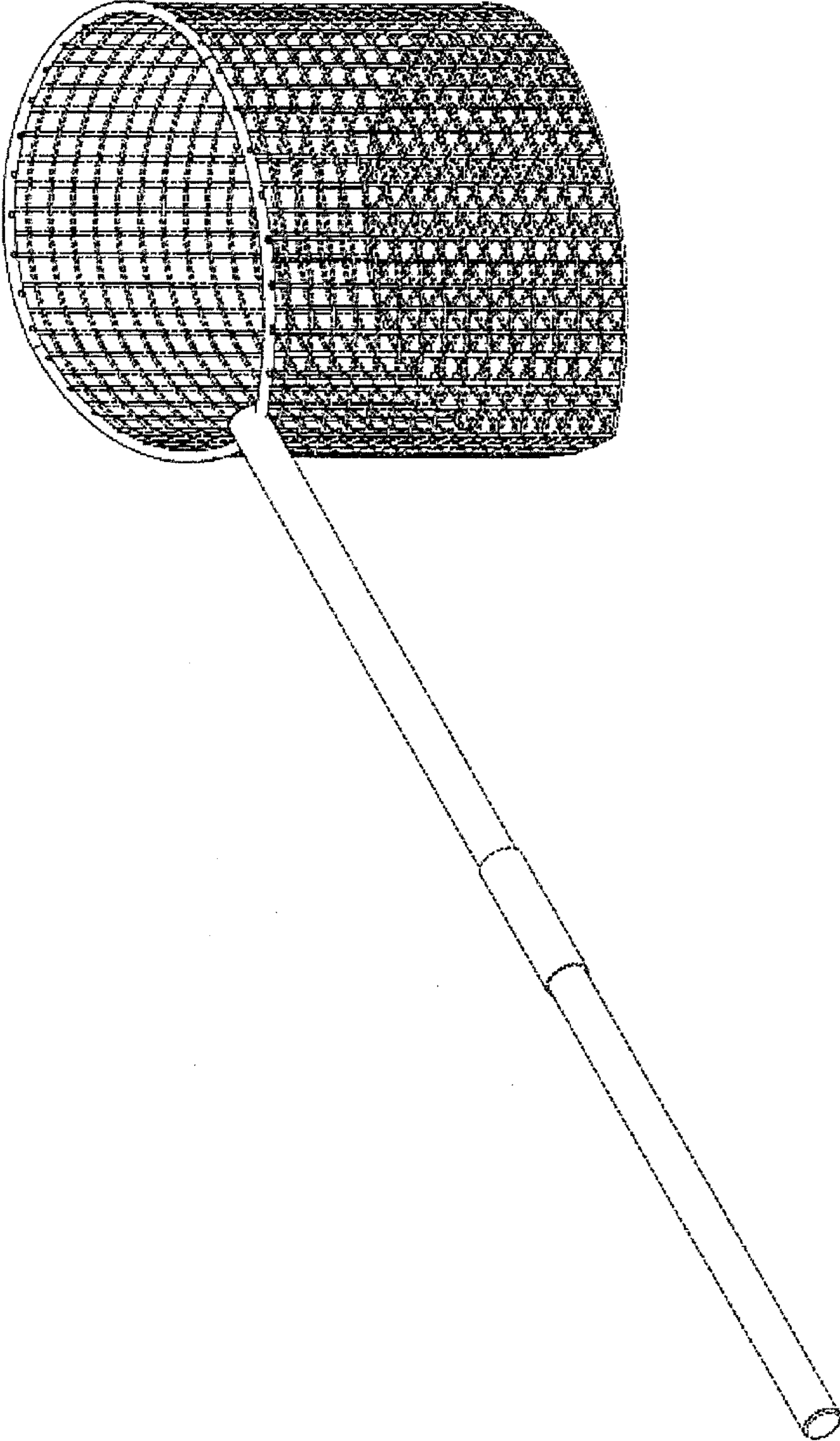

FIG. 32

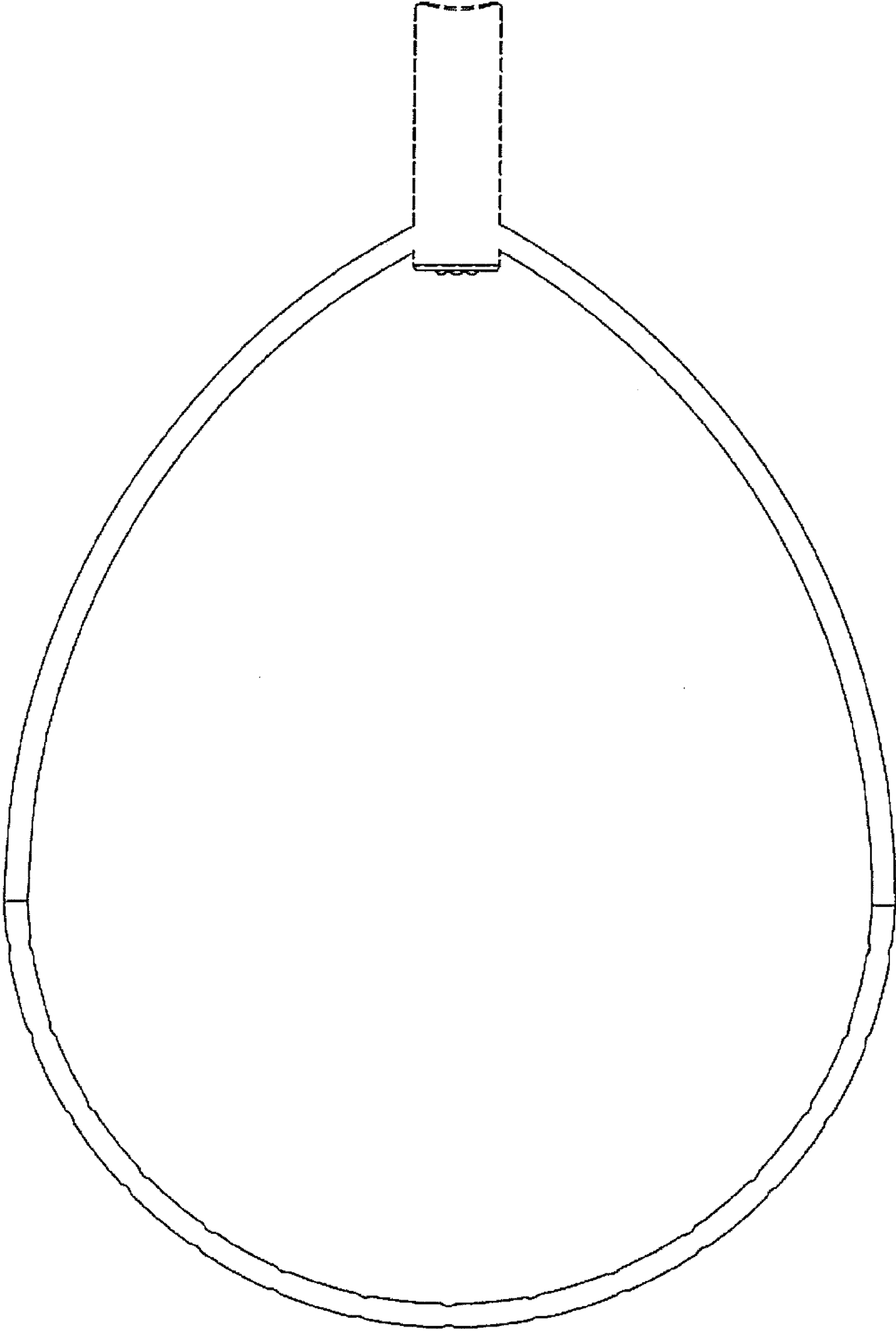

FIG. 33

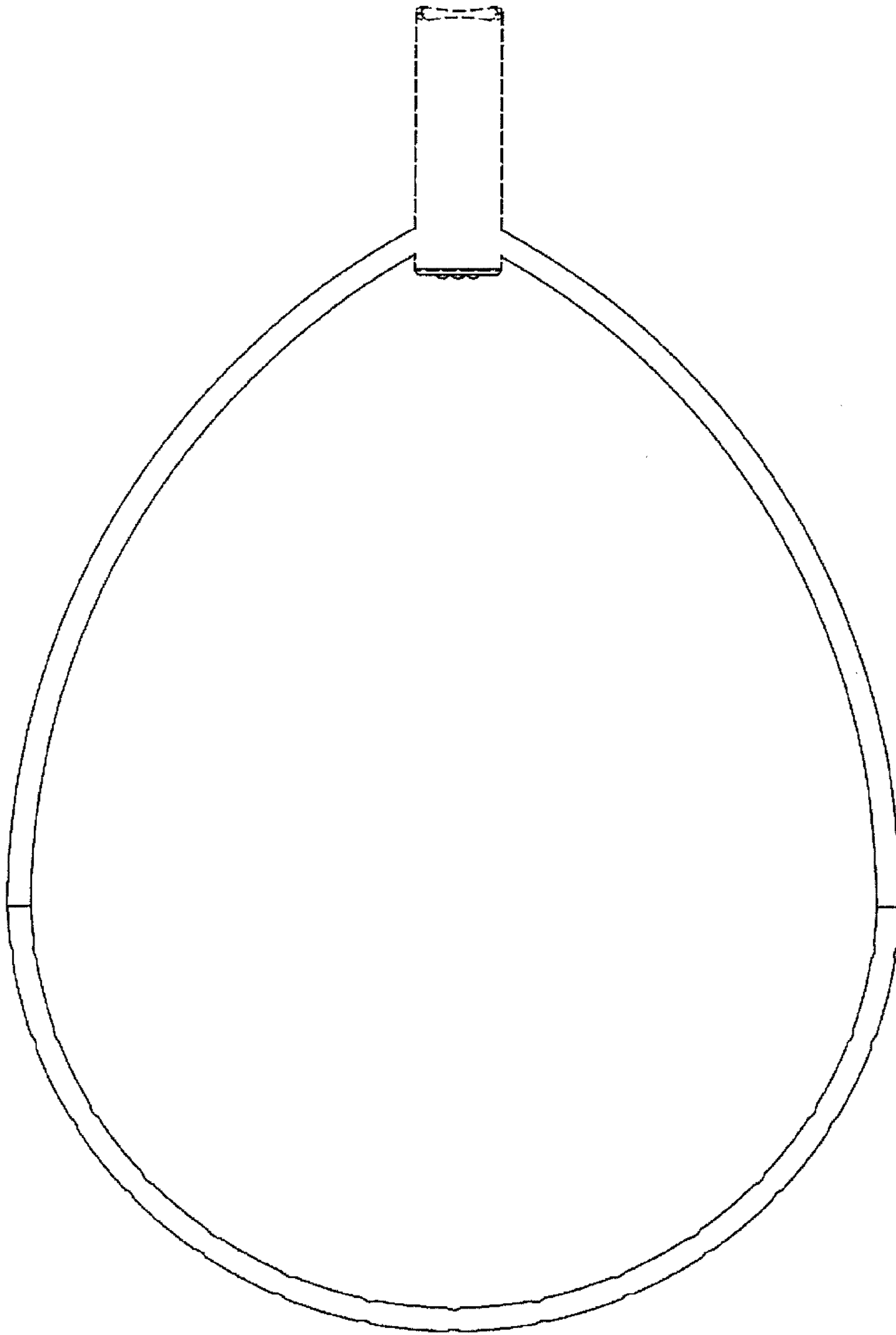

FIG. 34

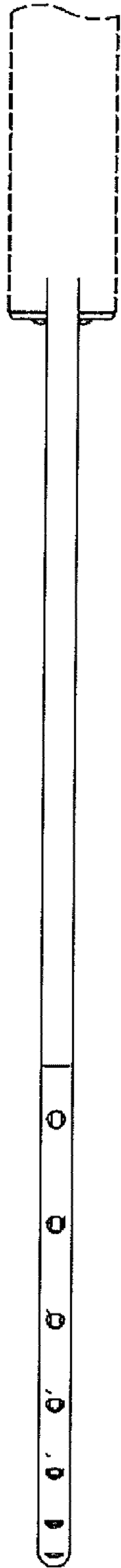

FIG. 35

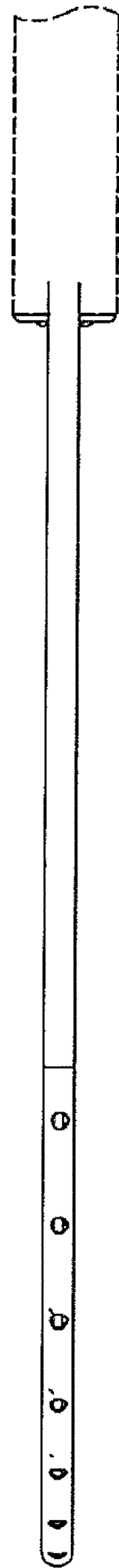

FIG. 36

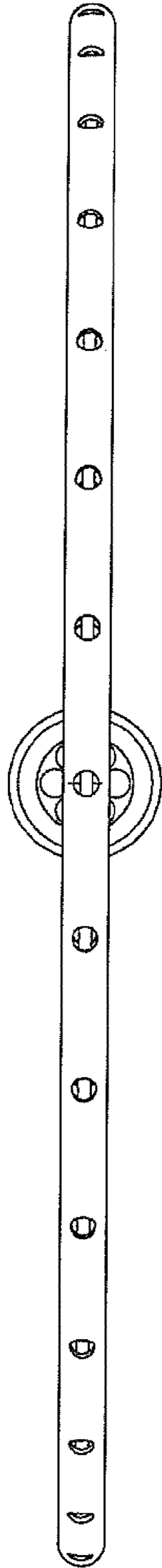

FIG. 37

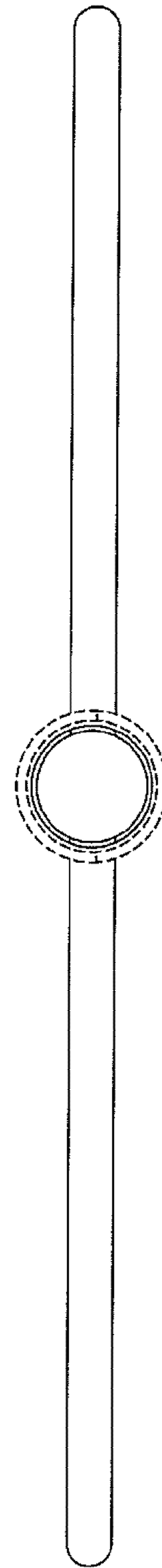

FIG. 38

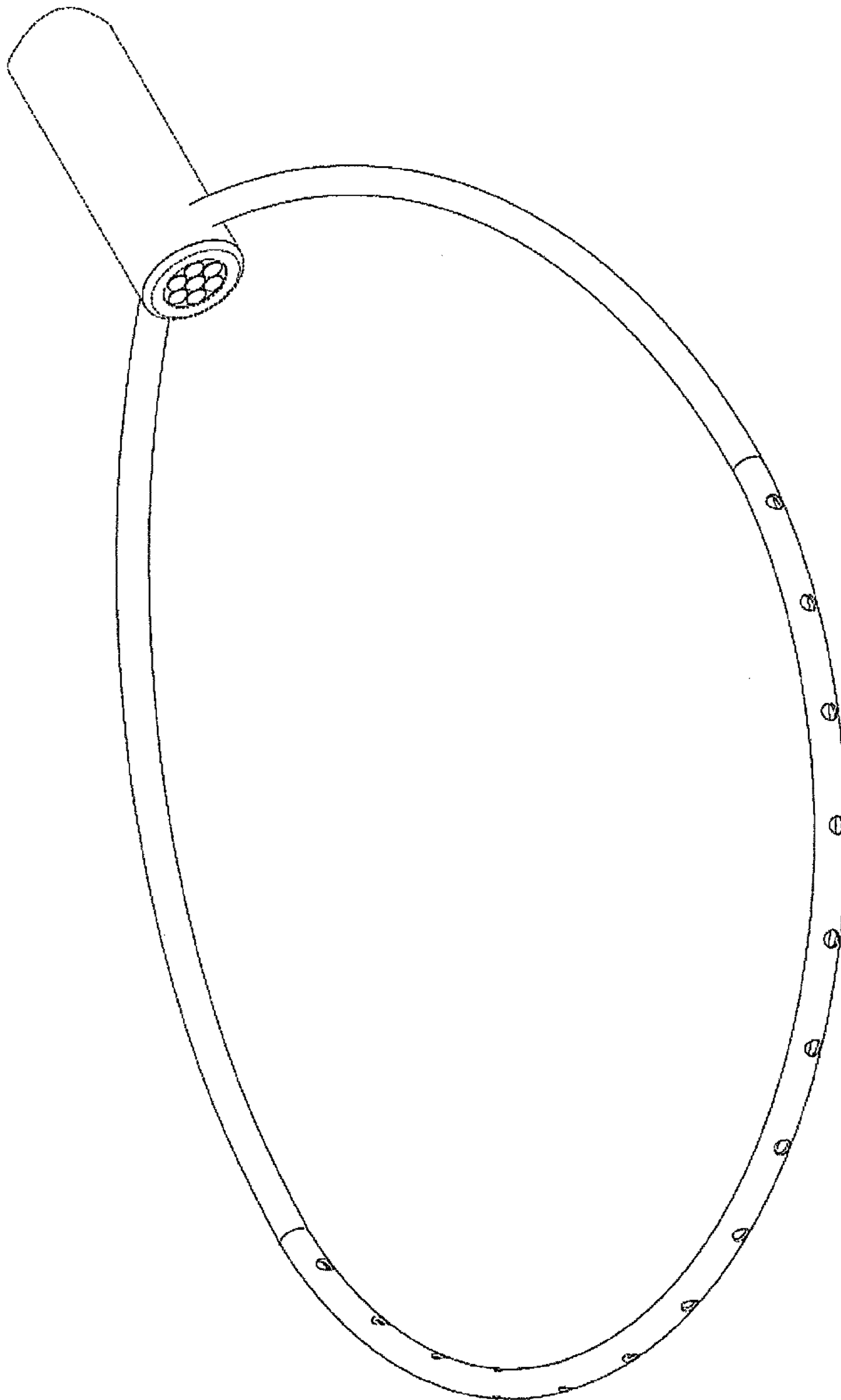

FIG. 39

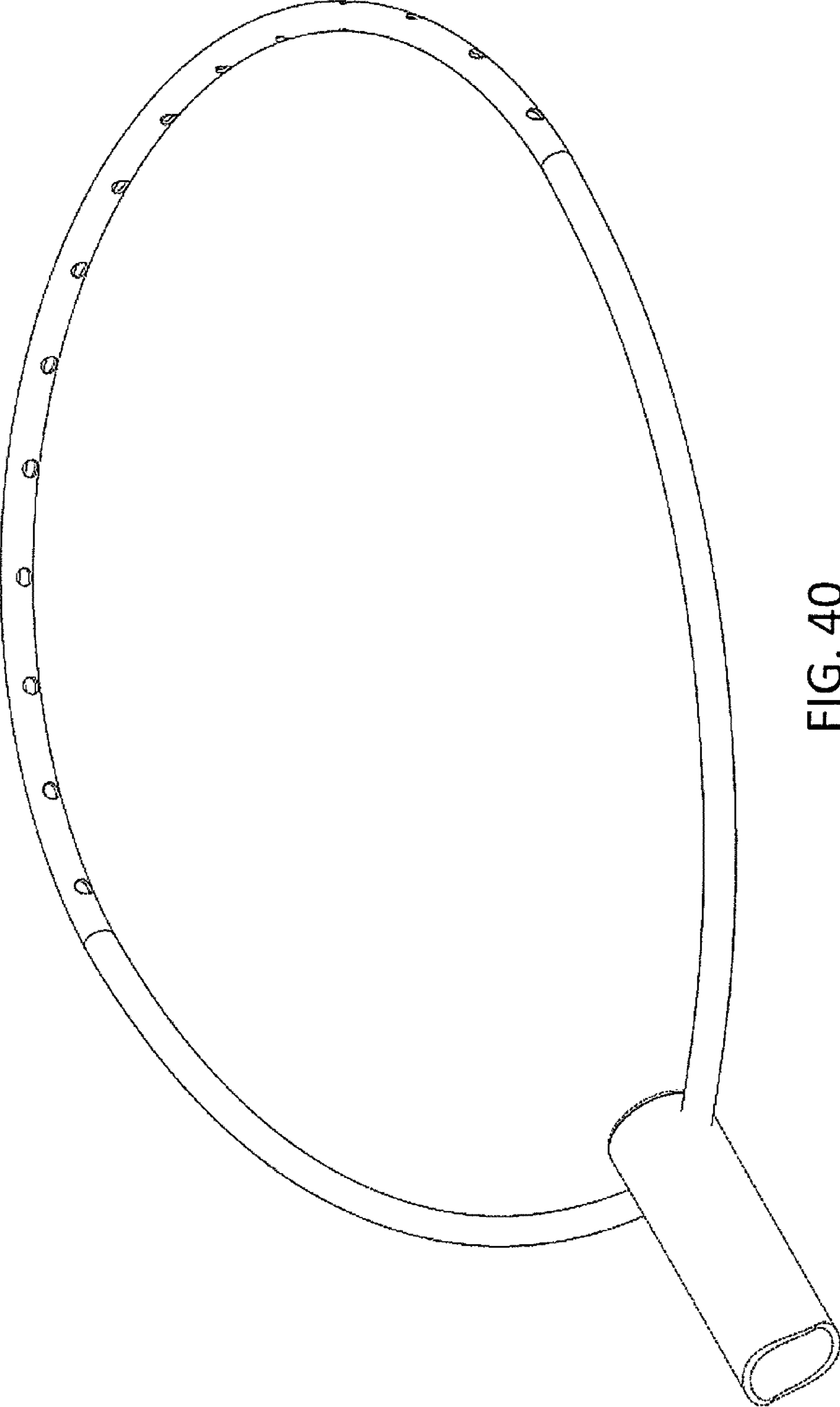

FIG. 40



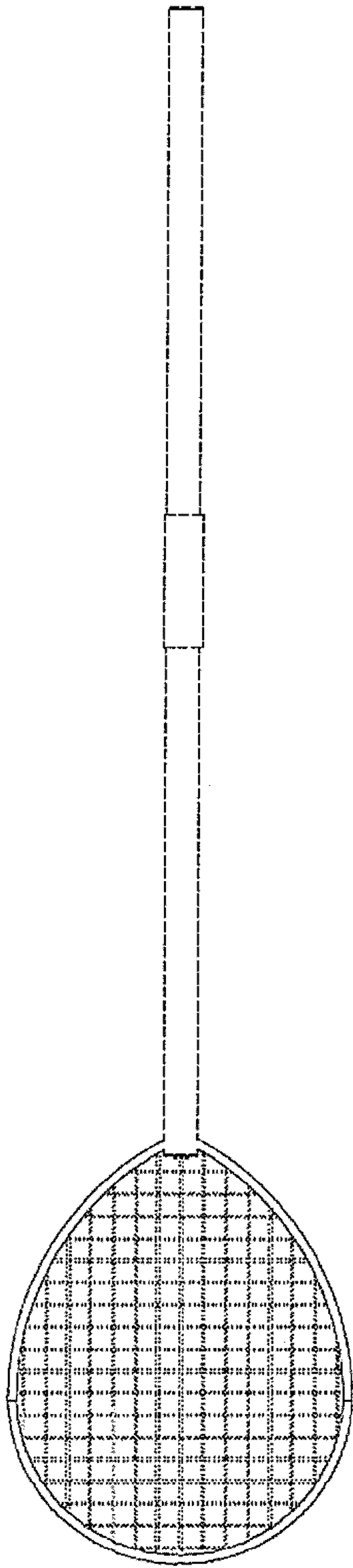

FIG. 41

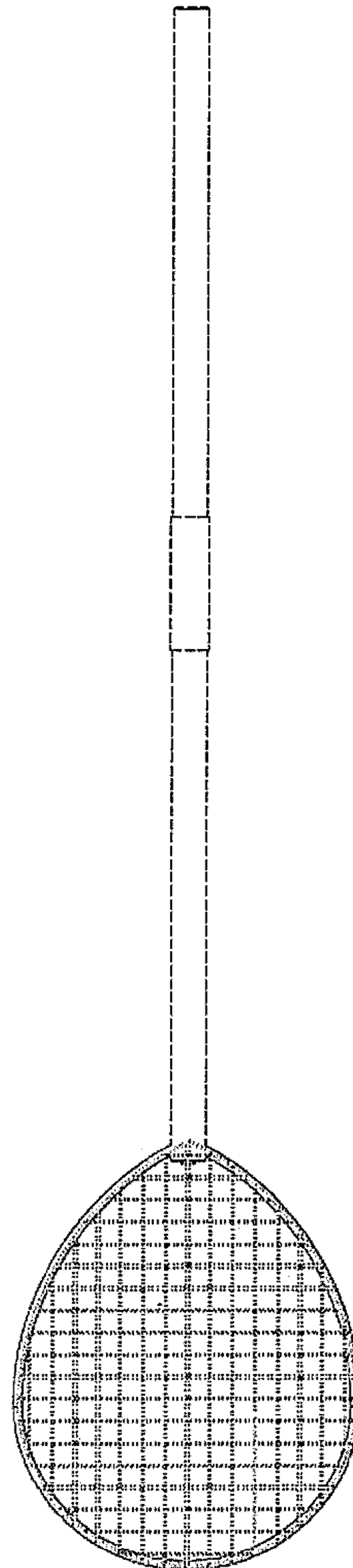

FIG. 42

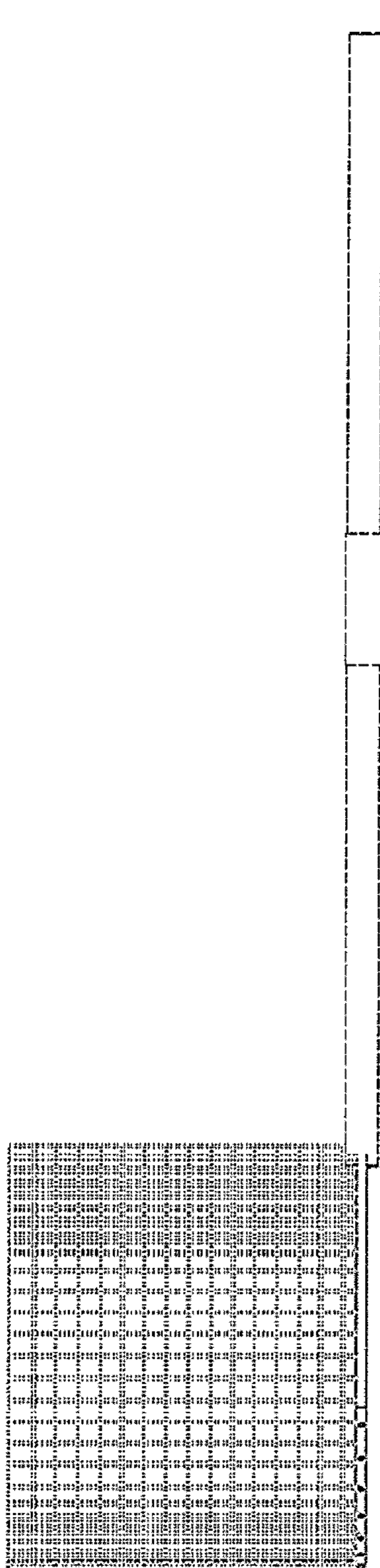

FIG. 43

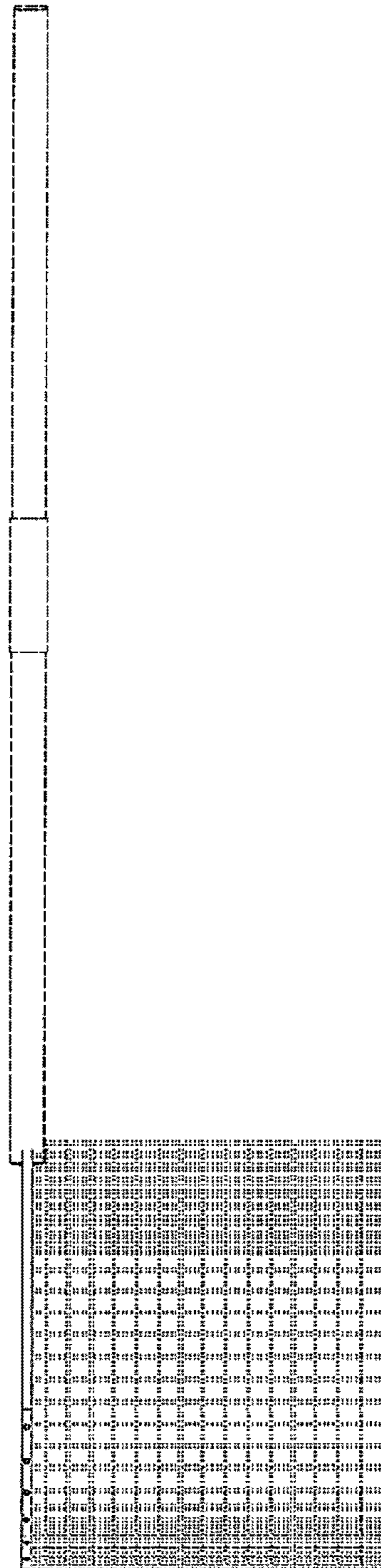

FIG. 44

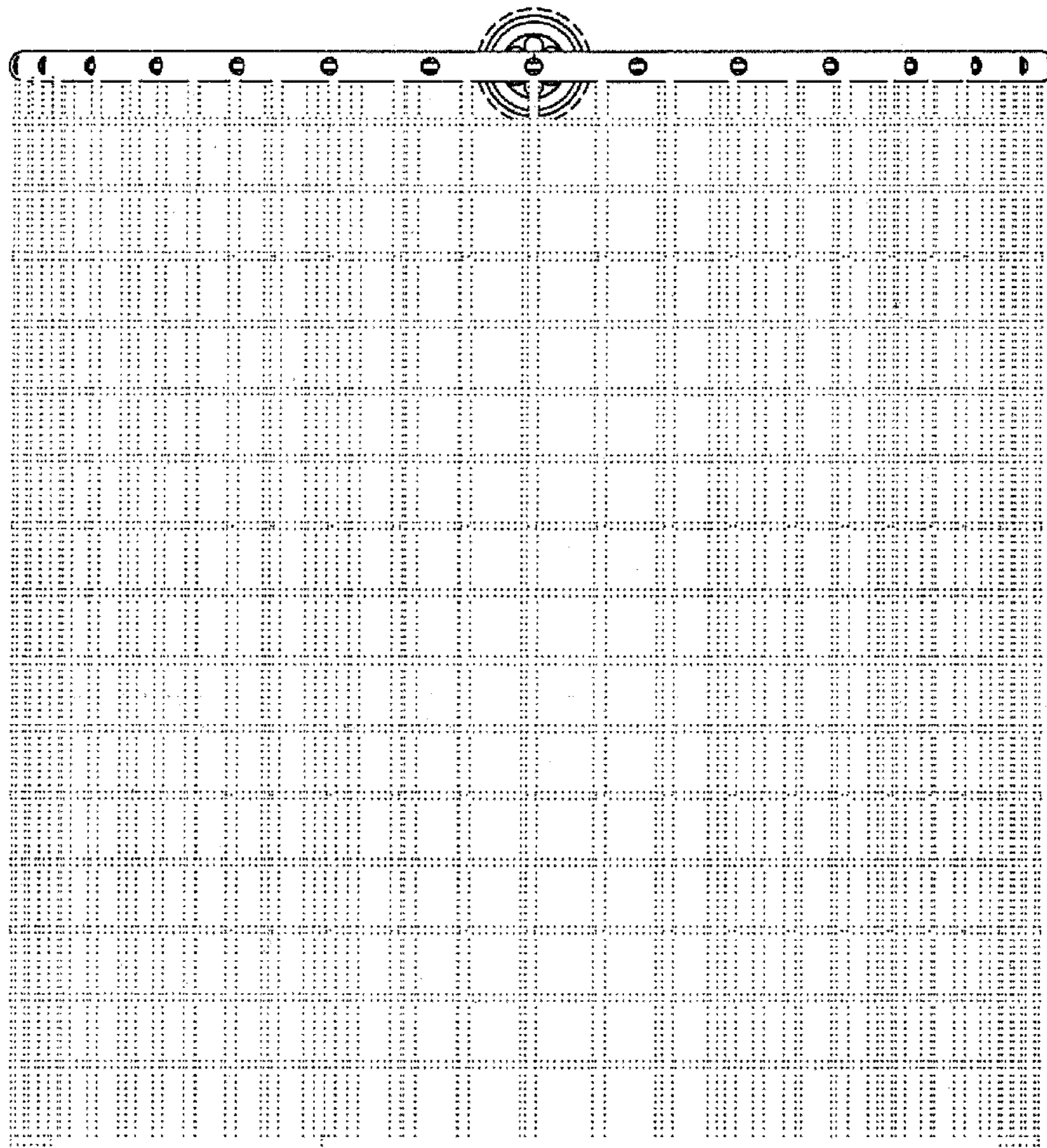

FIG. 45

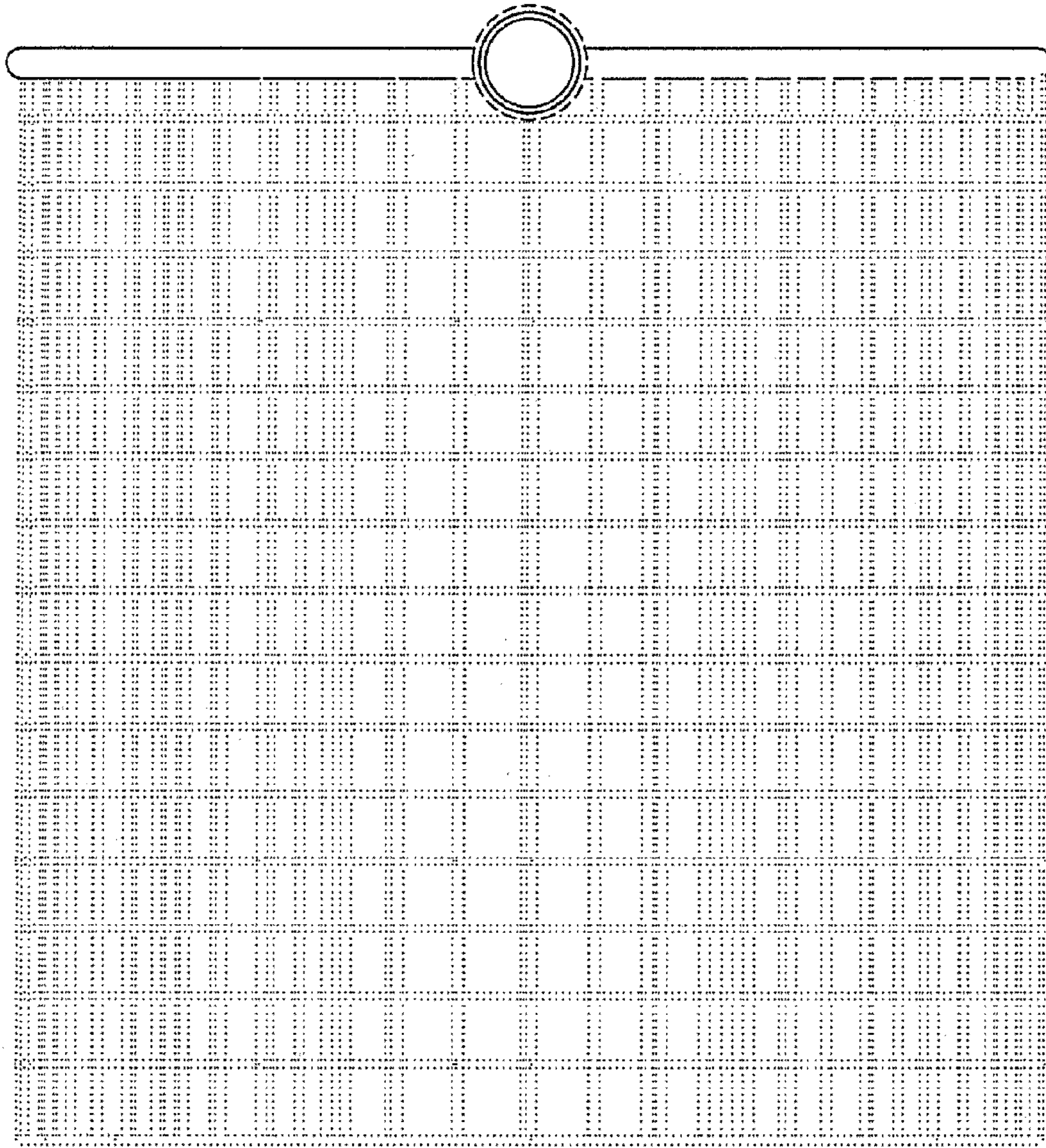

FIG. 46

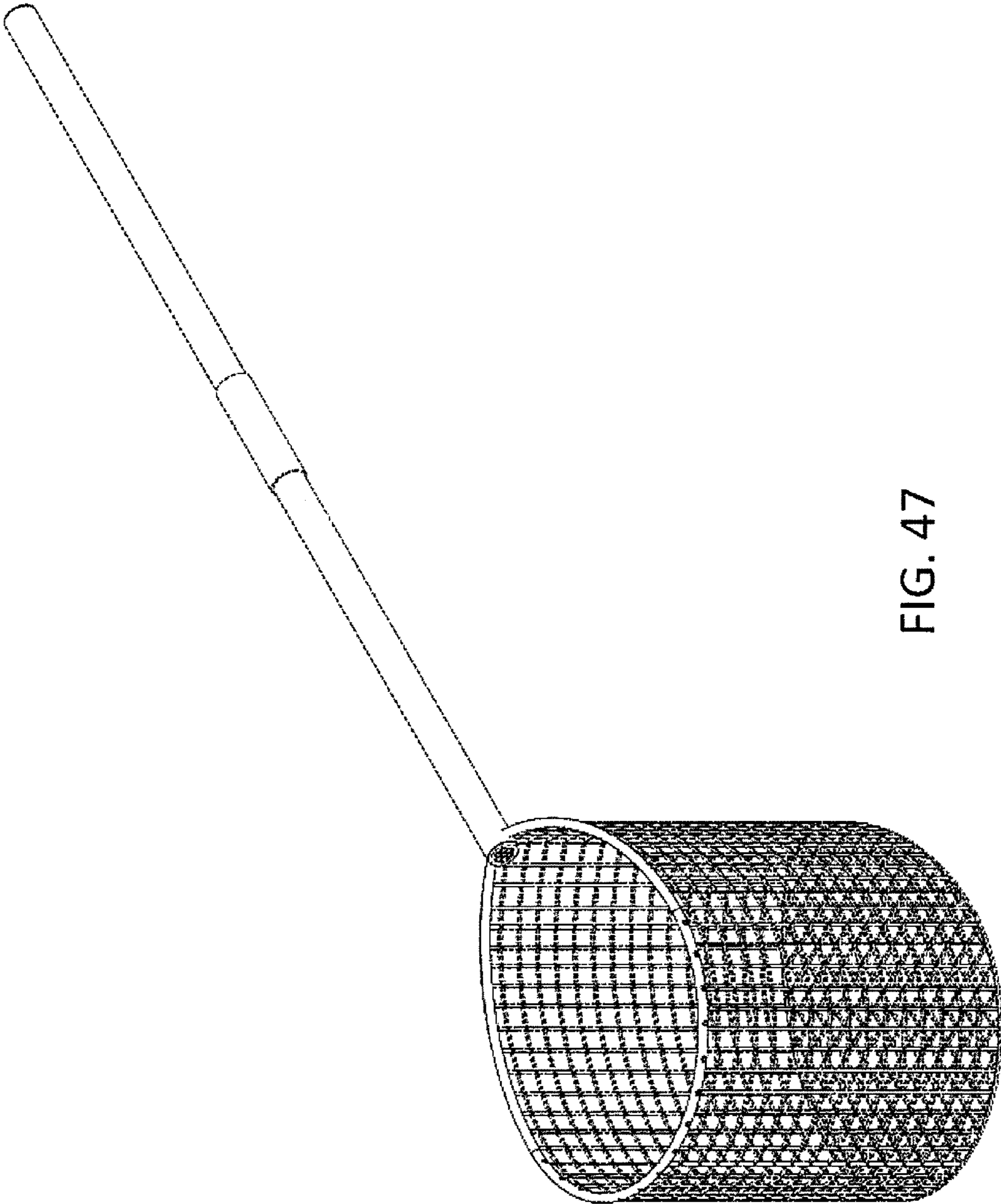

FIG. 47

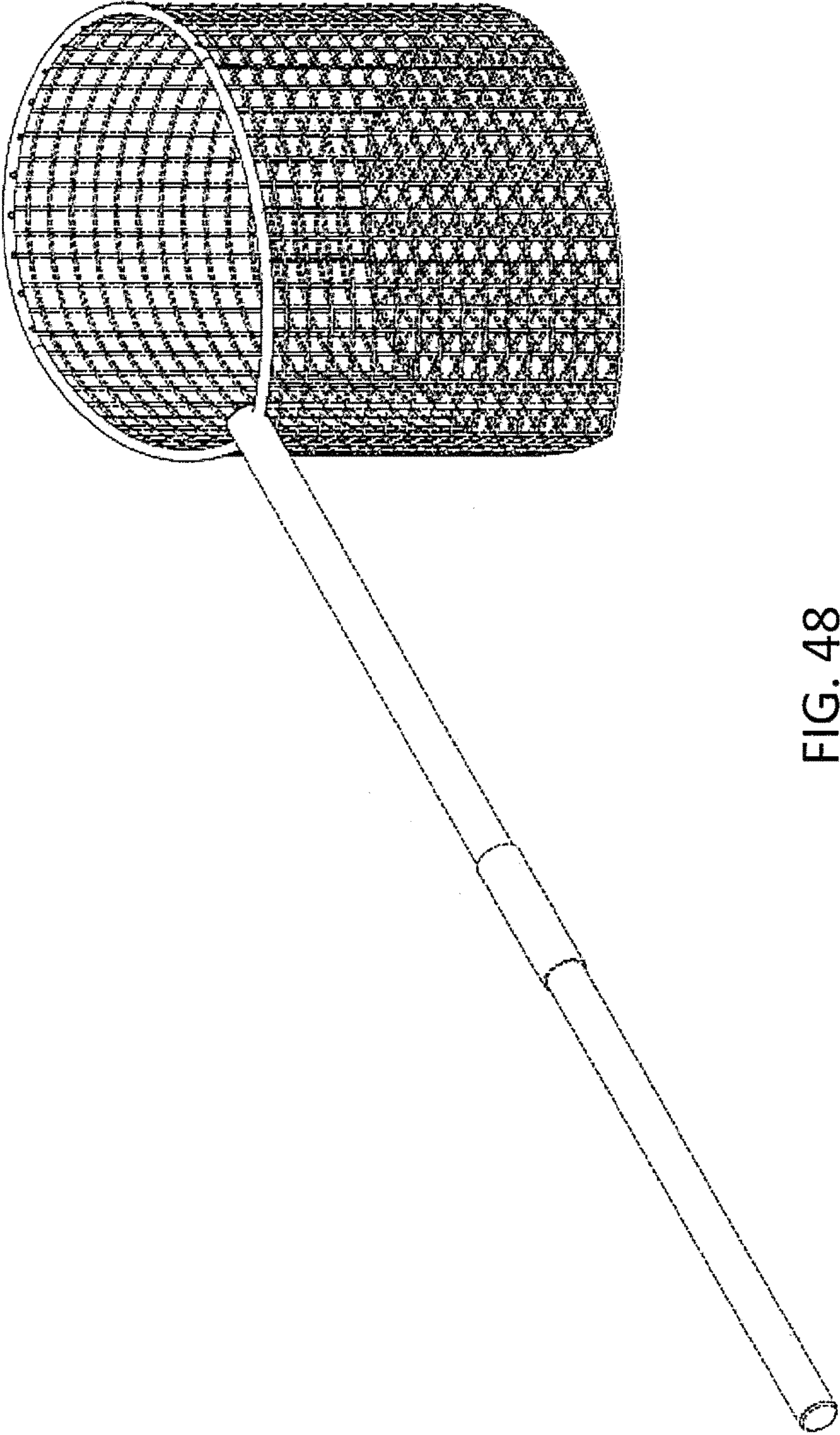

FIG. 48