



US00D743247S

(12) **United States Design Patent**
Solovov, Jr. et al.

(10) **Patent No.:** **US D743,247 S**

(45) **Date of Patent:** **** Nov. 17, 2015**

(54) **BOX FOR AMMUNITION**

(71) Applicant: **TULAMMO USA, INC.**, Round Rock, TX (US)

(72) Inventors: **Alexey Alexeevich Solovov, Jr.**, Tula (RU); **Maxim Nikolaevich Buyanov**, Tula (RU)

(73) Assignee: **TULAMMO USA, INC.**, Round Rock, TX (US)

(**) Term: **14 Years**

(21) Appl. No.: **29/503,545**

(22) Filed: **Sep. 26, 2014**

(51) **LOC (10) Cl.** **09-03**

(52) **U.S. Cl.**
USPC **D9/414**

(58) **Field of Classification Search**
USPC D9/414, 415, 751, 423, 416, 432, 434, D9/600, 720; D19/90; D24/230; 206/443, 206/276, 553, 273; 229/228, 224, 225, 116, 229/221, 208
CPC B65D 85/20; B65D 5/5435; B65D 5/543; A24F 13/16; A47G 21/14
See application file for complete search history.

(56) **References Cited**

U.S. PATENT DOCUMENTS

2,354,239	A *	7/1944	Williamson	206/273
2,788,827	A *	4/1957	Banner	206/553
3,235,167	A *	2/1966	Svensson	229/228
3,595,466	A *	7/1971	Rosenburg, Jr.	229/208
3,893,614	A *	7/1975	Meyers	229/228
4,003,516	A *	1/1977	Commerford et al.	229/208
4,083,455	A *	4/1978	Keating, Jr.	229/224

(Continued)

Primary Examiner — Holly Baynham

Assistant Examiner — Rhea Shields

(74) *Attorney, Agent, or Firm* — Polsinelli PC

(57) **CLAIM**

The ornamental design for a box for ammunition, as shown and described.

DESCRIPTION

U.S. Design Patent Applications filed on Sep. 26, 2014, with inventors Alexey Alexeevich Solovov, Jr. and Maxim Nikolaevich Buyanov, and identified by Ser. Nos. 29/503,546, 29/503,548, 29/503,535 and 29/503,553 are hereby incorporated by reference in their entireties.

FIG. 1 is a perspective view of the box for ammunition;
FIG. 2 is a front view of the box for ammunition;
FIG. 3 is a rear view of the box for ammunition;
FIG. 4 is a right side view of the box for ammunition;
FIG. 5 is a left side view of the box for ammunition;
FIG. 6 is a top view of the box for ammunition;
FIG. 7 is a bottom view of the box for ammunition;
FIG. 8 is perspective view of the box for ammunition in a flattened configuration;
FIG. 9 is a top view of the box for ammunition in a flattened configuration;
FIG. 10 is a bottom view of the box for ammunition in a flattened configuration;
FIG. 11 is a front view of the box for ammunition in a flattened configuration;
FIG. 12 is a rear view of the box for ammunition in a flattened configuration;
FIG. 13 is a left view of the box for ammunition in a flattened configuration; and,
FIG. 14 is a right view of the box for ammunition in a flattened configuration.

In the drawings, the broken lines are for the purpose of illustrating environment only and form no part of the claimed design.

1 Claim, 7 Drawing Sheets

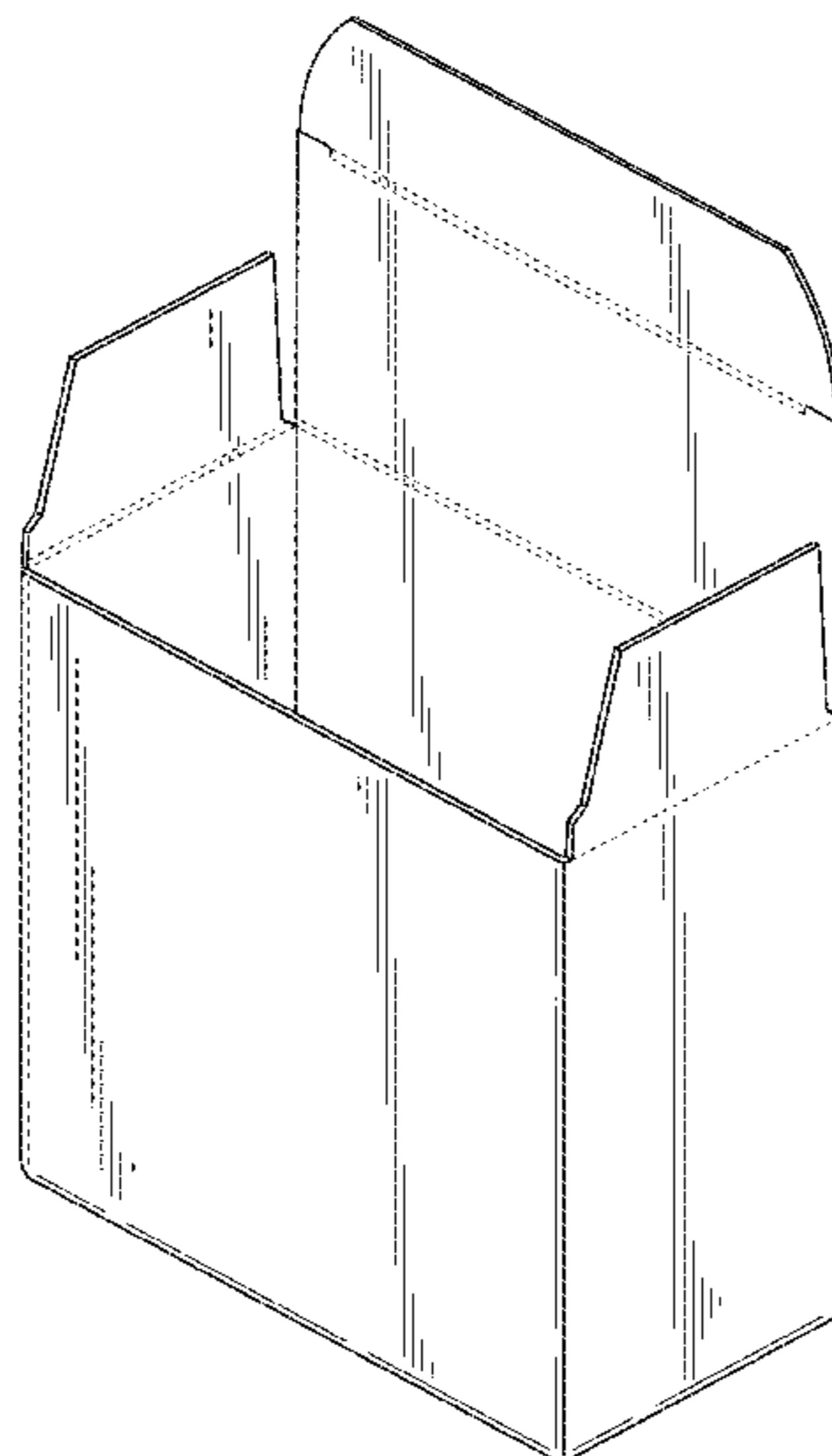

(56)

References Cited

U.S. PATENT DOCUMENTS

D294,805 S *	3/1988	Boyer	D9/415	D533,078 S *	12/2006	Lebras	D9/751
D298,515 S *	11/1988	Pennell	D9/423	D583,660 S *	12/2008	Steiger et al.	D9/432
D337,940 S *	8/1993	Aquino	D19/90	D606,855 S *	12/2009	Jo et al.	D9/423
D345,101 S *	3/1994	Abrams	D9/423	8,328,078 B2 *	12/2012	Modha et al.	229/221
D346,326 S *	4/1994	Price et al.	D9/720	D693,680 S *	11/2013	Klopp et al.	D9/434
D376,759 S *	12/1996	Bradfield	D9/432	D695,605 S *	12/2013	Johnson	D9/423
D444,381 S *	7/2001	Barr	D9/416	D696,135 S *	12/2013	Larson et al.	D9/600
6,604,676 B2 *	8/2003	Giblin	229/225	D696,960 S *	1/2014	Larson et al.	D9/600
				D726,533 S *	4/2015	Northrup	D9/434
				2012/0234904 A1 *	9/2012	Costanzo, Jr.	229/116.5

* cited by examiner

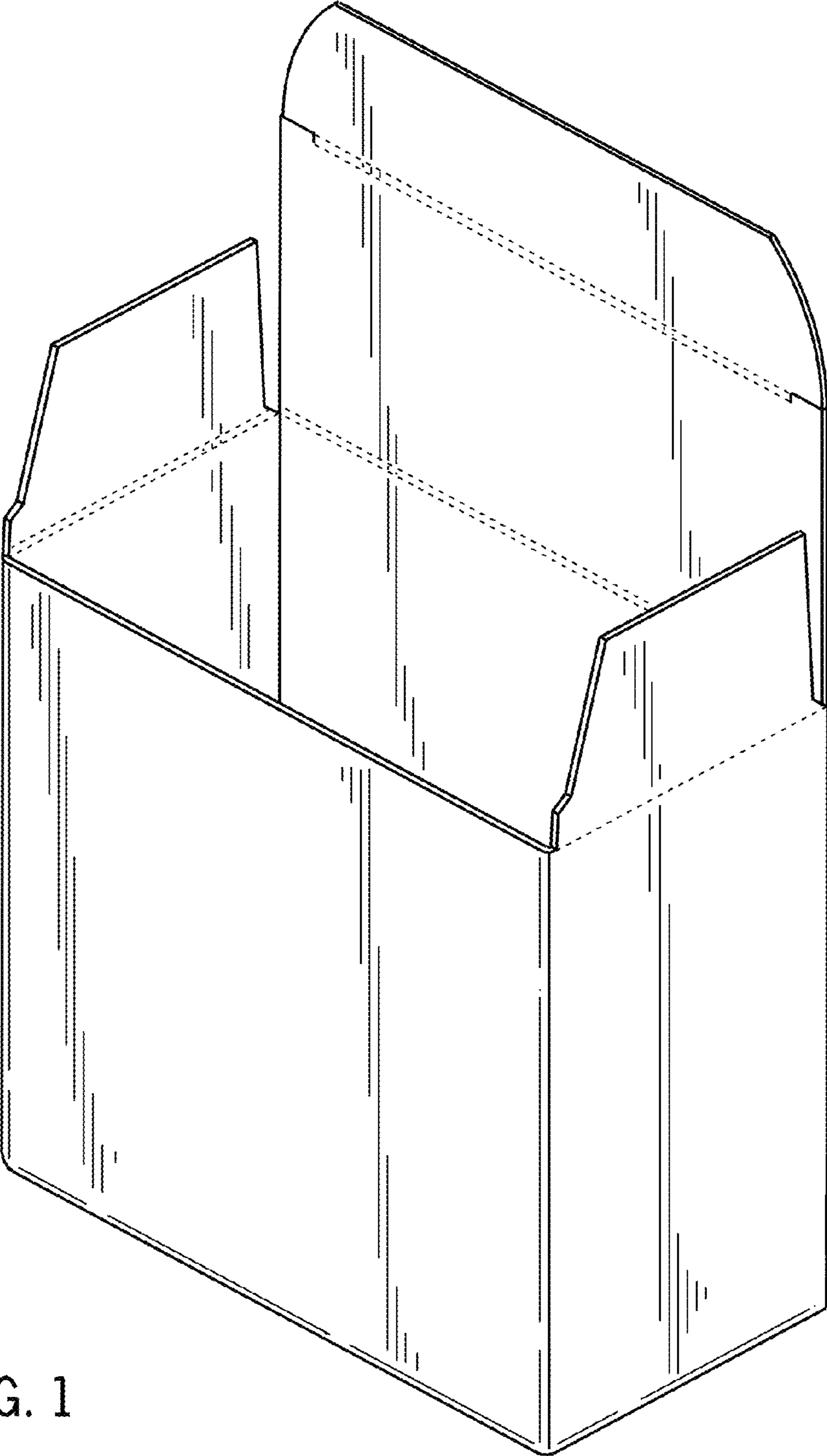

FIG. 1

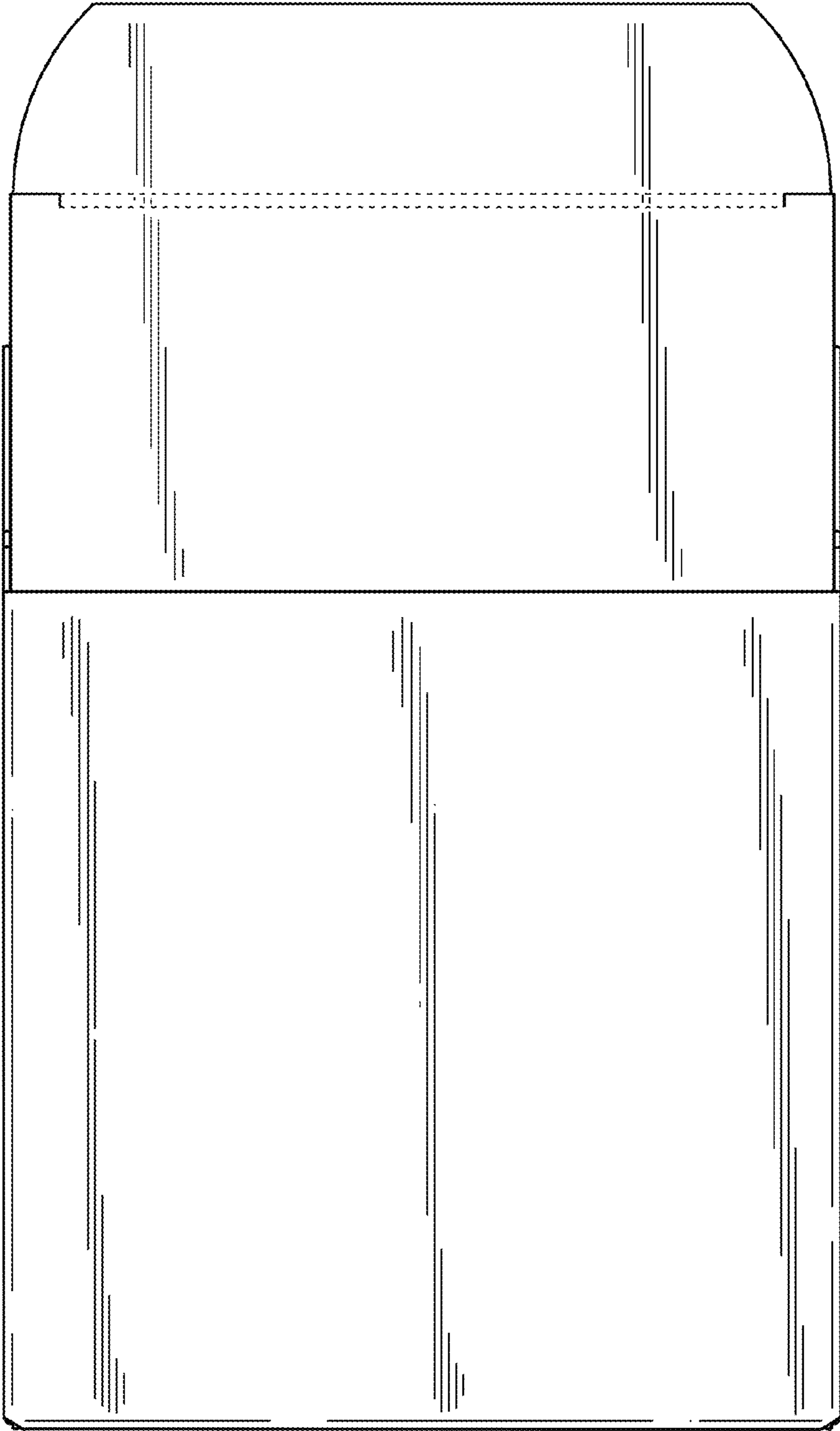

FIG. 2

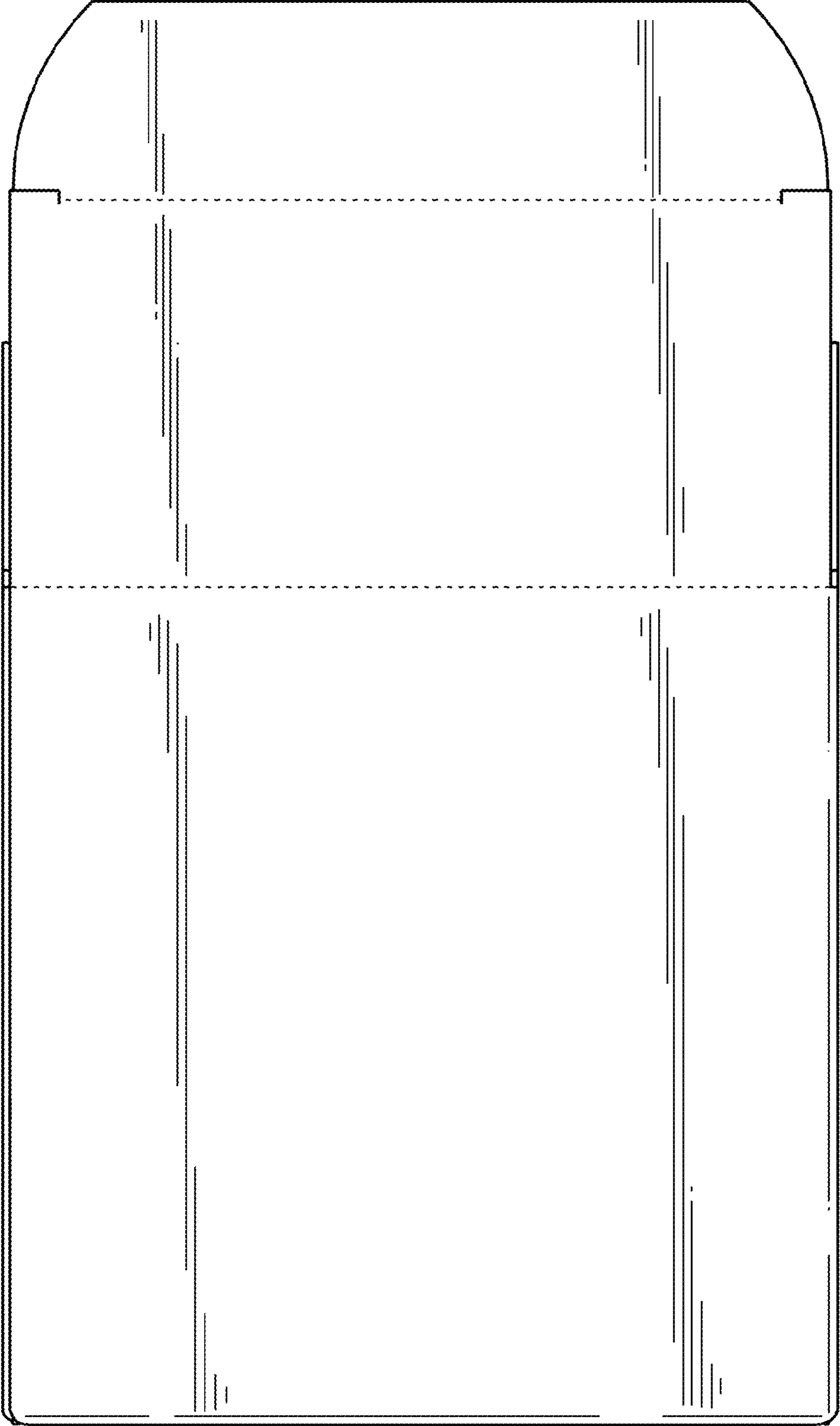

FIG. 3

FIG. 4

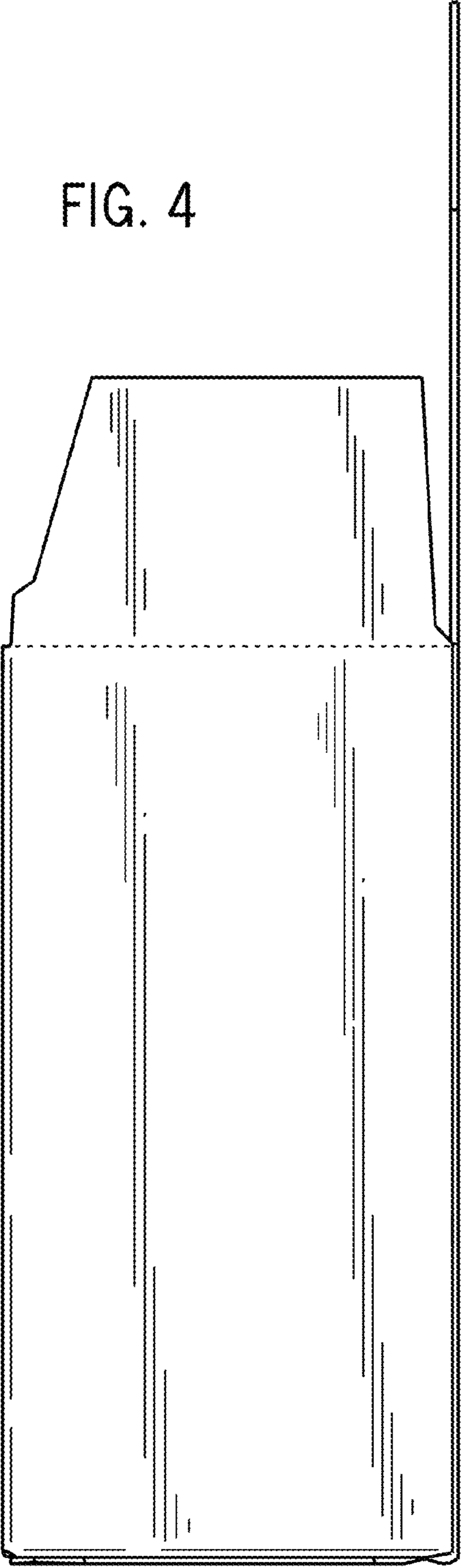
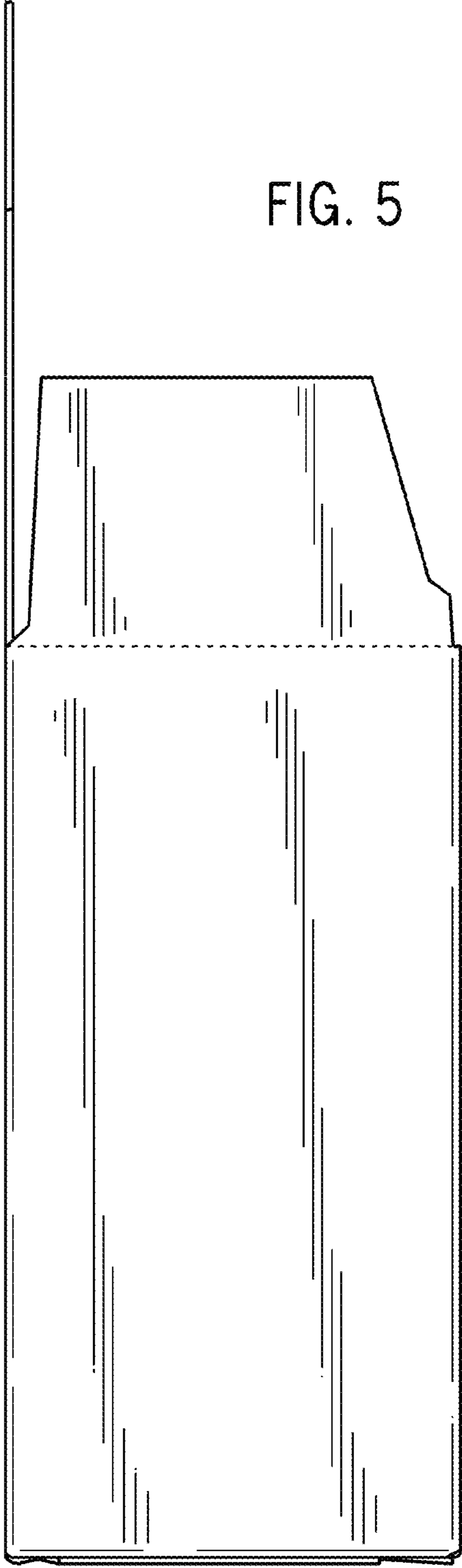

FIG. 5



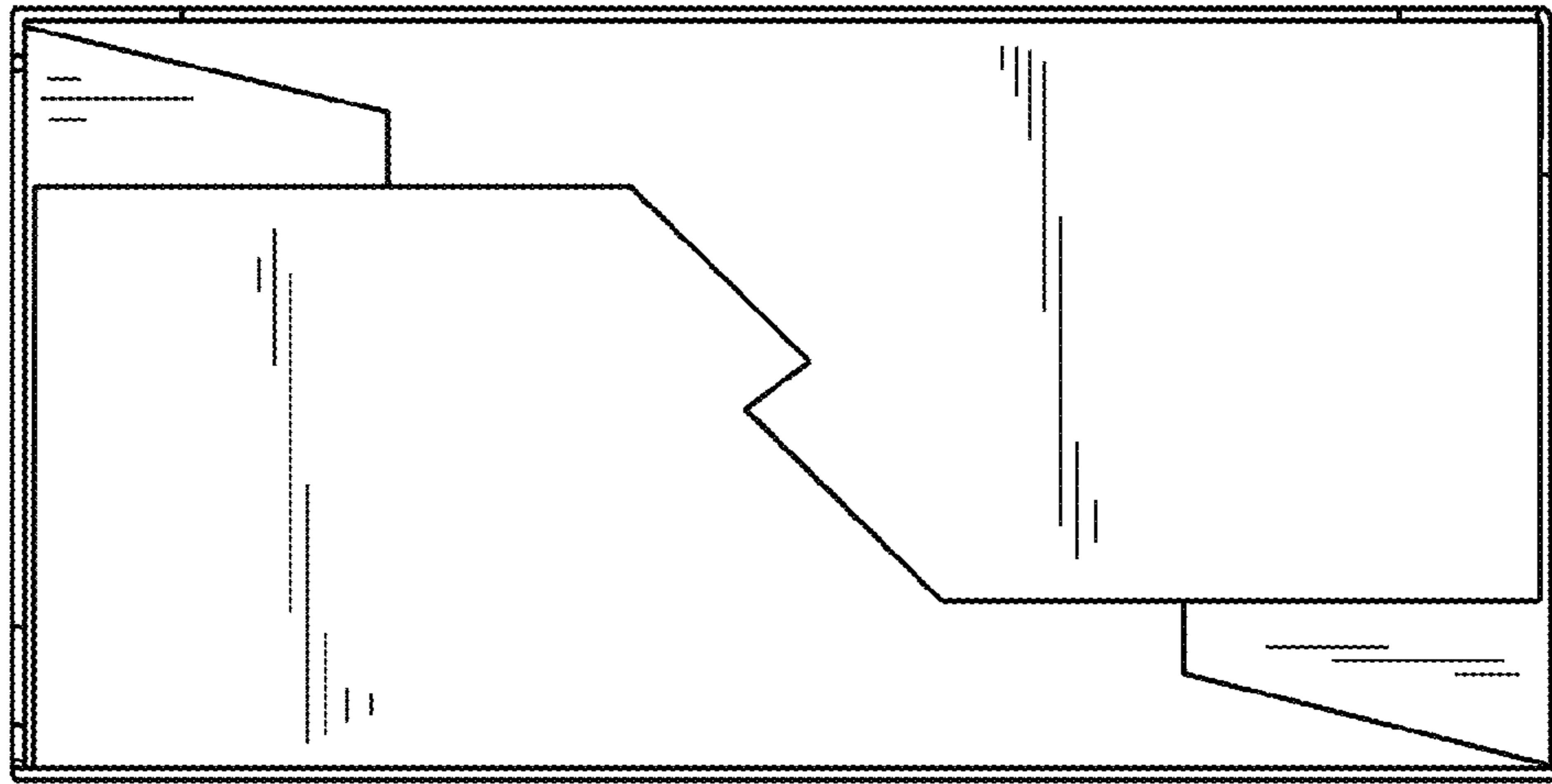

FIG. 6

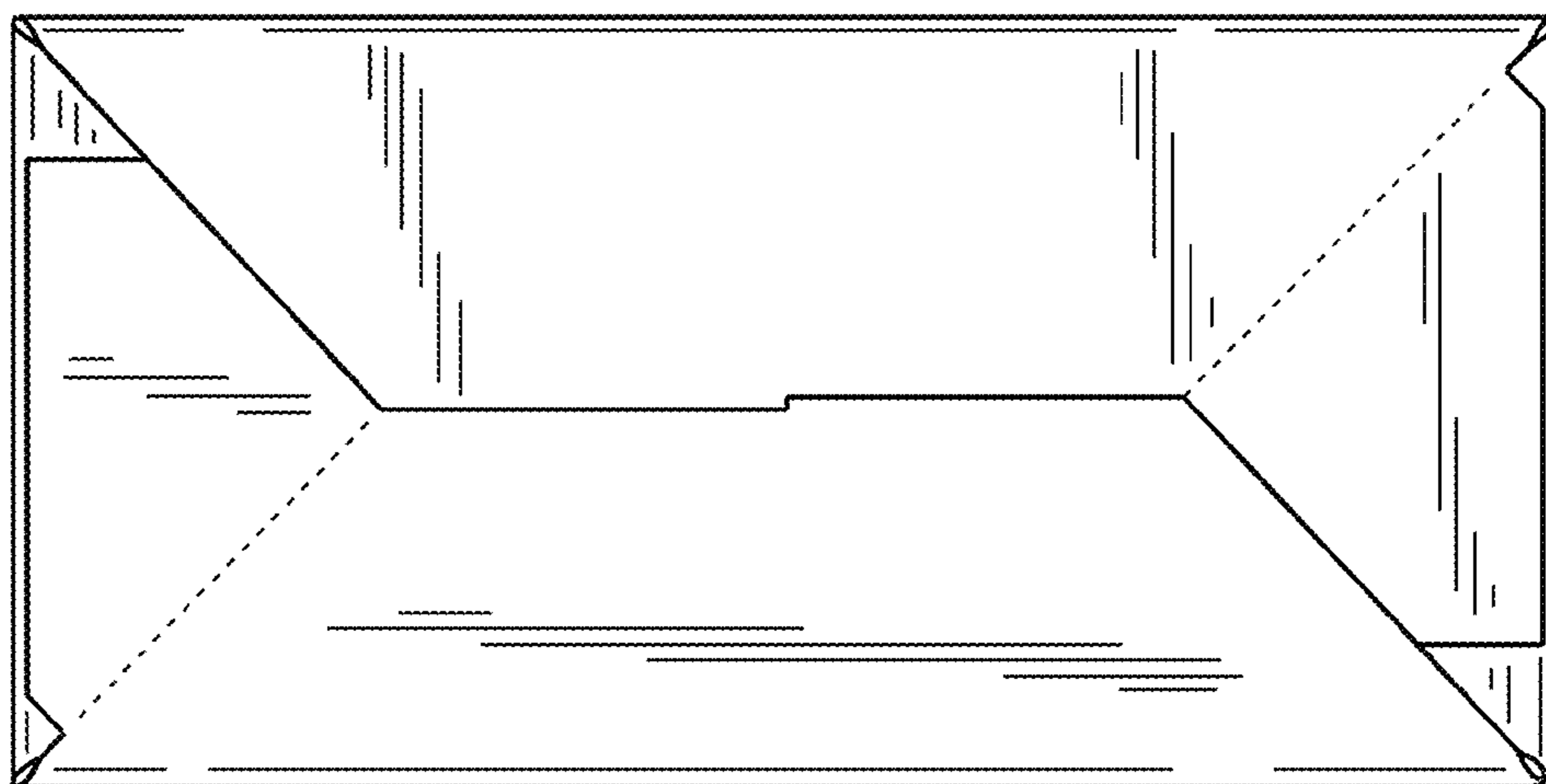

FIG. 7

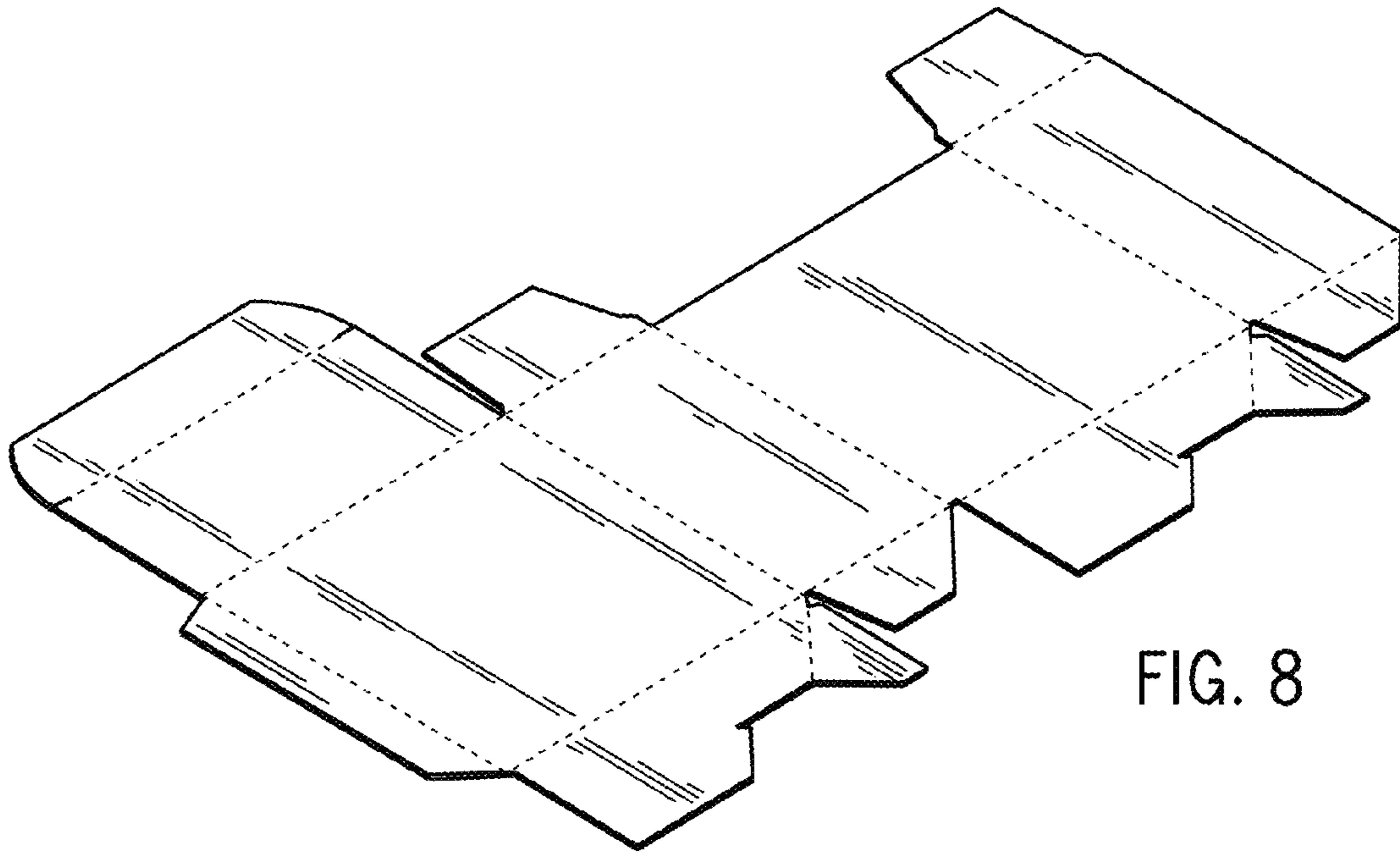

FIG. 8

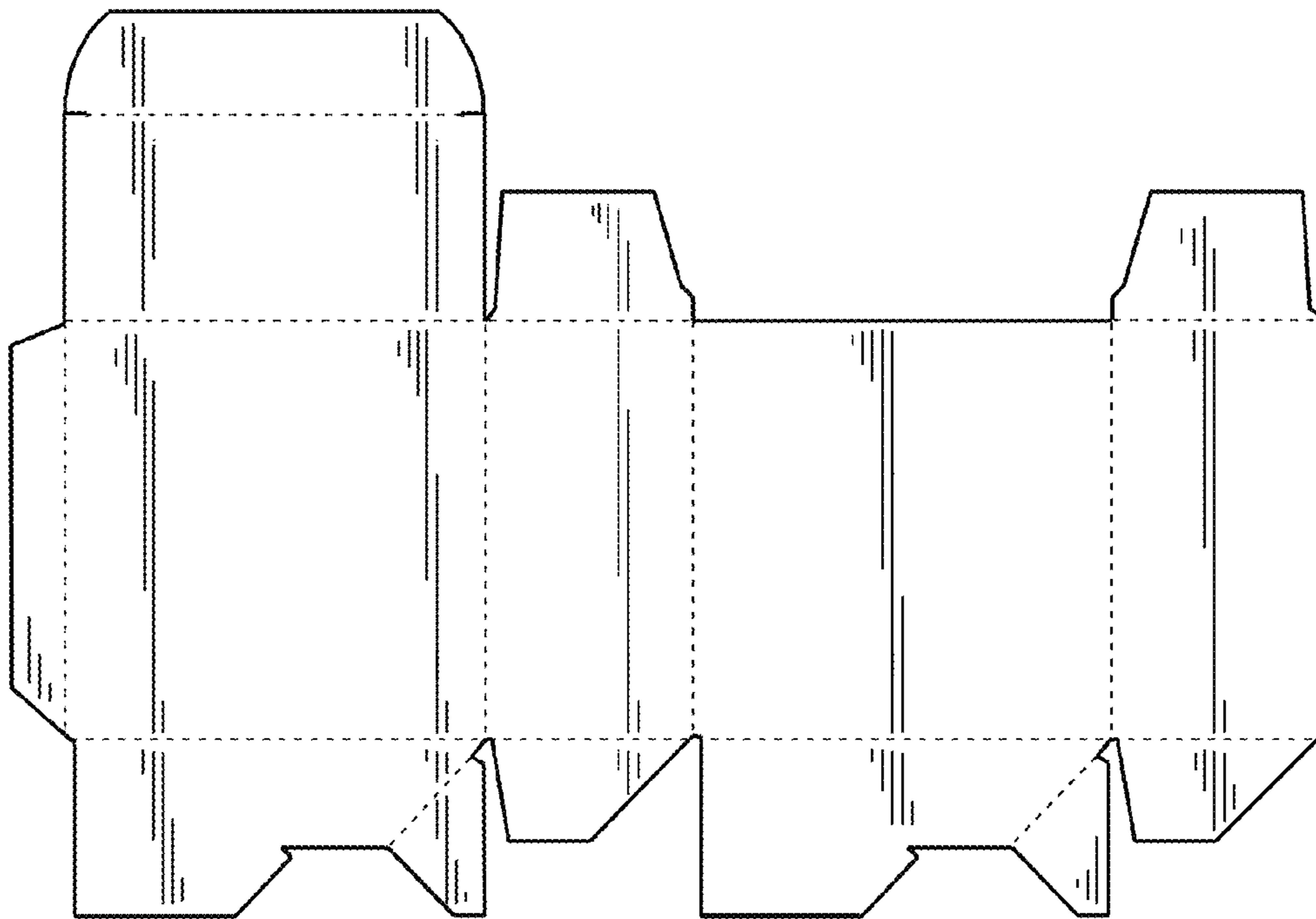

FIG. 9

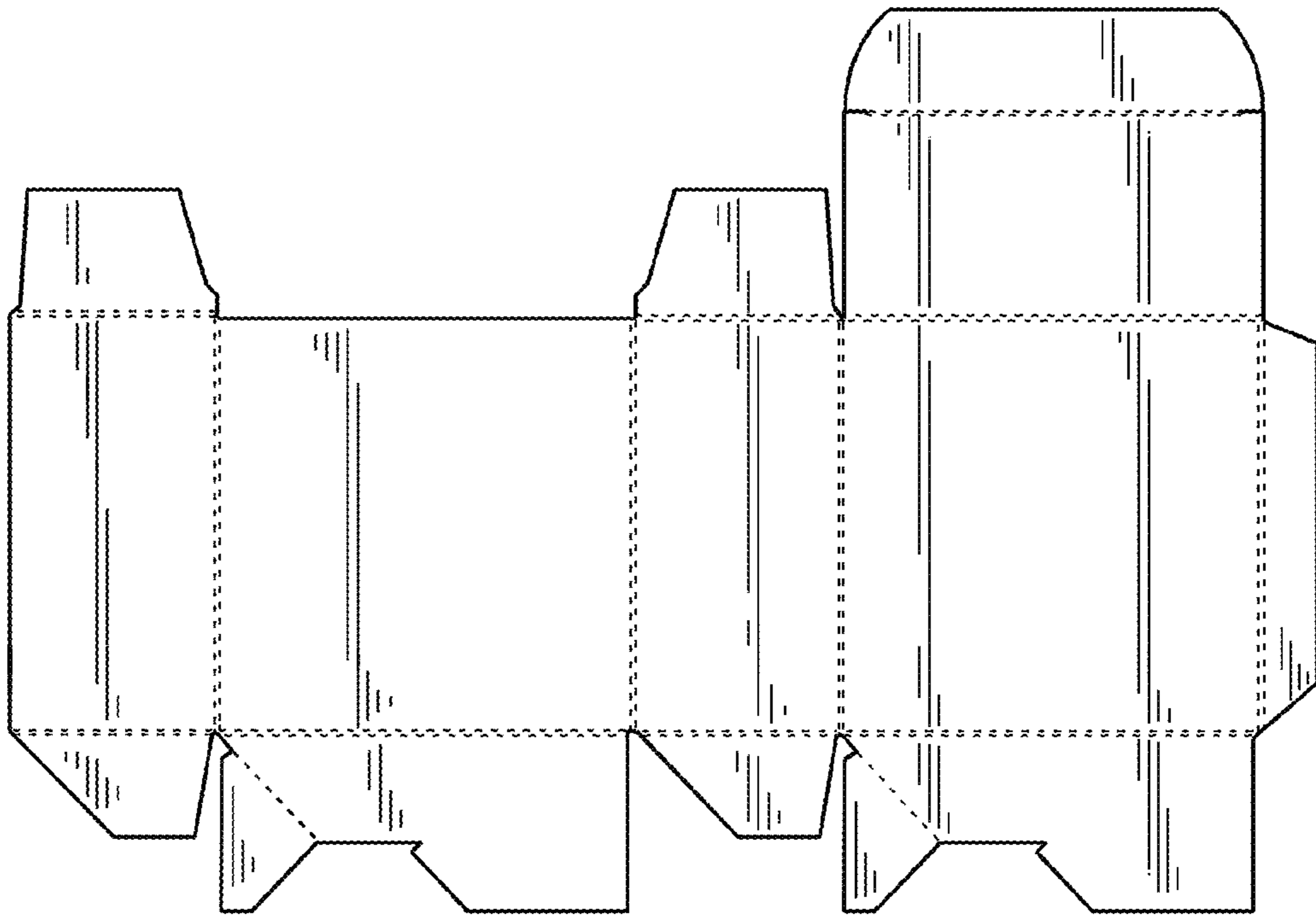

FIG. 10

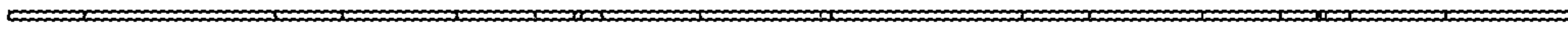

FIG. 11

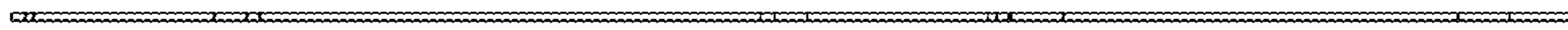

FIG. 12

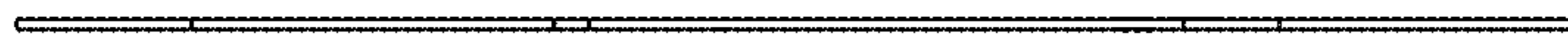

FIG. 13

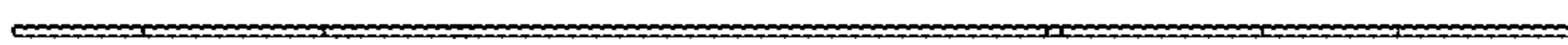

FIG. 14