



US00D743148S

(12) **United States Design Patent**
Hanlon

(10) **Patent No.:** **US D743,148 S**

(45) **Date of Patent:** **** Nov. 17, 2015**

(54) **HAIR CUTTING CAPE**

(71) Applicant: **Robb S. Hanlon**, Fishkill, NY (US)

(72) Inventor: **Robb S. Hanlon**, Fishkill, NY (US)

(**) Term: **14 Years**

(21) Appl. No.: **29/498,771**

(22) Filed: **Aug. 7, 2014**

(51) **LOC (10) Cl.** **02-02**

(52) **U.S. Cl.**
USPC **D2/860**

(58) **Field of Classification Search**
USPC D2/823-826, 728, 860-864, 700, 720,
D2/724, 725, 740; 2/46, 48, 49.1, 49.4-51,
2/83, 84, 88, 114, 69.5, 69, 80, 50, 104,
2/52, 90, 93
CPC A41D 1/00; A41D 1/02; A41D 1/04;
A41D 3/08
See application file for complete search history.

(56) **References Cited**

U.S. PATENT DOCUMENTS

D157,696 S *	3/1950	Paque	D2/839
D294,305 S *	2/1988	Meek	2/94
6,119,270 A *	9/2000	Chou	A41D 3/00 2/108
D529,687 S *	10/2006	Rindle	D2/828
D654,664 S *	2/2012	Evans	D2/839
D694,992 S *	12/2013	Farron	D2/828
D702,920 S *	4/2014	Chaney	D2/739
D733,400 S *	7/2015	Cunningham	D2/720

* cited by examiner

Primary Examiner — Caron D Veynar

Assistant Examiner — Abraham Bahta

(74) *Attorney, Agent, or Firm* — Law Offices of Michael L. Wise, LLC

(57) **CLAIM**

The ornamental design for a hair cutting cape, as shown and described.

DESCRIPTION

FIG. 1 is a front perspective view of a first embodiment of my new design;
FIG. 2 is a front elevational view thereof;
FIG. 3 is a rear elevational view thereof;
FIG. 4 is a left elevational view thereof;
FIG. 5 is a right elevational view thereof;
FIG. 6 is a top side view thereof;
FIG. 7 is a bottom side view thereof;
FIG. 8 is a magnified front perspective view of a portion thereof with a neck flap in the open position;
FIG. 9 is a front perspective view of a second embodiment of my new design;
FIG. 10 is a front elevational view thereof;
FIG. 11 is a rear elevational view thereof;
FIG. 12 is a left elevational view thereof;
FIG. 13 is a right elevational view thereof;
FIG. 14 is a top side view thereof;
FIG. 15 is a bottom side view thereof; and,
FIG. 16 is a magnified front perspective view of a portion thereof with a neck flap in the open position.
The broken line showing of portions of the hair cutting cape is included for the purpose of illustrating environmental structure and forms no part of the claimed design.

1 Claim, 12 Drawing Sheets

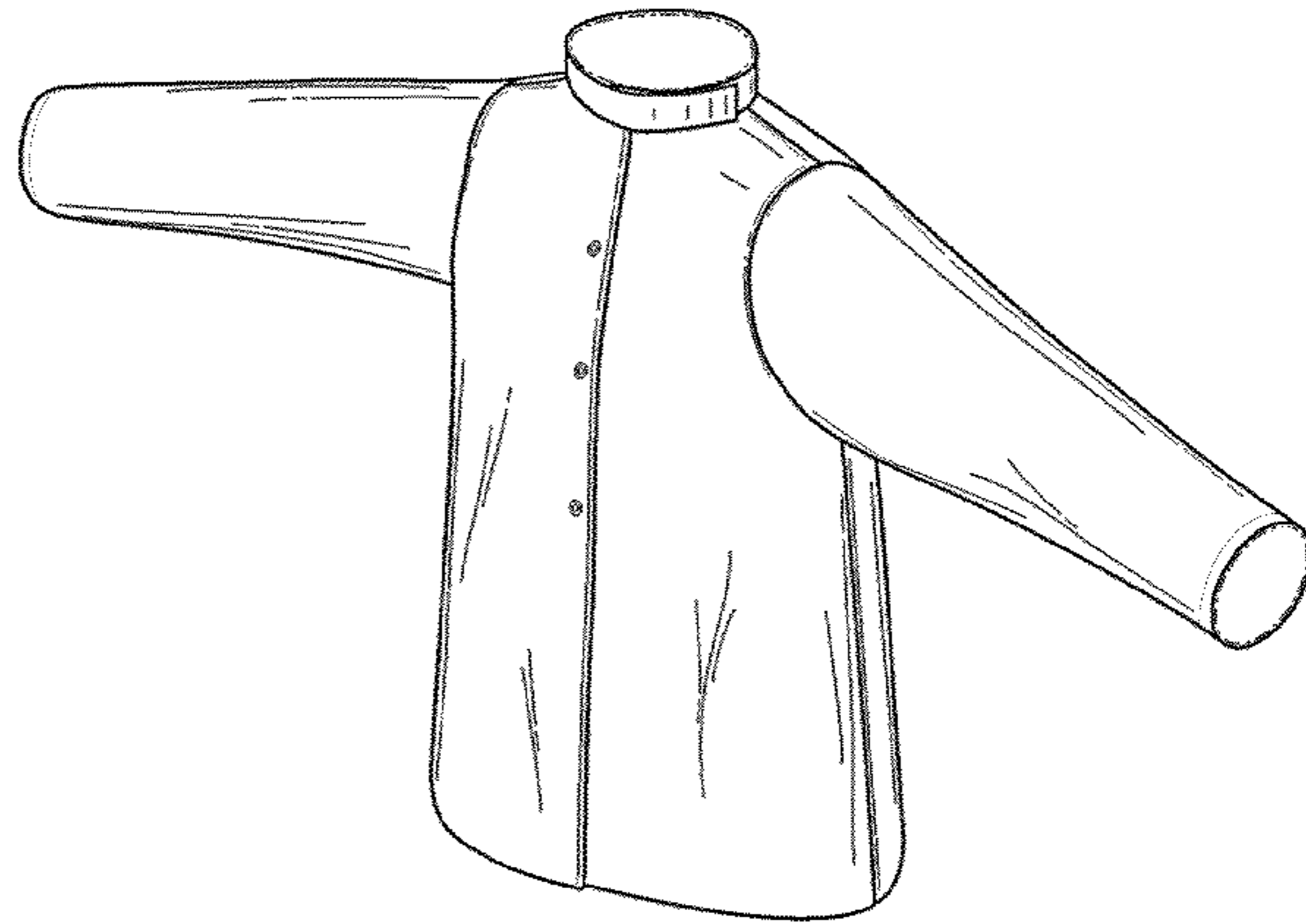
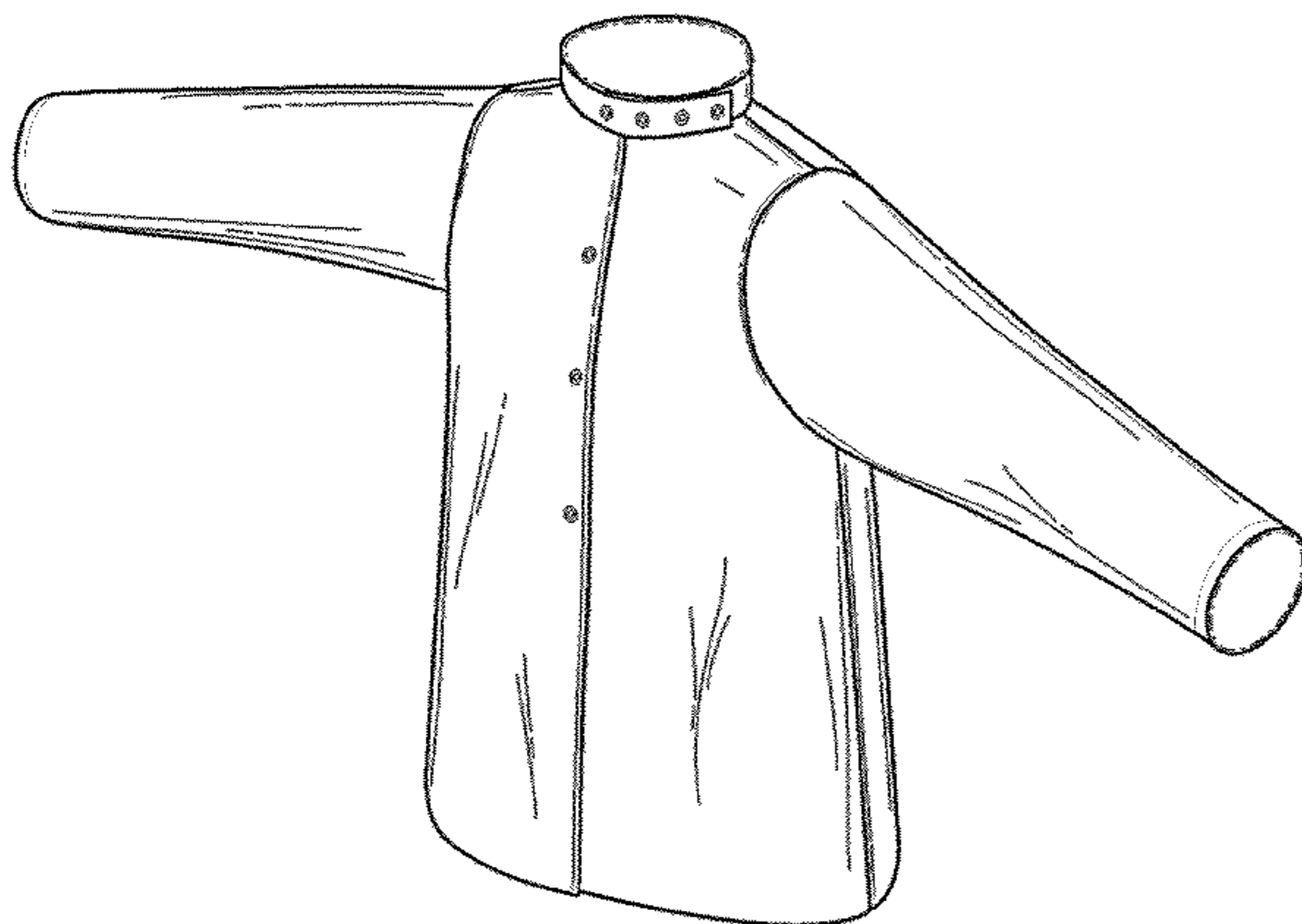

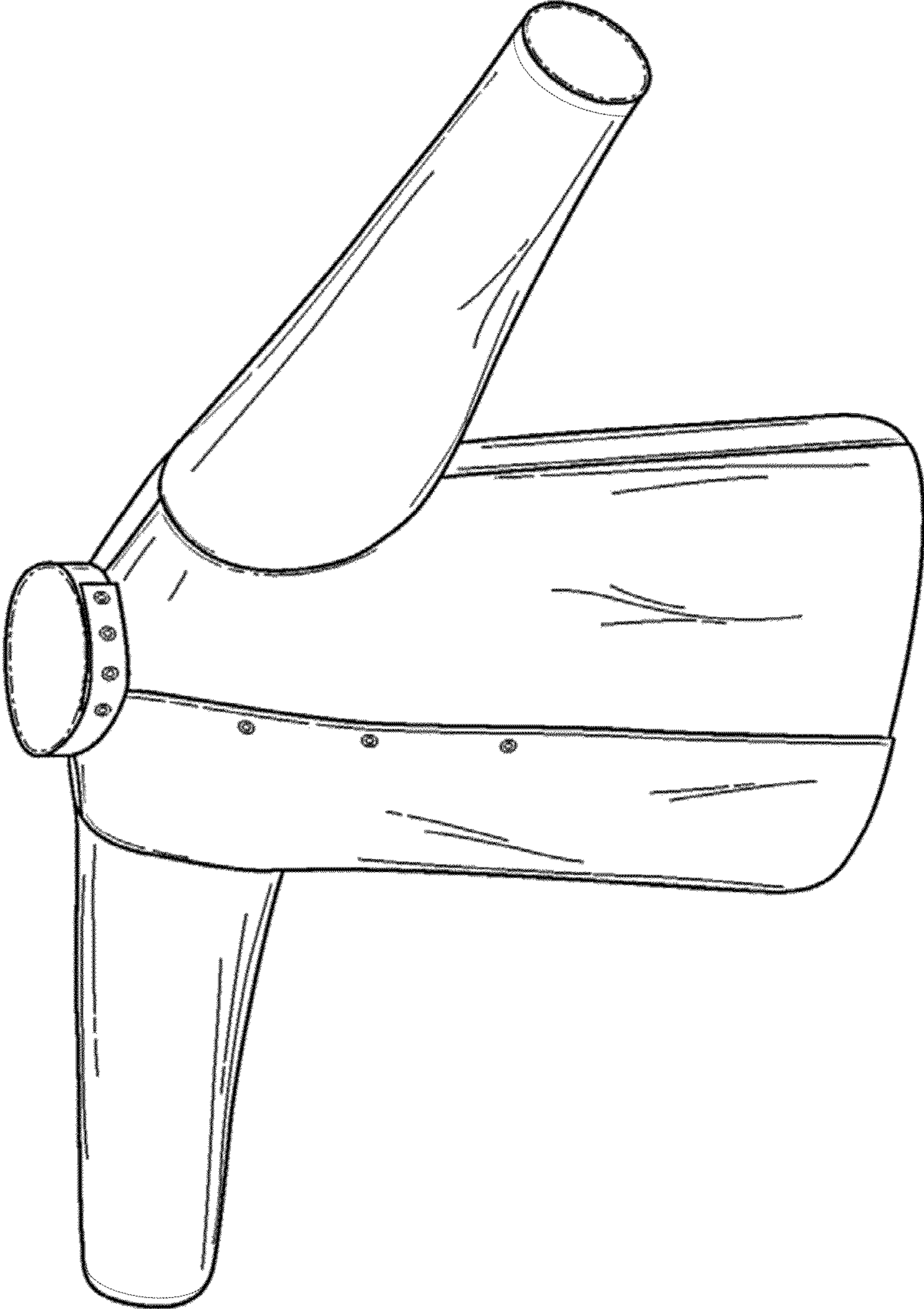

FIG. 1

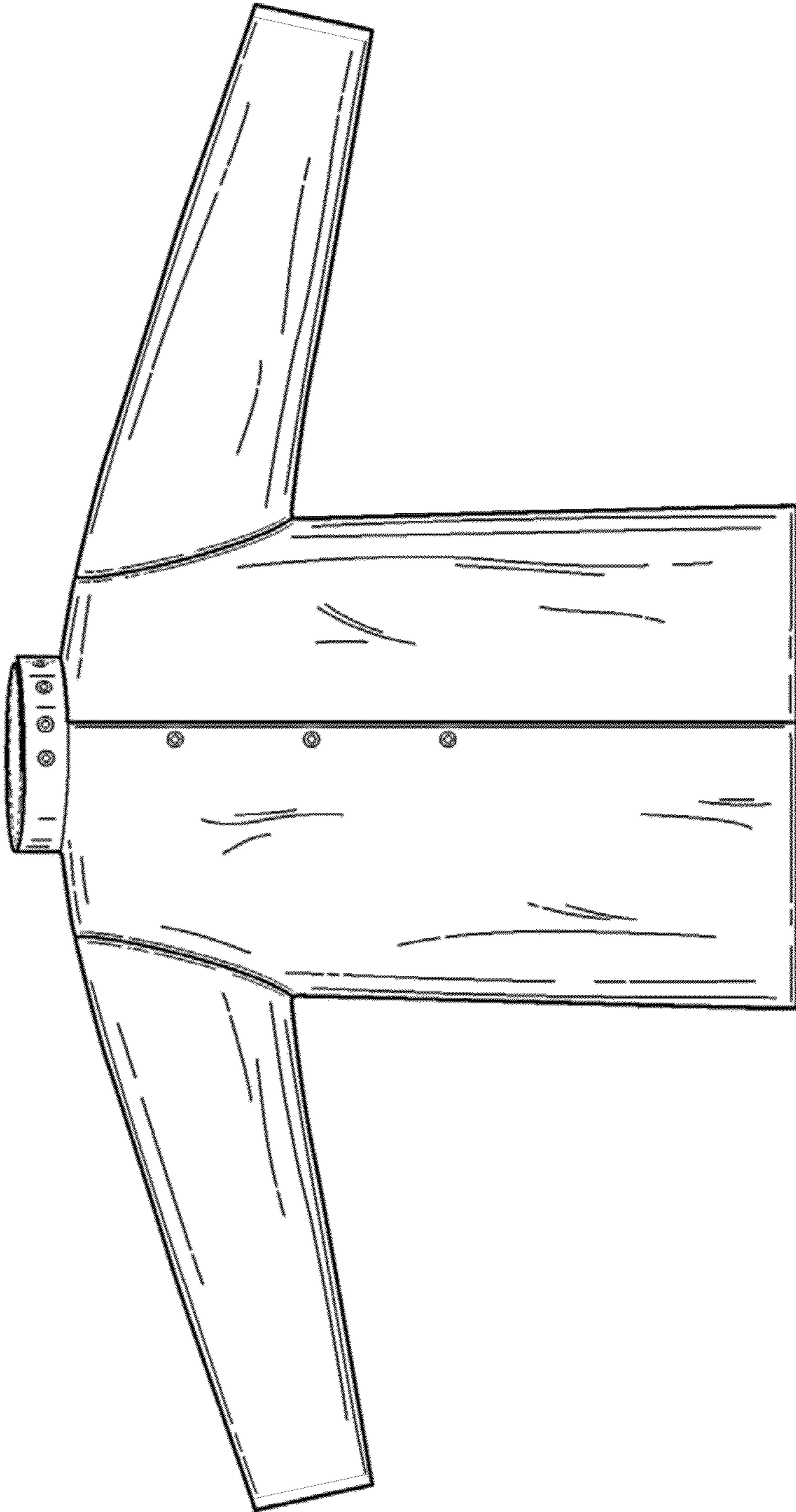

FIG. 2

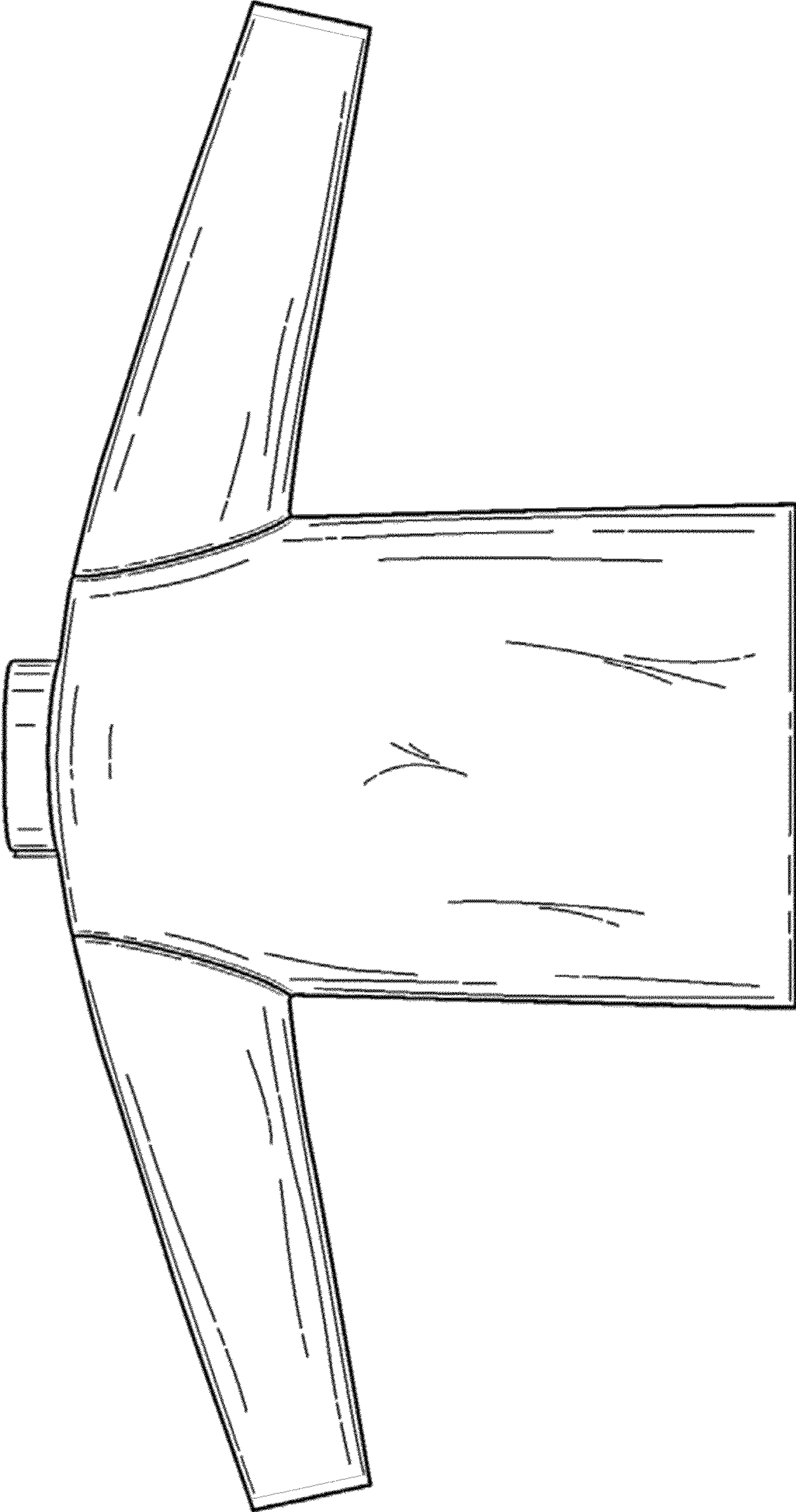

FIG. 3

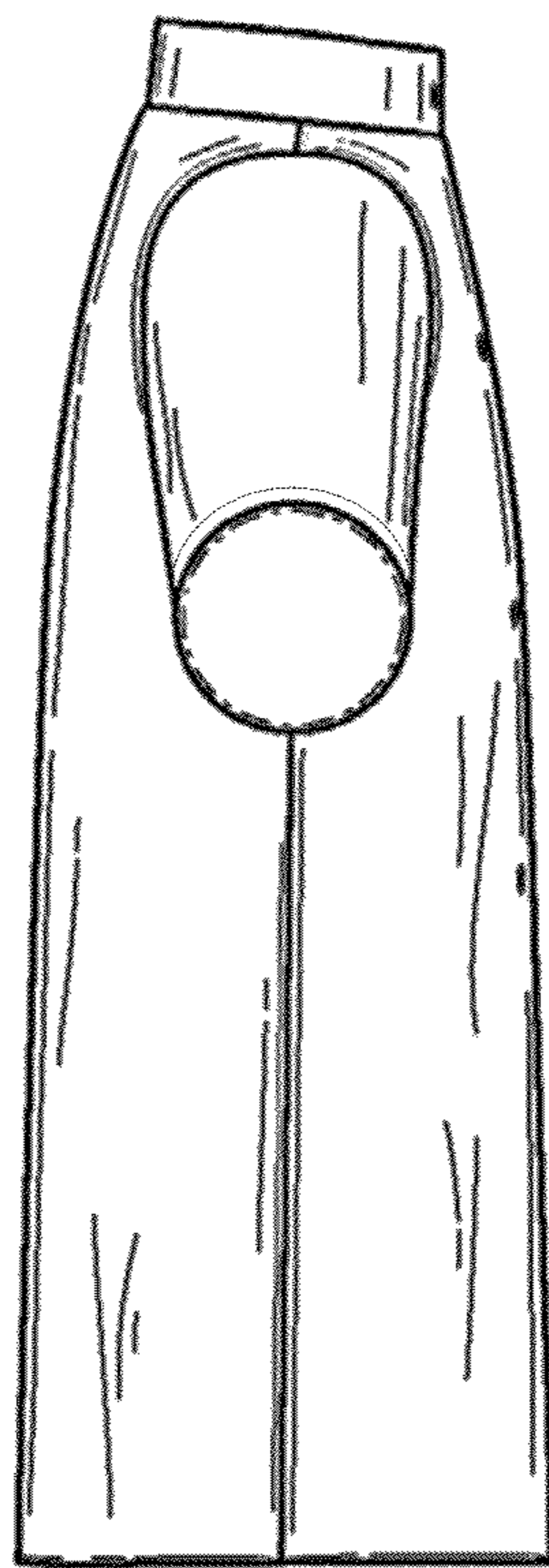

FIG. 4

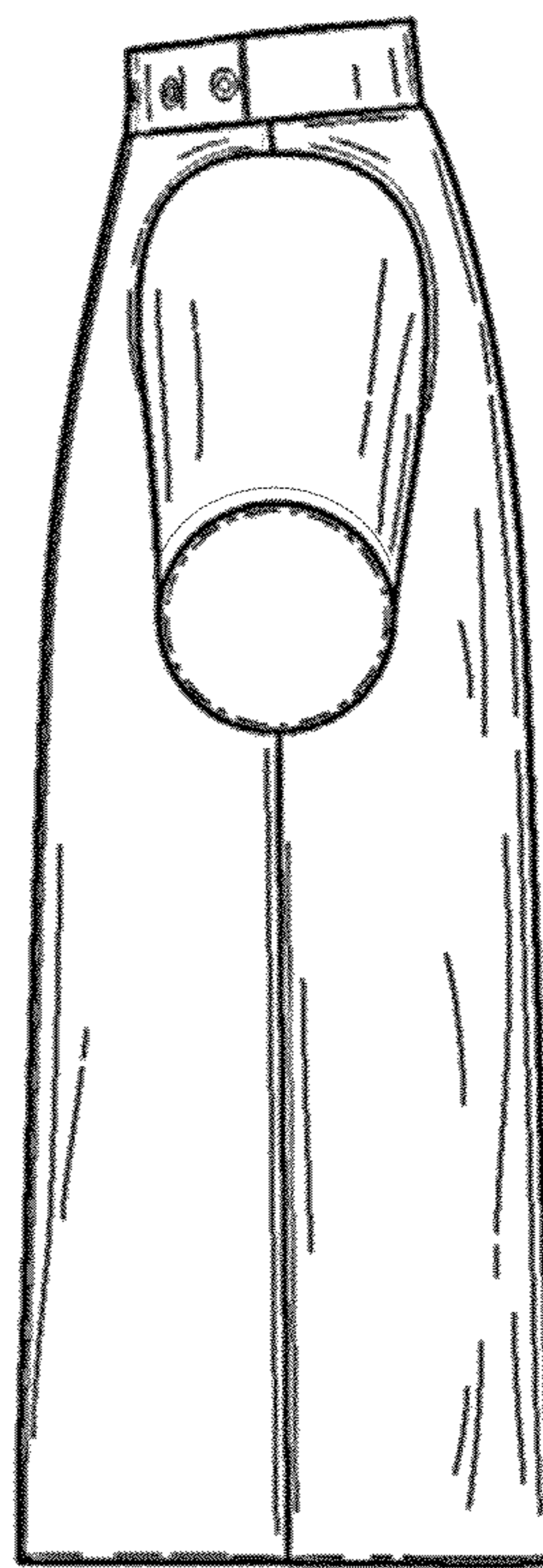

FIG. 5

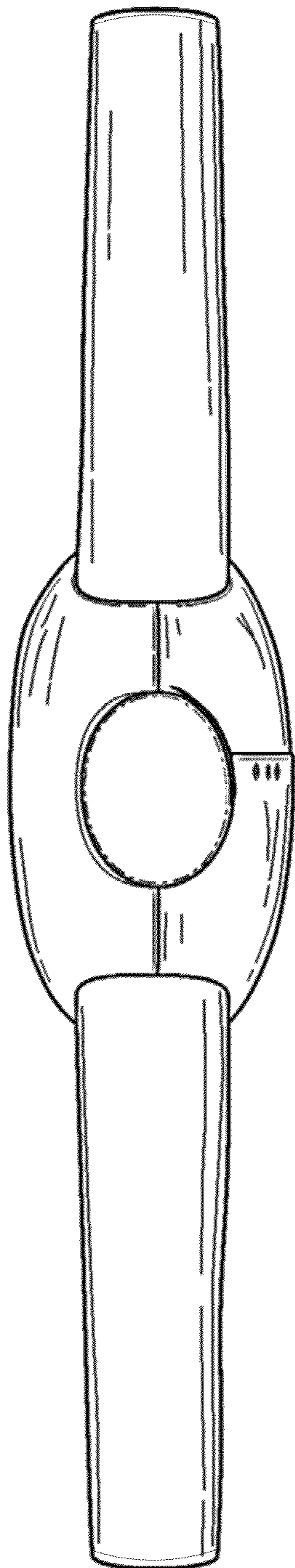

FIG. 6

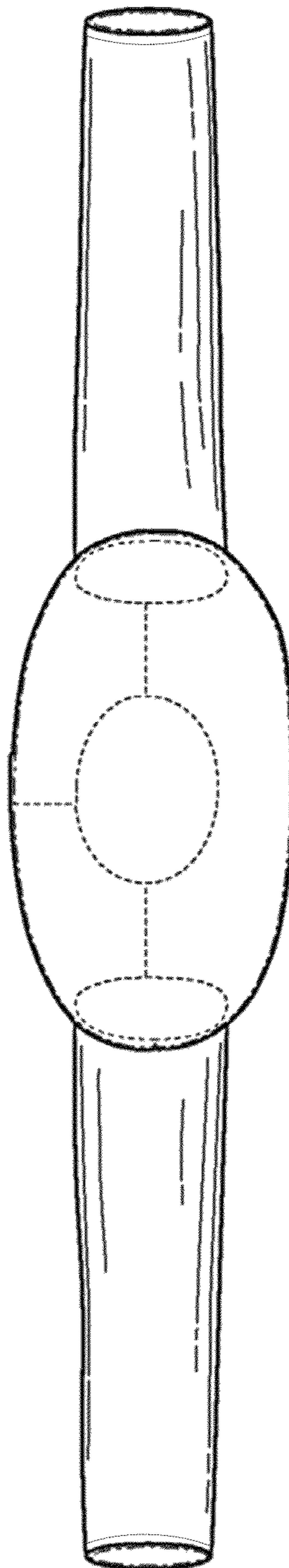

FIG. 7

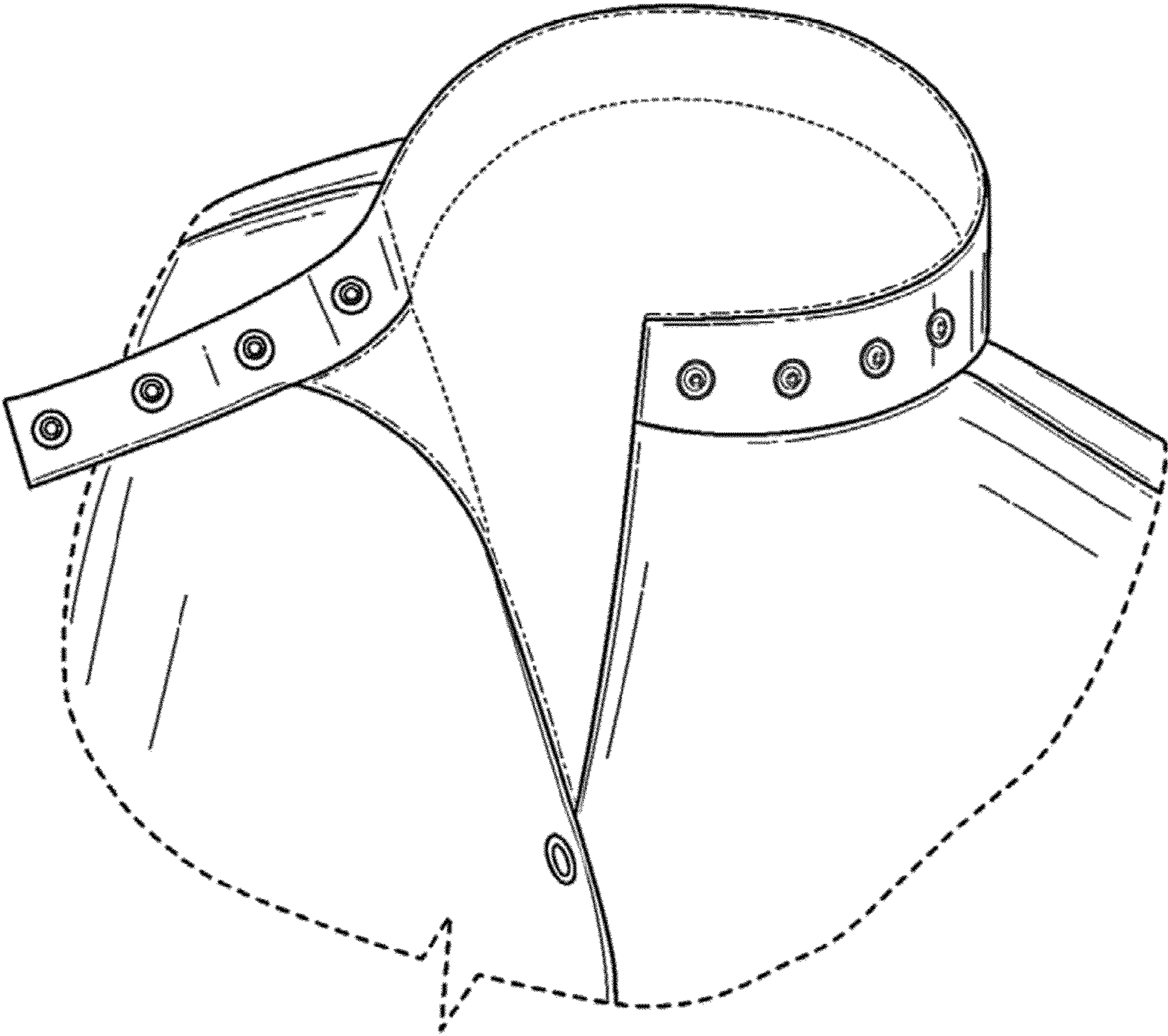

FIG. 8

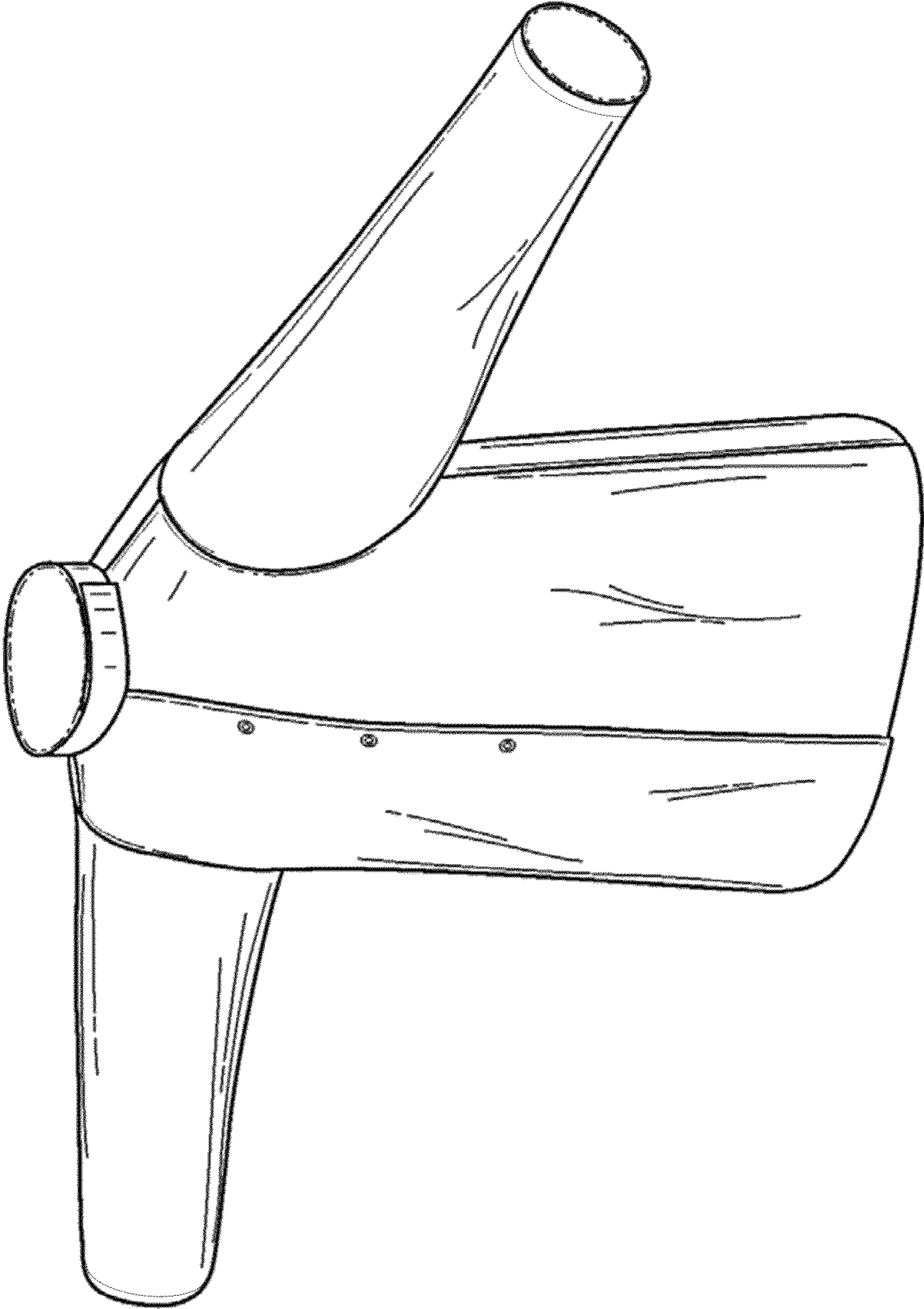

FIG. 9

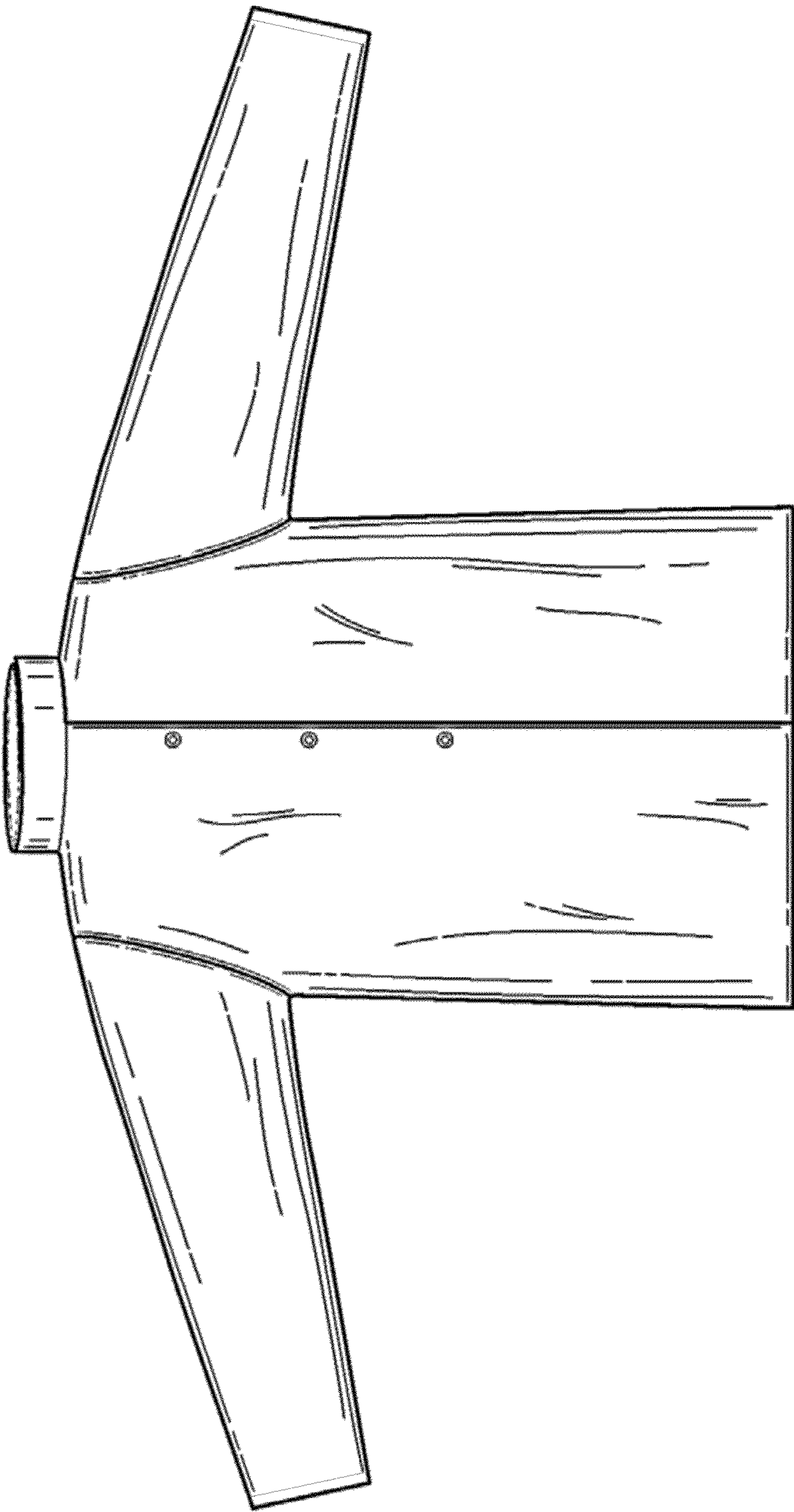

FIG. 10

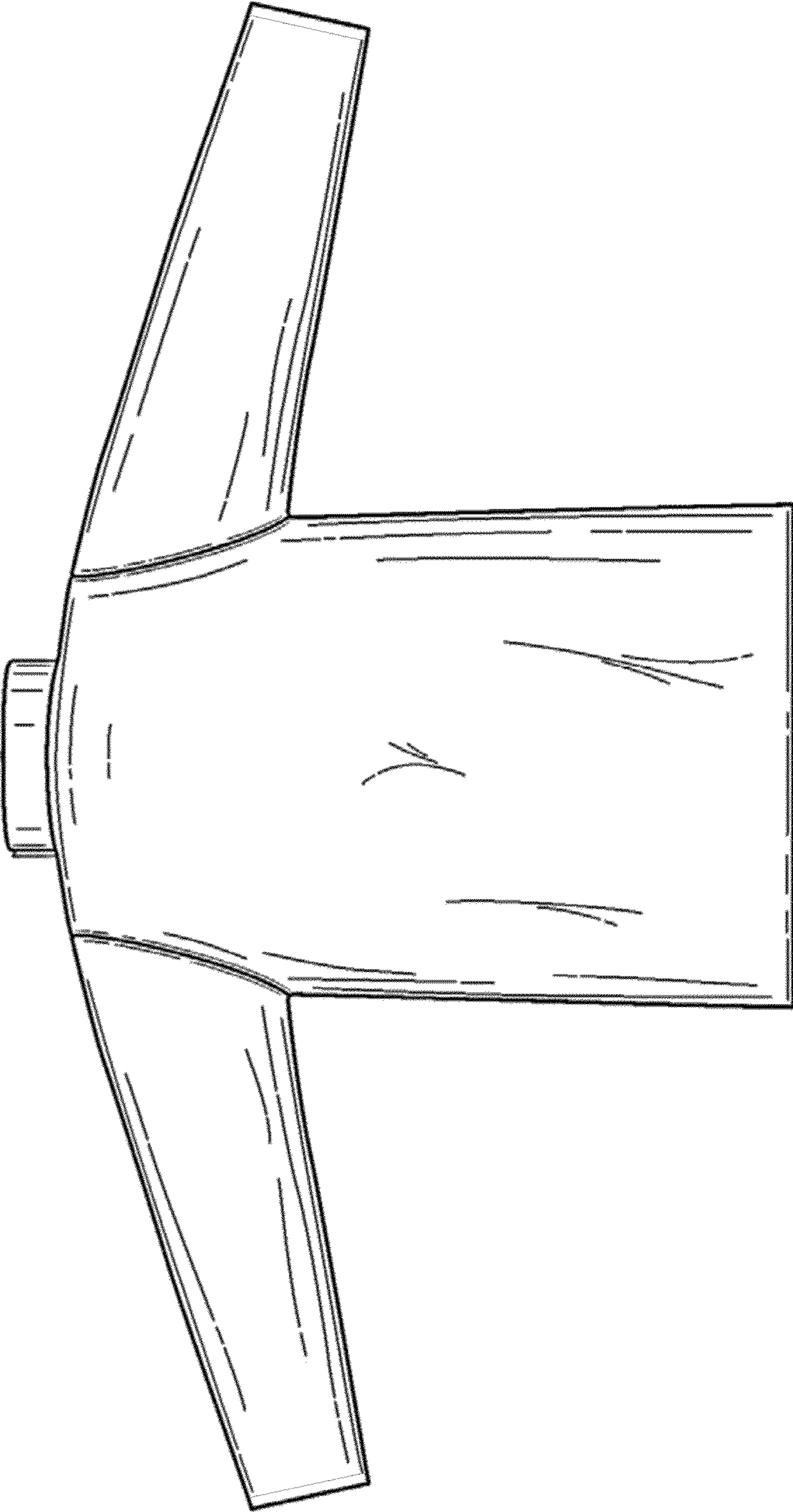

FIG. 11

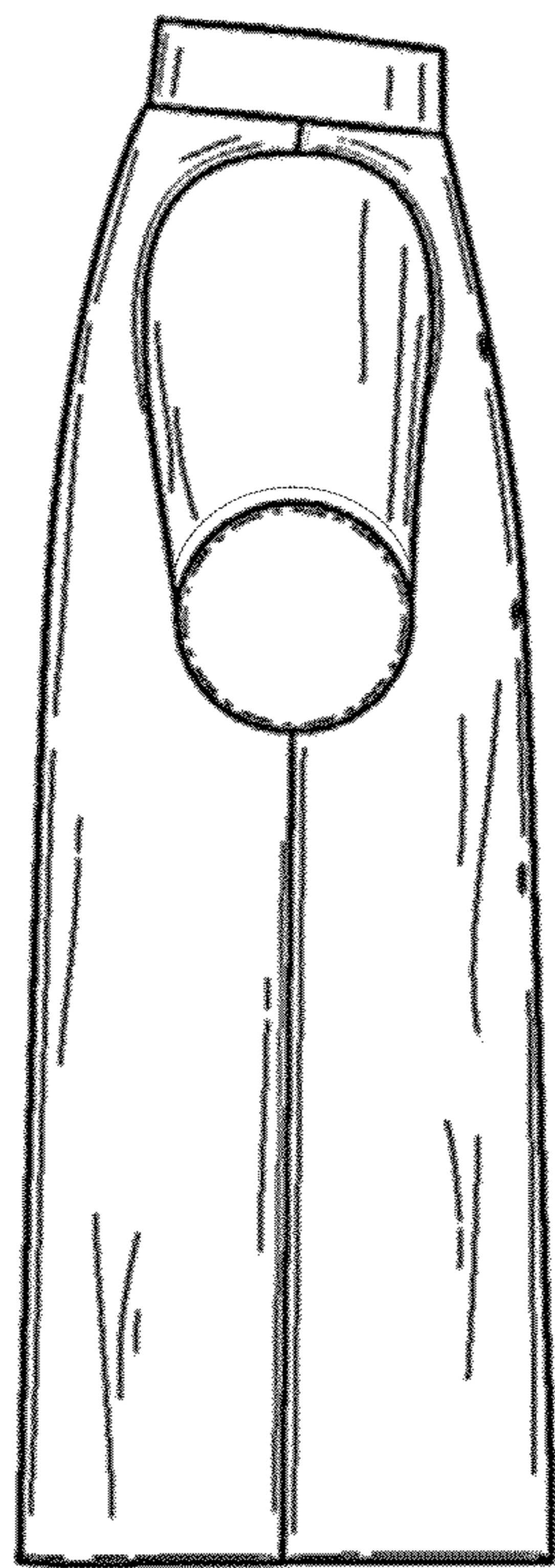

FIG. 12

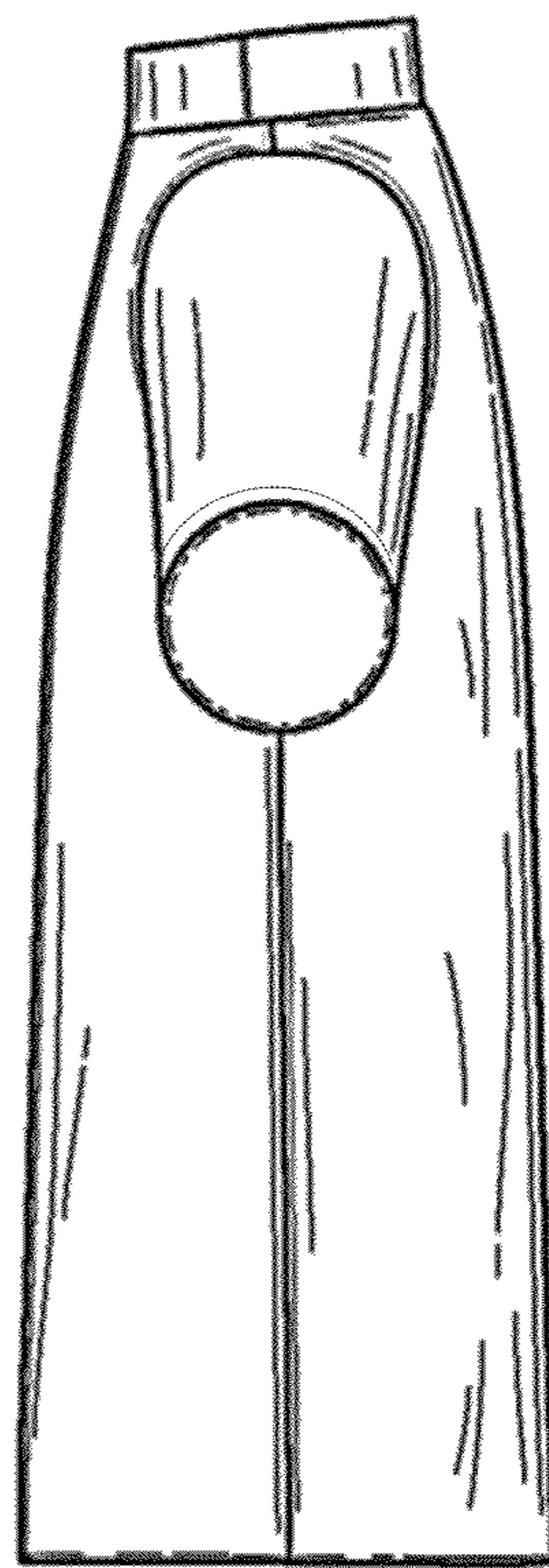

FIG. 13

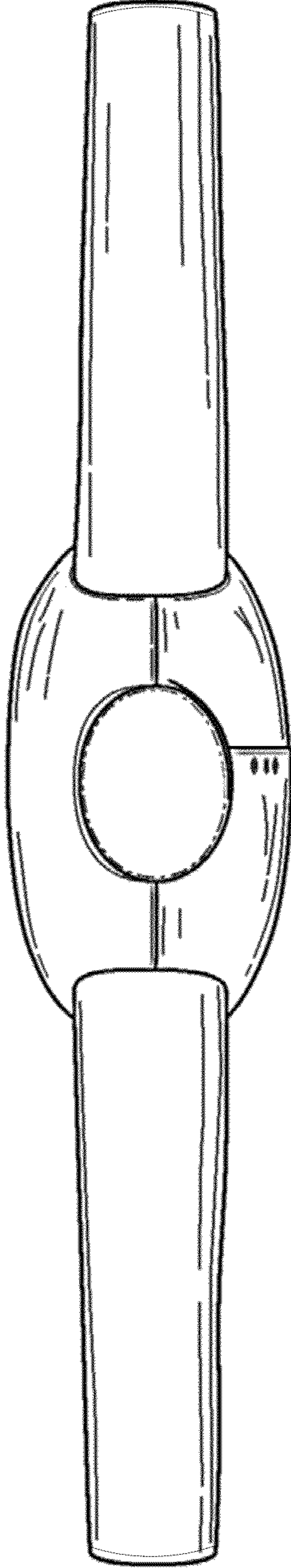

FIG. 14

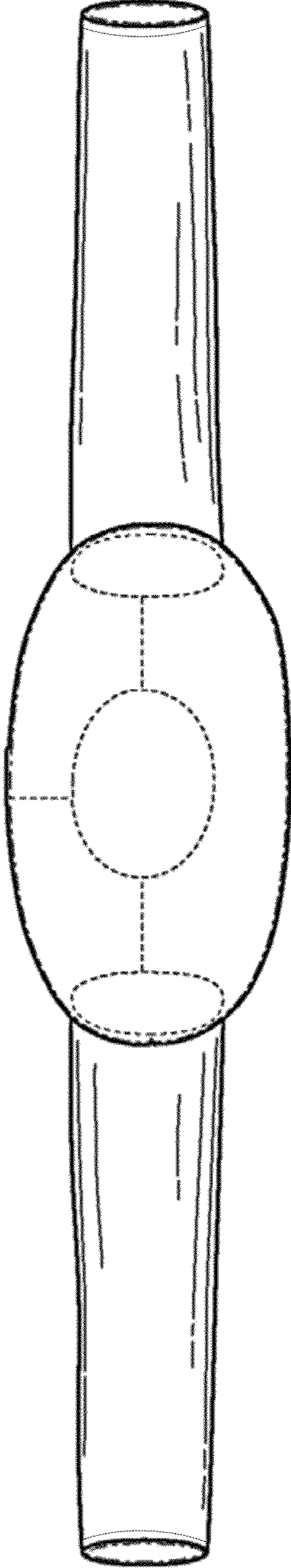

FIG. 15

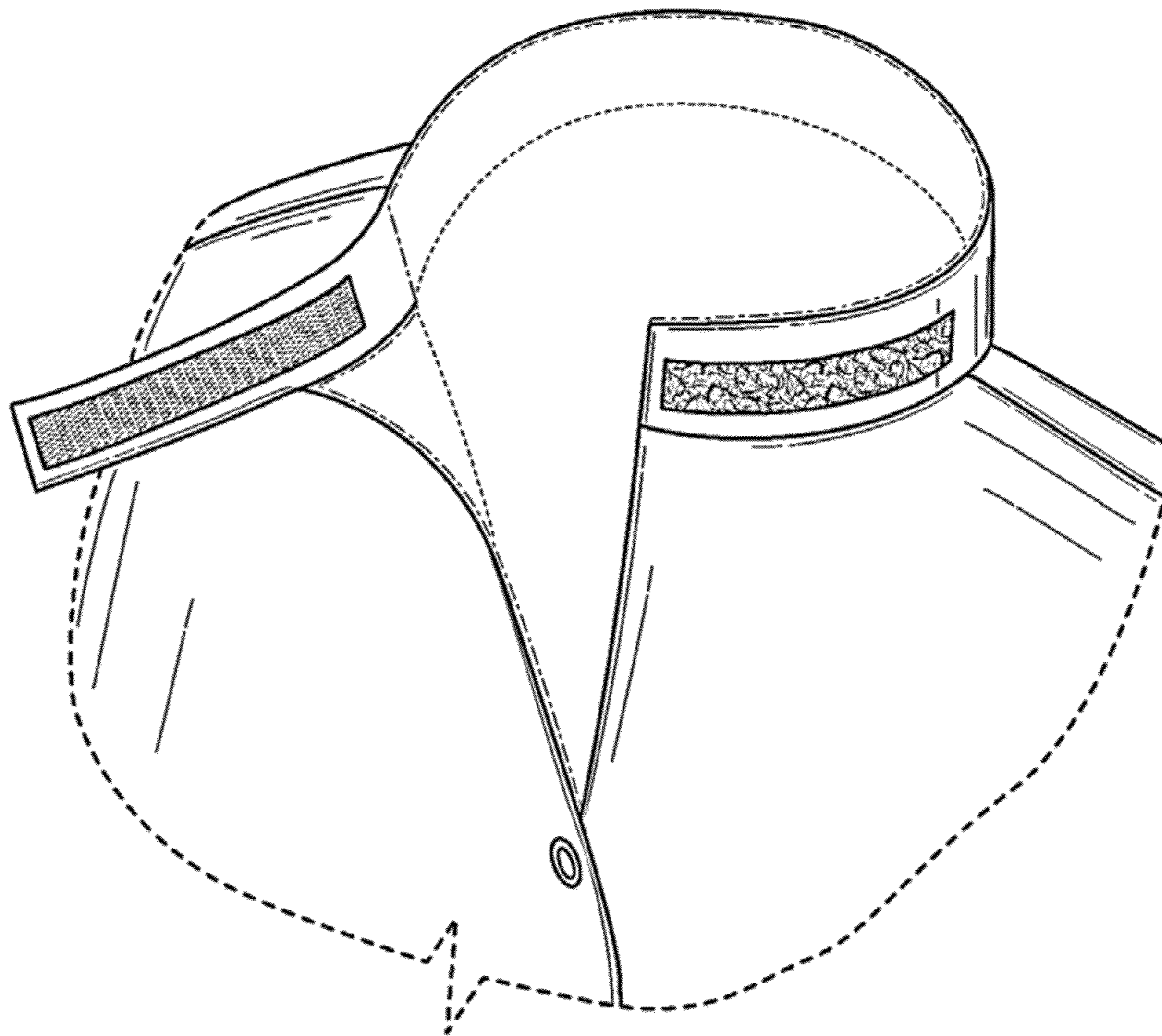

FIG. 16