



US00D743142S

(12) **United States Design Patent**  
**Munson**

(10) **Patent No.:** **US D743,142 S**  
(45) **Date of Patent:** **\*\* Nov. 17, 2015**

- (54) **CHILDREN'S GLOVE**
- (71) Applicant: **Drake Munson**, Salt Lake City, UT (US)
- (72) Inventor: **Drake Munson**, Salt Lake City, UT (US)
- (\*\*) Term: **14 Years**
- (21) Appl. No.: **29/486,818**
- (22) Filed: **Apr. 2, 2014**
- (51) **LOC (10) Cl.** ..... **02-06**
- (52) **U.S. Cl.**  
USPC ..... **D2/622**
- (58) **Field of Classification Search**  
USPC ..... D2/610, 611, 612, 613, 614, 615, 616,  
D2/617, 619, 622, 623; D28/63; D32/40,  
D32/41, 42, 43; 2/16, 18, 20, 158, 159, 160,  
2/161.1  
CPC ... A41D 13/081; A41D 19/082; A41D 19/00;  
A41D 19/0024; A41D 19/0037; A41D  
19/0041; A41D 19/0044; A41D 19/0048;  
A41F 1/06  
See application file for complete search history.

(56) **References Cited**

**U.S. PATENT DOCUMENTS**

D27,635	S	*	9/1897	Hoefler	.....	D2/622
1,254,578	A	*	1/1918	Carson	.....	2/158
1,280,421	A	*	10/1918	Diem	.....	2/158
2,279,100	A	*	4/1942	Goldsmith et al.	.....	401/7
2,315,888	A	*	4/1943	Wells	.....	2/158
2,695,999	A	*	12/1954	Arnold	.....	2/20
D307,198	S	*	4/1990	Rojko et al.	.....	D28/63
D307,199	S	*	4/1990	Rojko et al.	.....	D28/63
D369,634	S	*	5/1996	Green	.....	D21/754
D417,939	S	*	12/1999	Grinberg	.....	D2/622
D418,660	S	*	1/2000	Ke	.....	D2/622
D449,422	S	*	10/2001	Massie	.....	D2/614
D457,705	S	*	5/2002	Haslet et al.	.....	D32/40
D509,628	S	*	9/2005	Gilbert, Jr.	.....	D29/118
D551,397	S	*	9/2007	Van Haren	.....	D29/118
D552,801	S	*	10/2007	Van Trojen	.....	D29/120.1
D593,278	S	*	6/2009	Kimm	.....	D2/622
D594,158	S	*	6/2009	Lown et al.	.....	D29/113

7,584,519	B2	*	9/2009	Ouellette et al.	.....	15/227
D602,646	S	*	10/2009	Swartz et al.	.....	D29/119
D610,776	S	*	3/2010	Walker	.....	D2/622
D653,428	S	*	2/2012	Ramos	.....	D2/622
D661,401	S	*	6/2012	Lavigne	.....	D24/190
8,230,523	B2	*	7/2012	Chareyron	.....	2/161.6
D684,747	S	*	6/2013	Jack	.....	D2/622
D714,496	S	*	9/2014	Lown et al.	.....	D29/118
2010/0186139	A1		7/2010	Kurtz		
2012/0240301	A1	*	9/2012	Gustafsson	.....	2/16
2013/0185842	A1	*	7/2013	Bonner et al.	.....	2/158

\* cited by examiner

*Primary Examiner* — Karen E. Eldridge Powers

*Assistant Examiner* — Jasmine Mlinarcik

(74) *Attorney, Agent, or Firm* — Clayton, Howarth & Cannon, P.C.

(57) **CLAIM**

I claim the ornamental design for a children's glove, as shown and described.

**DESCRIPTION**

FIG. 1 is a left side elevation view of a first embodiment of a children's glove;  
 FIG. 2 is a front elevation view thereof;  
 FIG. 3 is a top plan view thereof;  
 FIG. 4 is a perspective view thereof;  
 FIG. 5 is a bottom plan view thereof;  
 FIG. 6 is a rear elevation view thereof;  
 FIG. 7 is a right side elevation view thereof;  
 FIG. 8 is a left side elevation view of a second embodiment of a children's glove;  
 FIG. 9 is a front elevation view of the embodiment of FIG. 8;  
 FIG. 10 is a top plan view thereof;  
 FIG. 11 is a perspective view thereof;  
 FIG. 12 is a bottom plan view thereof;  
 FIG. 13 is a rear elevation view thereof; and,  
 FIG. 14 is a right side elevation view thereof.  
 The broken lines illustrate features of the article of manufacture that form no part of the claimed design.

**1 Claim, 2 Drawing Sheets**

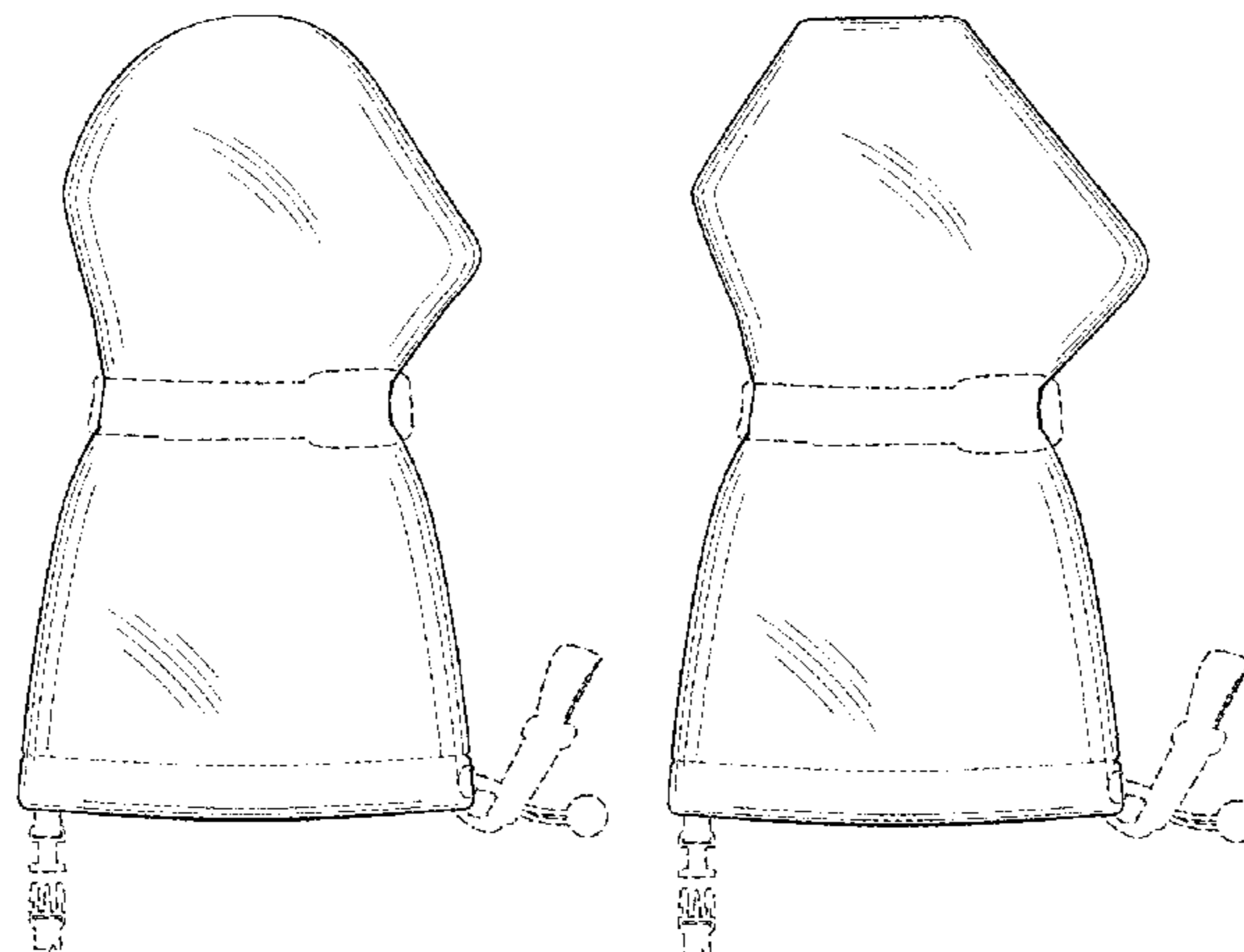

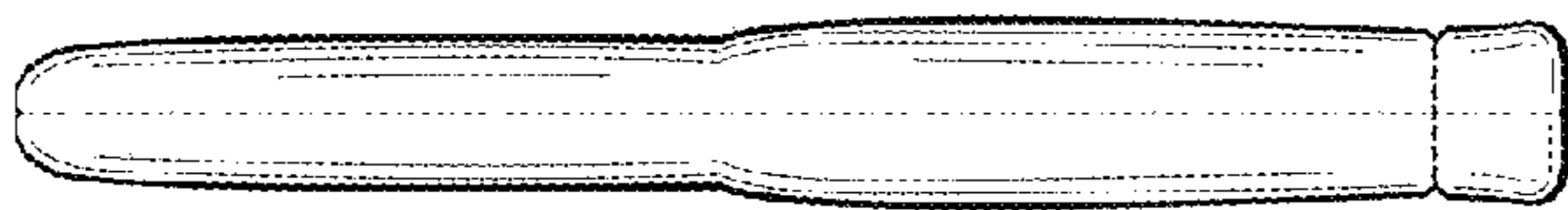

FIG. 1

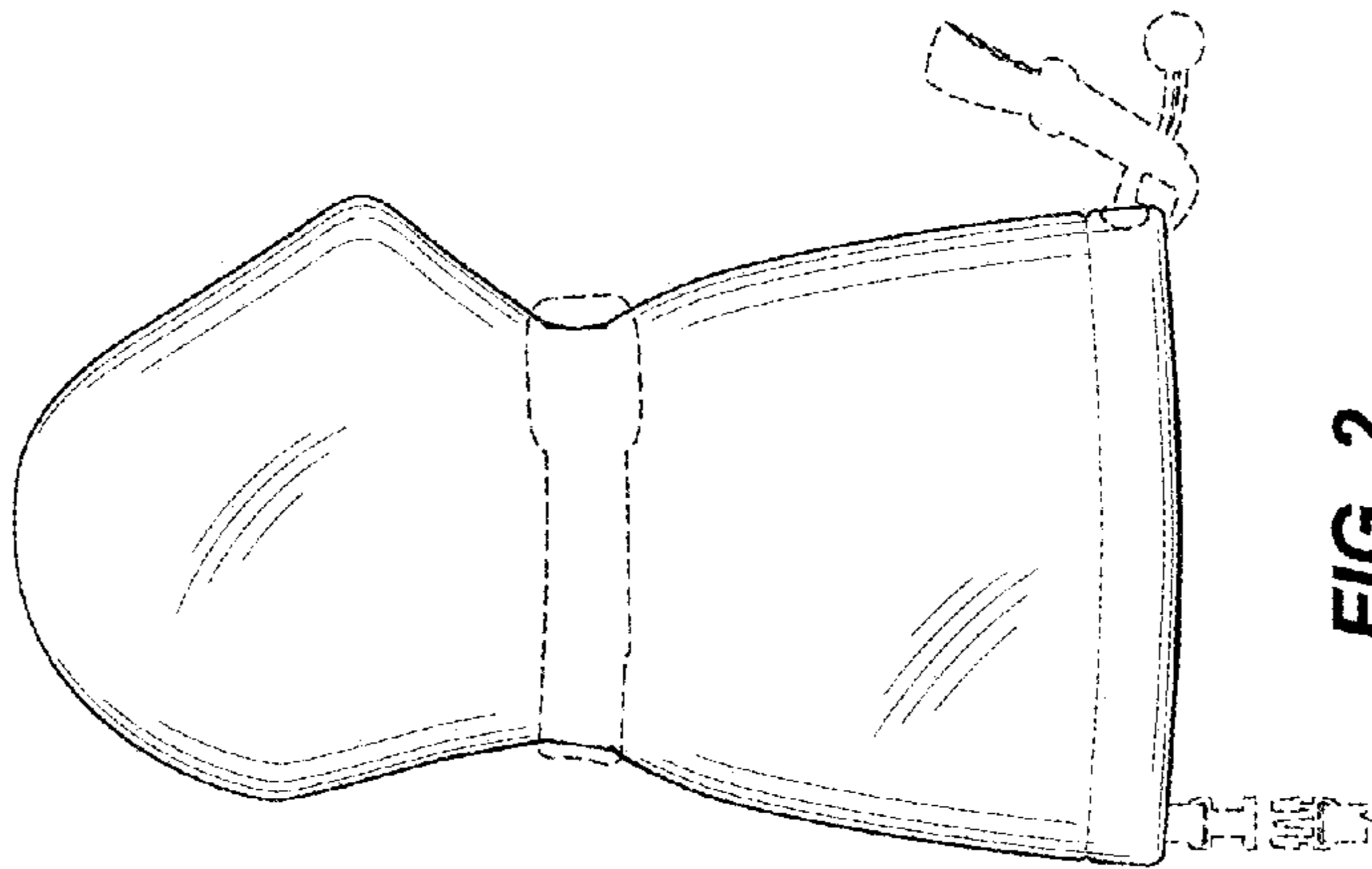

FIG. 2

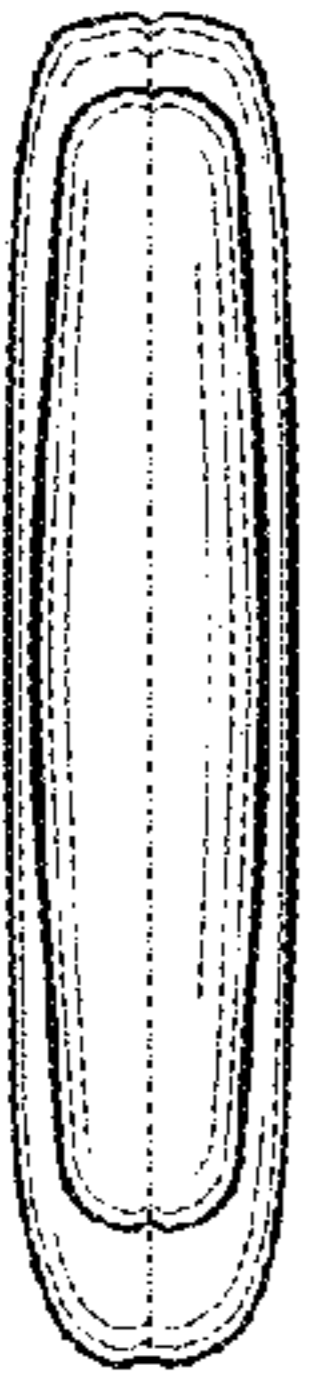

FIG. 3

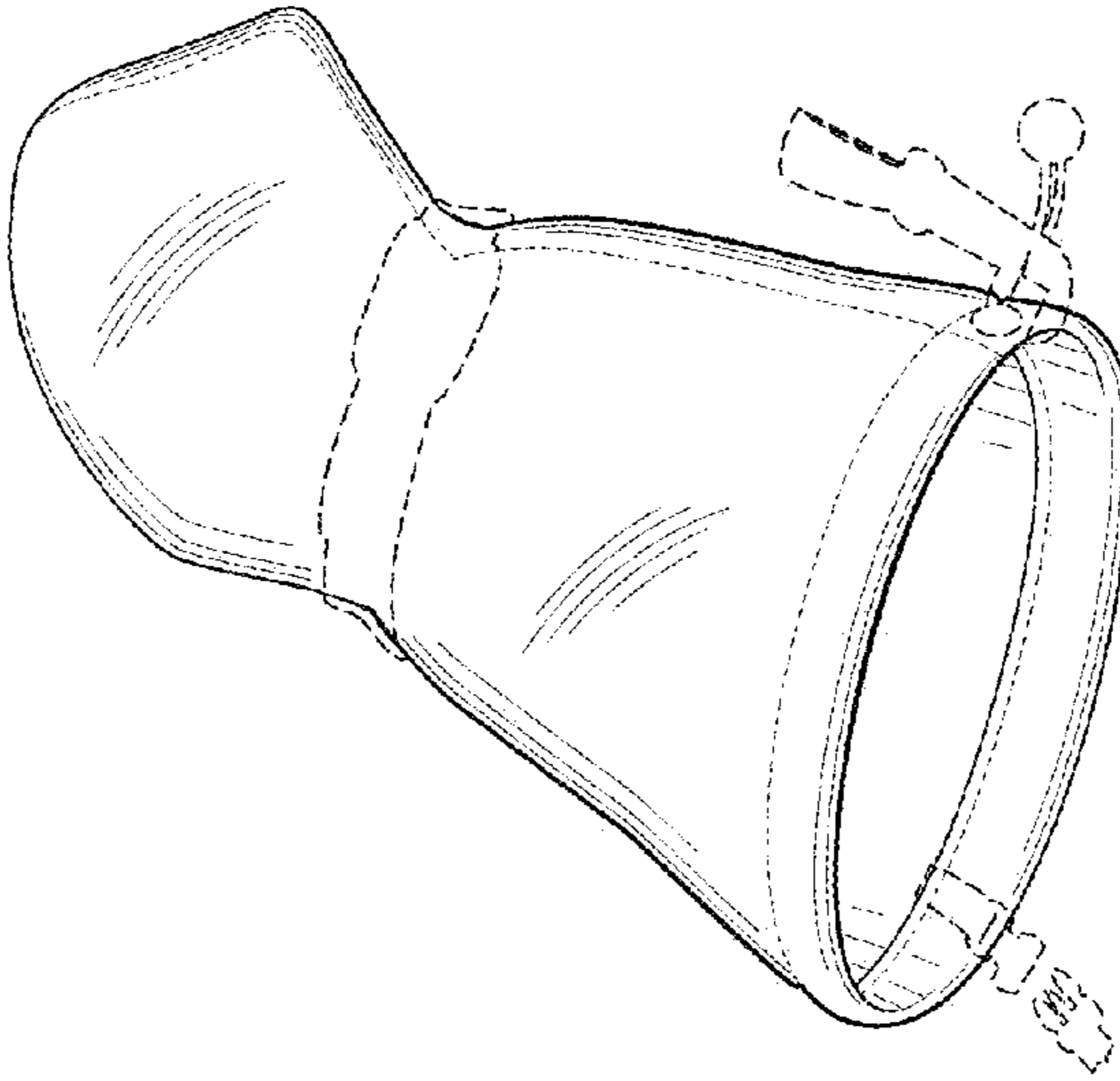

FIG. 4

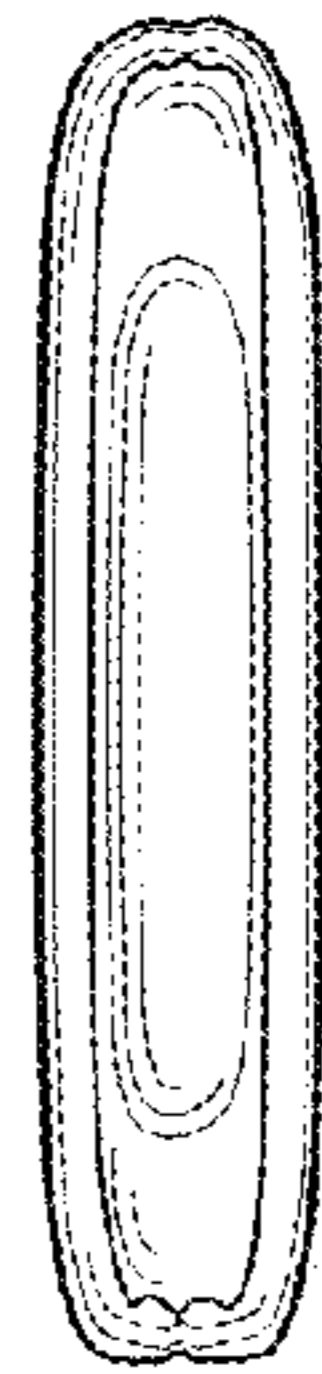

FIG. 5

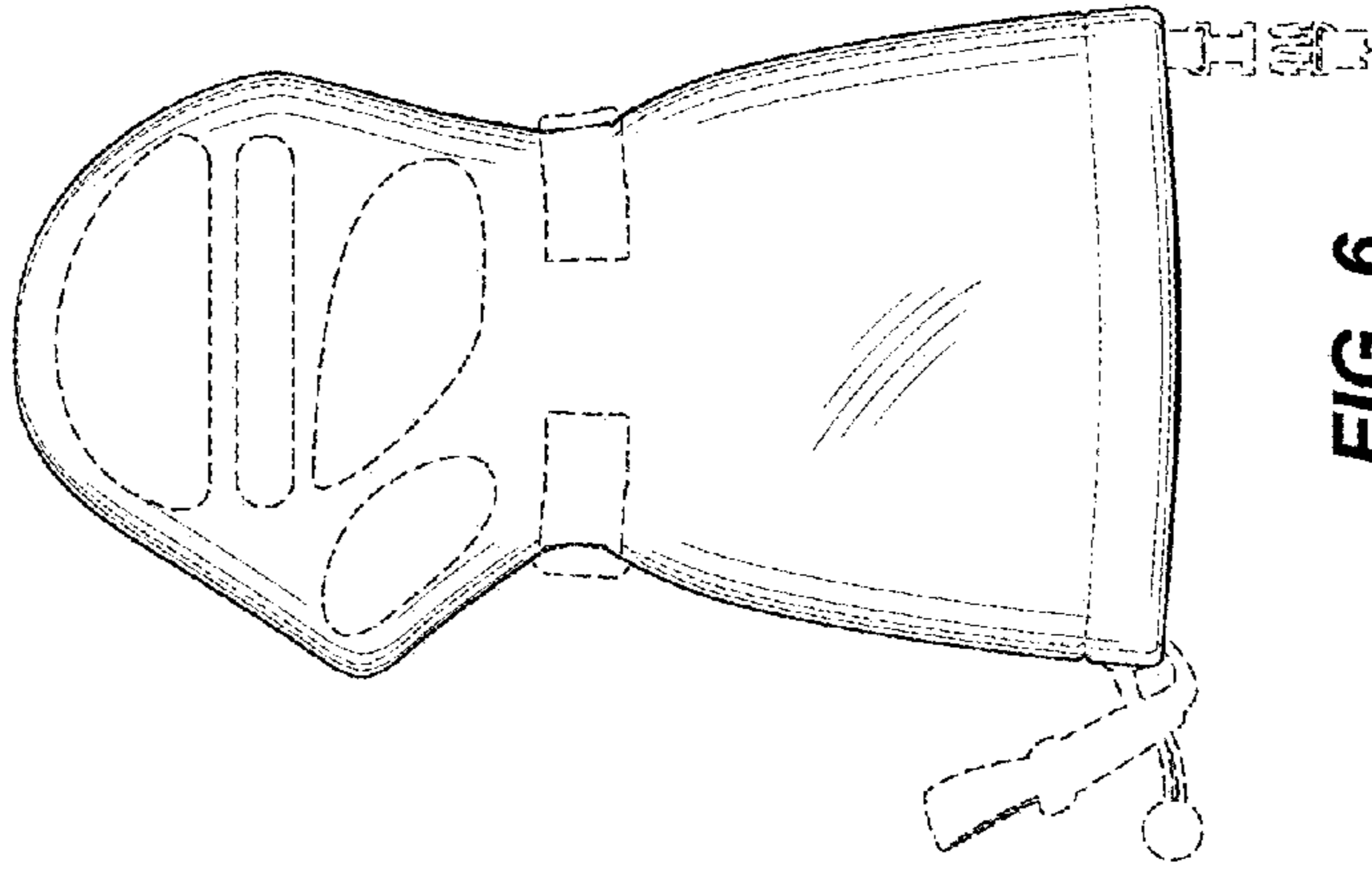

FIG. 6

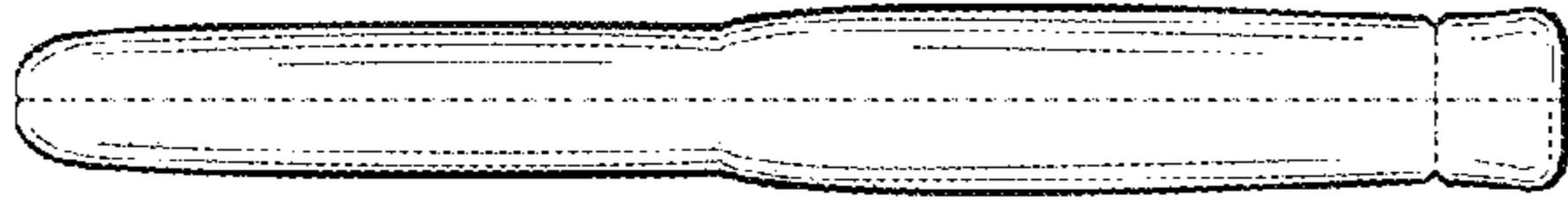

FIG. 7

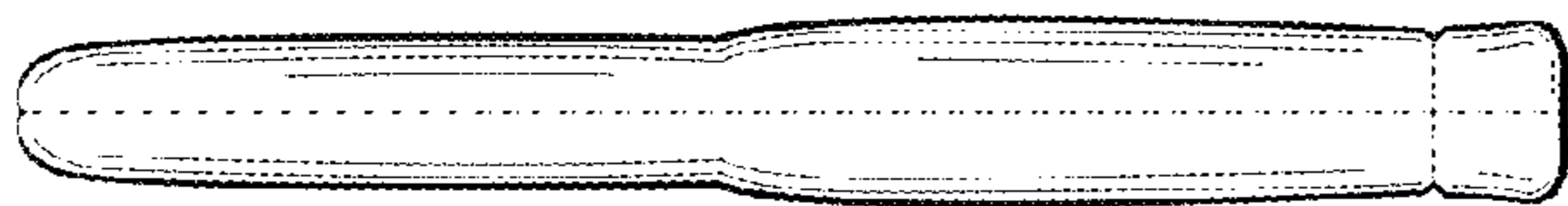

FIG. 8

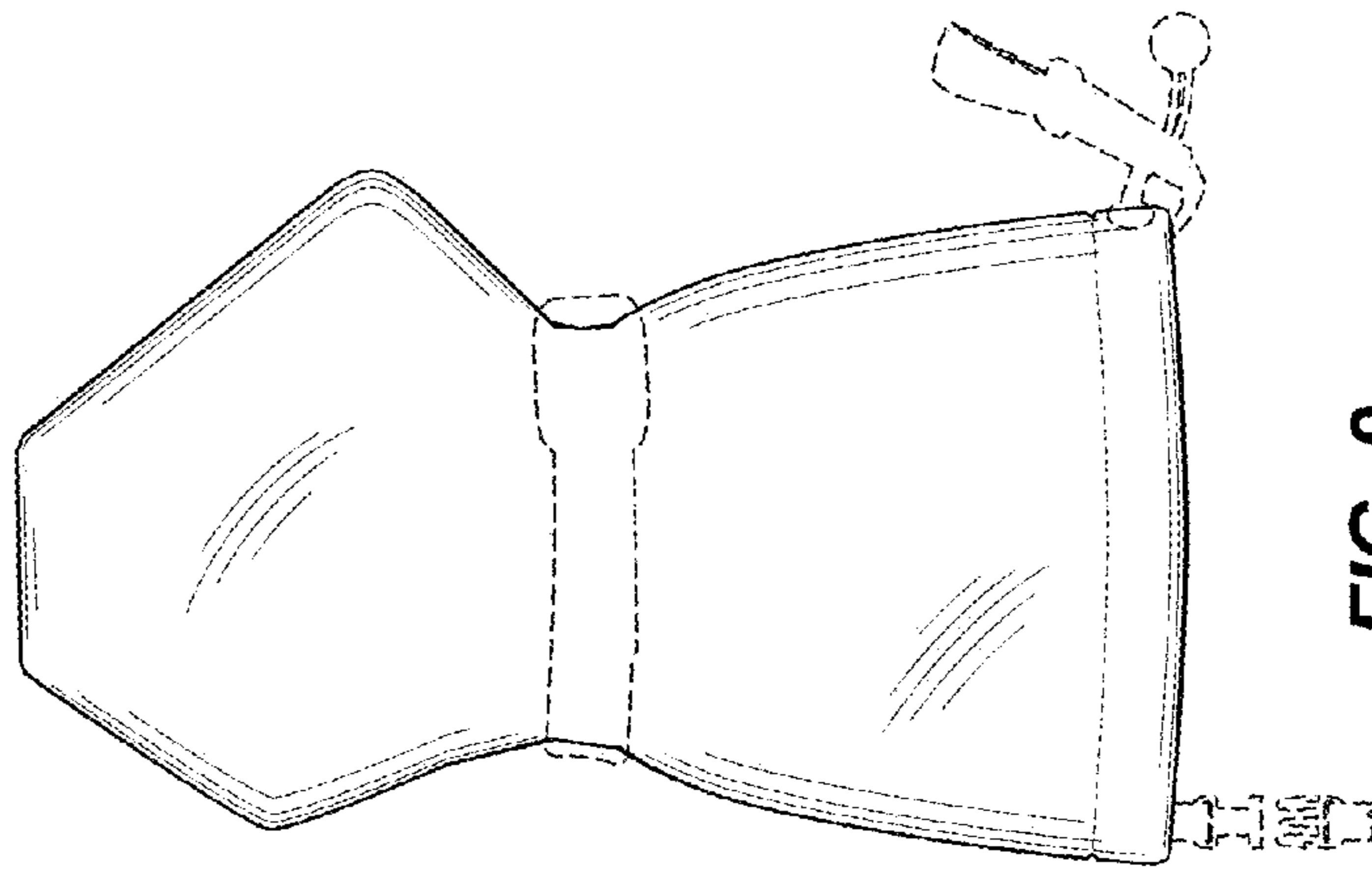

FIG. 9

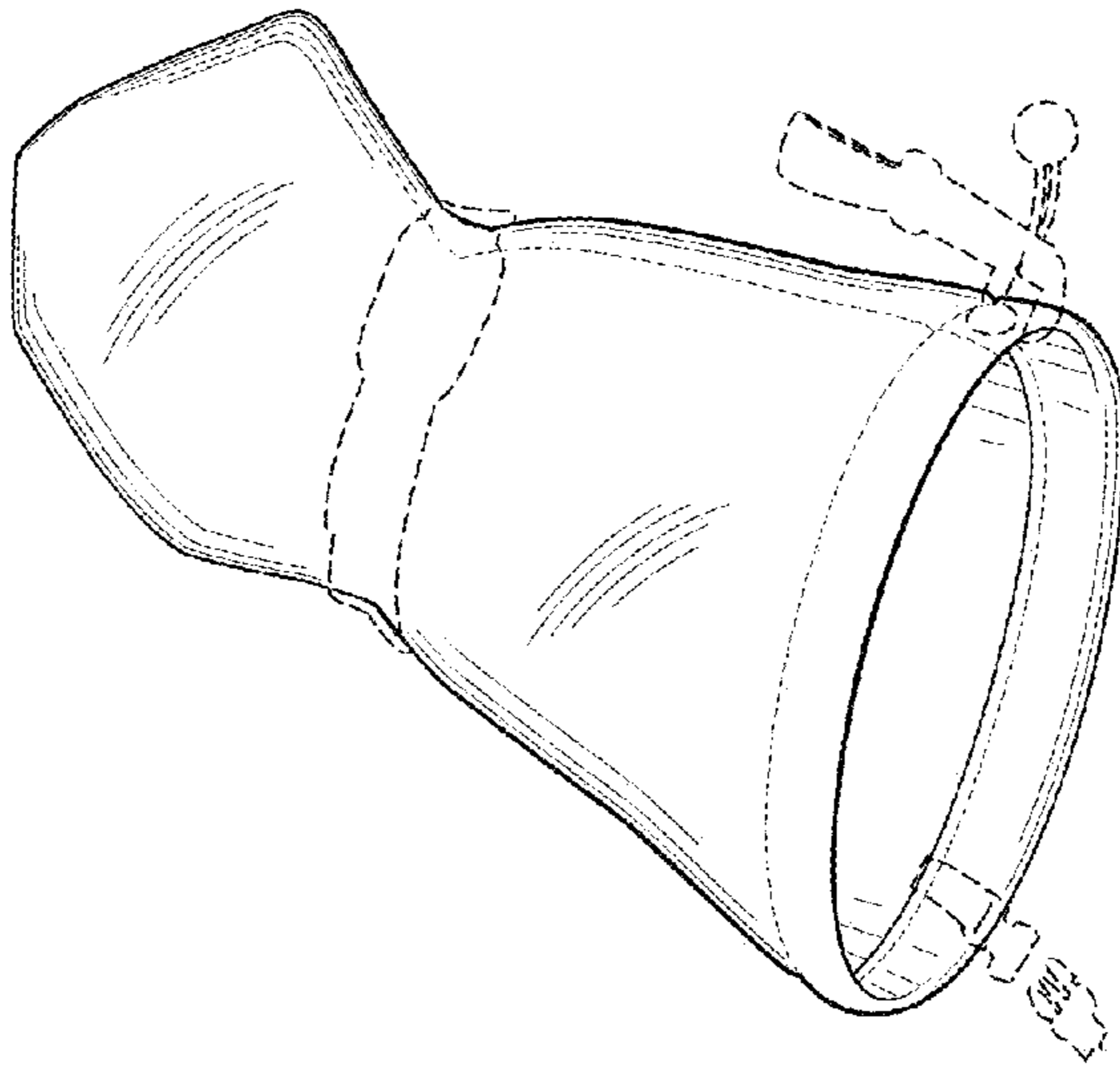

FIG. 11

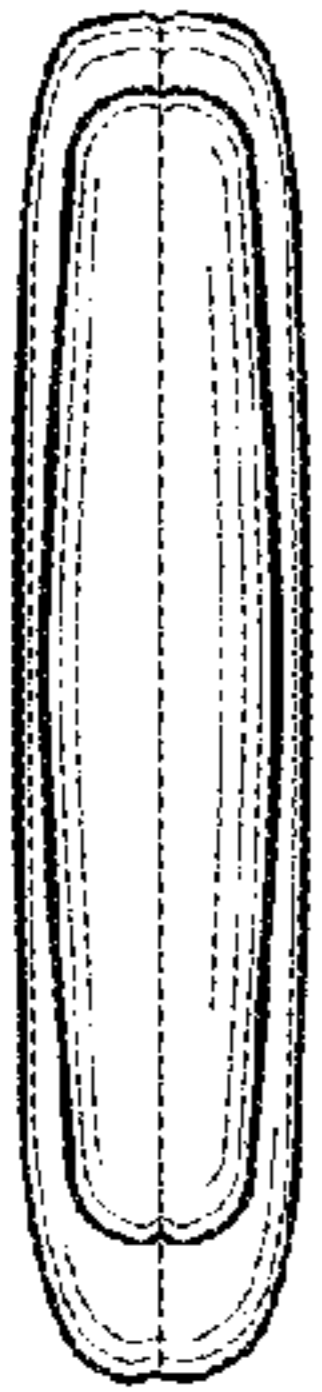

FIG. 10



FIG. 12

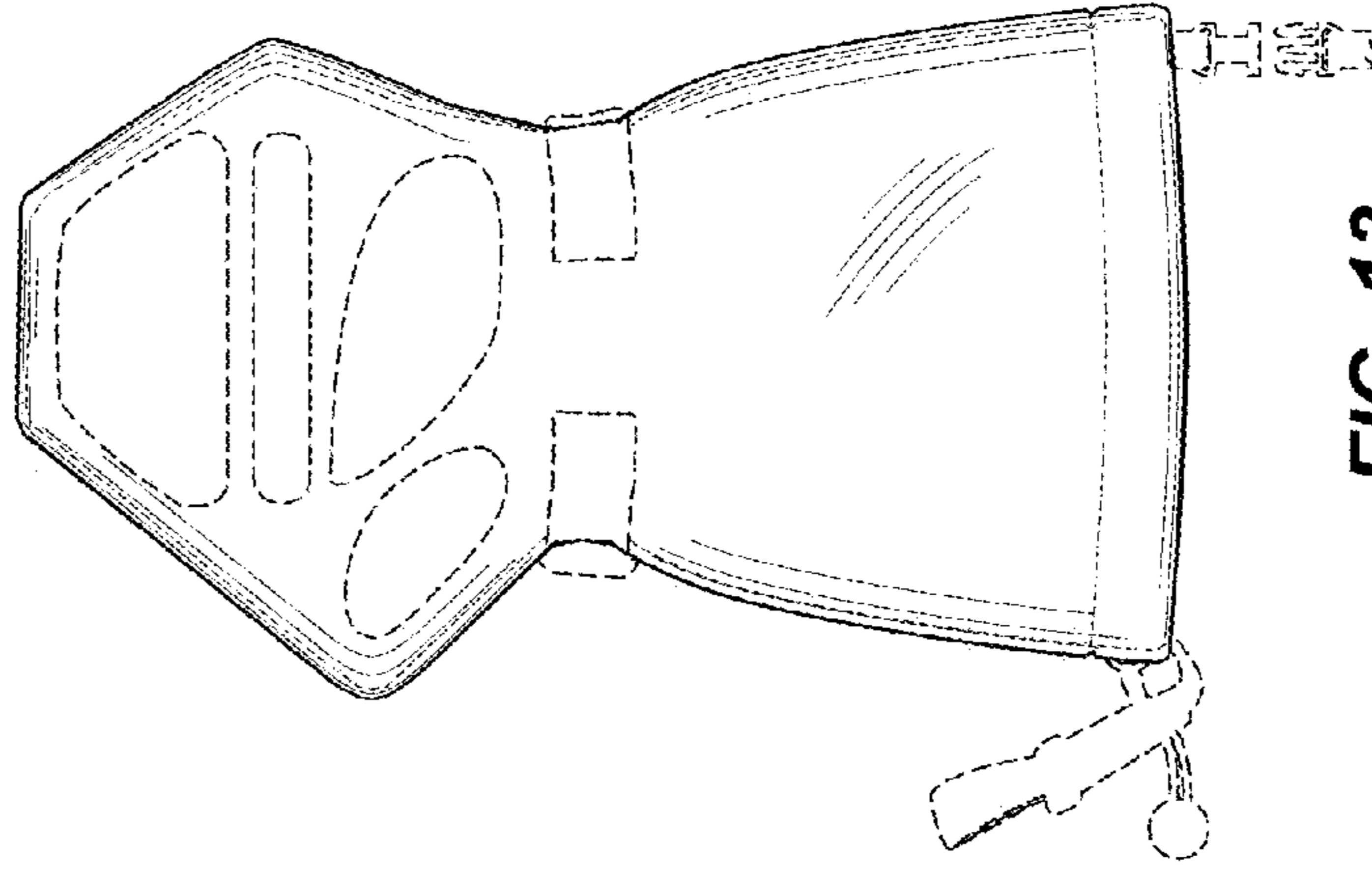

FIG. 13

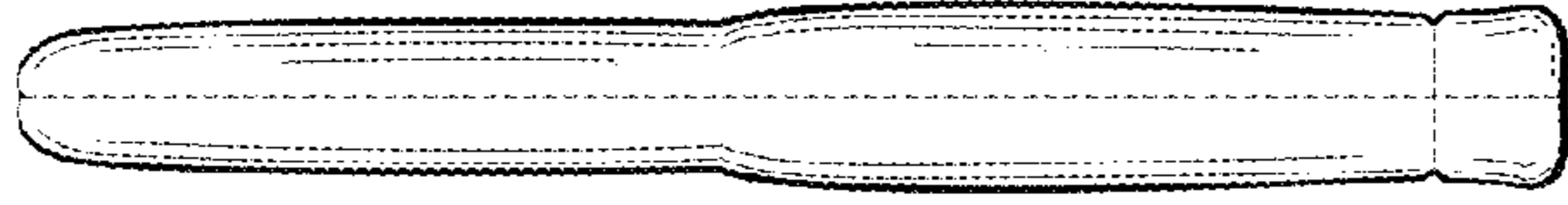

FIG. 14