



US00D742848S

(12) **United States Design Patent**  
**Hachiya**

(10) **Patent No.:** **US D742,848 S**

(45) **Date of Patent:** **\*\* Nov. 10, 2015**

(54) **PORTABLE TERMINAL**

(71) Applicant: **KYOCERA CORPORATION**, Kyoto (JP)

(72) Inventor: **Hidetoshi Hachiya**, Osaka (JP)

(73) Assignee: **KYOCERA Corporation**, Kyoto (JP)

(\*\*) Term: **14 Years**

(21) Appl. No.: **29/484,913**

(22) Filed: **Mar. 13, 2014**

(30) **Foreign Application Priority Data**

Dec. 19, 2013 (JP) ..... 2013-029873

(51) **LOC (10) Cl.** ..... **14-03**

(52) **U.S. Cl.**  
USPC ..... **D14/138 G**

(58) **Field of Classification Search**  
USPC ..... D14/138 G, 138 AC, 138 AD, 138 R,  
D14/203.1, 203.3, 203.5, 203.7, 218, 248,  
D14/257, 250, 341, 441, 443, 496;  
D21/517, 329, 331; D13/168; D10/65,  
D10/70; 455/556.1, 556.2, 575.1, 575.3,  
455/575.4, 566; 379/433.01, 433.04;  
361/679.3, 679.56

CPC ... H04M 1/02; H04M 1/0202; H04M 1/0235;  
H04M 1/0237; H04M 1/0239; H04M 2250/22

See application file for complete search history.

(56) **References Cited**

**U.S. PATENT DOCUMENTS**

D593,057 S \* 5/2009 Harju ..... D14/138 AD  
D603,355 S \* 11/2009 Tkachuk ..... D14/138 AD  
D606,506 S \* 12/2009 Choi et al. .... D14/138 AD  
D622,714 S \* 8/2010 He ..... D14/248  
D645,441 S \* 9/2011 Choe et al. .... D14/138 G  
D652,813 S \* 1/2012 Song et al. .... D14/138 G  
D654,460 S \* 2/2012 Kim et al. .... D14/138 G

D686,586 S \* 7/2013 Cho et al. .... D14/138 G  
D696,641 S \* 12/2013 Cho ..... D14/138 G  
D698,332 S \* 1/2014 Ryu ..... D14/138 G  
D702,205 S \* 4/2014 Joung et al. .... D14/138 G  
D703,178 S \* 4/2014 Park et al. .... D14/138 G  
D707,195 S \* 6/2014 Kim et al. .... D14/138 G  
D709,472 S \* 7/2014 Seo et al. .... D14/138 G  
D711,335 S \* 8/2014 Kim ..... D14/138 G  
D713,368 S \* 9/2014 Kim et al. .... D14/138 G  
D714,752 S \* 10/2014 Im et al. .... D14/138 G  
D715,246 S \* 10/2014 Oh ..... D14/138 G  
D717,266 S \* 11/2014 Chung et al. .... D14/138 G  
D719,124 S \* 12/2014 Kim et al. .... D14/138 AD  
D720,318 S \* 12/2014 Kim et al. .... D14/138 G

(Continued)

**OTHER PUBLICATIONS**

Samsung I8530 Galaxy Beam, announced Feb. 2012, [online], [site visited Jun. 26, 2015]. Available from Internet, <URL: [http://www.gsmarena.com/samsung\\_i8530\\_galaxy\\_beam-4566.php](http://www.gsmarena.com/samsung_i8530_galaxy_beam-4566.php)>.\*

(Continued)

*Primary Examiner* — Eric Goodman

*Assistant Examiner* — Sanjeev Paul

(74) *Attorney, Agent, or Firm* — Studebaker & Brackett PC

(57) **CLAIM**

The ornamental design for portable terminal, as shown and described.

**DESCRIPTION**

FIG. 1 is a front perspective view of a portable terminal showing my new design;

FIG. 2 is a rear perspective view thereof;

FIG. 3 is a front view thereof;

FIG. 4 is a rear view thereof;

FIG. 5 is a left side view thereof;

FIG. 6 is a right side view thereof;

FIG. 7 is a top plan view thereof; and,

FIG. 8 is a bottom view thereof.

**1 Claim, 6 Drawing Sheets**

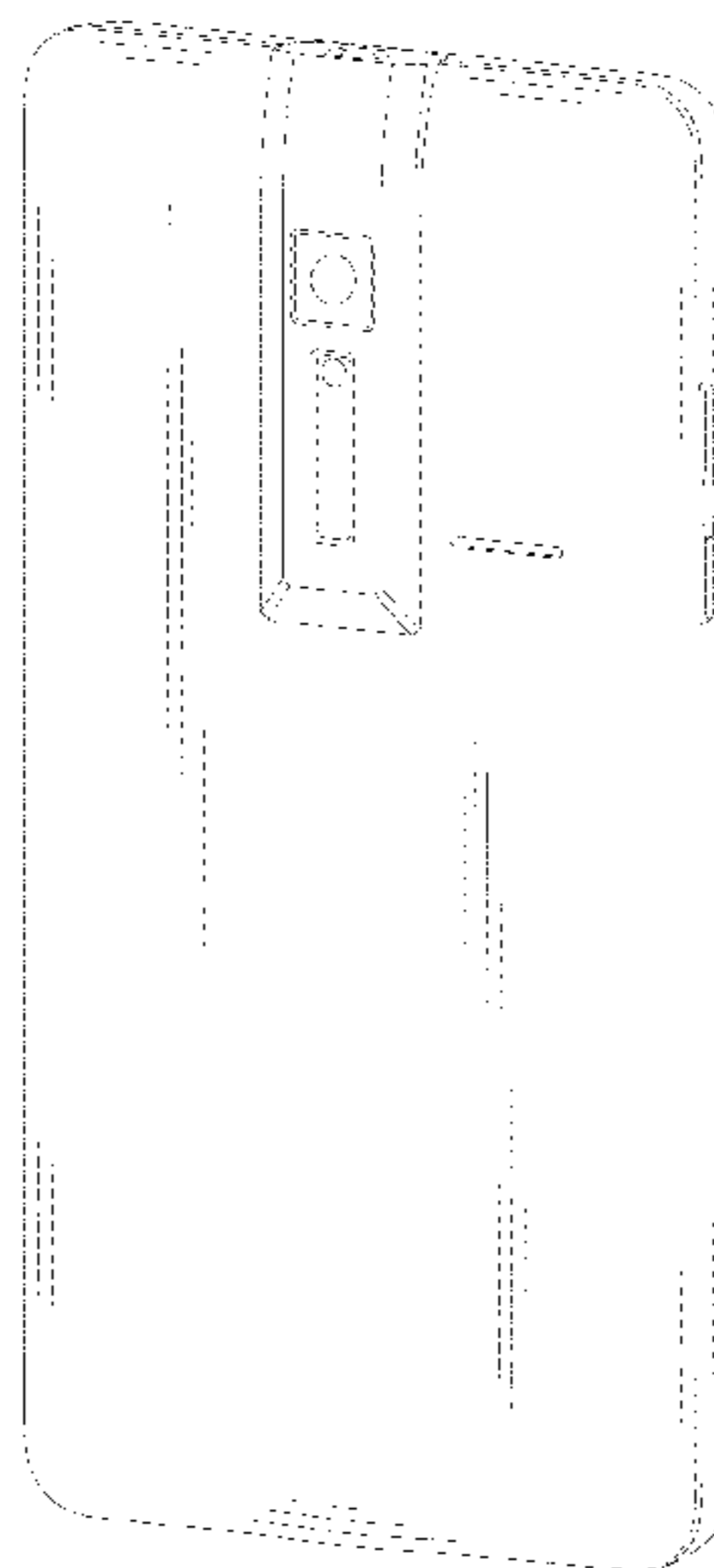
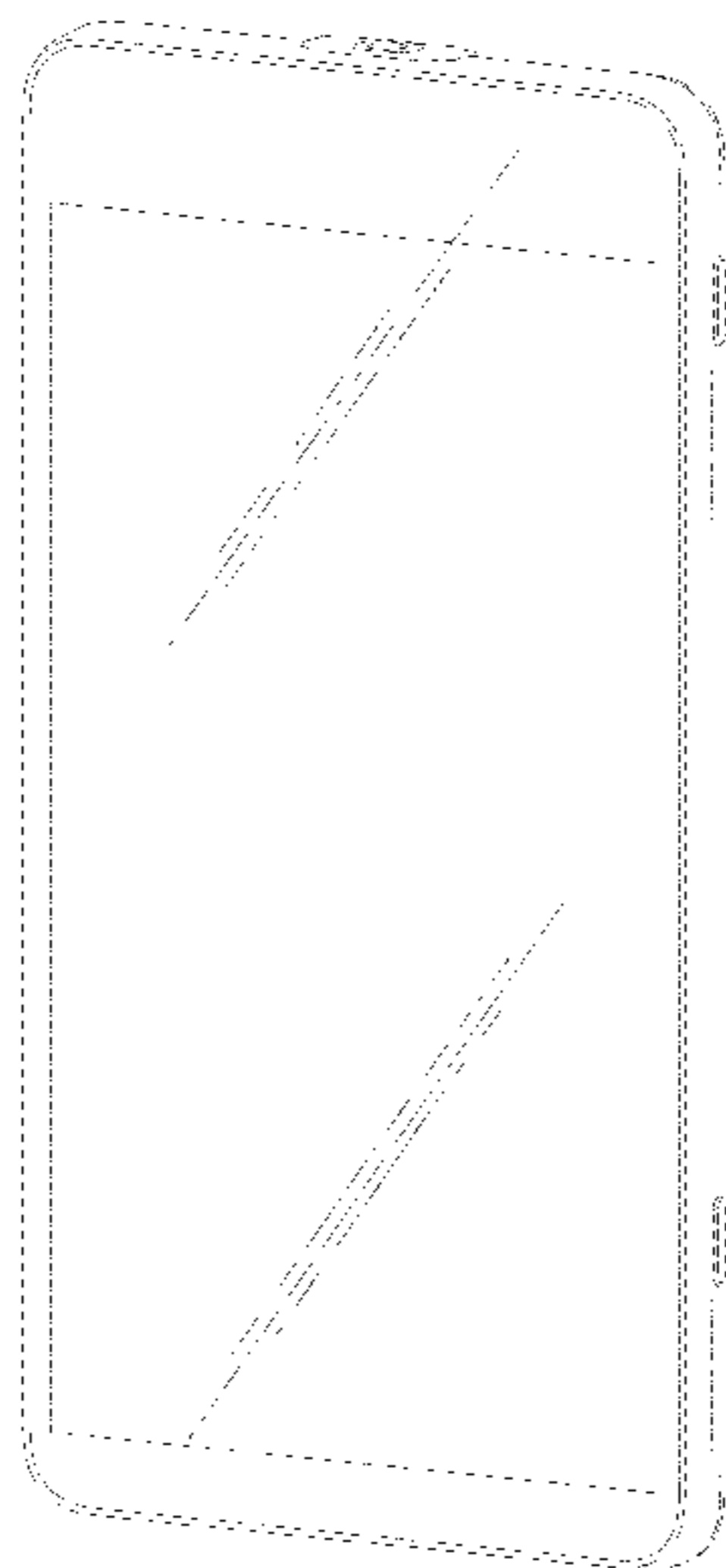

(56)

**References Cited**

U.S. PATENT DOCUMENTS

D721,342 S *	1/2015	Kim et al. ....	D14/138 G
D722,034 S *	2/2015	Lee et al. ....	D14/138 G
D723,494 S *	3/2015	Skafdrup et al. ....	D14/138 G
D729,191 S *	5/2015	Chung et al. ....	D14/138 G
D729,192 S *	5/2015	Chang et al. ....	D14/138 G
D730,310 S *	5/2015	Hundt et al. ....	D14/138 G

OTHER PUBLICATIONS

Xiaomi Redmi Note 4G, announced Aug. 2014, [online], [site visited Jun. 2, 2015]. Available from Internet, <URL: [http://www.gsmarena.com/xiaomi\\_redmi\\_note\\_4g-6561.php](http://www.gsmarena.com/xiaomi_redmi_note_4g-6561.php)>.\*

ZTE Grand S3, announced Mar. 2015, [online], [site visited Jun. 2, 2015]. Available from Internet, <URL: [http://www.gsmarena.com/zte\\_grand\\_s3-7078.php](http://www.gsmarena.com/zte_grand_s3-7078.php)>.\*

Motorola Milestone XT883, announced Jun. 2011, [online], [site visited Jun. 2, 2015]. Available from Internet, <URL: [http://www.gsmarena.com/motorola\\_milestone\\_xt883-4025.php](http://www.gsmarena.com/motorola_milestone_xt883-4025.php)>.\*

LG Optimus 3D P920, announced Jan. 2011, [online], [site visited Jun. 26, 2015]. Available from Internet, <URL: [http://www.gsmarena.com/lg\\_optimus\\_3d\\_p920-3759.php](http://www.gsmarena.com/lg_optimus_3d_p920-3759.php)>.\*

Nokia website showing "Lumia 1020" phone Retrieved on Mar. 13, 2014 from URL: <http://www.nokia.com/global/products/products/phone/lumia1020/>.

LG website showing "LG 82" phone Retrieved on Mar. 13, 2014 from URL: <http://www.gsmarena.com/lg>.

\* cited by examiner

FIG. 1

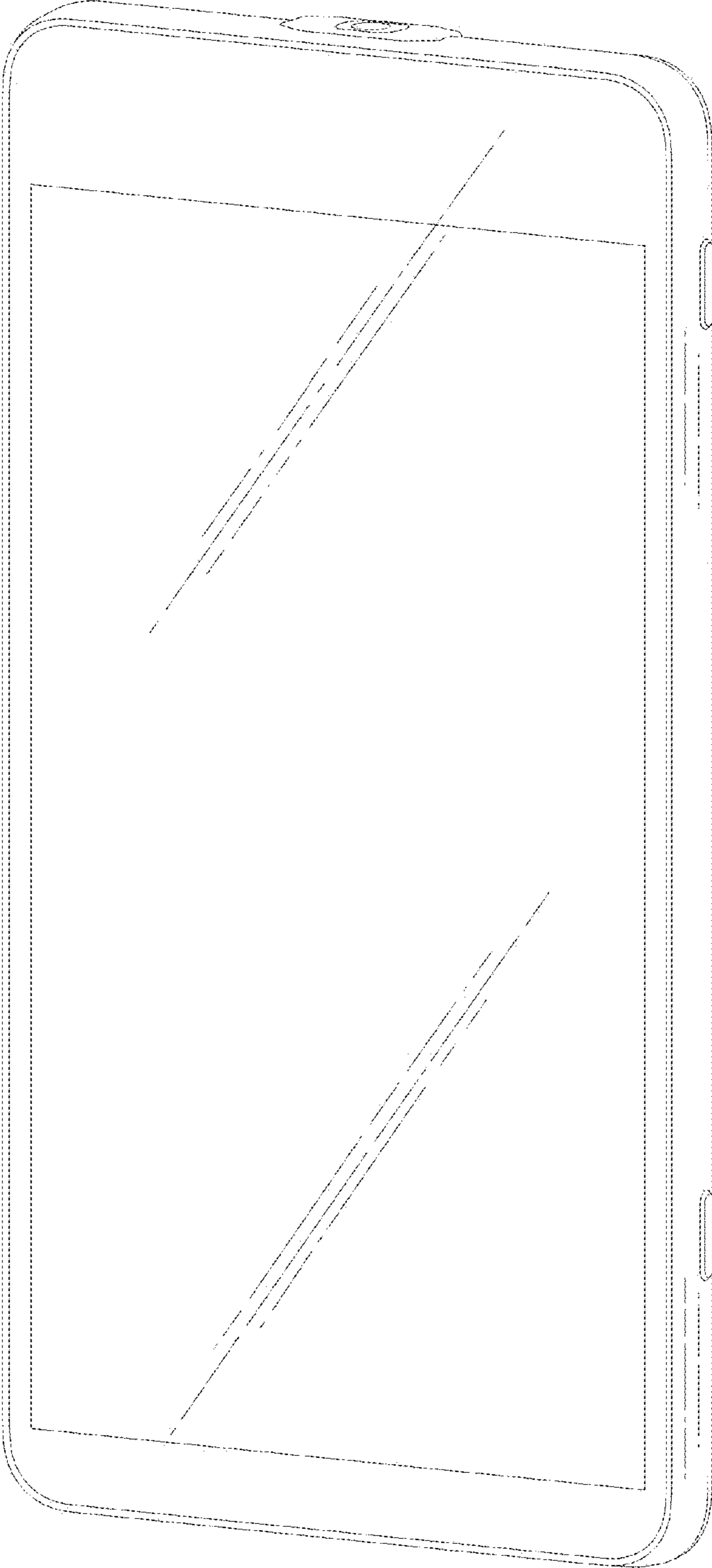

FIG.2

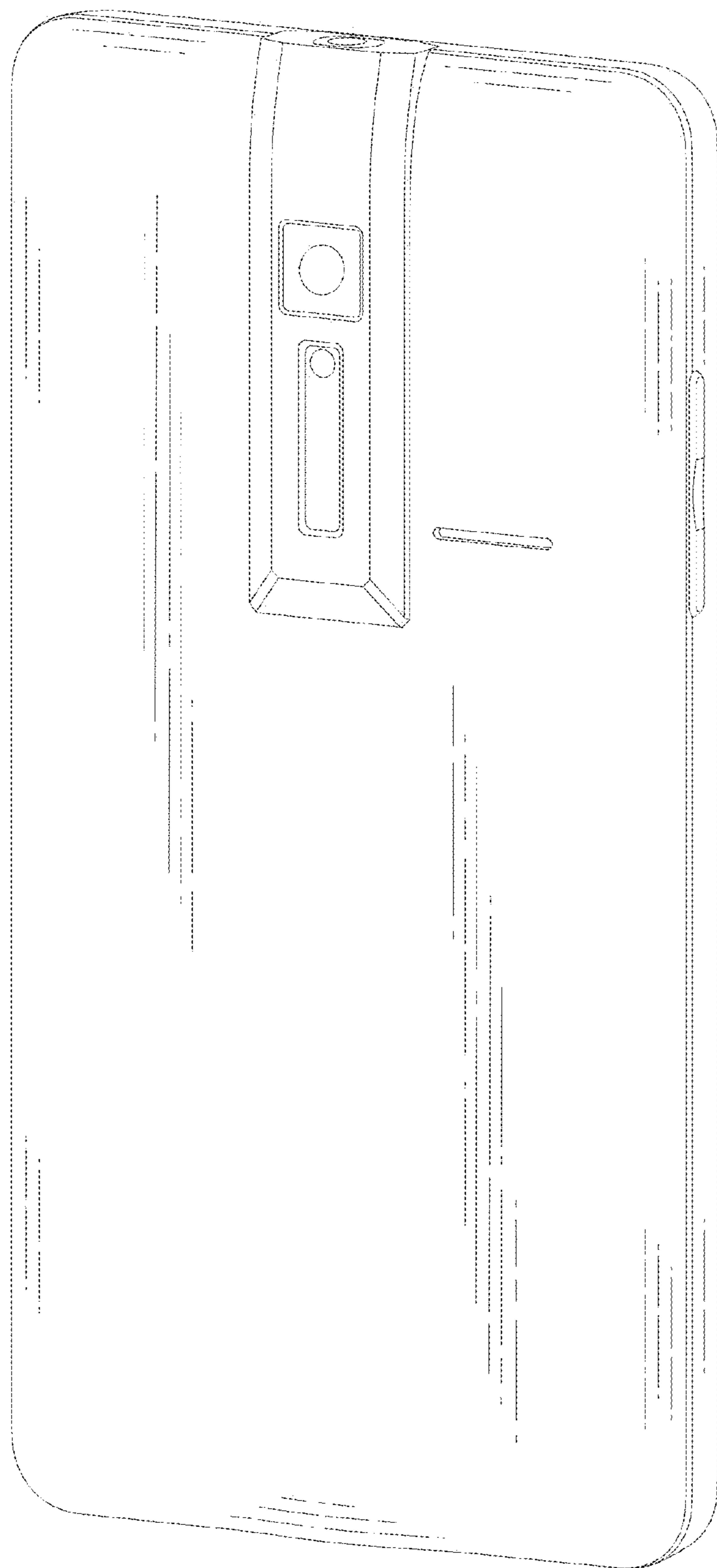

FIG.3

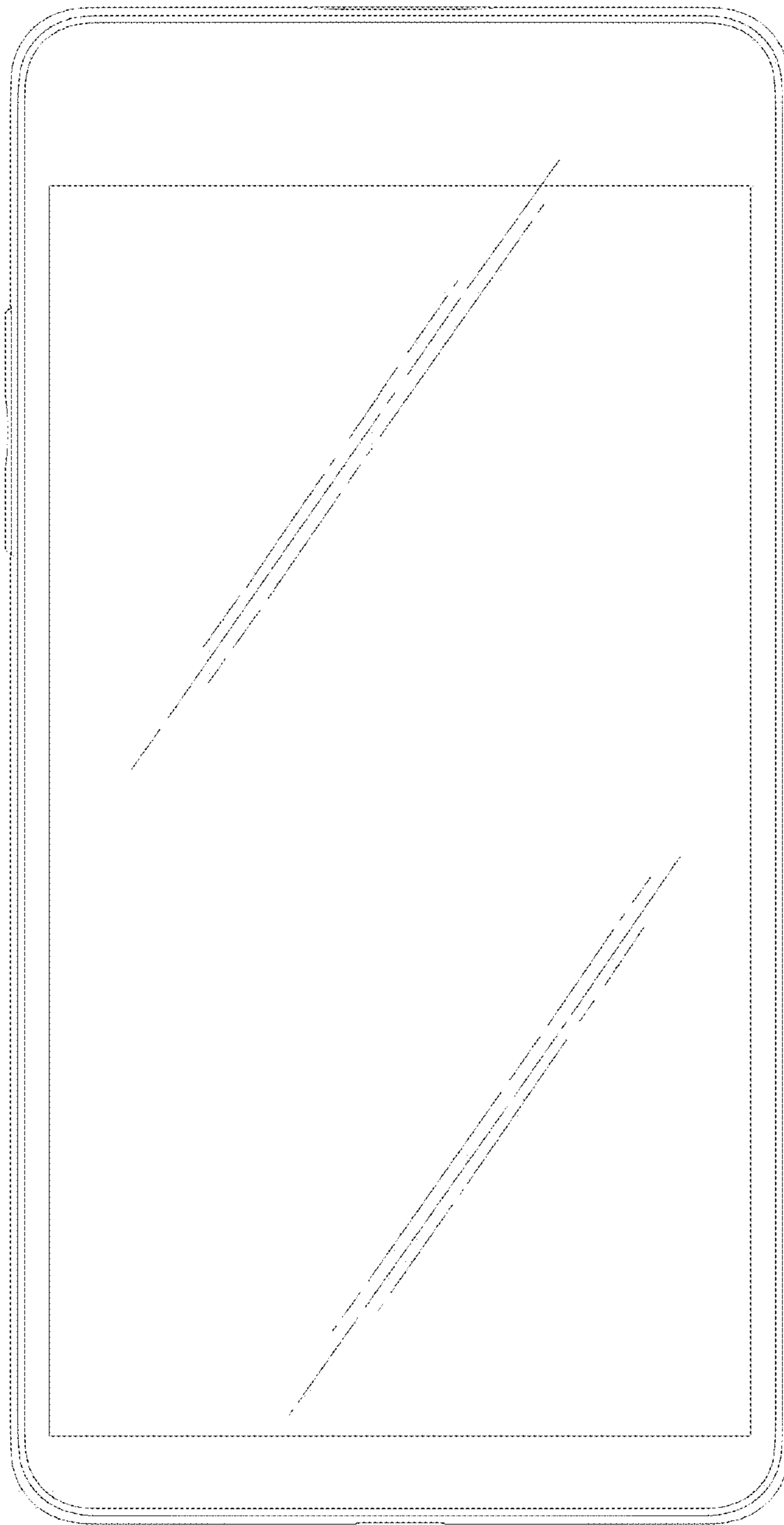

FIG.4

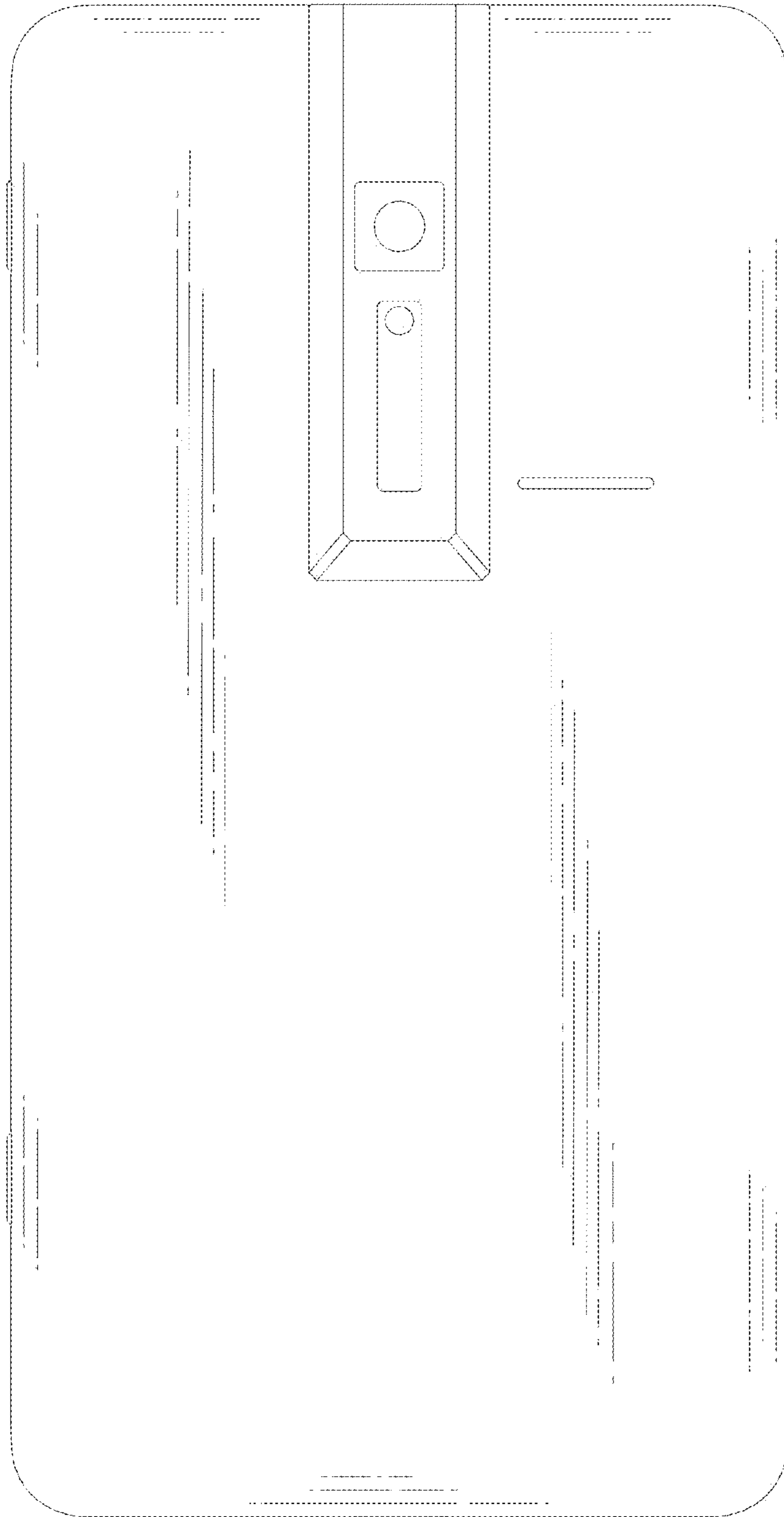

FIG.5

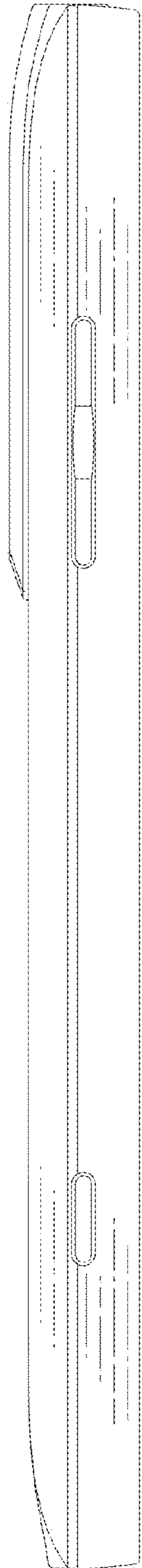

FIG.6

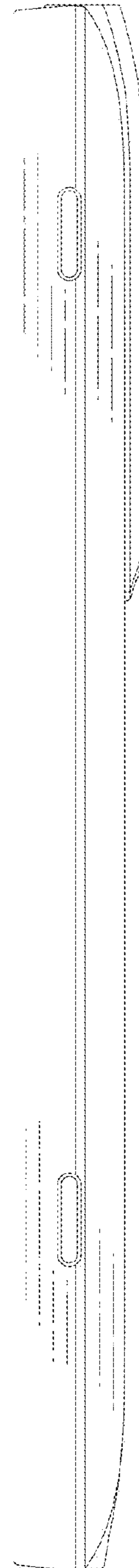

FIG.7

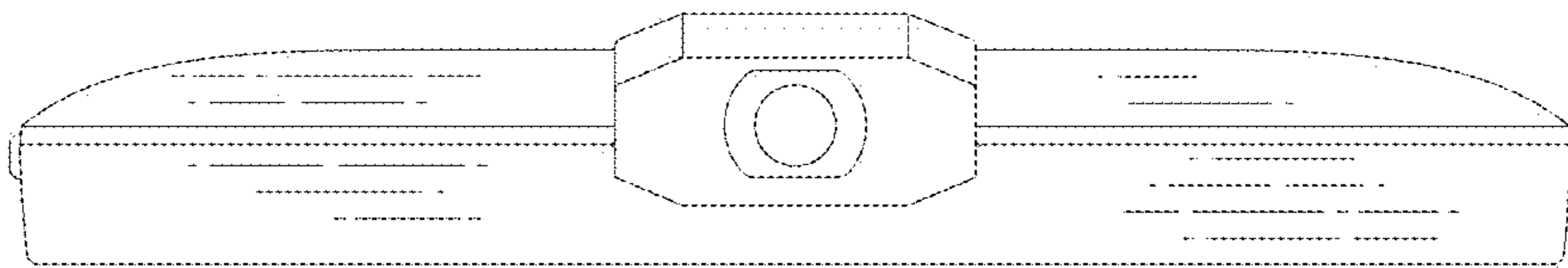

FIG.8

