



US00D742835S

(12) **United States Design Patent**  
**Gieski et al.**

(10) **Patent No.:** **US D742,835 S**

(45) **Date of Patent:** **\*\* Nov. 10, 2015**

(54) **ELECTRICAL CONNECTOR HOUSING**

(71) Applicants: **Christopher S. Gieski**, Dillsburg, PA (US); **William E. Tanis**, Mechanicsburg, PA (US); **Gregory A. Hull**, York, PA (US)

(72) Inventors: **Christopher S. Gieski**, Dillsburg, PA (US); **William E. Tanis**, Mechanicsburg, PA (US); **Gregory A. Hull**, York, PA (US)

(73) Assignee: **FCI AMERICAS TECHNOLOGY LLC**, Carson City, NV (US)

(\*\*) Term: **14 Years**

(21) Appl. No.: **29/473,975**

(22) Filed: **Nov. 27, 2013**

(51) **LOC (10) Cl.** ..... **13-03**

(52) **U.S. Cl.**  
USPC ..... **D13/154**

(58) **Field of Classification Search**  
USPC ..... D13/146, 147, 154, 184, 199  
See application file for complete search history.

(56) **References Cited**

**U.S. PATENT DOCUMENTS**

D517,992 S *	3/2006	Riku	.....	D13/147
D520,454 S *	5/2006	Riku	.....	D13/147
D616,827 S	6/2010	Ngo et al.		
D626,074 S	10/2010	Ngo et al.		
D629,761 S	12/2010	Ngo et al.		
D636,737 S *	4/2011	Ngo et al.	.....	D13/154
D713,356 S *	9/2014	Buck et al.	.....	D13/154
2013/0273781 A1	10/2013	Buck et al.		

**OTHER PUBLICATIONS**

U.S. Appl. No. 29/473,981, filed Nov. 27, 2013, Gieski et al.

\* cited by examiner

*Primary Examiner* — Daniel Bui

(74) *Attorney, Agent, or Firm* — Baker & Hostetler LLP

(57) **CLAIM**

The ornamental design for an electrical connector housing, as shown and described.

**DESCRIPTION**

FIG. 1 is a top, left, front perspective view of an electrical connector housing showing our new design;  
 FIG. 2 is a bottom, right, rear perspective view thereof;  
 FIG. 3 is a bottom, right, front perspective view thereof;  
 FIG. 4 is an enlarged view of area 4 of FIG. 3;  
 FIG. 5 is an enlarged view of area 5 of FIG. 3;  
 FIG. 6 is a top, left, front perspective view thereof;  
 FIG. 7 is an enlarged view of area 7 of FIG. 6;  
 FIG. 8 is a top, left, rear perspective view thereof;  
 FIG. 9 is an enlarged view of area 9 of FIG. 8;  
 FIG. 10 is a bottom, right, rear perspective view thereof;  
 FIG. 11 is an enlarged view of area 11 of FIG. 10;  
 FIG. 12 is a front elevation view thereof;  
 FIG. 13 is a rear elevation view thereof;  
 FIG. 14 top plan view thereof;  
 FIG. 15 is a bottom plan view thereof;  
 FIG. 16 is a right side elevation view thereof; and,  
 FIG. 17 is a left side elevation view thereof.

The broken line portion of the figure drawings is included to show unclaimed subject matter only for the purpose of illustrating environment and forms no part of the claimed design.

**1 Claim, 12 Drawing Sheets**

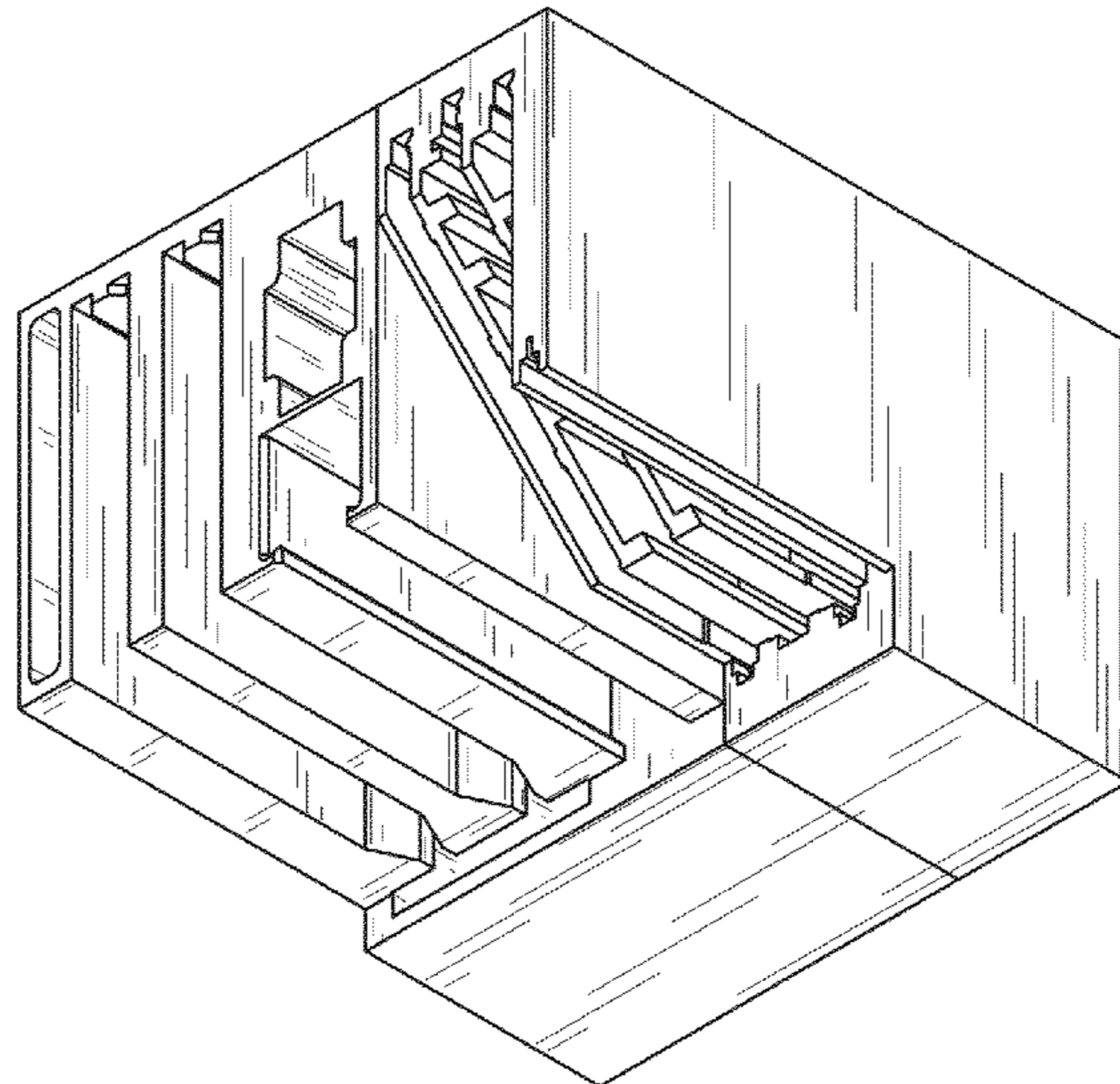
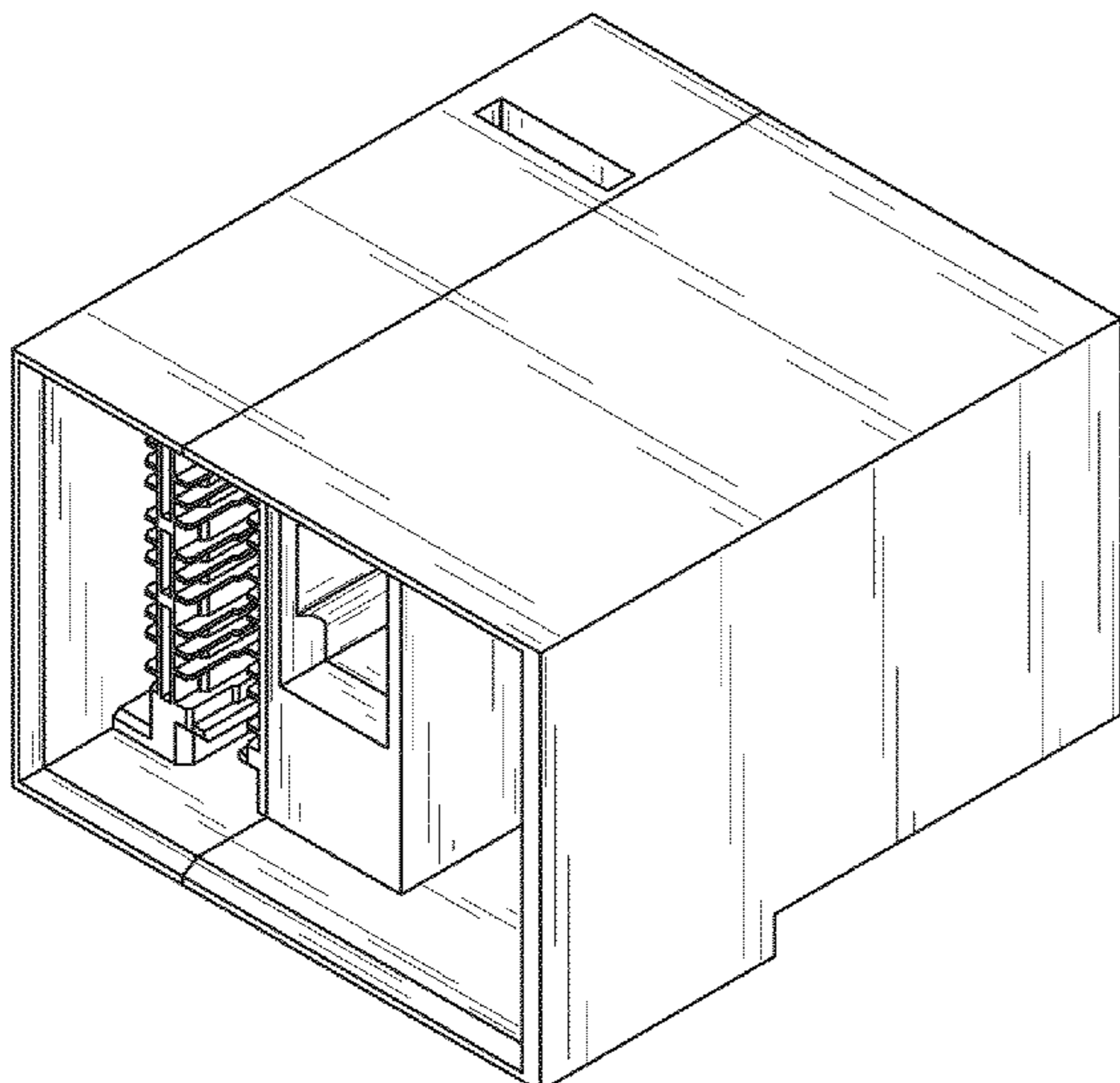

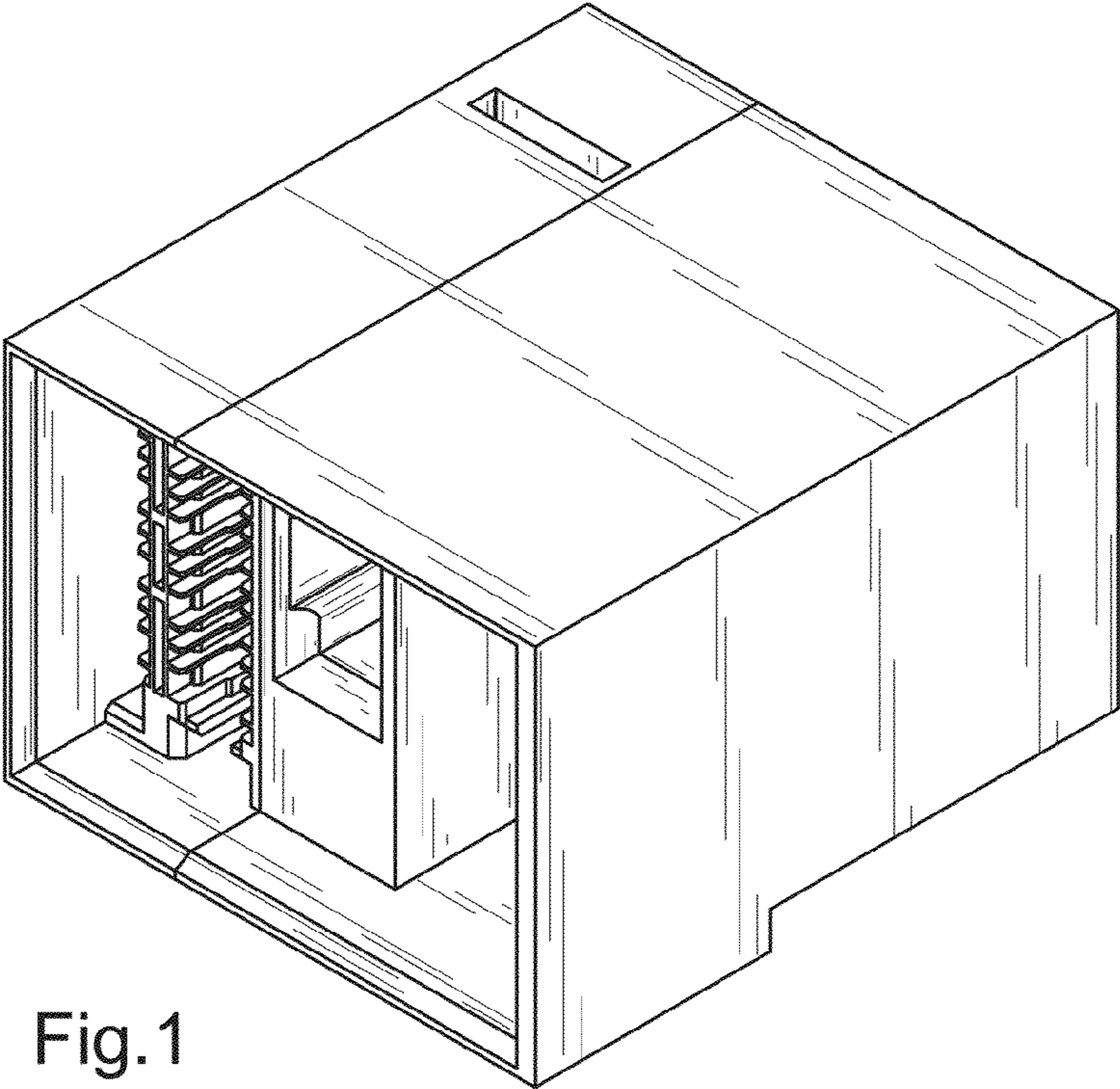

Fig.1

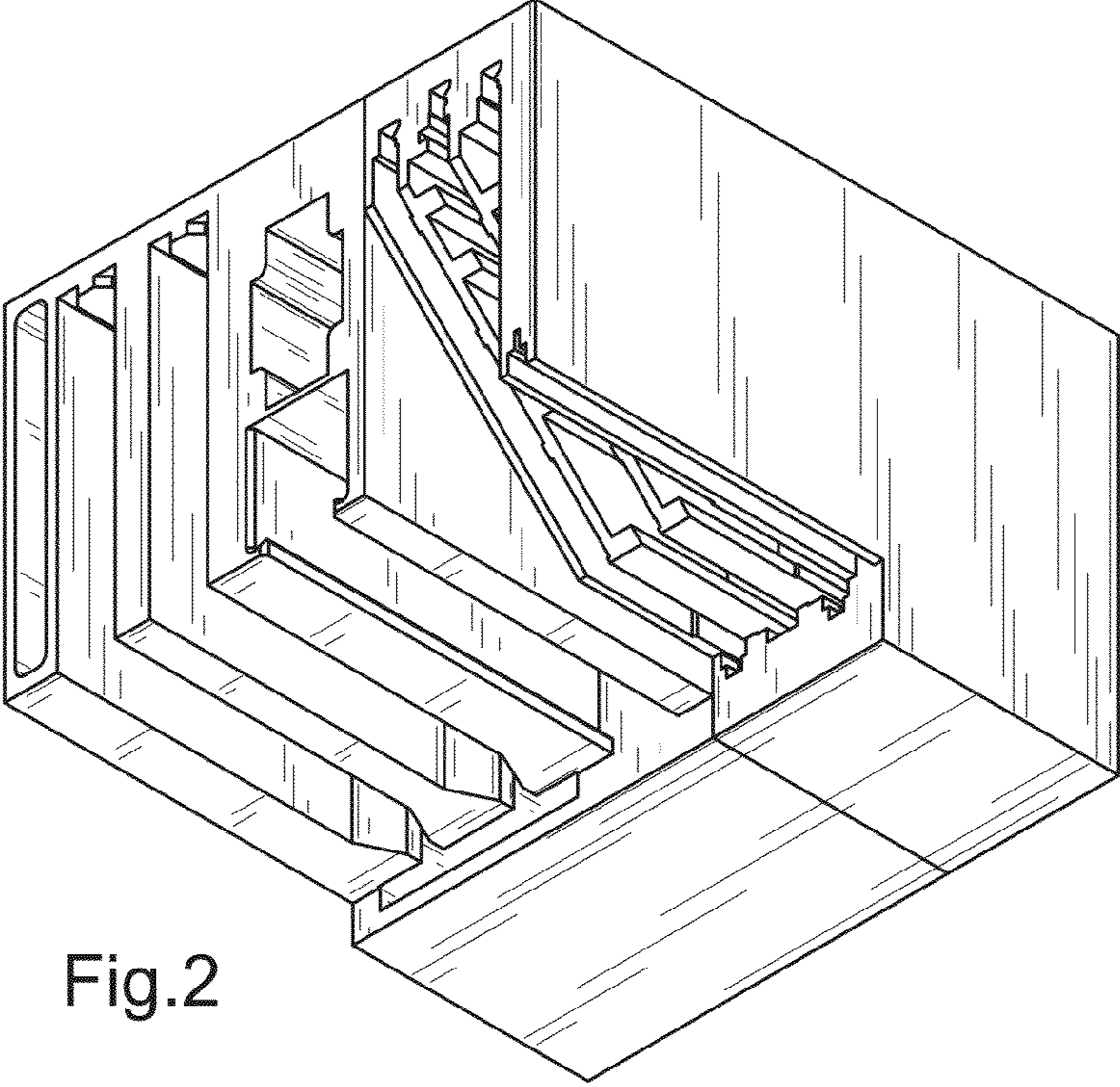

Fig.2

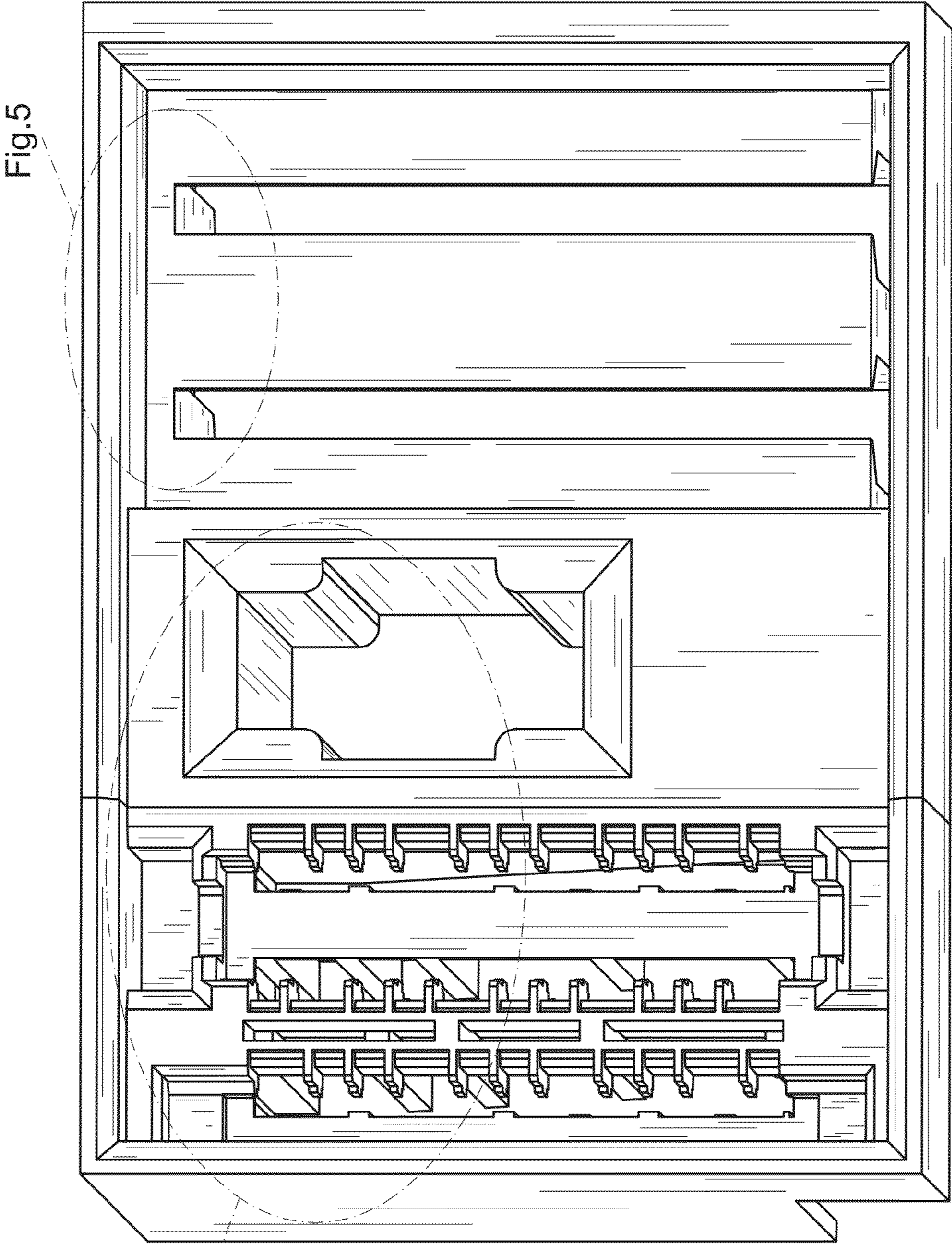

Fig.5

Fig.4

Fig.3

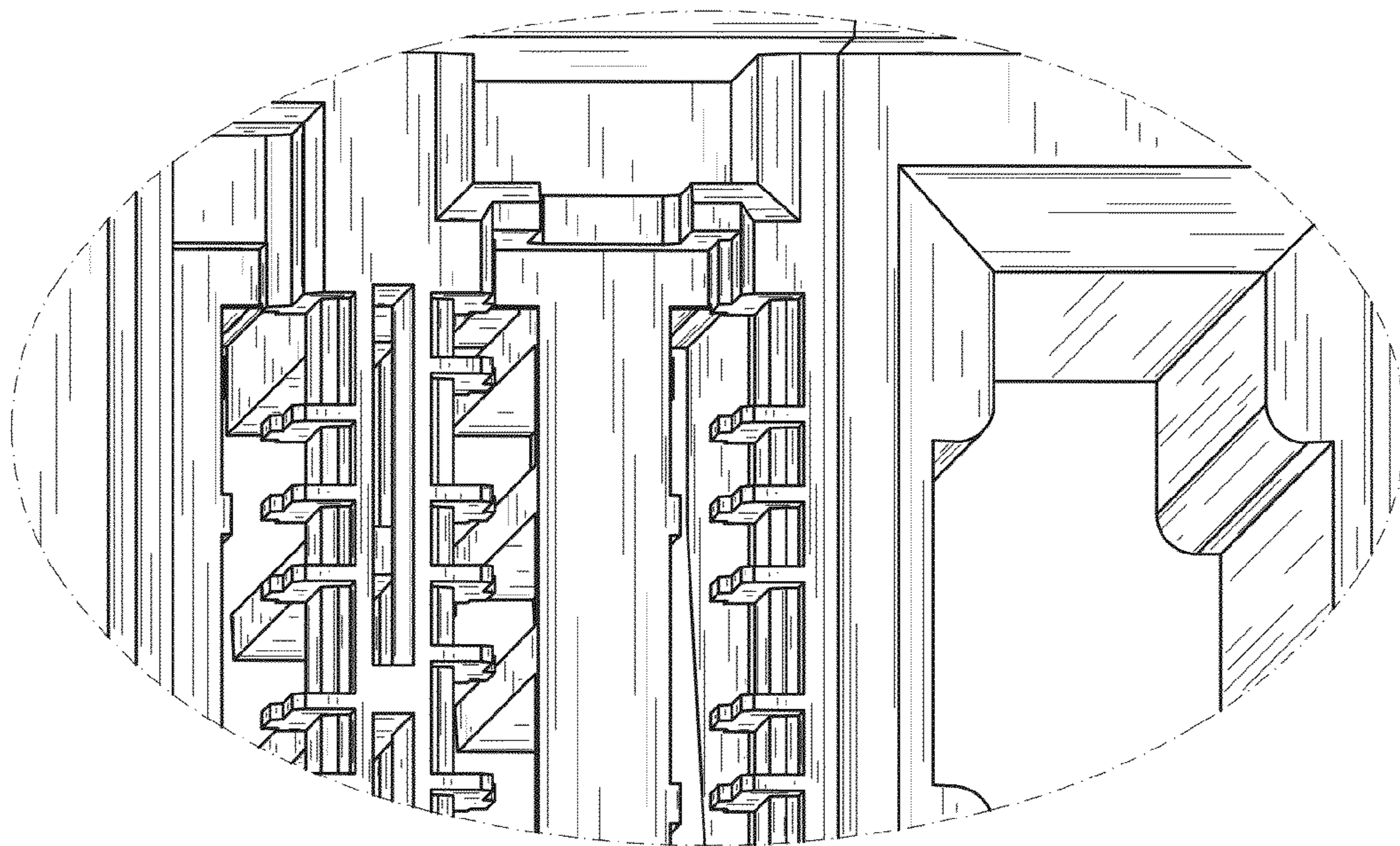

Fig.4

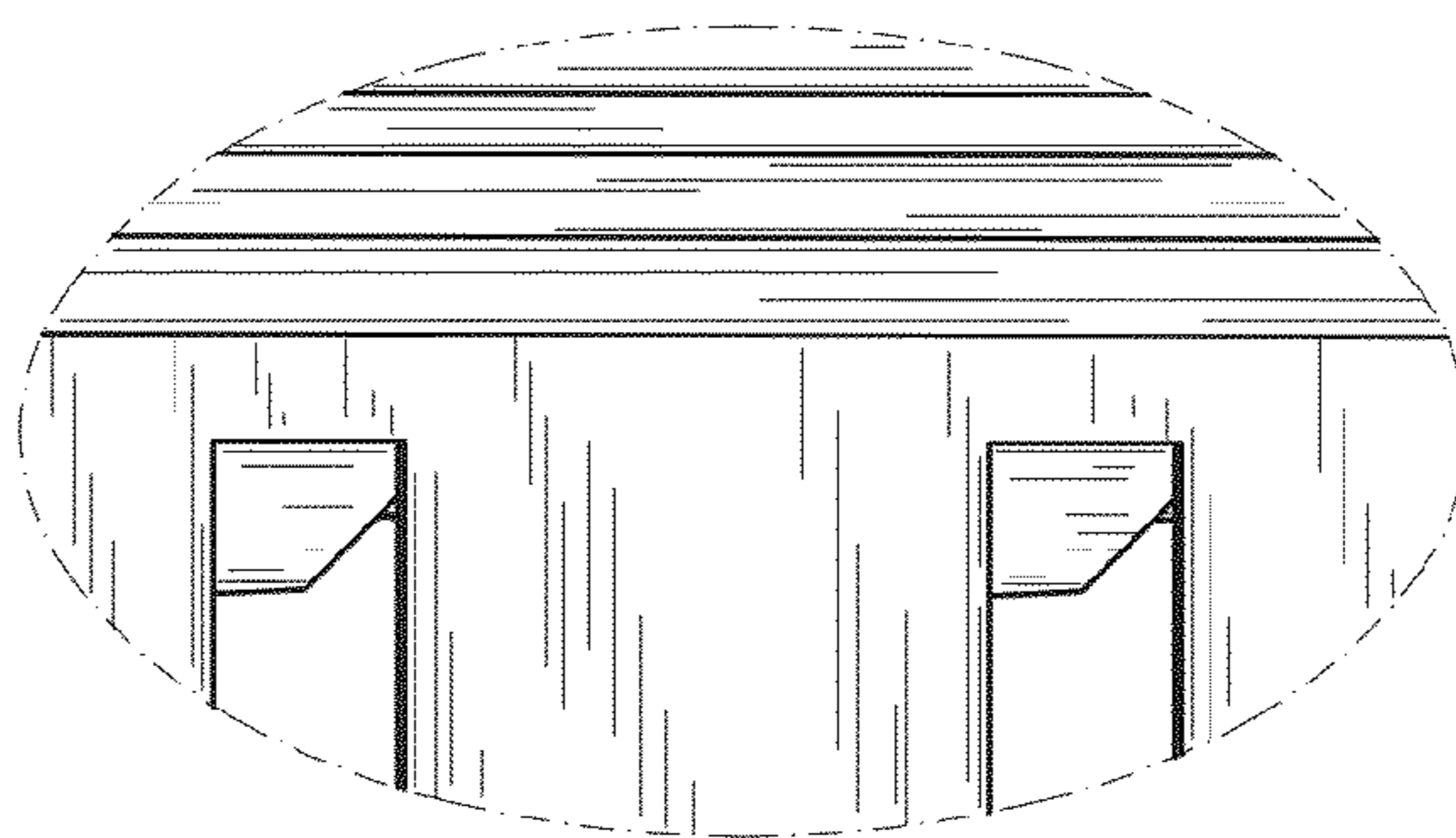

Fig.5

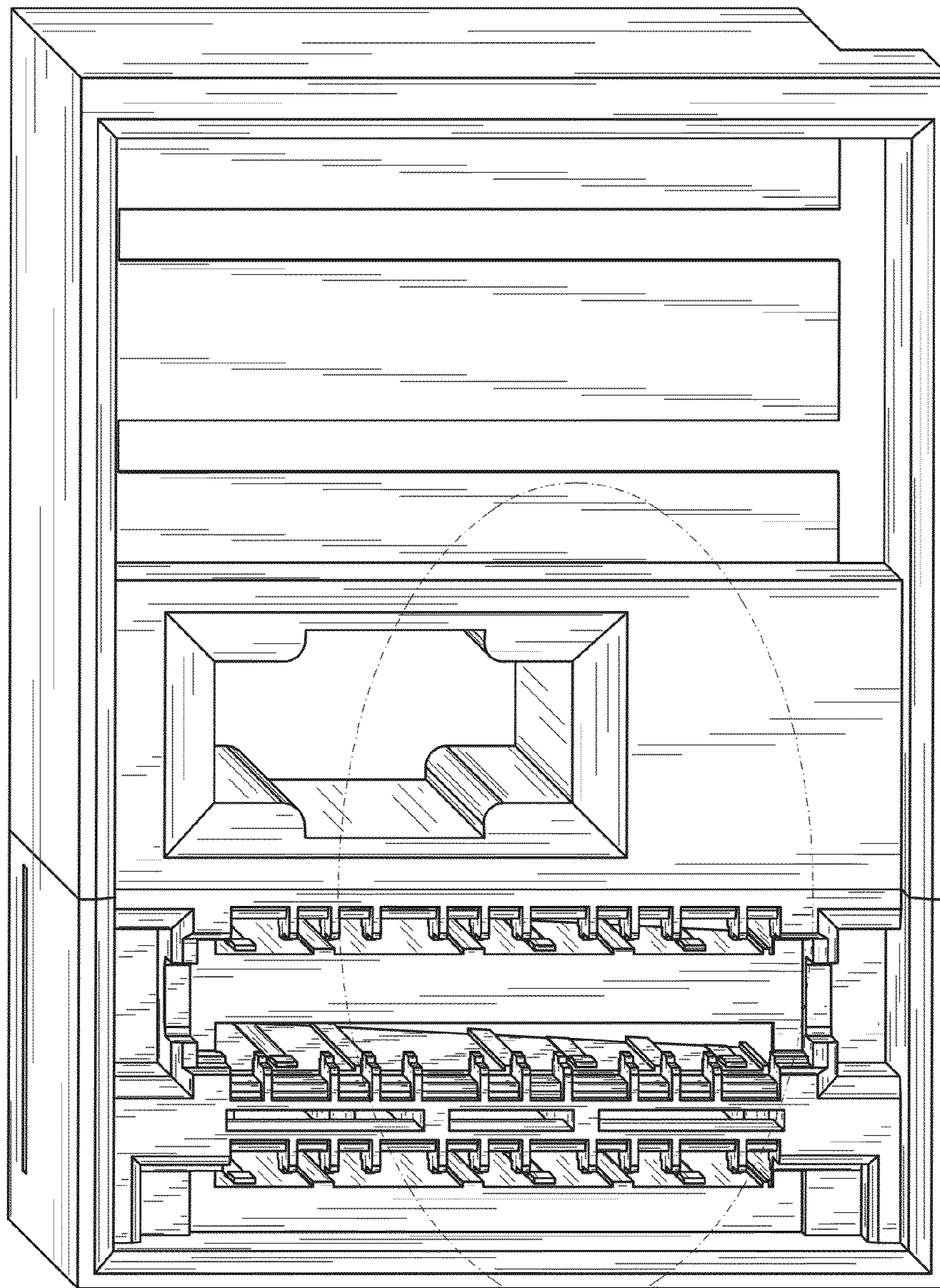

Fig.6

Fig.7

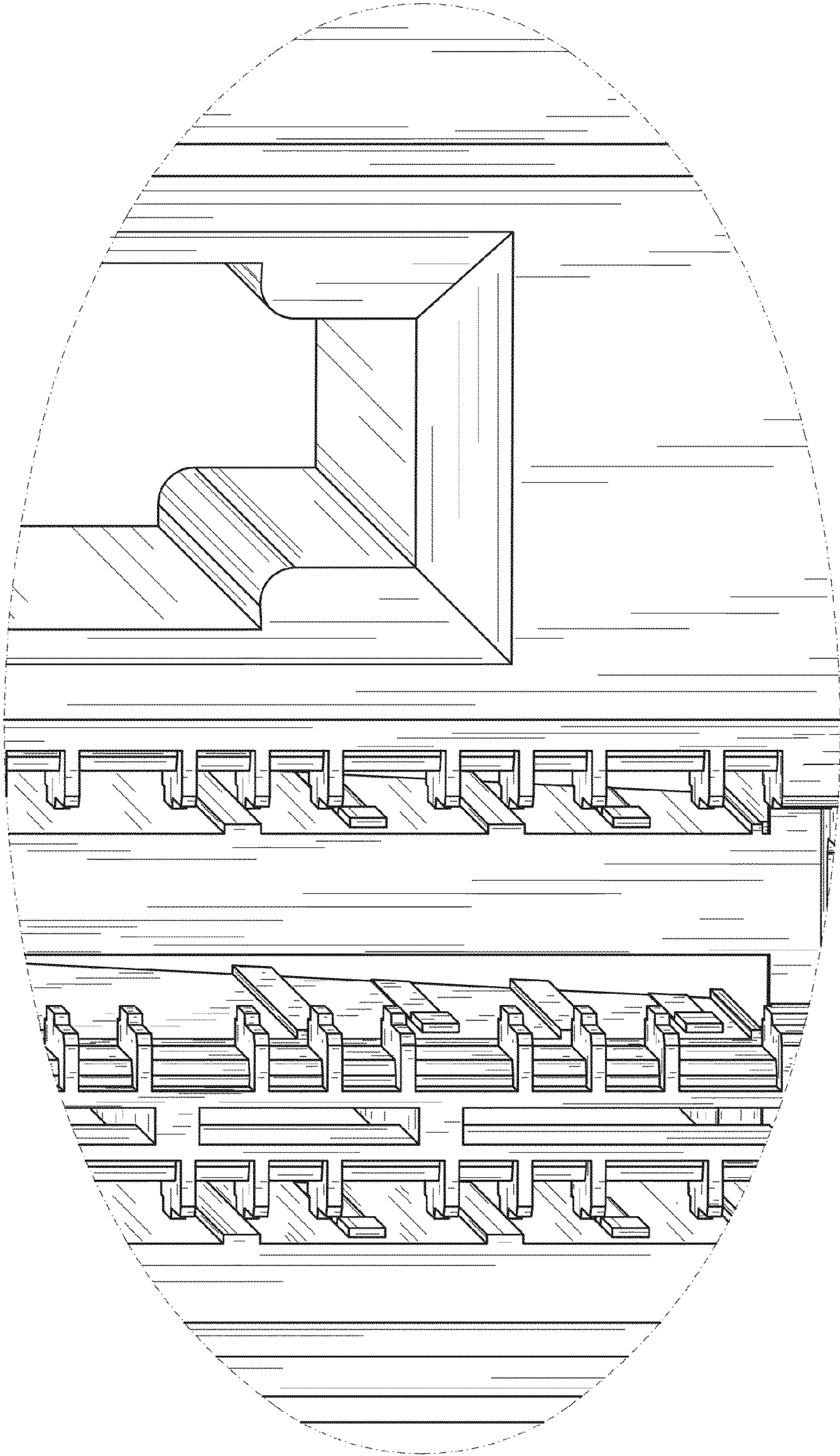

Fig.7

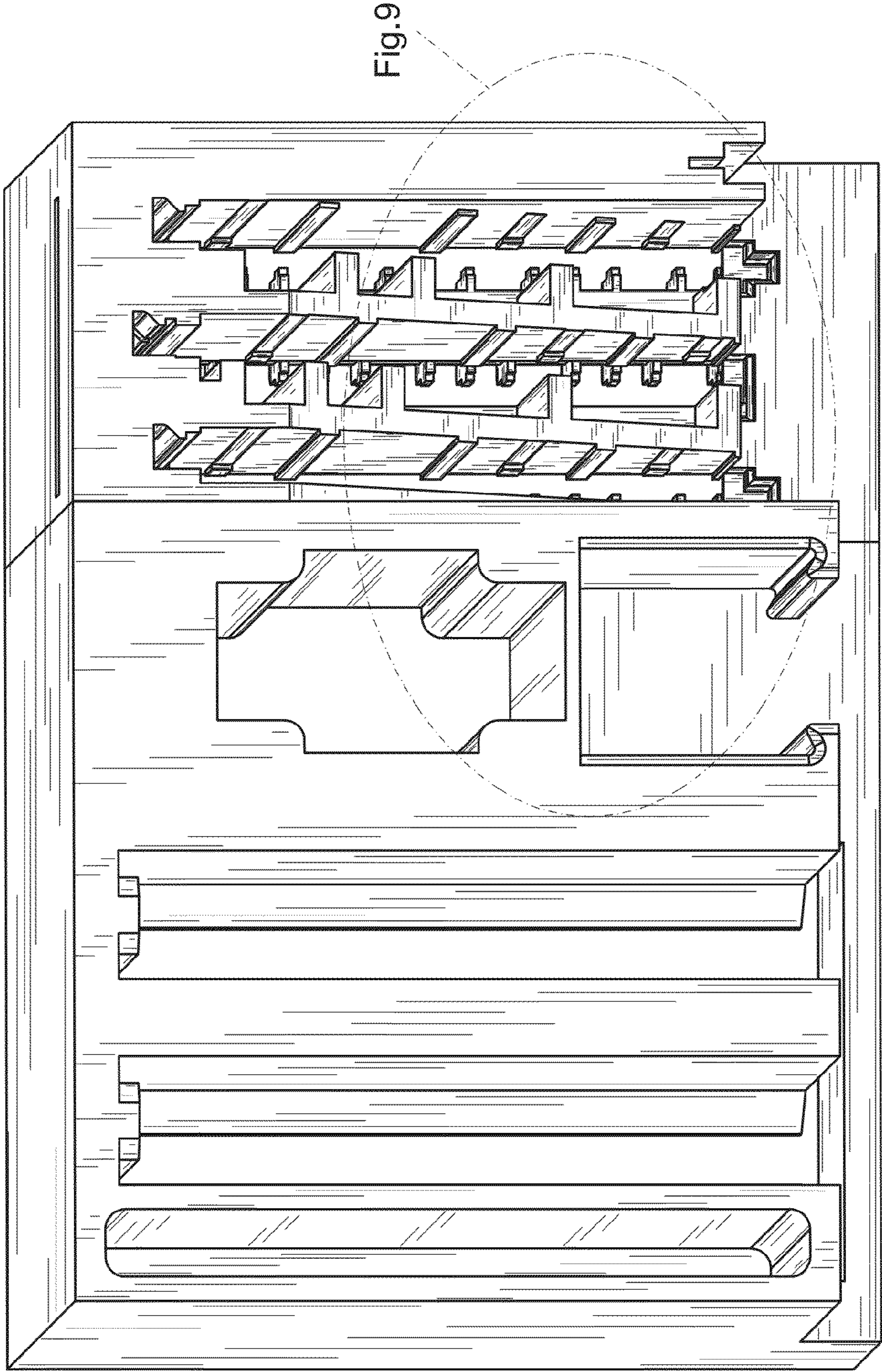

Fig. 8

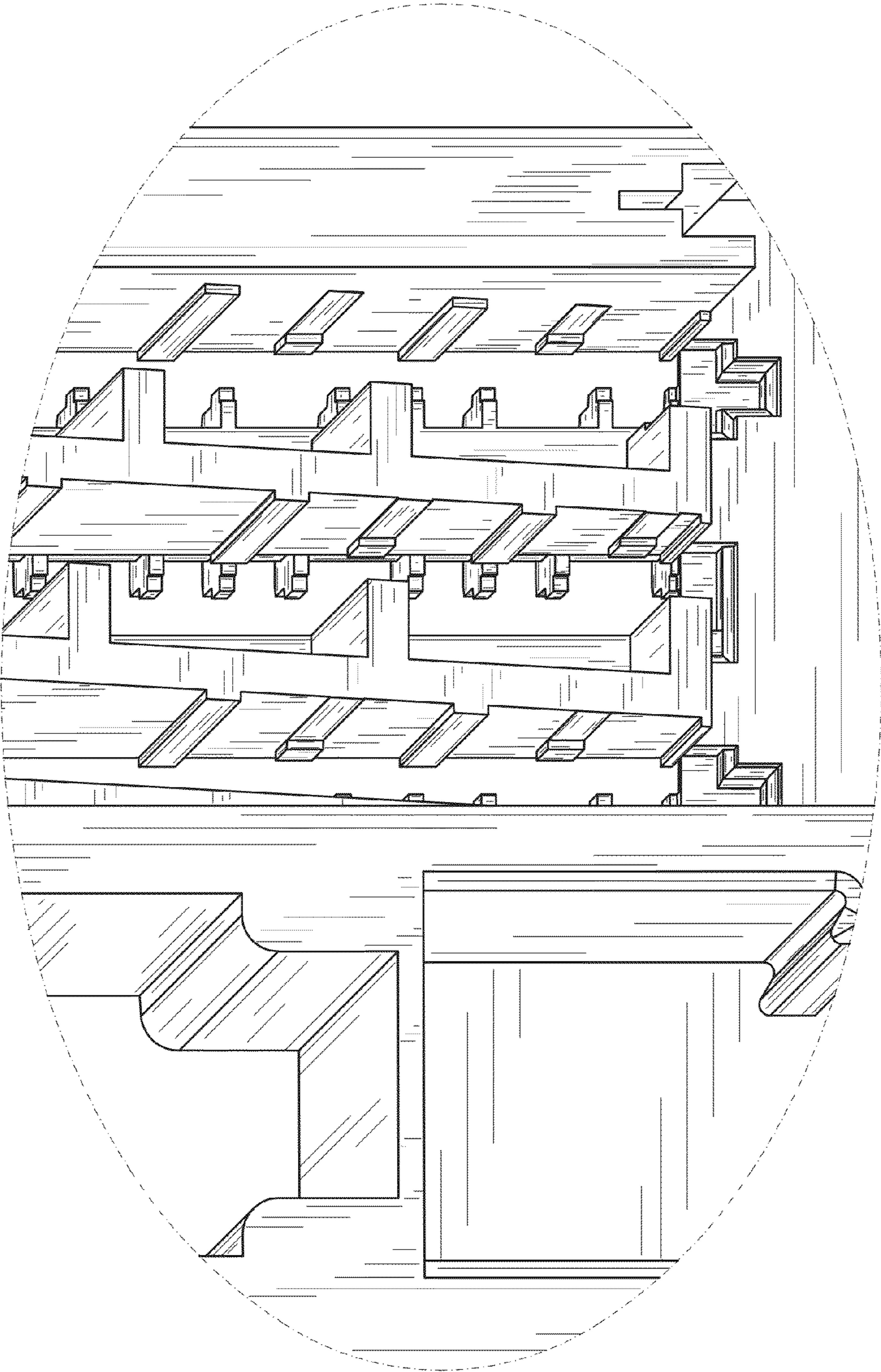

Fig.9



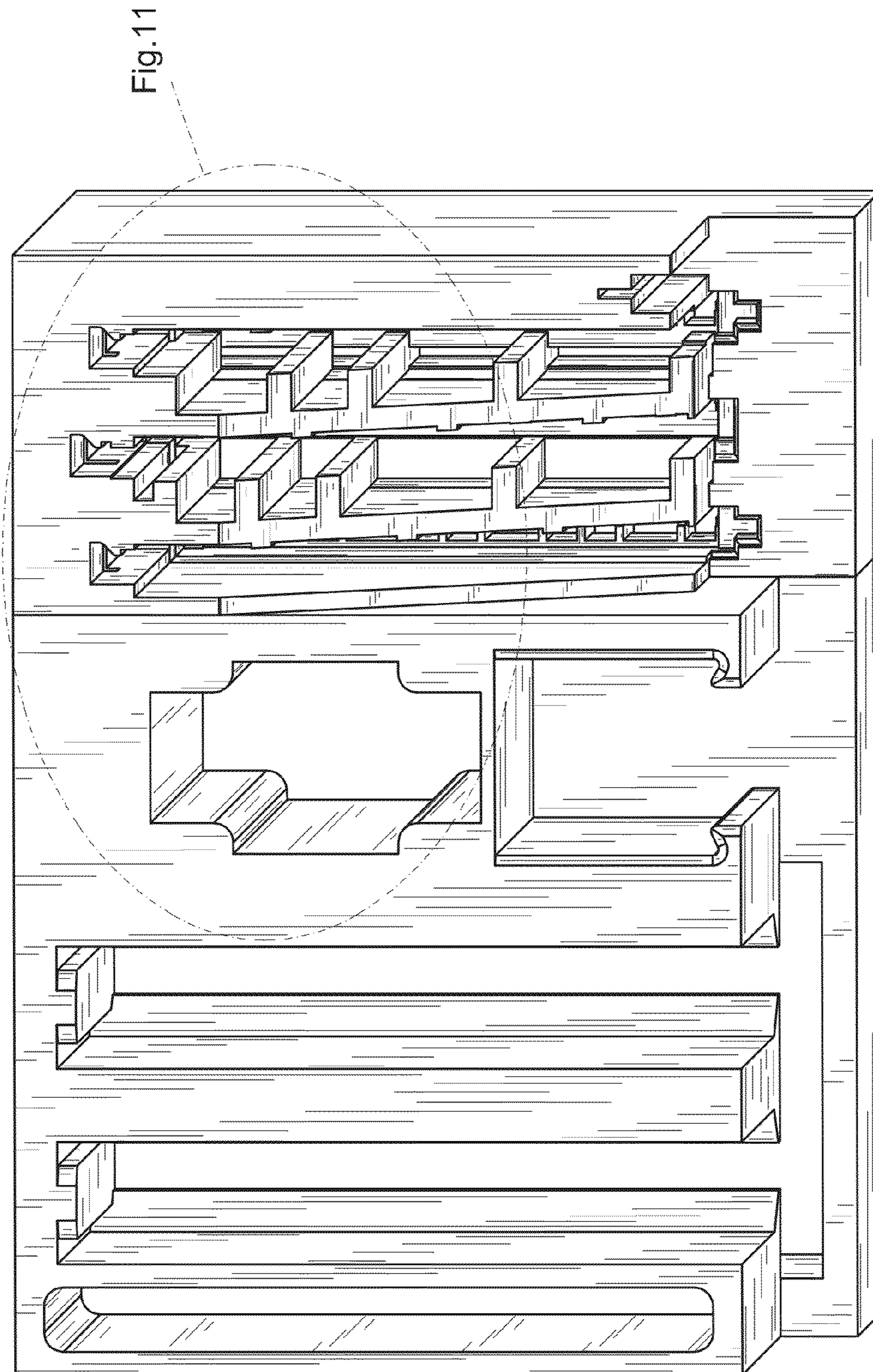

Fig. 10

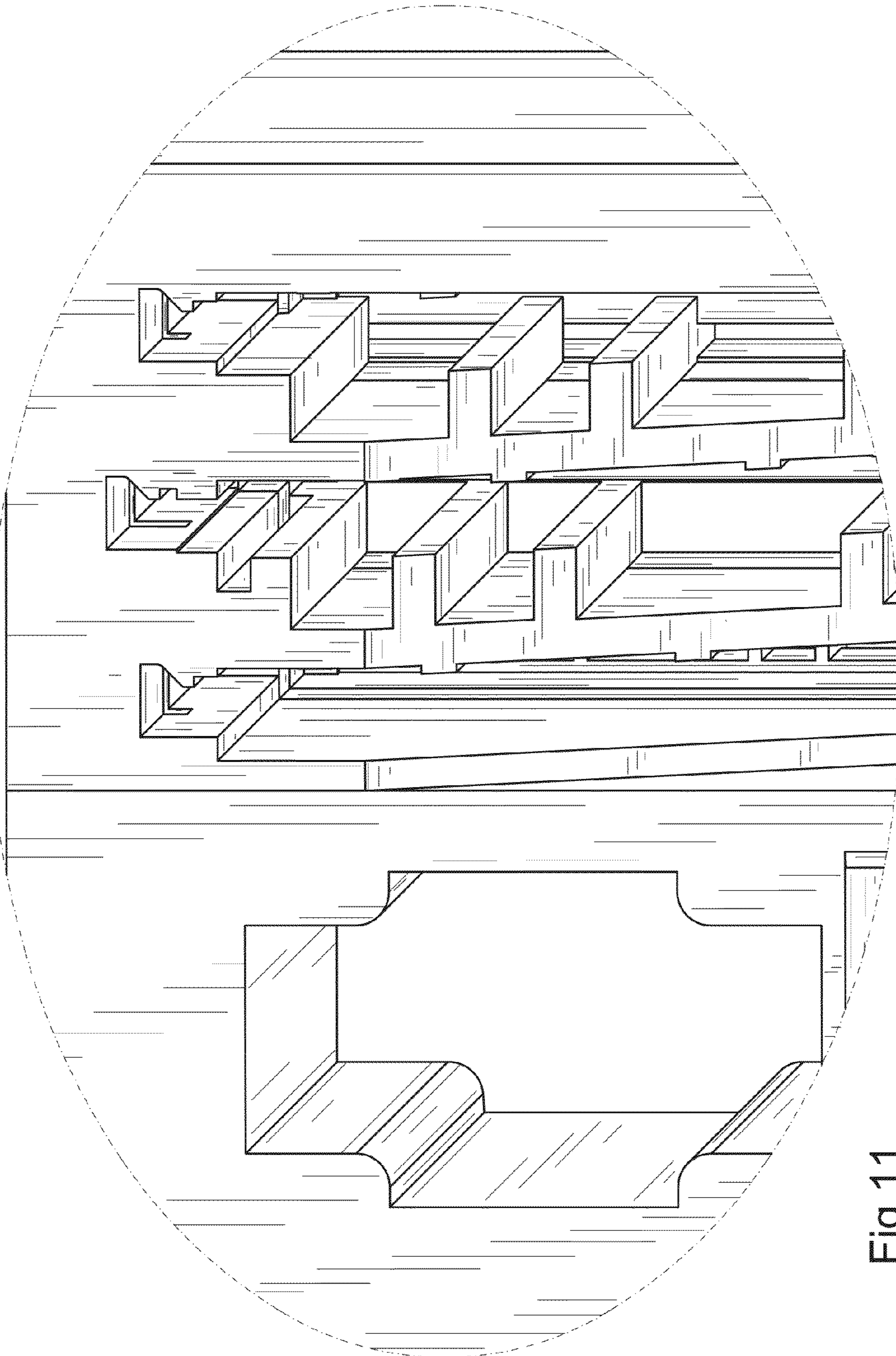

Fig.11

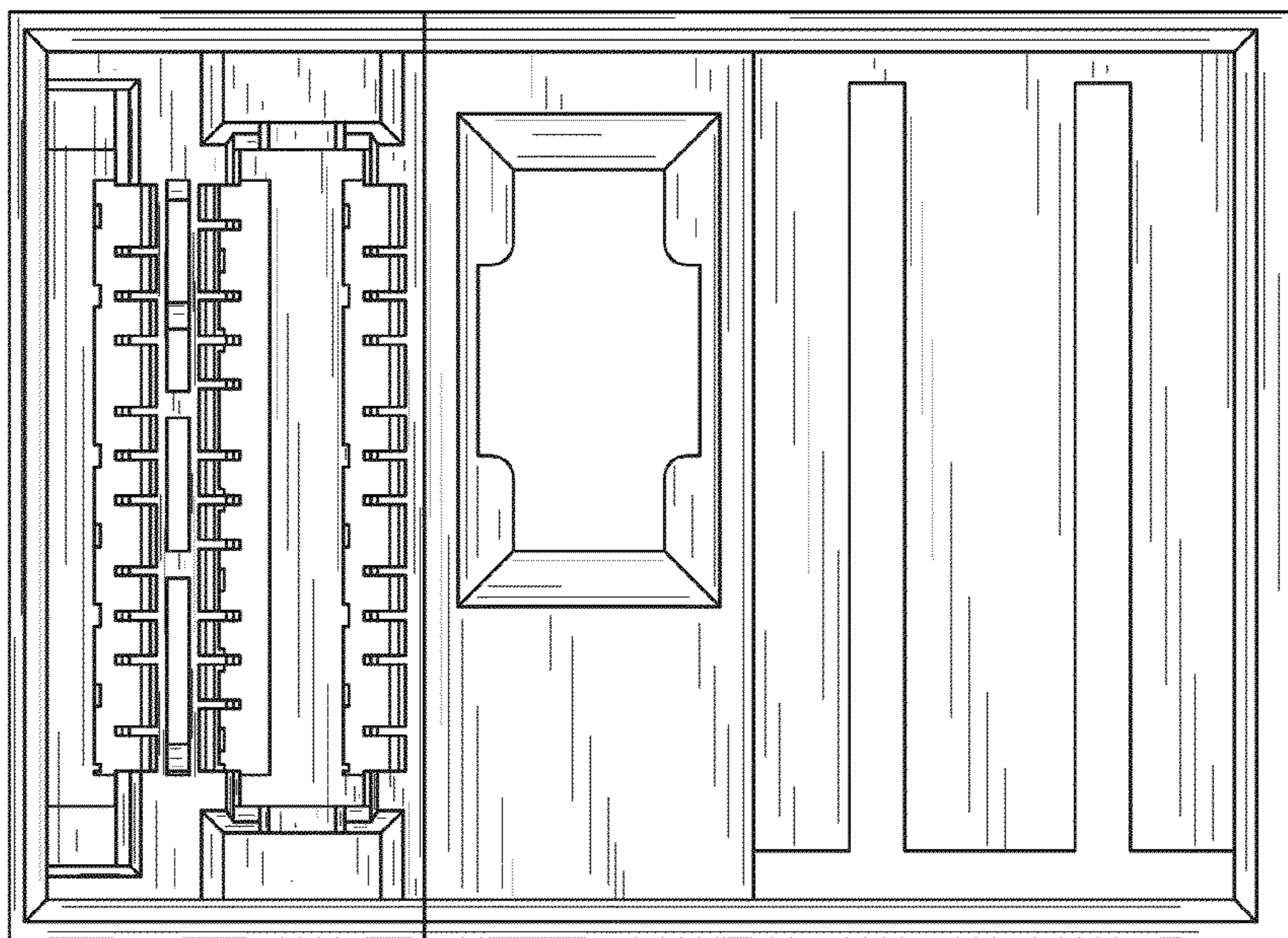

Fig. 12

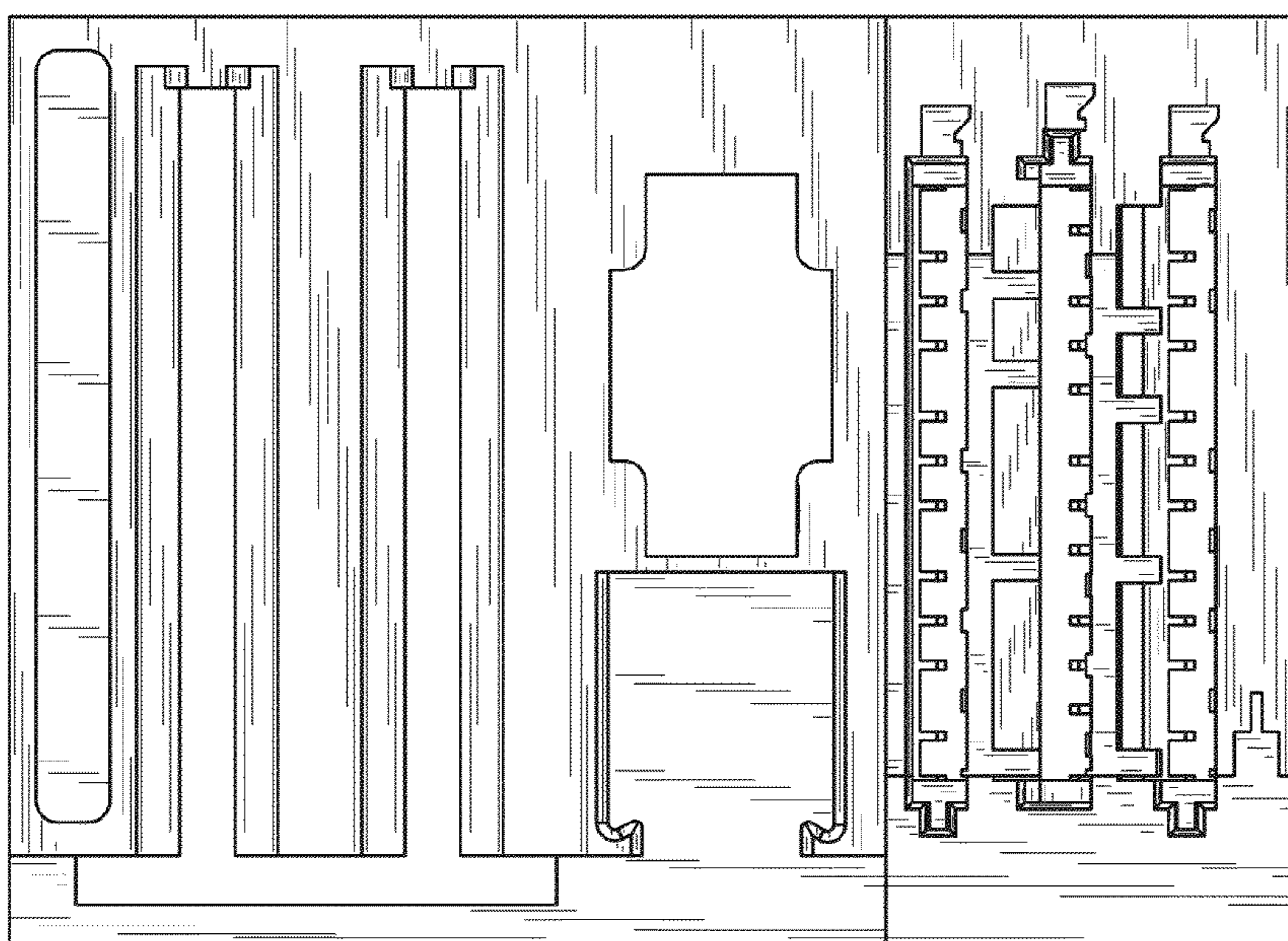

Fig. 13

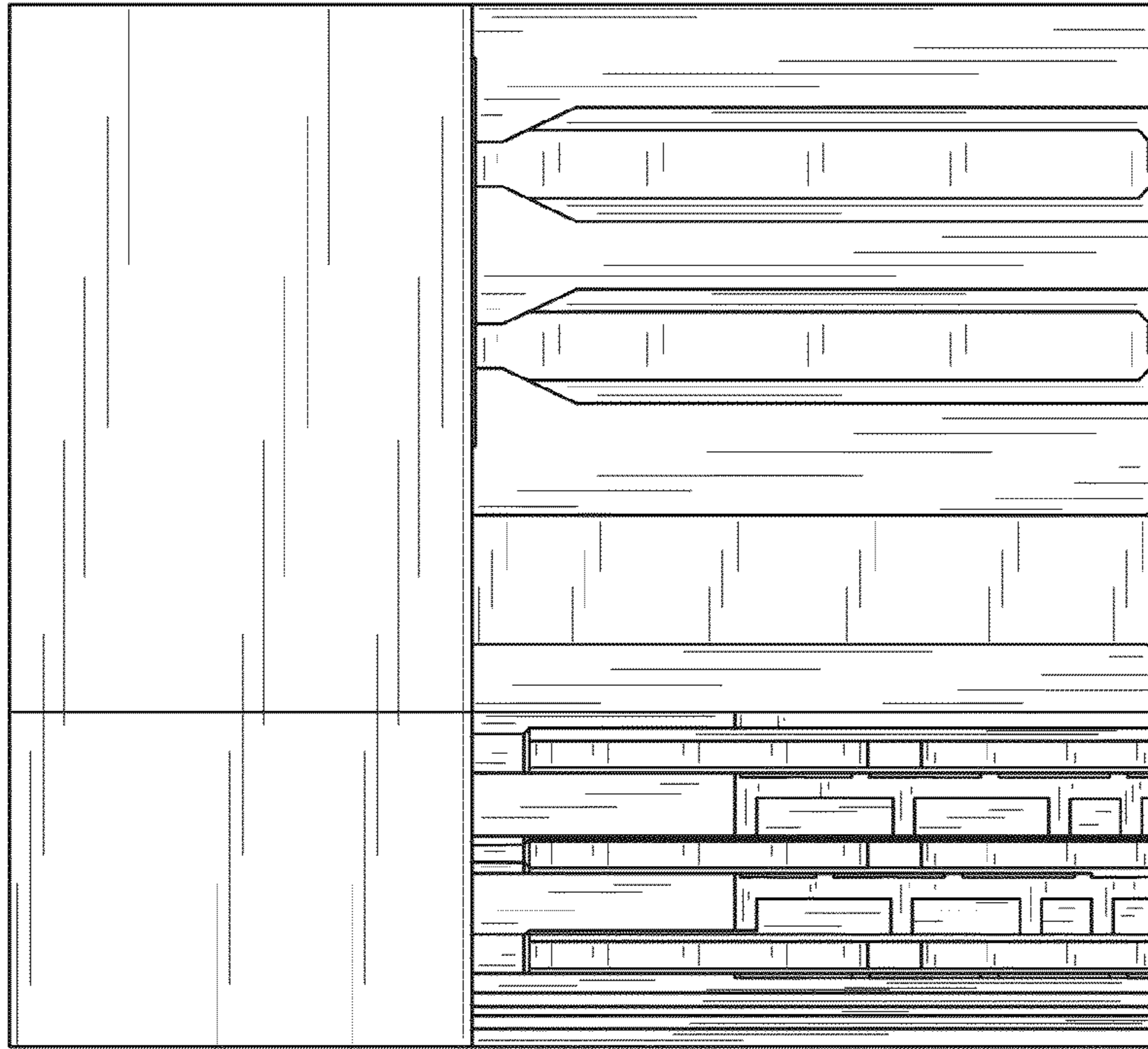

Fig. 14

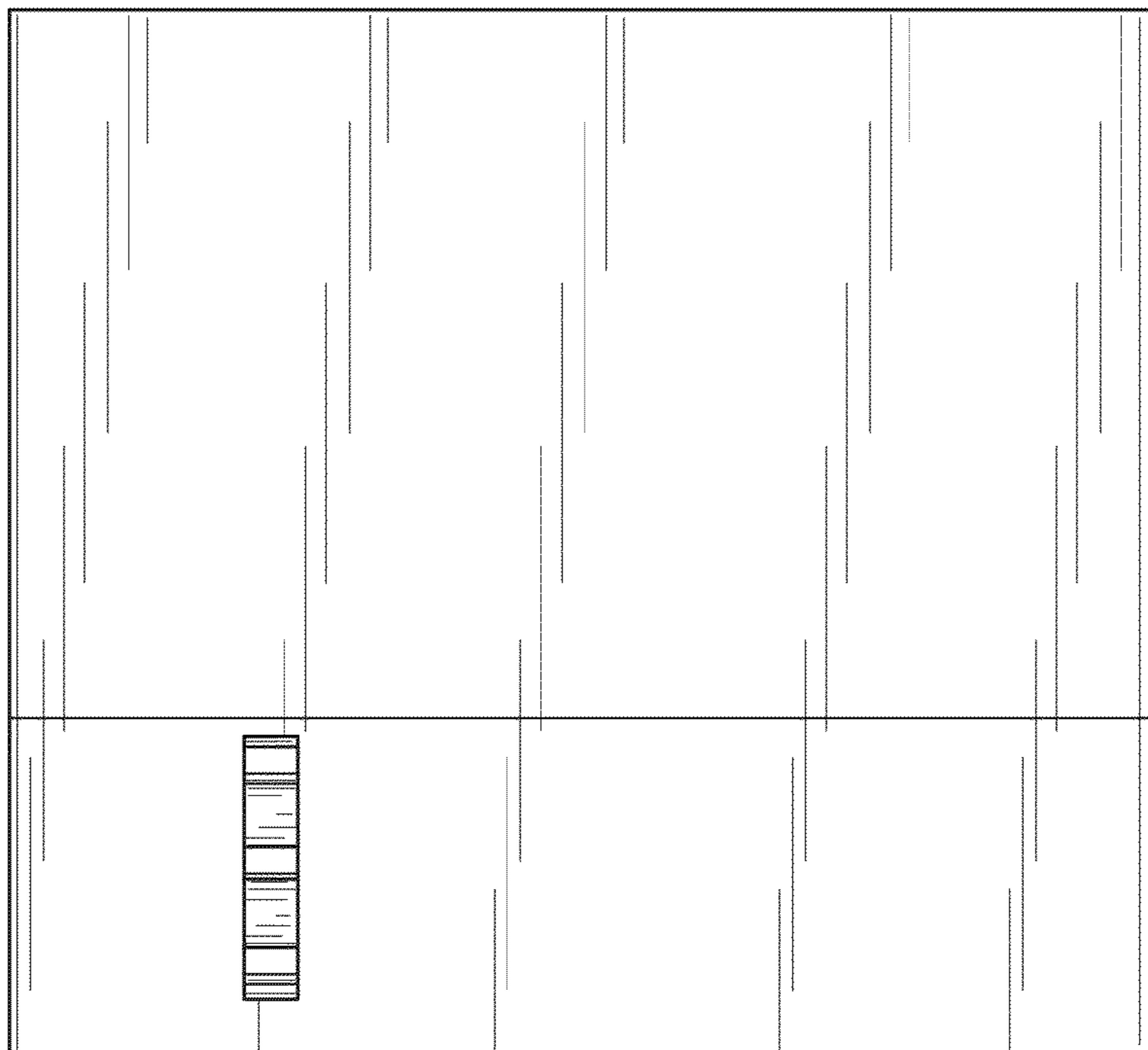

Fig. 15



Fig.16



Fig.17

UNITED STATES PATENT AND TRADEMARK OFFICE  
**CERTIFICATE OF CORRECTION**

PATENT NO. : D742,835 S  
APPLICATION NO. : 29/473975  
DATED : November 10, 2015  
INVENTOR(S) : Christopher S. Gieski et al.

Page 1 of 1

It is certified that error appears in the above-identified patent and that said Letters Patent is hereby corrected as shown below:

On The Title Page, Item (57) Description, insert after the description of the Figures:

--In a preferred embodiment, the nature of this product is an electrical connector housing for supporting electrical contacts.--

Signed and Sealed this  
Eighteenth Day of October, 2016



Michelle K. Lee  
*Director of the United States Patent and Trademark Office*