



US00D742758S

(12) **United States Design Patent**
Seehoff et al.

(10) **Patent No.:** **US D742,758 S**

(45) **Date of Patent:** **** Nov. 10, 2015**

(54) **SPRAY BOTTLE**

(71) Applicant: **Evriholder Products, LLC**, Anaheim, CA (US)

(72) Inventors: **Gary S. Seehoff**, Encino, CA (US); **Huy Kha Nguyen**, Anaheim, CA (US)

(73) Assignee: **EVRIHOLDER Products, LLC**, Anaheim, CA (US)

(**) Term: **14 Years**

(21) Appl. No.: **29/448,130**

(22) Filed: **Mar. 9, 2013**

(51) **LOC (10) Cl.** **09-01**

(52) **U.S. Cl.**
USPC **D9/685**; D9/692

(58) **Field of Classification Search**

USPC D9/600–681, 500–505, 682, 684–694, D9/719, 772–777, 516, 517, 520, 526, D9/537–540, 545, 549–558, 565, 448; 215/370, 372, 373, 376, 379, 382, 386, 215/395; 220/600, 601, 604–606, 608, 220/610–613, 623, 625, 628, 630, 633, 635, 220/669, 672, 677, 694, 729, 737; 222/183, 222/184, 321.5, 377, 464.7
CPC B65D 1/0223; B65D 1/0261; B65D 1/06; B65D 23/00; B65D 23/001; B65D 23/003; B65D 2231/00; B65D 2231/008; B65D 2501/0018; B65D 83/14; B65D 83/38; B65D 83/32; B05B 11/00; B05B 11/0037; B05B 11/0059; B05B 11/303; B05B 11/3032; B05B 11/3045; B05B 11/3047; B05B 11/3057; B05B 11/3001; B05B 11/3002; B05B 11/3004; B05B 11/3005; B05B 11/3007; B05B 11/3008; B05B 11/3009; B05B 11/3011; B05B 11/3012; B05B 11/3014; B05B 11/3015; B05B 11/3016; B05B 11/3018; B05B 11/3019; B05B 11/3021; B05B 11/3022; B05B 11/3023; B05B 11/3025; B05B 11/3026; B05B 11/3028; B05B 11/3029; B05B 11/3033; B05B 11/3035; B05B 11/3036

See application file for complete search history.

(56) **References Cited**

U.S. PATENT DOCUMENTS

D128,406 S * 7/1941 Soontup et al. D9/502
2,917,197 A * 12/1959 Glover et al. 215/12.2
D198,871 S * 8/1964 Akelreb D9/539
D244,531 S * 5/1977 Klingaman D23/225

(Continued)

Primary Examiner — Catherine Tuttle

(57) **CLAIM**

The ornamental design for a spray bottle, as shown and described.

DESCRIPTION

FIG. 1 illustrates a front view of the claimed design for a spray bottle;
FIG. 2 illustrates a top view thereof;
FIG. 3 illustrates a right-side view thereof;
FIG. 4 illustrates a left-side view thereof;
FIG. 5 illustrates a bottom view thereof;
FIG. 6 illustrates a rear view thereof;
FIG. 7 illustrates a cross-sectional view thereof, taken along line 7-7 of FIG. 1;
FIG. 8 illustrates a perspective view thereof;
FIG. 9 illustrates a front view of the spray bottle shown separately from the dip tube and spray head for clarity;
FIG. 10 illustrates a top view thereof;
FIG. 11 illustrates a right-side view thereof;
FIG. 12 illustrates a left-side view thereof;
FIG. 13 illustrates a bottom view thereof;
FIG. 14 illustrates a rear view thereof;
FIG. 15 illustrates a cross-sectional view thereof, taken along line 7-7 of FIG. 9; and,
FIG. 16 illustrates a perspective view thereof.
The broken lines are included for the purpose of illustrating the portions of the spray bottle that form no part of the claimed design.

1 Claim, 16 Drawing Sheets

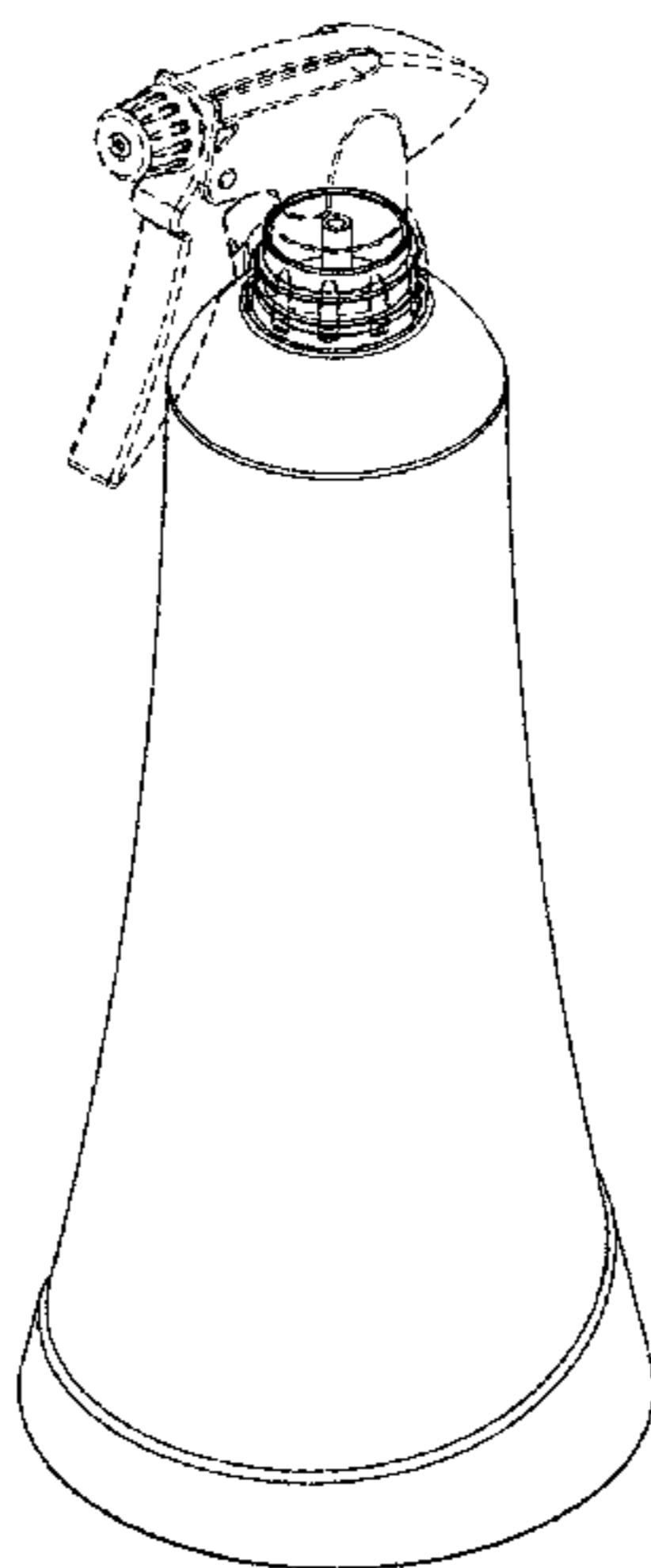

(56)

References Cited

U.S. PATENT DOCUMENTS

5,062,549 A * 11/1991 Smith et al. 222/377
D368,528 S * 4/1996 Allegre D24/197
D444,700 S * 7/2001 Ebert D9/685
D472,147 S * 3/2003 Herrmann D9/504
D501,133 S * 1/2005 Schuller et al. D9/689
D530,215 S * 10/2006 Brown et al. D9/558
D541,167 S * 4/2007 Matsumura et al. D9/558
D542,135 S * 5/2007 Machmadow D9/503
D551,560 S * 9/2007 De Baschmakoff D9/558
D569,264 S * 5/2008 Yamanaka et al. D9/691

D704,069 S * 5/2014 Handy D9/685
D715,153 S * 10/2014 Hansen D9/685
2002/0030116 A1 * 3/2002 Brown 239/59
2003/0066843 A1 * 4/2003 Schwartz 222/377
2006/0144868 A1 * 7/2006 Brisbois et al. 222/377
2008/0023499 A1 * 1/2008 Knight 222/464.7
2008/0035668 A1 * 2/2008 Foster 222/1
2009/0008414 A1 * 1/2009 Tingsley 222/377
2011/0067576 A1 * 3/2011 White et al. 99/323.1
2012/0056016 A1 * 3/2012 Fritsch et al. 239/302
2013/0098944 A1 * 4/2013 Broadney 222/321.9
2013/0284764 A1 * 10/2013 Baxter-Waller 222/321.9

* cited by examiner

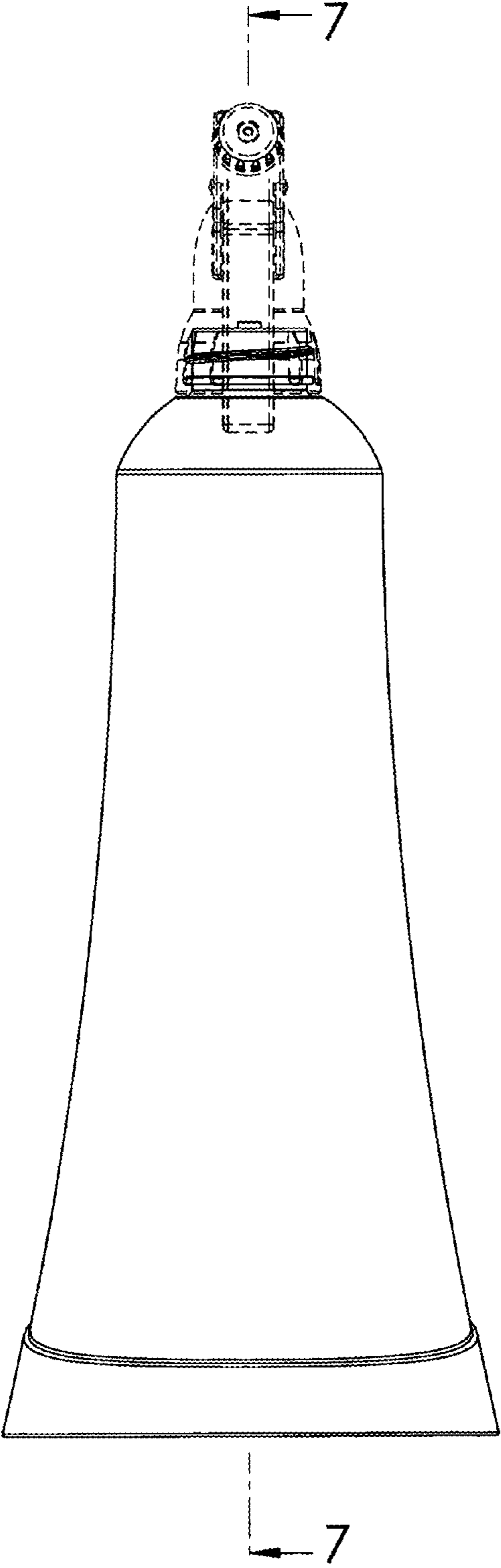

FIG. 1

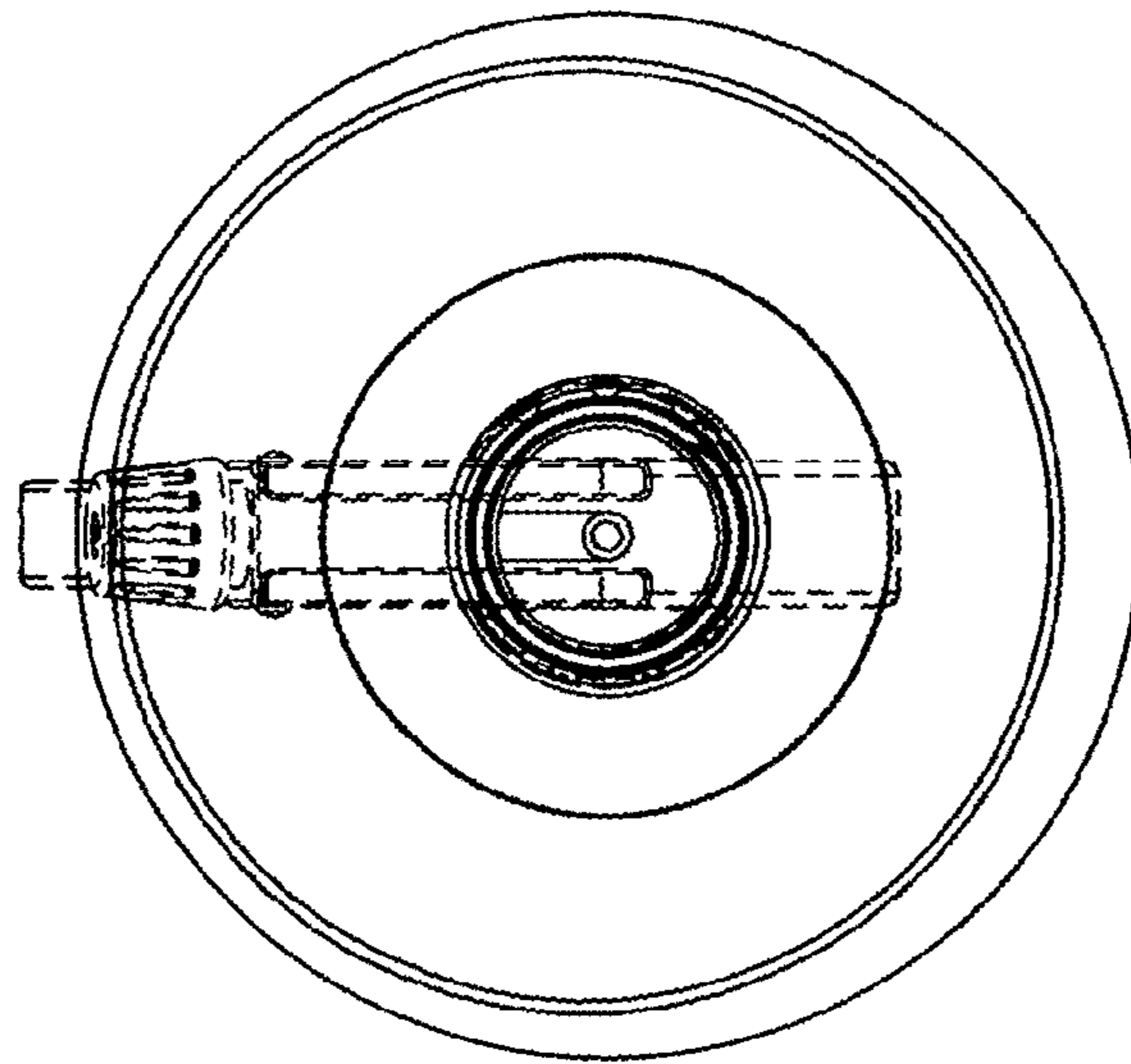

FIG. 2

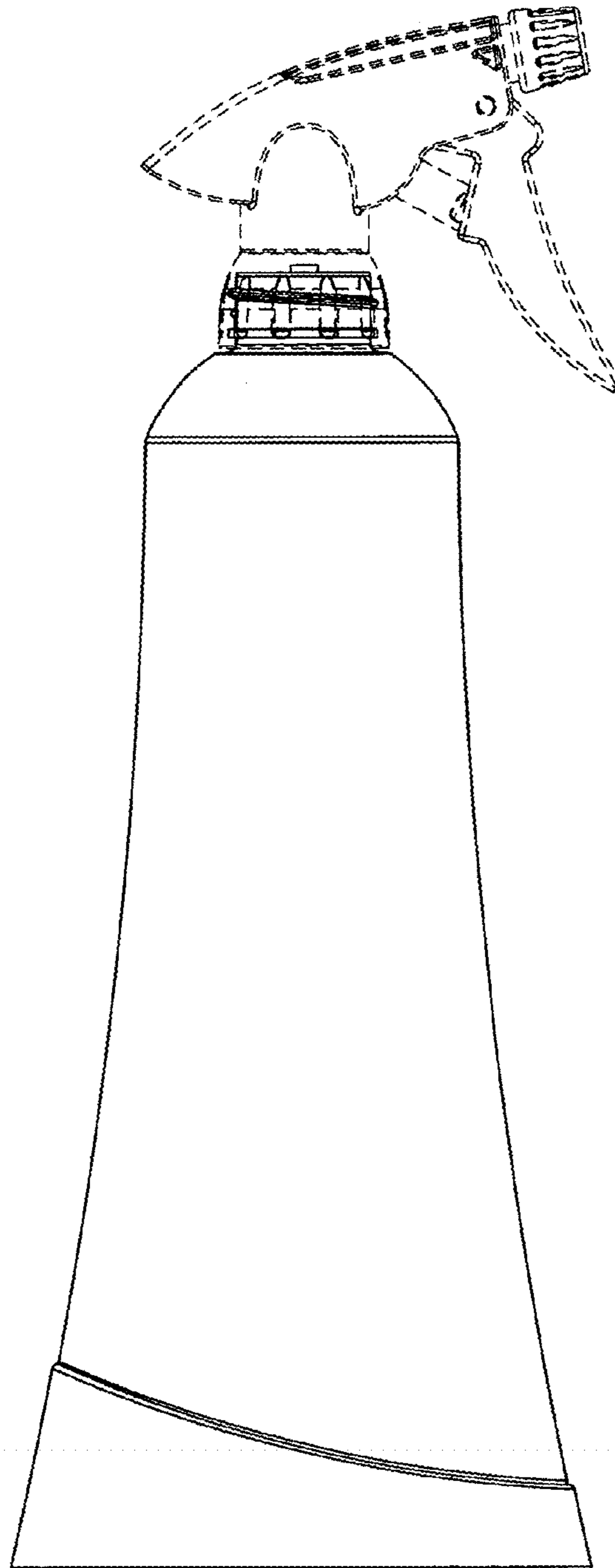

FIG. 3

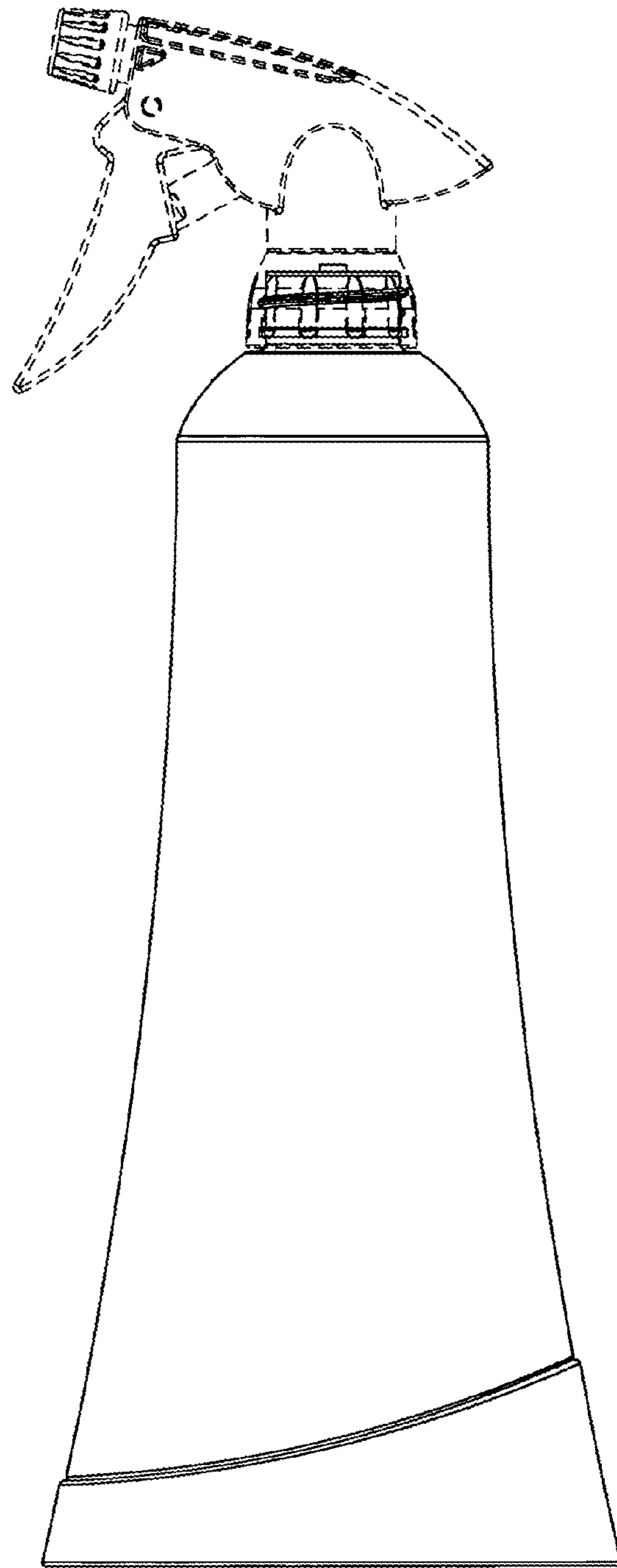

FIG. 4

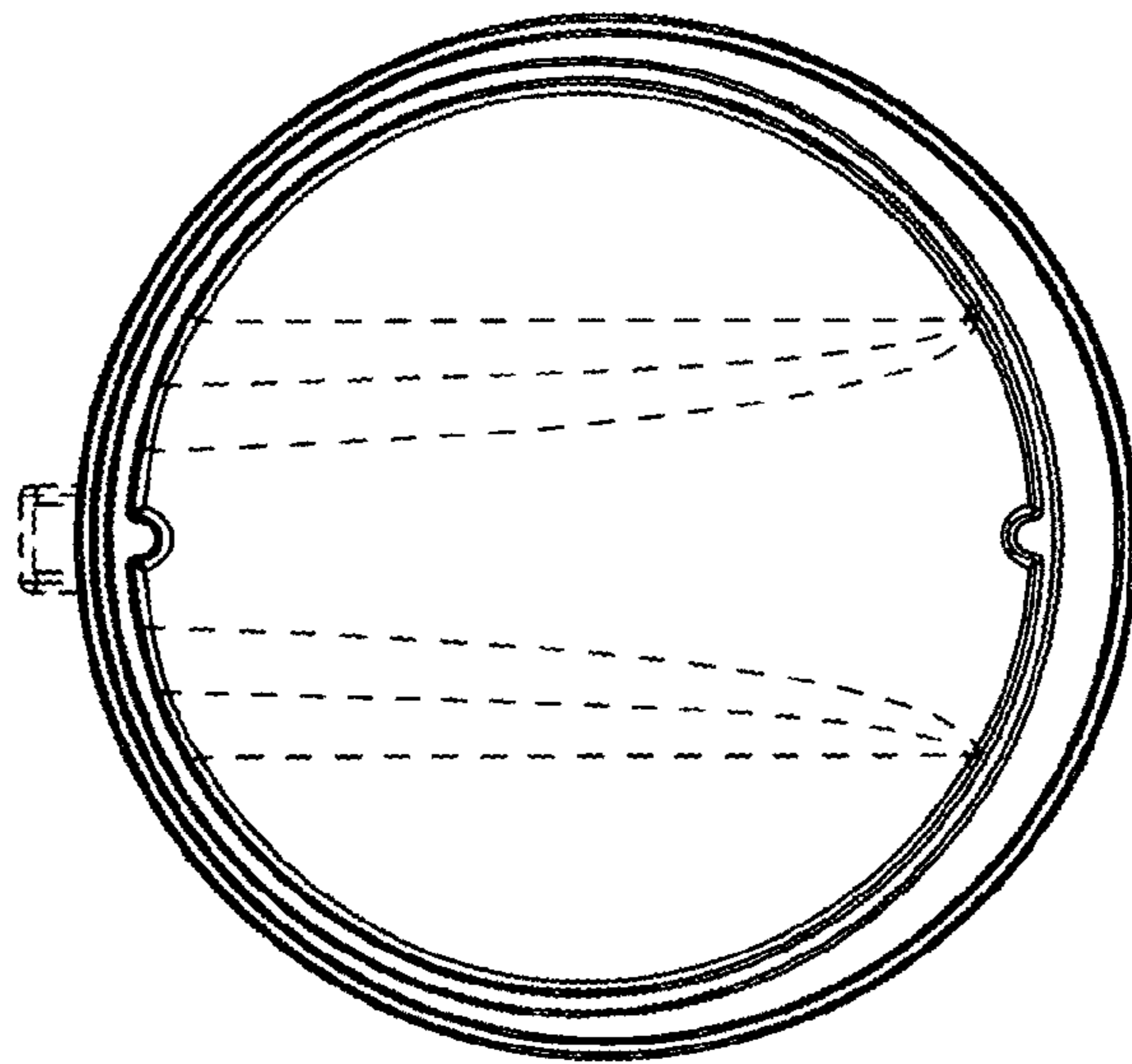

FIG. 5

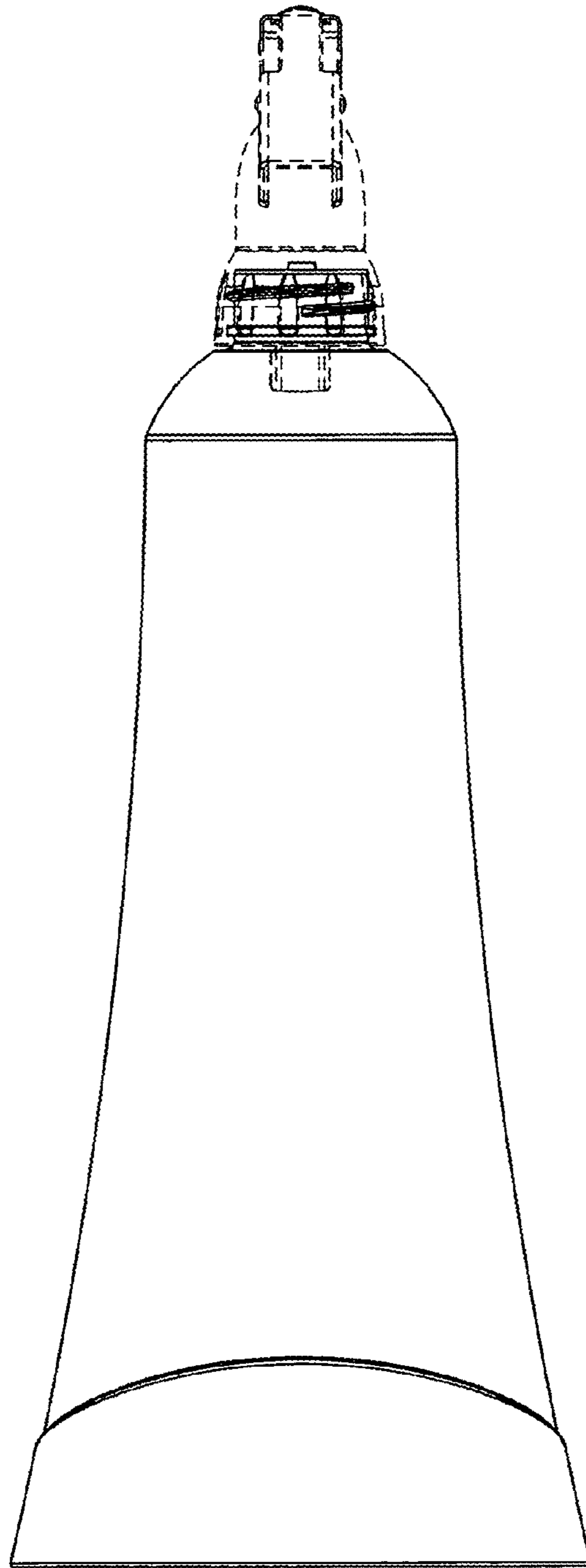

FIG. 6

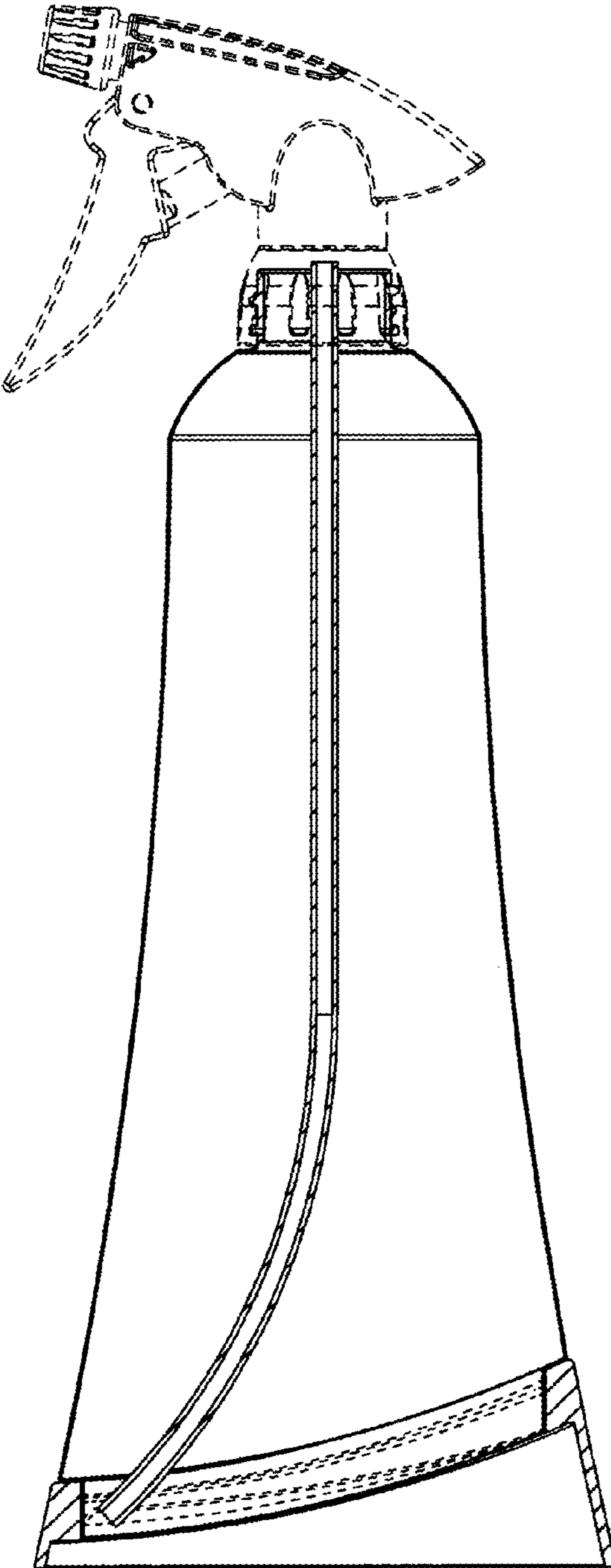

FIG. 7

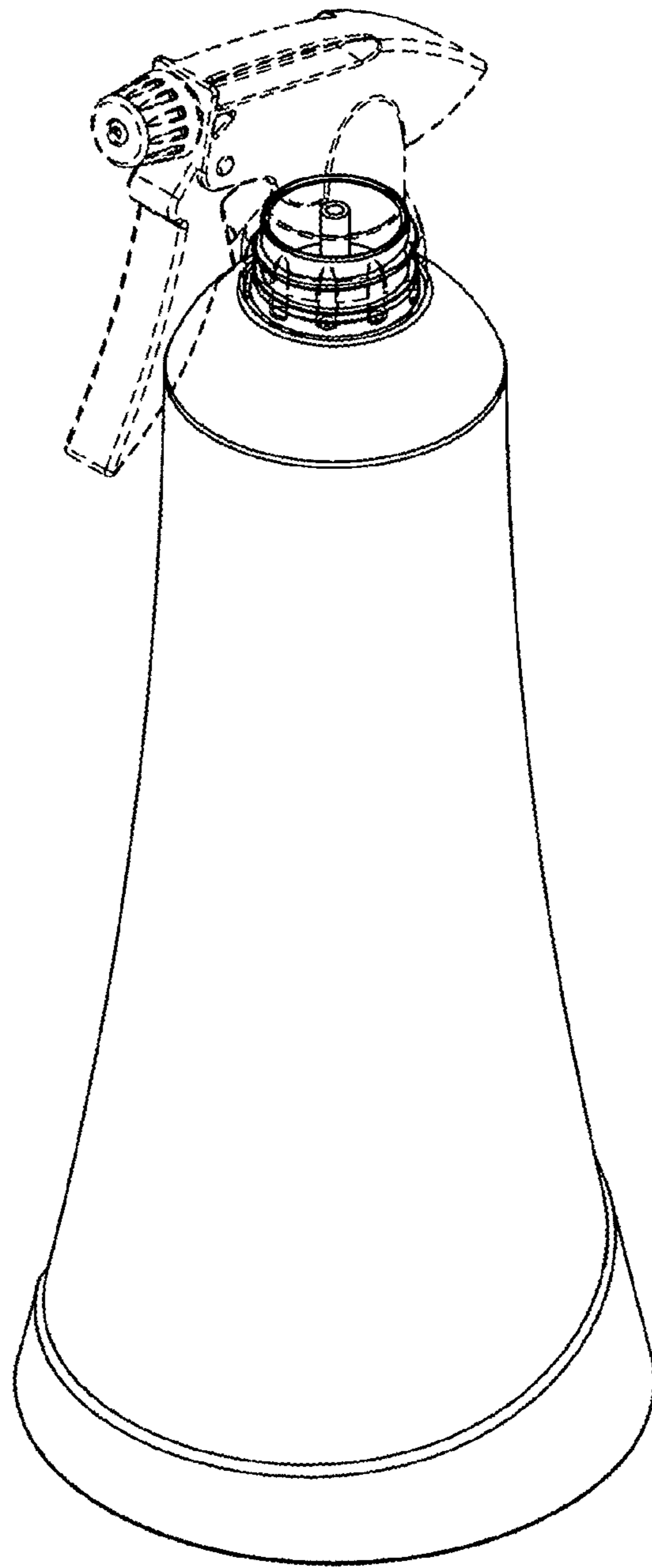

FIG. 8

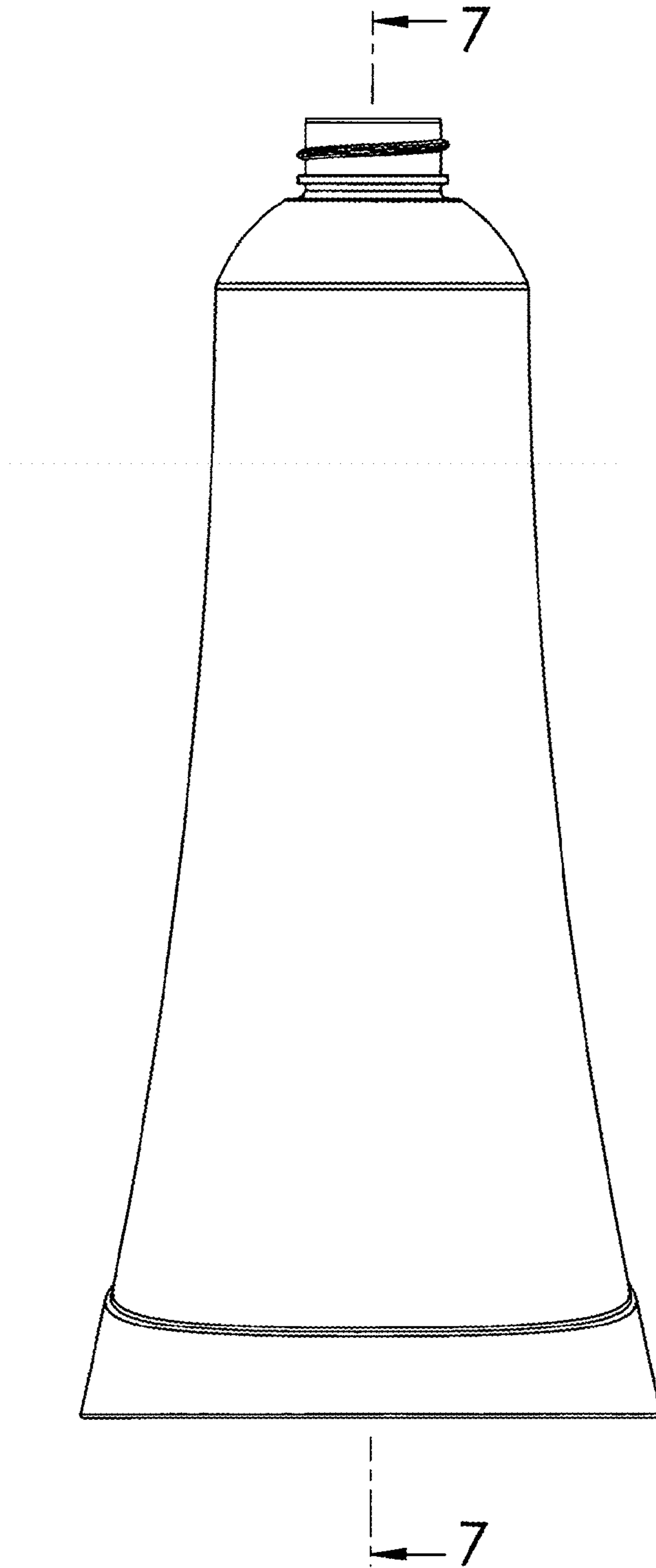

FIG. 9

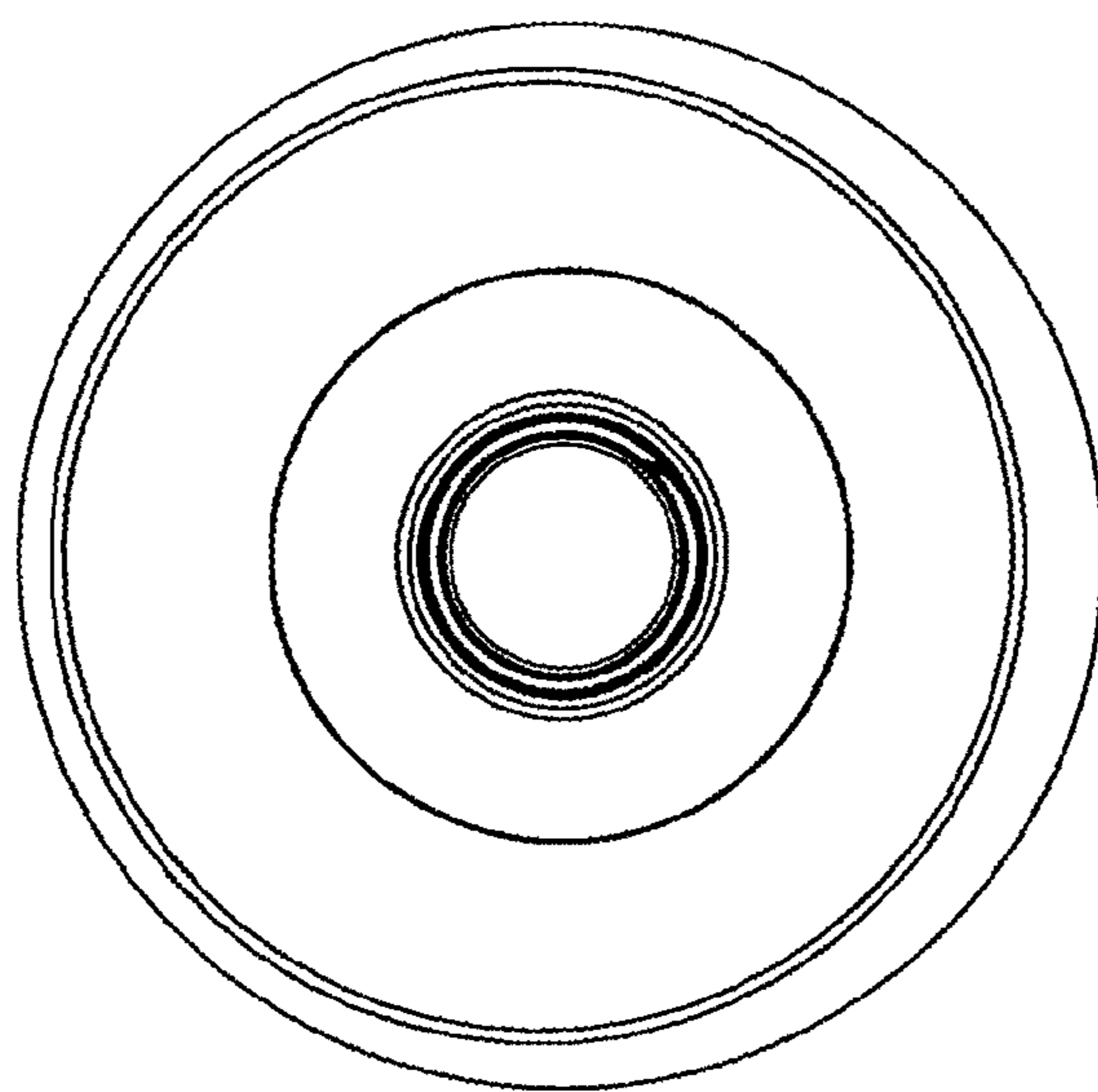

FIG. 10

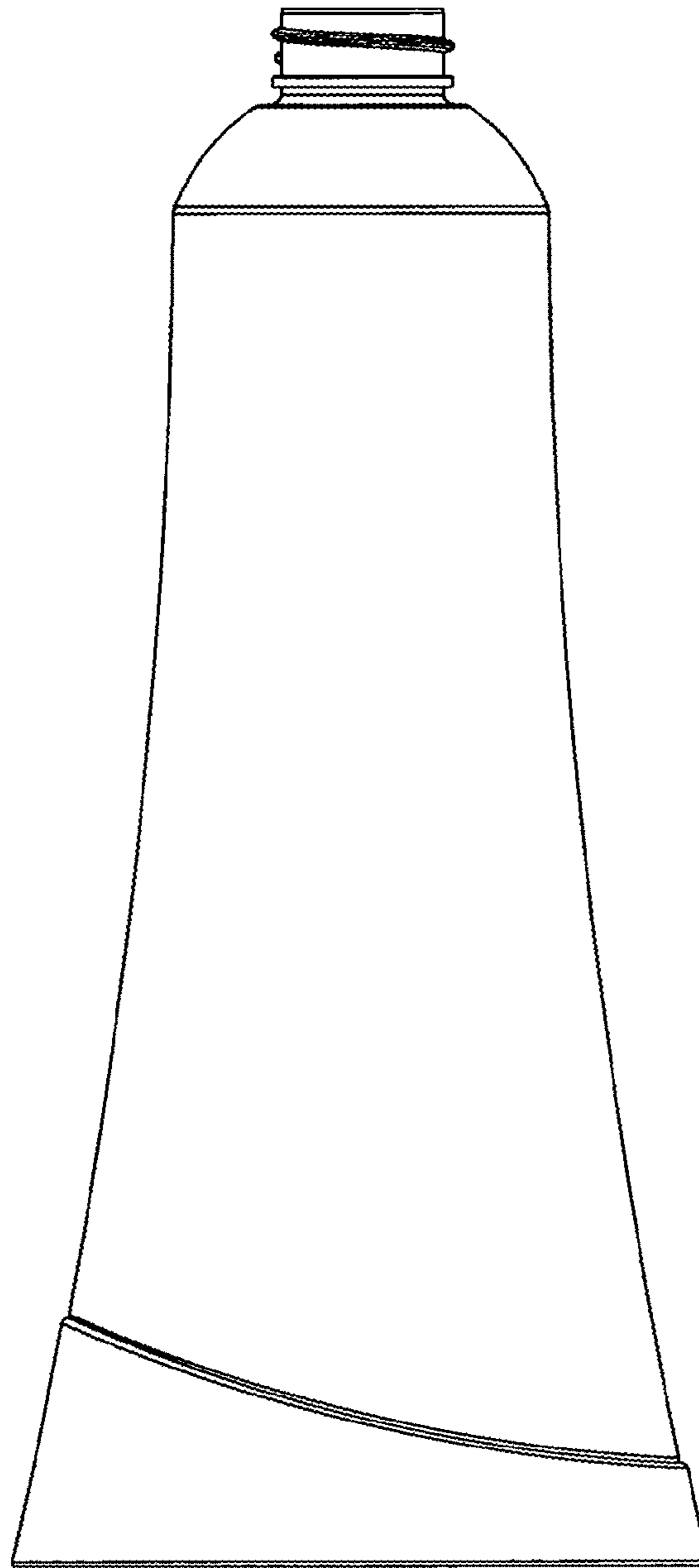

FIG. 11

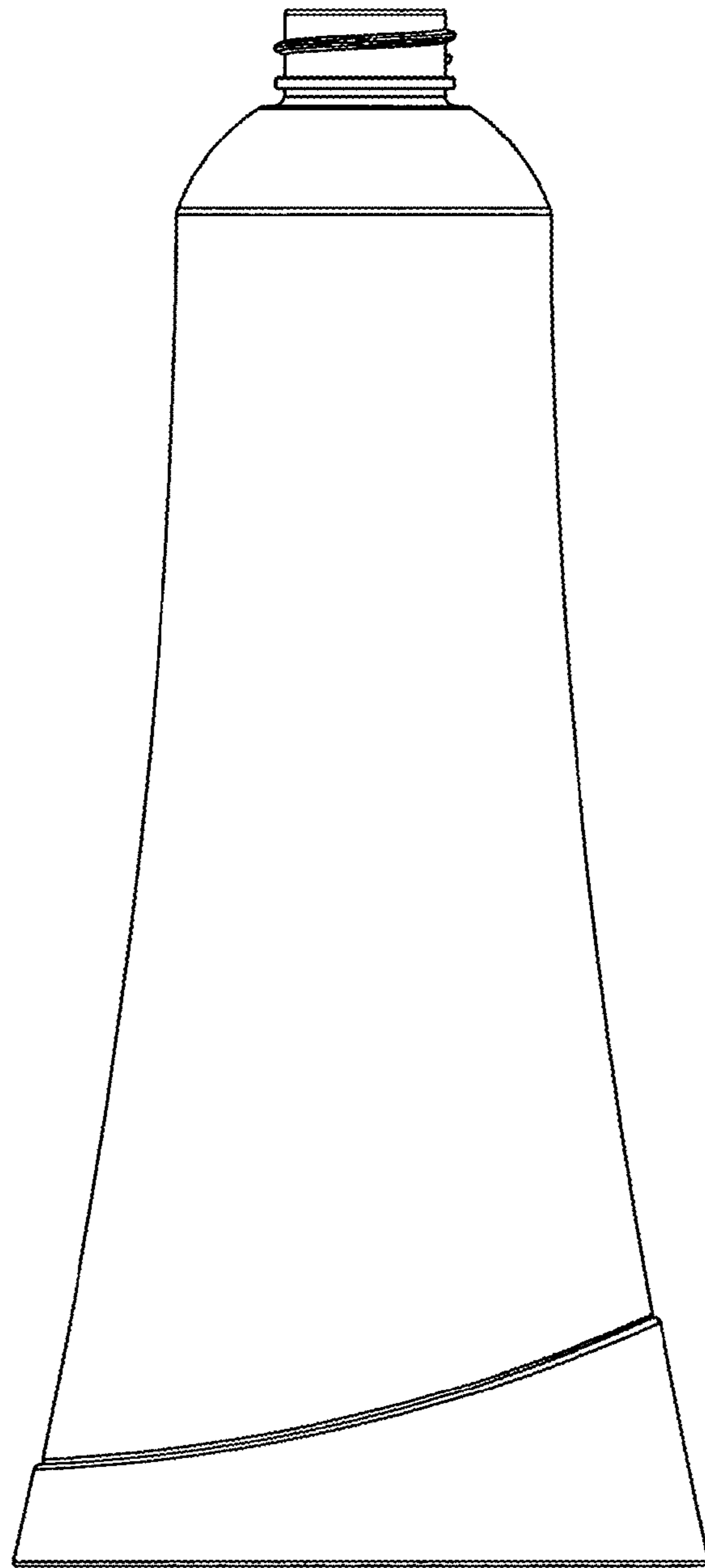

FIG. 12

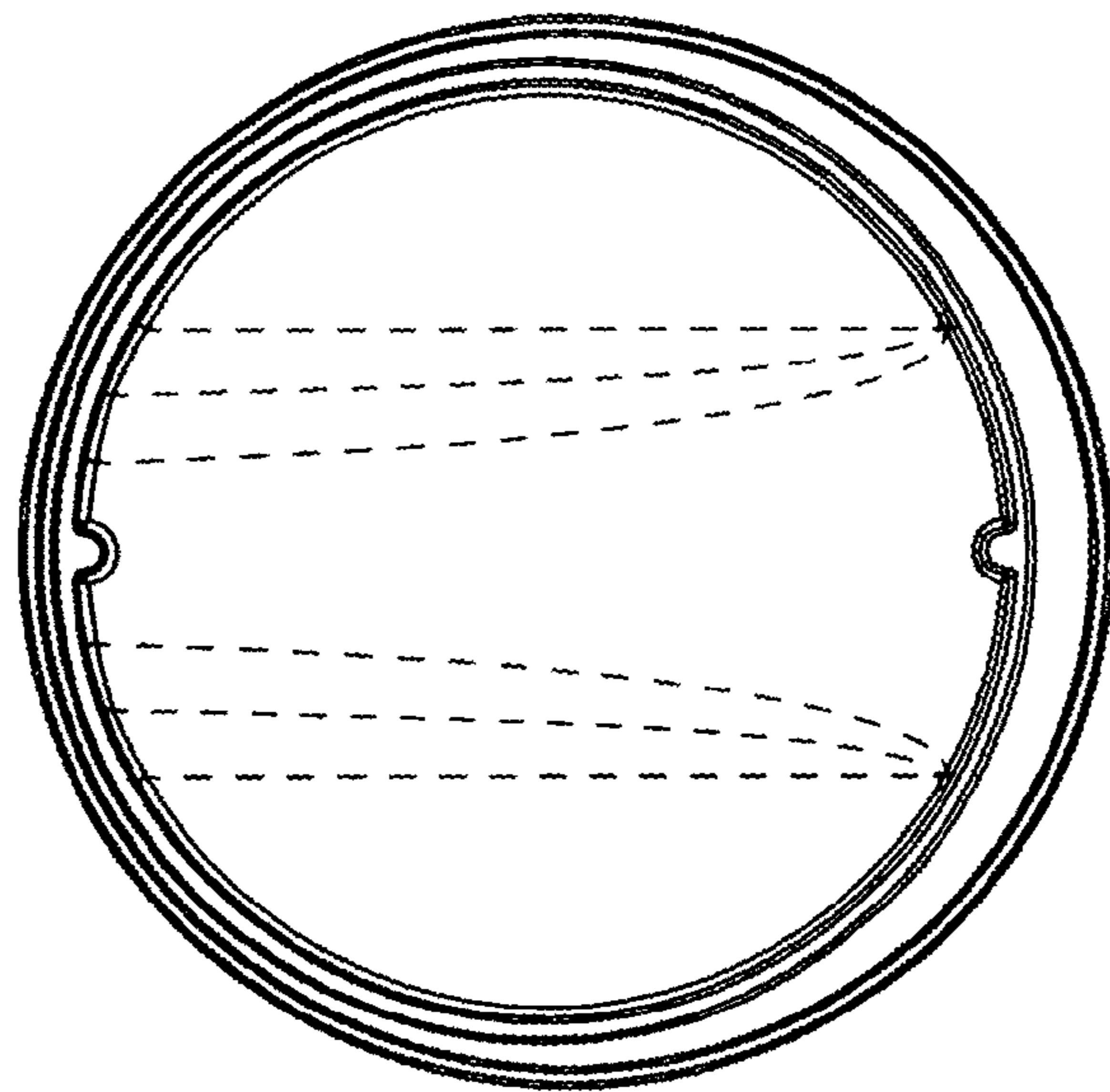

FIG. 13

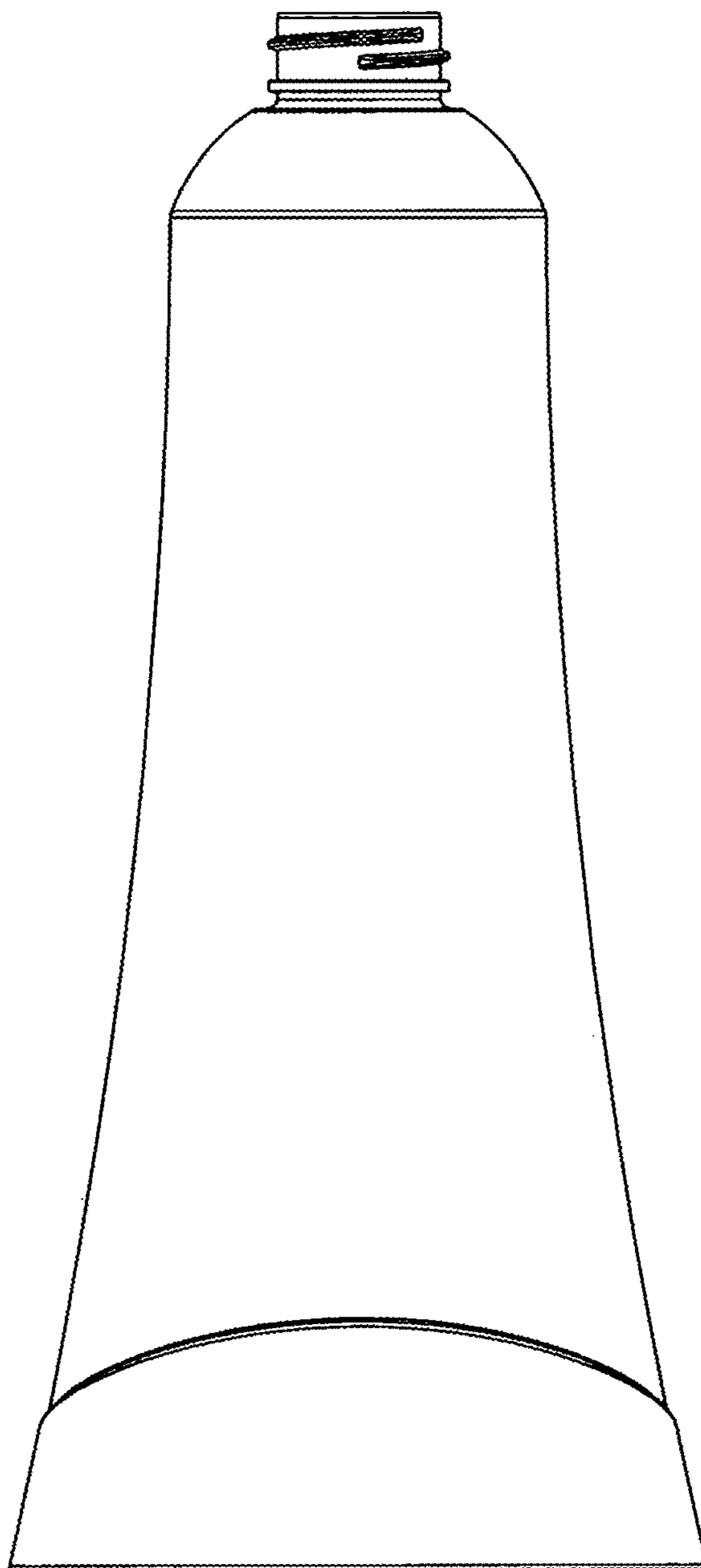

FIG. 14

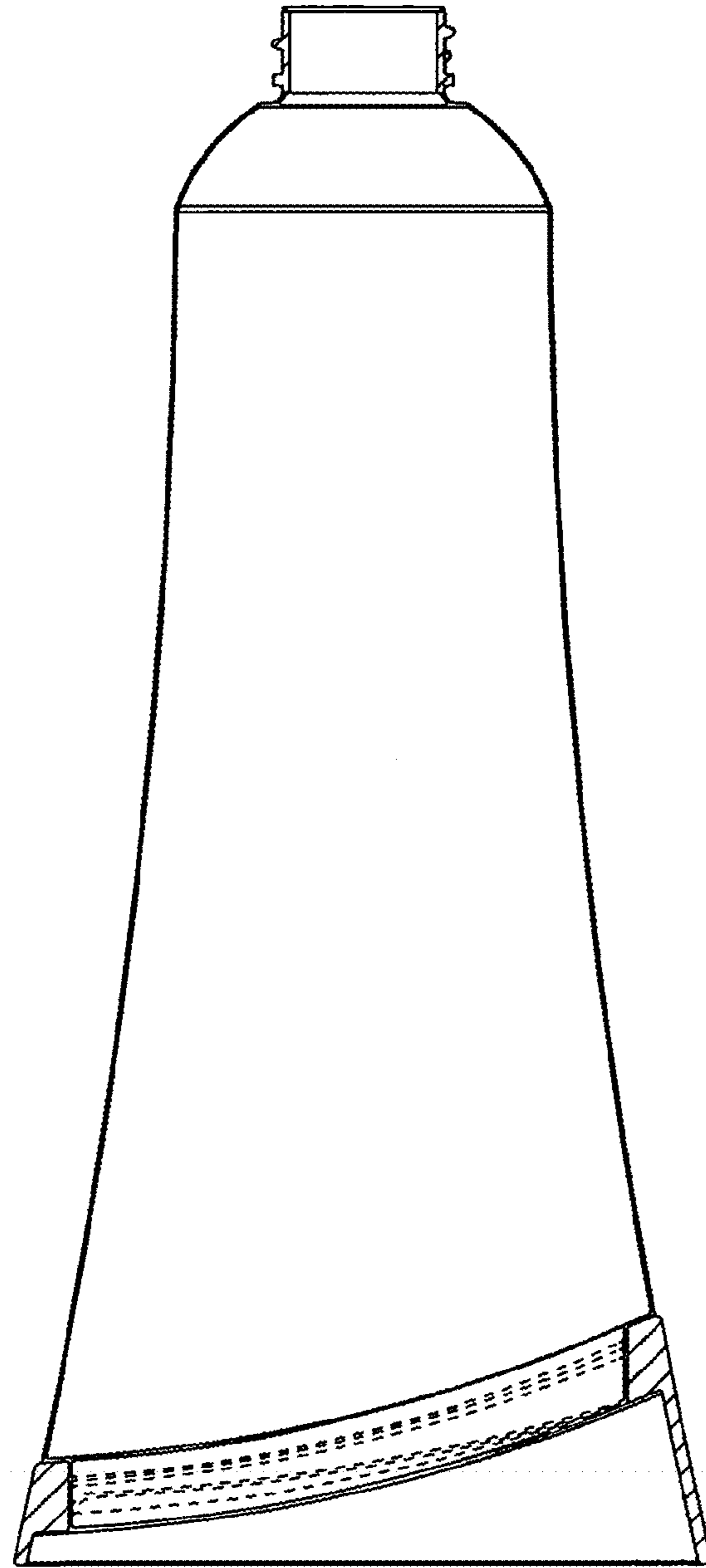

FIG. 15

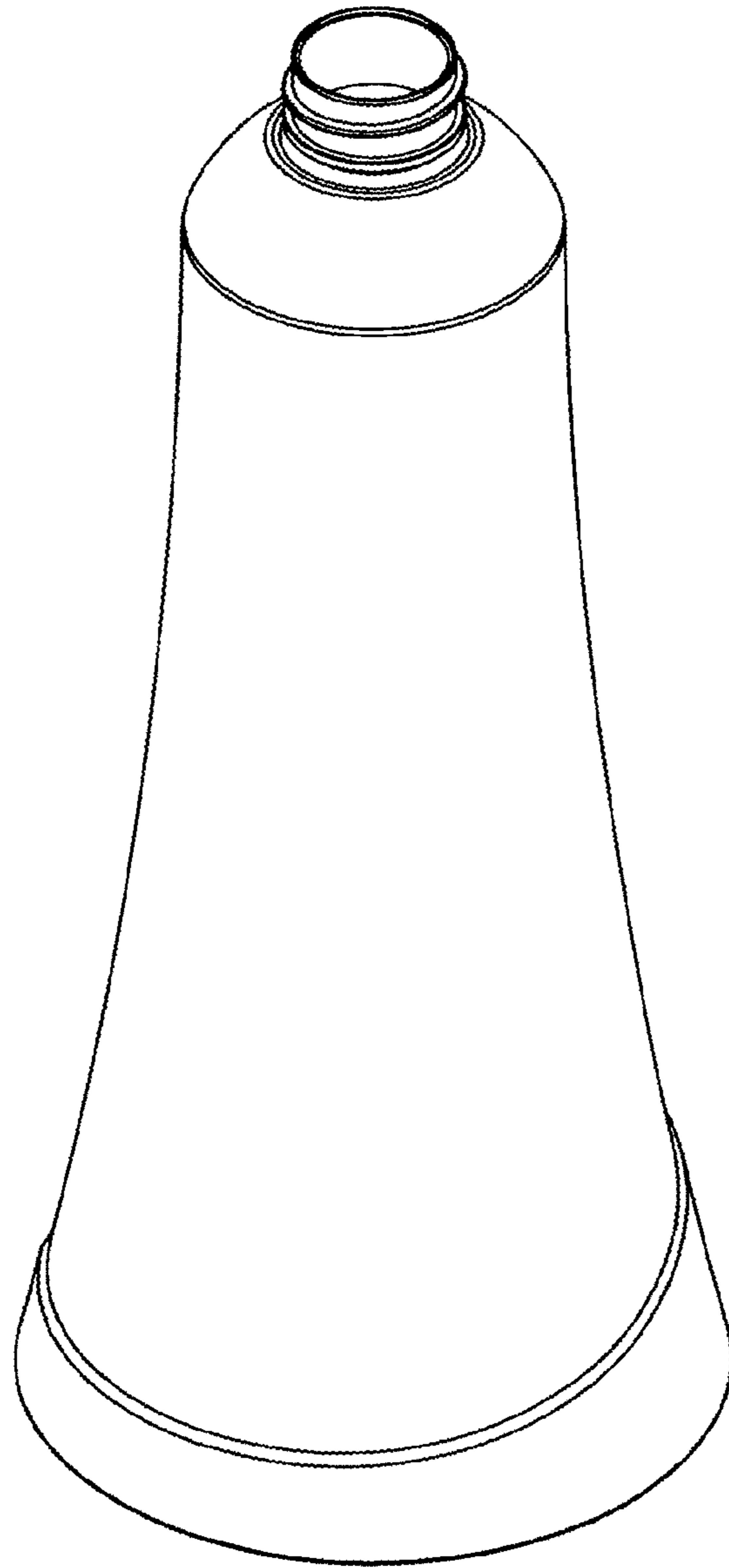

FIG. 16