



US00D742658S

(12) **United States Design Patent**  
**Bisman et al.**

(10) **Patent No.:** **US D742,658 S**  
(45) **Date of Patent:** **\*\* Nov. 10, 2015**

(54) **CHAIR**  
(71) Applicant: **FORMWAY FURNITURE LIMITED**,  
Seaview, Lower Hutt (NZ)  
(72) Inventors: **Christopher Warren Bisman**, Porirua  
(NZ); **Stuart Gregory Munro**, Lower  
Hutt (NZ)  
(73) Assignee: **Formway furniture Limited**, Lower  
Hutt (NZ)

D550,465 S 9/2007 Bouroullec et al.  
D552,362 S \* 10/2007 Bouroullec et al. .... D6/369  
D554,872 S 11/2007 Wimberger  
D582,173 S \* 12/2008 Dordoni ..... D6/369  
D596,864 S \* 7/2009 Bergmann et al. .... D6/375  
D607,225 S \* 1/2010 Bauchet ..... D6/375  
D628,399 S 12/2010 Gauthier  
D638,229 S 5/2011 Lewis  
D646,510 S \* 10/2011 Gasser ..... D6/716  
D690,953 S \* 10/2013 Alken ..... D6/380

(\*\*) Term: **14 Years**

(21) Appl. No.: **29/485,510**

(22) Filed: **Mar. 19, 2014**

(51) **LOC (10) Cl.** ..... **06-01**

(52) **U.S. Cl.**  
USPC ..... **D6/374**

(58) **Field of Classification Search**  
USPC ..... D6/334-336, 369, 371, 372, 373, 374,  
D6/375, 380, 376, 716, 716.1, 716.4  
CPC ..... A47C 3/04; A47C 4/02; A47C 4/03;  
A47C 5/04; A47C 5/06; A47C 5/12; A47C  
7/18; B60N 2/70  
See application file for complete search history.

(56) **References Cited**

**U.S. PATENT DOCUMENTS**

3,521,929 A \* 7/1970 Pearson ..... A47C 7/18  
D380,096 S 6/1997 Hanig  
D386,910 S \* 12/1997 Saiger ..... D6/334  
D393,956 S \* 5/1998 Kane ..... D6/374  
D466,313 S 12/2002 Hutton  
D539,046 S 3/2007 Bouroullec et al.  
D550,464 S 9/2007 Bauchet

**FOREIGN PATENT DOCUMENTS**

EM 001020846-0001 10/2008  
EM 001020846-0002 10/2008  
EM 001020846-0003 10/2008  
FR 012452-006 9/2001  
FR 20102755-002 1/2011  
RU 71521 S 8/2009

\* cited by examiner

*Primary Examiner* — Mimoso De

(74) *Attorney, Agent, or Firm* — Workman Nydegger

(57) **CLAIM**

The ornamental design for a chair, as shown and described.

**DESCRIPTION**

FIG. 1 is a perspective view of a chair showing our new design;

FIG. 2 is a front elevational view thereof;

FIG. 3 is a rear elevational view thereof;

FIG. 4 is a left side elevational view thereof;

FIG. 5 is a right side elevational view thereof; and,

FIG. 6 is a top plan view thereof.

The broken lines showing the wheels are for the purpose of illustration and form no part of the claimed design.

**1 Claim, 6 Drawing Sheets**

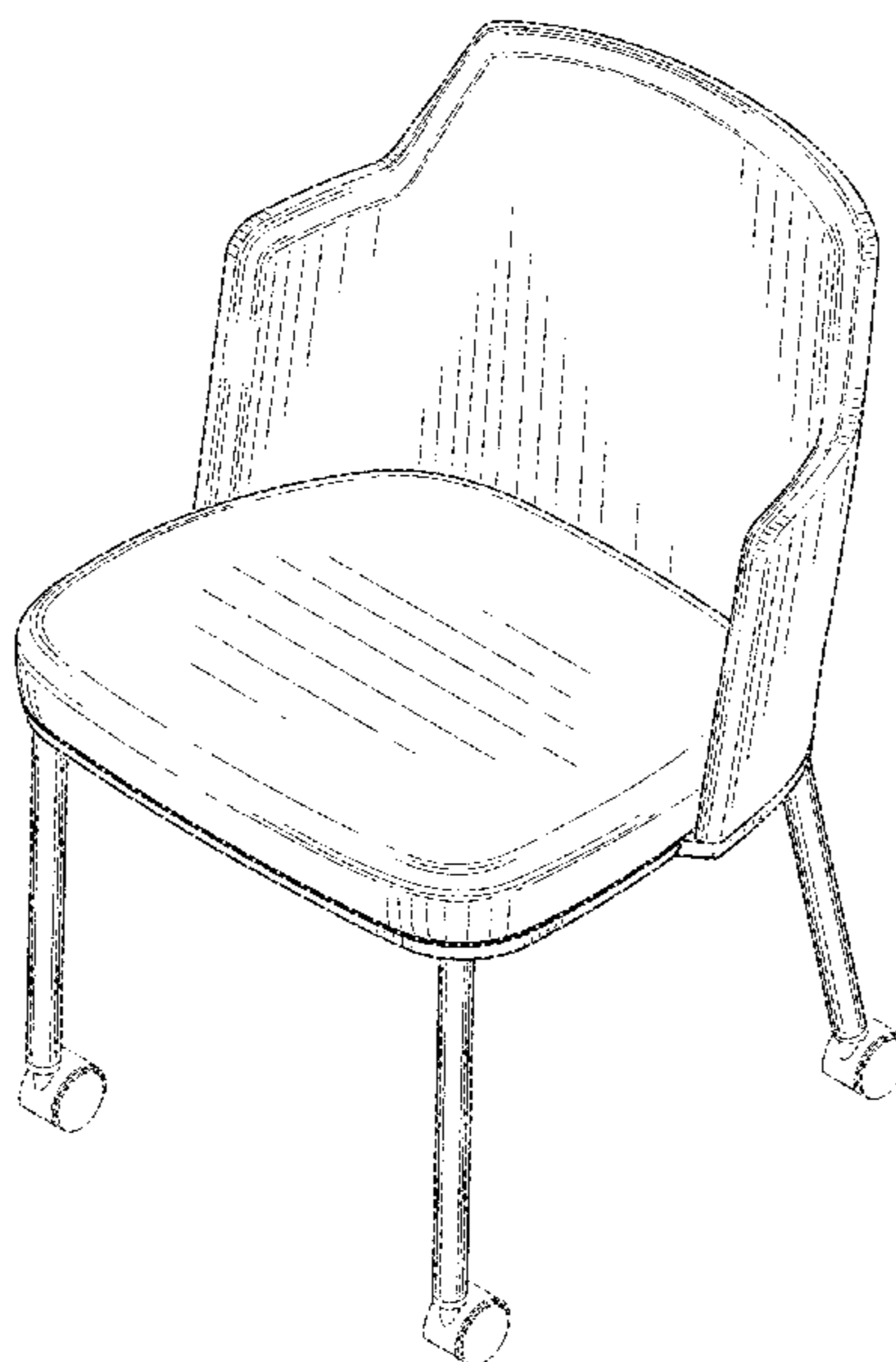

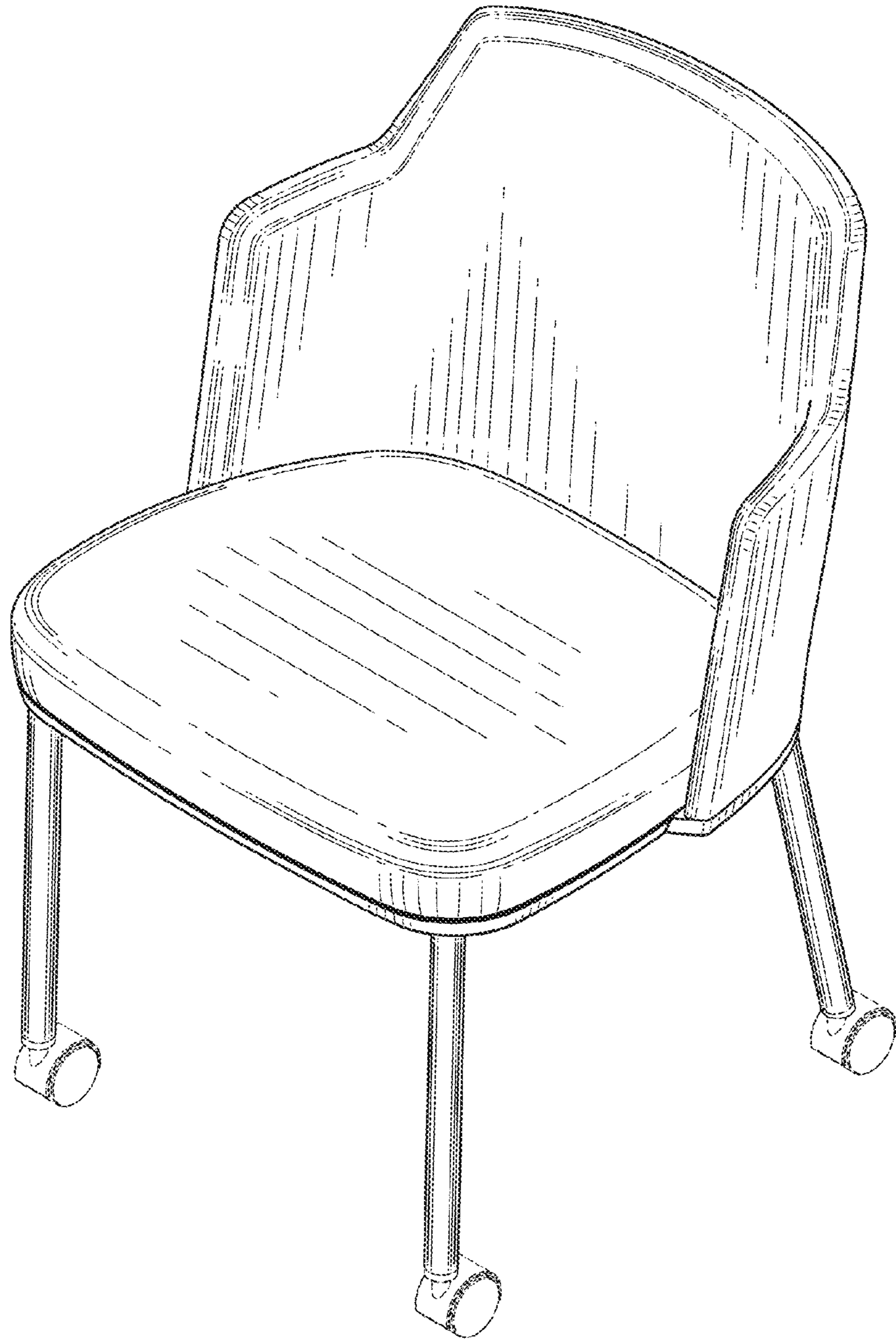

**FIGURE 1**

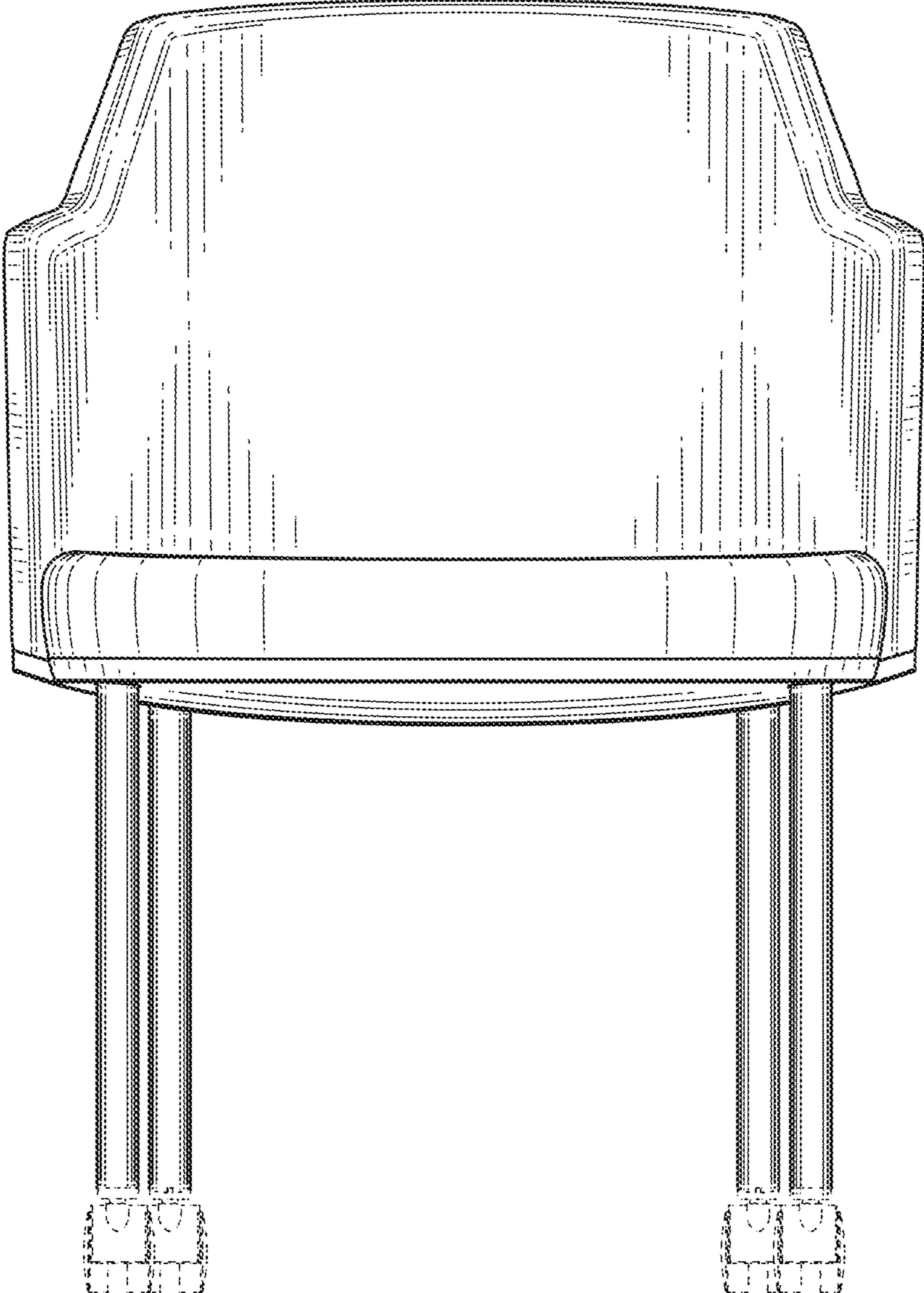

FIGURE 2

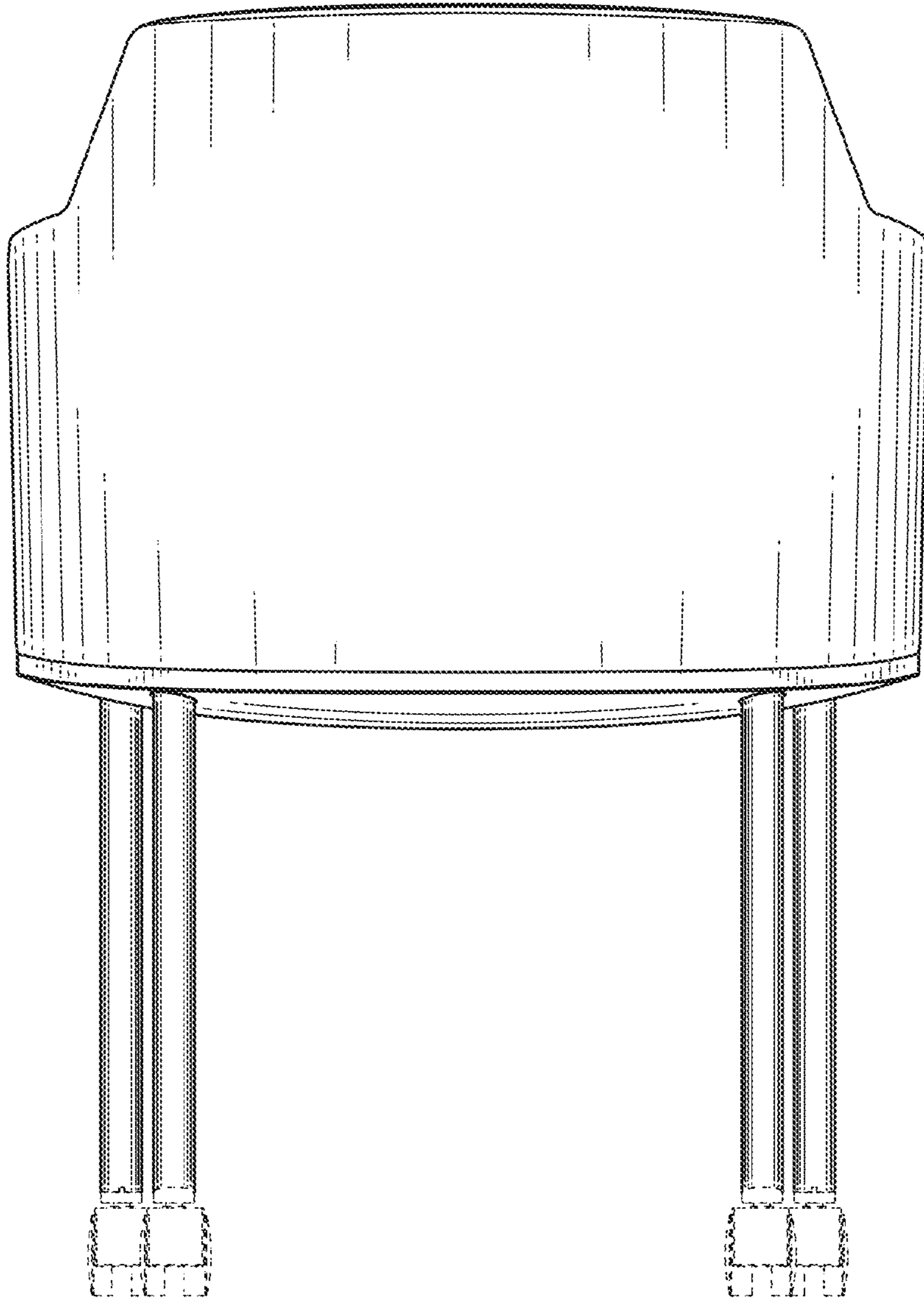

FIGURE 3

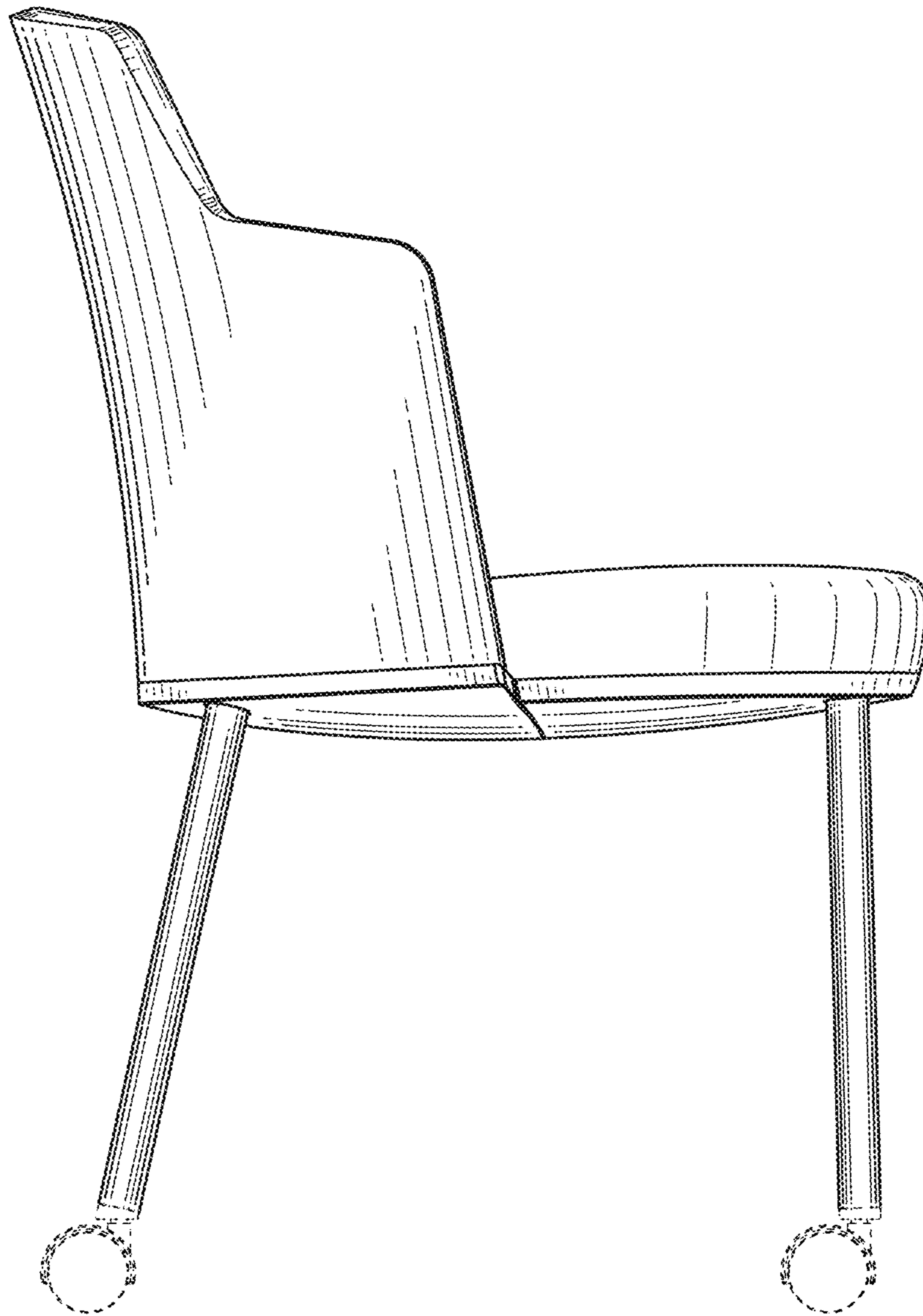

FIGURE 4

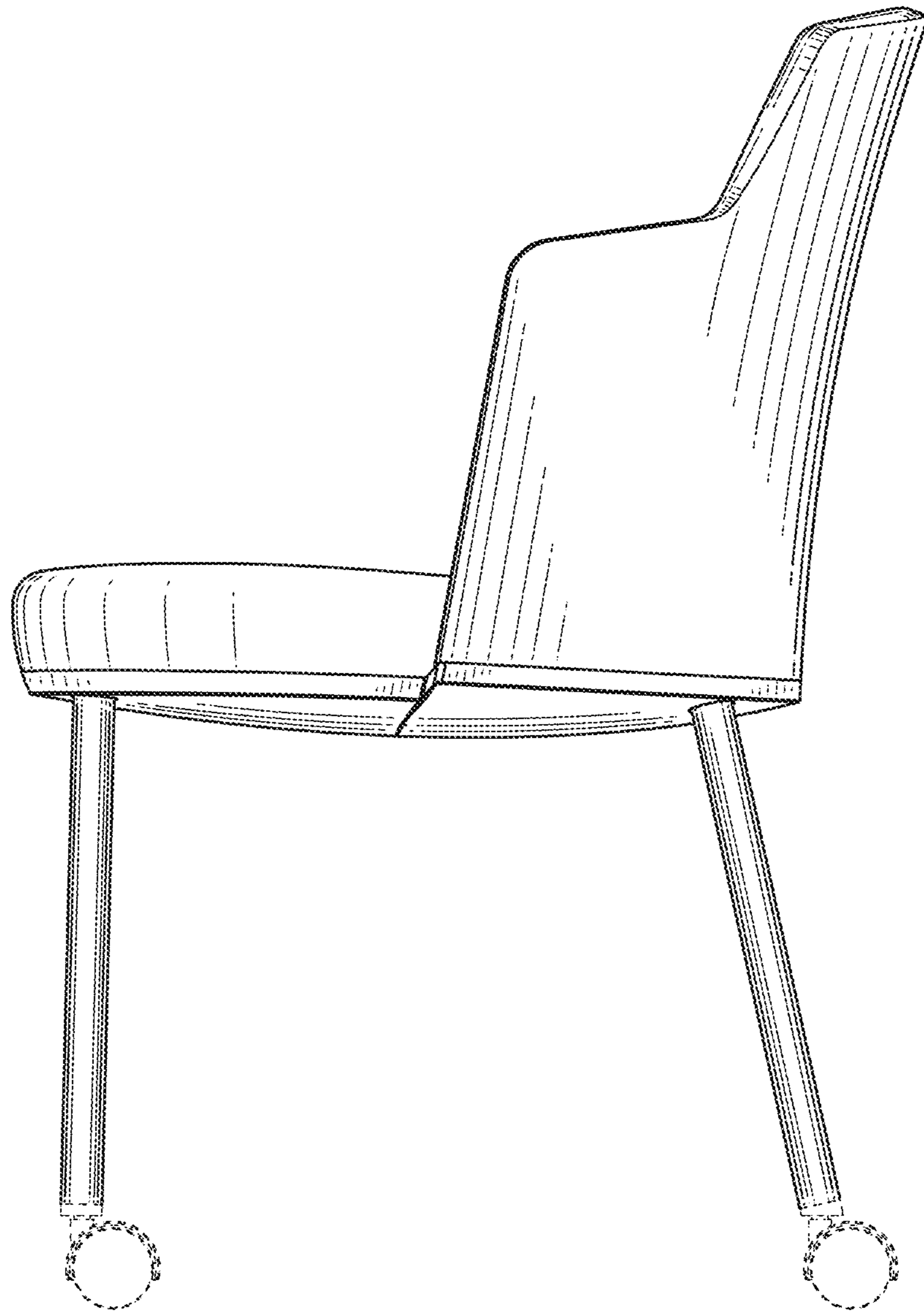

FIGURE 5

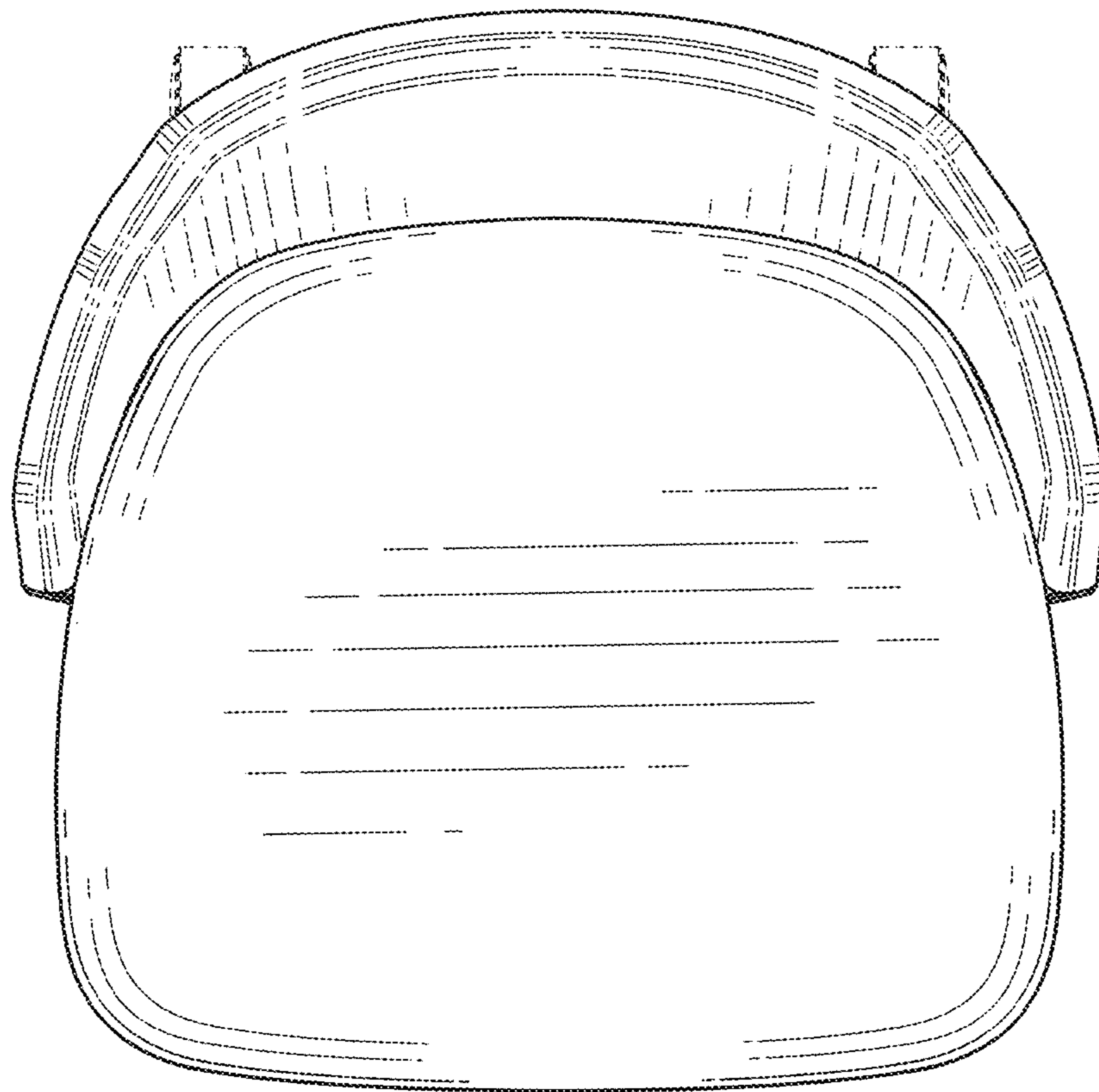

FIGURE 6