



US00D742593S

(12) **United States Design Patent**
Corey et al.

(10) **Patent No.:** **US D742,593 S**
(45) **Date of Patent:** **** Nov. 3, 2015**

(54) **COSMETIC CONTAINER**

(56)

References Cited

(71) Applicant: **The Mentholatum Company**, Orchard Park, NY (US)

U.S. PATENT DOCUMENTS

(72) Inventors: **Christopher A. Corey**, Orchard Park, NY (US); **Kevin J. Aylsworth**, Orchard Park, NY (US); **Shinjan Xie**, Torrance, CA (US); **Charles M. Smith**, East Aurora, NY (US); **Katherine Tocheff**, Orchard Park, NY (US); **D'Anna Farrar**, Williamsville, NY (US); **Raymond L. Lewis, Jr.**, Belchertown, MA (US)

1,636,251 A	7/1927	Shields	
D85,363 S	10/1931	Betts	
1,852,455 A	4/1932	Friedman	
3,351,186 A	11/1967	Betts	
D241,013 S	* 8/1976	Dekker	D9/529
D243,069 S	1/1977	Igelman	
D244,085 S	* 4/1977	Giddings et al.	D9/432
D246,129 S	10/1977	Klamer	
D247,104 S	* 1/1978	Novel	D11/131
D259,398 S	6/1981	Shiffman	
D259,399 S	6/1981	Shiffman	
D269,467 S	* 6/1983	Mann	D28/73
D271,180 S	11/1983	Runyon	
D272,605 S	2/1984	Pelletier	
4,765,501 A	8/1988	Kao	
4,811,726 A	* 3/1989	Goncalves et al.	601/154
D306,694 S	3/1990	Beier-Rosetti	
D306,933 S	* 4/1990	Holewinski	D9/529
D306,973 S	* 4/1990	Kaplan	D3/294
D308,939 S	7/1990	Desgrippes	
D317,717 S	* 6/1991	Carol	D9/739
D320,933 S	10/1991	Courtiere et al.	
D324,172 S	2/1992	Mederer	
D327,423 S	* 6/1992	Turner-Adams	D9/655
5,326,185 A	7/1994	Dornbusch et al.	
D349,976 S	* 8/1994	Connell	D28/76
5,396,913 A	3/1995	Wallschlaeger	
5,496,122 A	3/1996	Fattori	
D368,430 S	4/1996	Herzog	
5,542,561 A	8/1996	Slink et al.	
5,547,072 A	8/1996	Kaiser	
D377,757 S	2/1997	Bertolini et al.	
5,598,929 A	2/1997	Jensen et al.	
5,609,430 A	3/1997	Mazzola et al.	
5,738,123 A	4/1998	Szekely	
5,826,741 A	10/1998	Dumler et al.	
5,875,795 A	3/1999	Bouix	
5,875,918 A	3/1999	Sheffler et al.	
5,888,004 A	3/1999	Bouix	
D408,738 S	* 4/1999	Wu	D9/503
5,896,866 A	4/1999	Quenessen	
5,931,169 A	* 8/1999	Kervoalen	132/294
D413,799 S	9/1999	Schlatter	
6,006,937 A	12/1999	Baravaglio et al.	
6,039,053 A	3/2000	Turrentine	
6,050,438 A	4/2000	Kovens et al.	
6,102,209 A	8/2000	D'Andrea	
D436,532 S	1/2001	Richardson	
D438,297 S	2/2001	Audebourg	

(73) Assignee: **THE MENTHOLATUM COMPANY**, Orchard Park, NY (US)

(**) Term: **14 Years**

(21) Appl. No.: **29/469,065**

(22) Filed: **Oct. 7, 2013**

(51) **LOC (10) Cl.** **28-03**

(52) **U.S. Cl.**
USPC **D28/85**; D28/83; D9/432; D9/726

(58) **Field of Classification Search**
USPC D28/76, 85-90, 77, 7, 83; 132/317, 132/318, 320; 206/581, 823; 401/68, 88, 401/98, 126-130; D9/726, 503, 504, 770, D9/432, 529, 424, 428, 551, 539, 561, 684, D9/546, 556, 559, 569, 553, 566, 519, 541, D9/542, 560, 438, 449, 721, 724, 733, 425, D9/423; D7/672, 374; D1/127; D23/366; D3/279, 901, 203.1-203.8, 2, 273, 903, D3/207, 211, 270, 304, 205, 302, 294, D3/271.1, 257, 245, 202, 212; D18/15, 16, D18/17; D19/108; D21/499, 500, 488, 501
CPC A45D 34/06; A45D 33/12; A45D 40/261; A45D 40/26; A45D 34/041; A45D 34/04
See application file for complete search history.

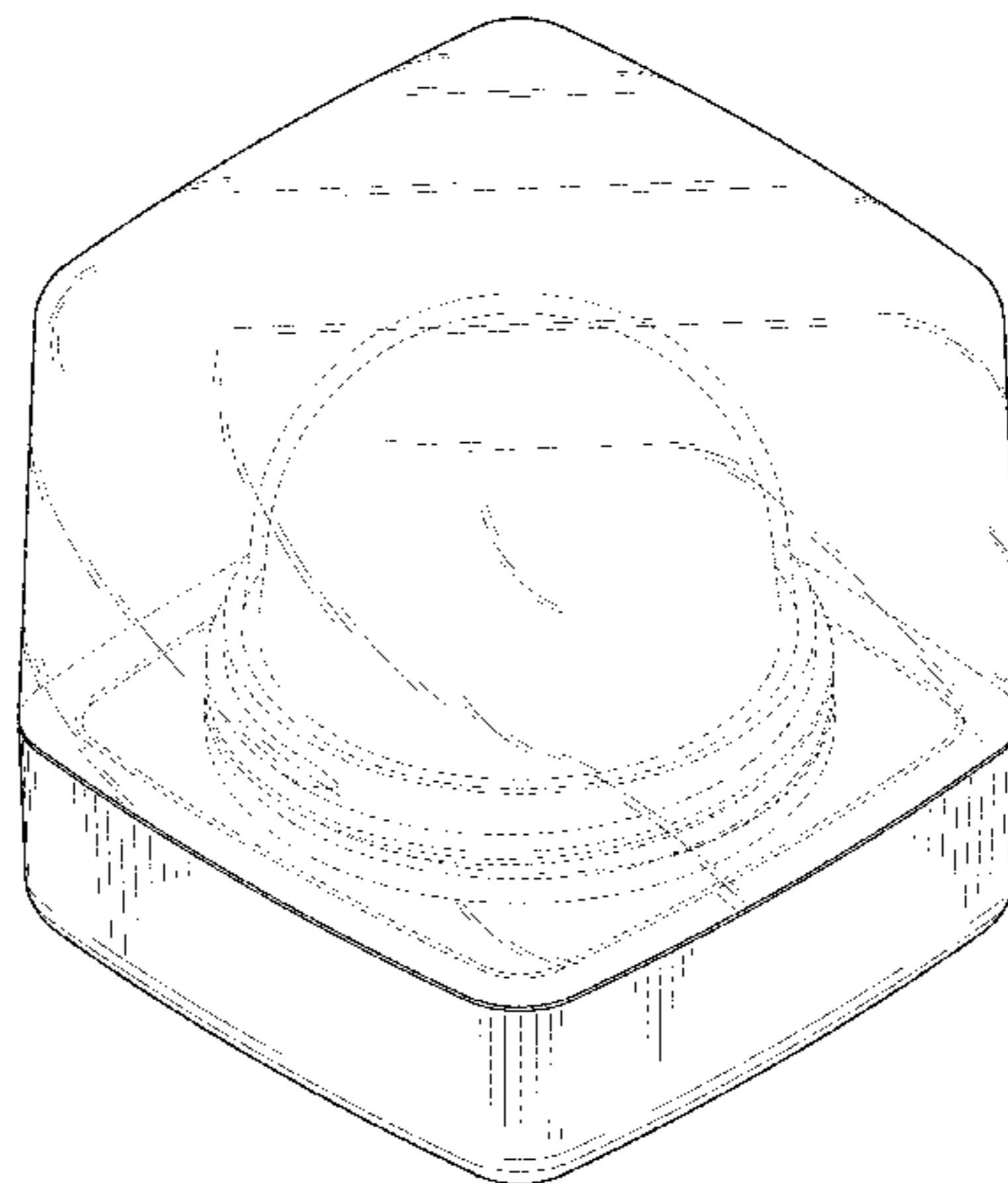
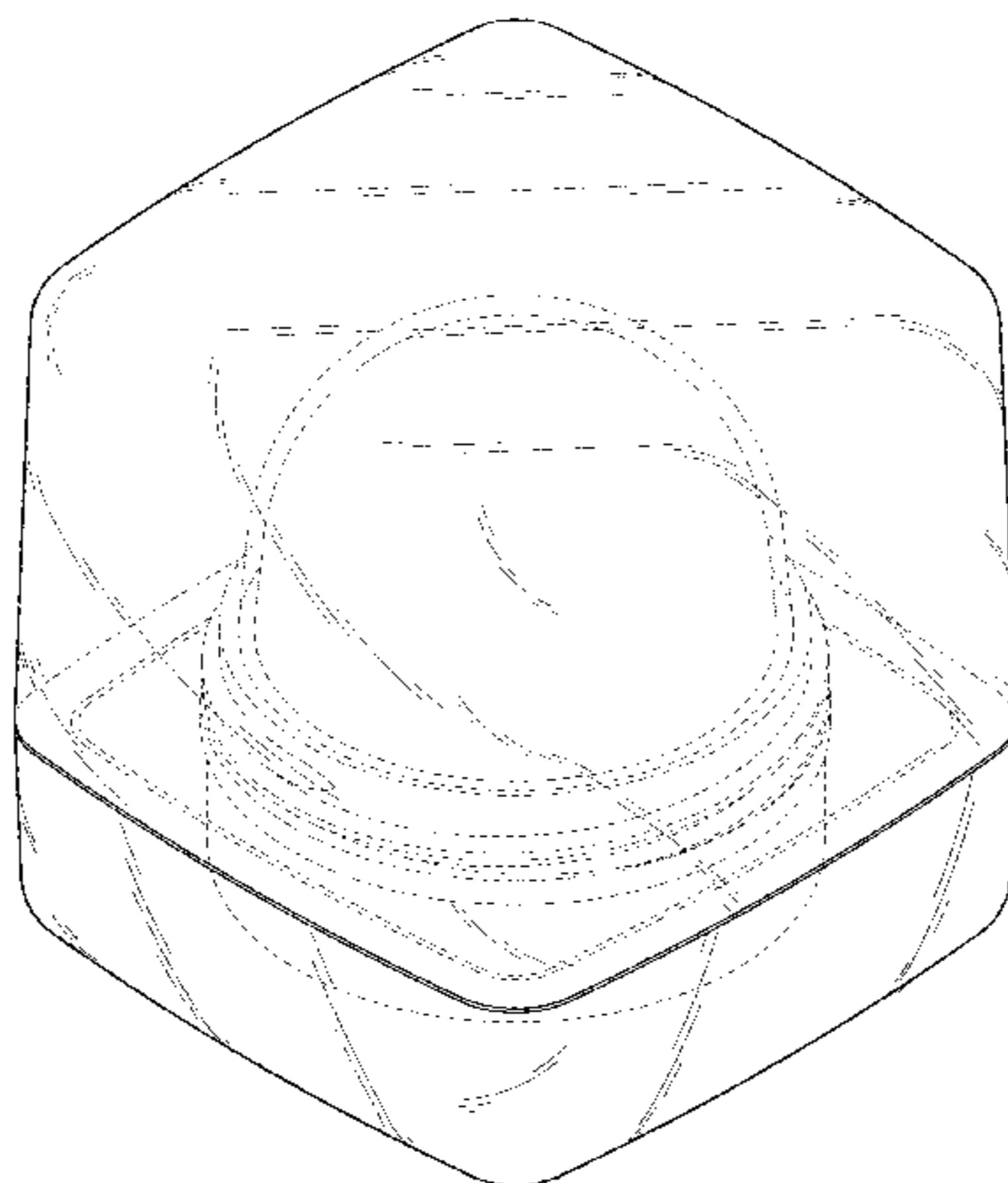

6,193,427 B1 2/2001 Benguigui
 6,293,721 B1 9/2001 Bow et al.
 D451,242 S * 11/2001 Neergaard D28/8.1
 6,367,640 B1 4/2002 Julian
 D467,038 S 12/2002 Restrepo
 D468,869 S * 1/2003 Thorpe et al. D28/85
 D477,227 S 7/2003 Goswell
 D478,513 S * 8/2003 Canamasas Puigbo D9/529
 D479,128 S 9/2003 Jowett
 D484,646 S * 12/2003 Ditrichstein D28/83
 D484,797 S * 1/2004 Kipperman et al. D9/424
 6,695,508 B2 * 2/2004 Gueret 401/9
 6,722,064 B2 4/2004 Knapp et al.
 D498,502 S * 11/2004 Duke D20/10
 6,820,744 B2 11/2004 Hoffman
 6,843,611 B2 1/2005 Blondeel et al.
 D505,517 S * 5/2005 Baresi et al. D28/76
 D506,867 S 7/2005 Galan
 D507,177 S 7/2005 Weissman
 6,923,347 B2 8/2005 Winckels
 D510,700 S 10/2005 Au
 6,988,630 B2 1/2006 Matsumoto
 D518,857 S * 4/2006 Miller D20/29
 7,025,520 B2 4/2006 Petit
 7,047,983 B2 5/2006 Manougian et al.
 D532,937 S * 11/2006 Noh D28/76
 D537,201 S * 2/2007 McLeish et al. D28/8.1
 D540,689 S * 4/2007 Dorfmueller D9/560
 D543,453 S * 5/2007 Fu et al. D3/302
 D552,633 S 10/2007 Volkan
 D555,835 S * 11/2007 Song D28/76
 D558,486 S * 1/2008 Hoang et al. D6/470
 D562,699 S * 2/2008 Green et al. D9/726
 D567,667 S * 4/2008 Kikuchi D9/687
 D582,291 S 12/2008 de Baschmakoff
 D584,950 S 1/2009 Courtaigne
 D592,502 S 5/2009 Casebasse
 D595,577 S * 7/2009 Uneno D9/504
 D604,605 S * 11/2009 Chung et al. D9/432
 7,614,405 B2 11/2009 Allen et al.
 D608,840 S * 1/2010 Crutchfield et al. D21/373
 D610,458 S * 2/2010 Martin D9/500
 D615,868 S 5/2010 Rodriguez et al.
 D620,368 S * 7/2010 Pedersen D9/529
 D625,469 S 10/2010 Dubitsky et al.
 D630,514 S * 1/2011 Niikura et al. D9/504
 D631,204 S 1/2011 Dubitsky et al.
 D639,702 S * 6/2011 Jean-Denis D11/131
 D644,108 S * 8/2011 Vila Calvo D9/529
 D644,939 S 9/2011 Teller
 D649,449 S * 11/2011 Akana et al. D9/430
 D651,903 S 1/2012 Teller
 D656,598 S * 3/2012 Motylinski et al. D23/366
 8,162,140 B2 * 4/2012 Hansen et al. 206/438
 D659,530 S 5/2012 Akana et al.
 D663,524 S * 7/2012 Penttinen D3/273
 8,210,347 B2 7/2012 McLaughlin
 8,226,311 B2 7/2012 Cronin
 D668,143 S * 10/2012 Akana et al. D9/424
 D672,554 S * 12/2012 Penttinen D3/273
 D677,173 S 3/2013 D'Hollander
 D686,065 S 7/2013 Kuo et al.
 D699,129 S * 2/2014 Possell et al. D9/734
 D702,547 S * 4/2014 Akana et al. D9/424
 D706,643 S * 6/2014 Akana et al. D9/721
 D709,385 S * 7/2014 Vural D9/721
 D709,652 S 7/2014 Teller
 D711,236 S 8/2014 Friesen et al.
 D713,286 S * 9/2014 Malaspina D11/157
 D723,766 S * 3/2015 Kamakura et al. D1/127
 D726,028 S 4/2015 Thompson
 D732,240 S 6/2015 Brown
 D734,550 S 7/2015 Schlatter
 D734,895 S 7/2015 Liu
 D735,413 S 7/2015 Smith et al.
 D735,415 S 7/2015 Thompson
 2002/0038661 A1 * 4/2002 Gueret 132/320
 2002/0127046 A1 9/2002 Gueret
 2004/0069677 A1 4/2004 Baudin

2004/0074805 A1 4/2004 Petit
 2004/0237996 A1 12/2004 Fischer et al.
 2005/0002724 A1 1/2005 Blondeel et al.
 2005/0011895 A1 * 1/2005 Lin 220/300
 2005/0082180 A1 4/2005 Smouha
 2005/0167307 A1 8/2005 Cheng
 2005/0218560 A1 10/2005 Booth
 2005/0257805 A1 11/2005 Williams
 2006/0005853 A1 1/2006 Shen
 2006/0186075 A1 8/2006 Rainey et al.
 2006/0201838 A1 9/2006 Sasaki
 2006/0254945 A1 11/2006 Green et al.
 2006/0272671 A1 12/2006 Dobler et al.
 2007/0017915 A1 1/2007 Weder et al.
 2007/0204876 A1 9/2007 Allen et al.
 2007/0295619 A1 12/2007 Lee
 2009/0022541 A1 1/2009 De Laforcade
 2009/0032424 A1 2/2009 McLaughlin
 2010/0175704 A1 7/2010 Gueret
 2010/0322693 A1 12/2010 Mallardi, III
 2011/0024316 A1 2/2011 Ginsburg
 2011/0135377 A1 6/2011 Teller
 2013/0302080 A1 11/2013 Teller
 2013/0308993 A1 11/2013 Teller
 2013/0322950 A1 12/2013 Teller
 2013/0341832 A1 12/2013 Teller
 2013/0341833 A1 12/2013 Teller
 2014/0013712 A1 1/2014 Teller
 2015/0096919 A1 4/2015 Thompson

FOREIGN PATENT DOCUMENTS

CL	2008-00214	7/2009
CL	2008-01867	7/2009
CL	2009-01526	8/2010
CL	2012-00483	10/2012
CL	201301766	2/2014
EM	001149918-0001	2/2009
EM	001598350-0001	5/2009
GB	3007936	10/2002
GB	3009382	12/2002
JP	D1488404	12/2013
JP	D1488405	12/2013
KR	30-0588936	11/2010
KR	30-0608676	8/2011
PH	3-2001-000516	4/2003
PH	3-2007-000071	5/2007
PH	3-2010-000473	8/2010
PH	3-2011-000307	10/2011
TW	D113013	9/2006
TW	D144113	12/2011

OTHER PUBLICATIONS

Photographs of "Mentholatum Water Lip Massage Therapy" product and cosmetic container on sale in Vietnam since 2007.
 Photographs of "Water Replenish" cosmetic container on sale in China from 2005 to 2011.
 Amazon.com. "Cube Cosmetic Container 50g/6 pcs" First available on amazon.com on Jul. 2, 2014. (http://www.amazon.com/gp/product/BOOLGI57LW?ref_=pd_ybh_2). Accessed by US PTO on Aug. 12, 2015.
 Google image search. "capsule toy", date restricted to show results prior to May 8, 2013. Accessed by US PTO on Aug. 13, 2015.
 Google image search. "clear lip pot", date restricted to show results prior to May 8, 2013. Accessed by US PTO on Aug. 13, 2015.
 Makeup Morsels Biog. "A Tale of Two Eyedrops". Posted on Oct. 16, 2010. Accessed by US PTO on Aug. 13, 2015. (<https://makeupmorsels.wordpress.com/2010/10/16/a-tale-of-two-eyedrops/>).

* cited by examiner

Primary Examiner — Marianne Pandozzi

Assistant Examiner — Jae Liang

(74) *Attorney, Agent, or Firm* — Pearne & Gordon LLP

(57)

CLAIM

The ornamental design for a cosmetic container, as shown and described.

DESCRIPTION

FIG. 1 is a perspective view of a first embodiment of a cosmetic container showing our new design;

FIG. 2 is a left side view thereof;

FIG. 3 is a right side view thereof;

FIG. 4 is a front view thereof;

FIG. 5 is a rear view thereof;

FIG. 6 is a top view thereof; and,

FIG. 7 is a bottom view thereof.

FIG. 8 is a perspective view of a second embodiment of a cosmetic container;

FIG. 9 is a left side view thereof;

FIG. 10 is a right side view thereof;

FIG. 11 is a front view thereof;

FIG. 12 is a rear view thereof;

FIG. 13 is a top view thereof; and,

FIG. 14 is a bottom view thereof.

FIG. 15 is a perspective view of a third embodiment of a cosmetic container;

FIG. 16 is a left side view thereof;

FIG. 17 is a right side view thereof;

FIG. 18 is a front view thereof;

FIG. 19 is a rear view thereof;

FIG. 20 is a top view thereof; and,

FIG. 21 is a bottom view thereof.

The broken line showing in the figure drawings are included for the purpose of illustration and form no part of the claimed design.

1 Claim, 12 Drawing Sheets

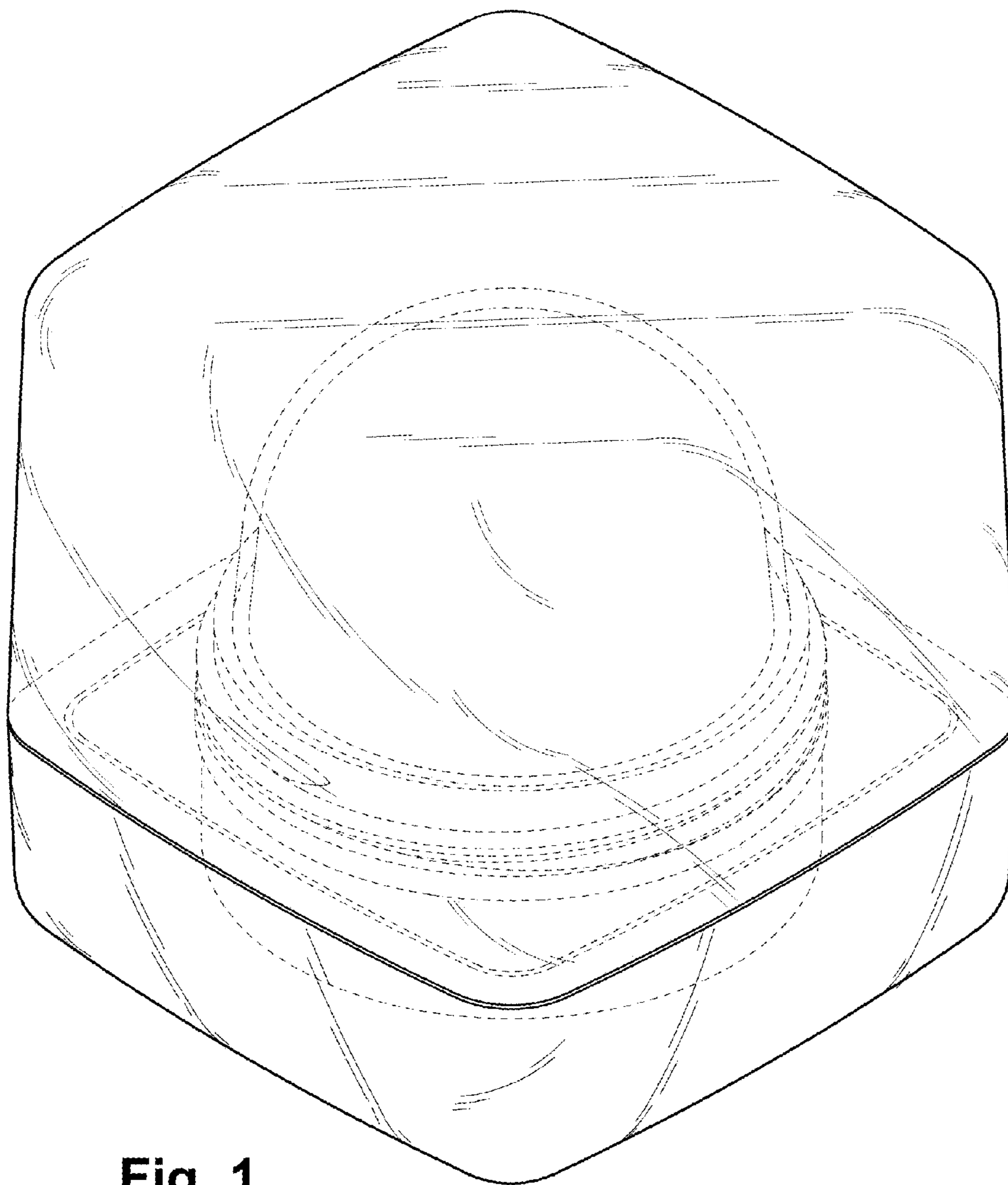

Fig. 1

Fig. 2

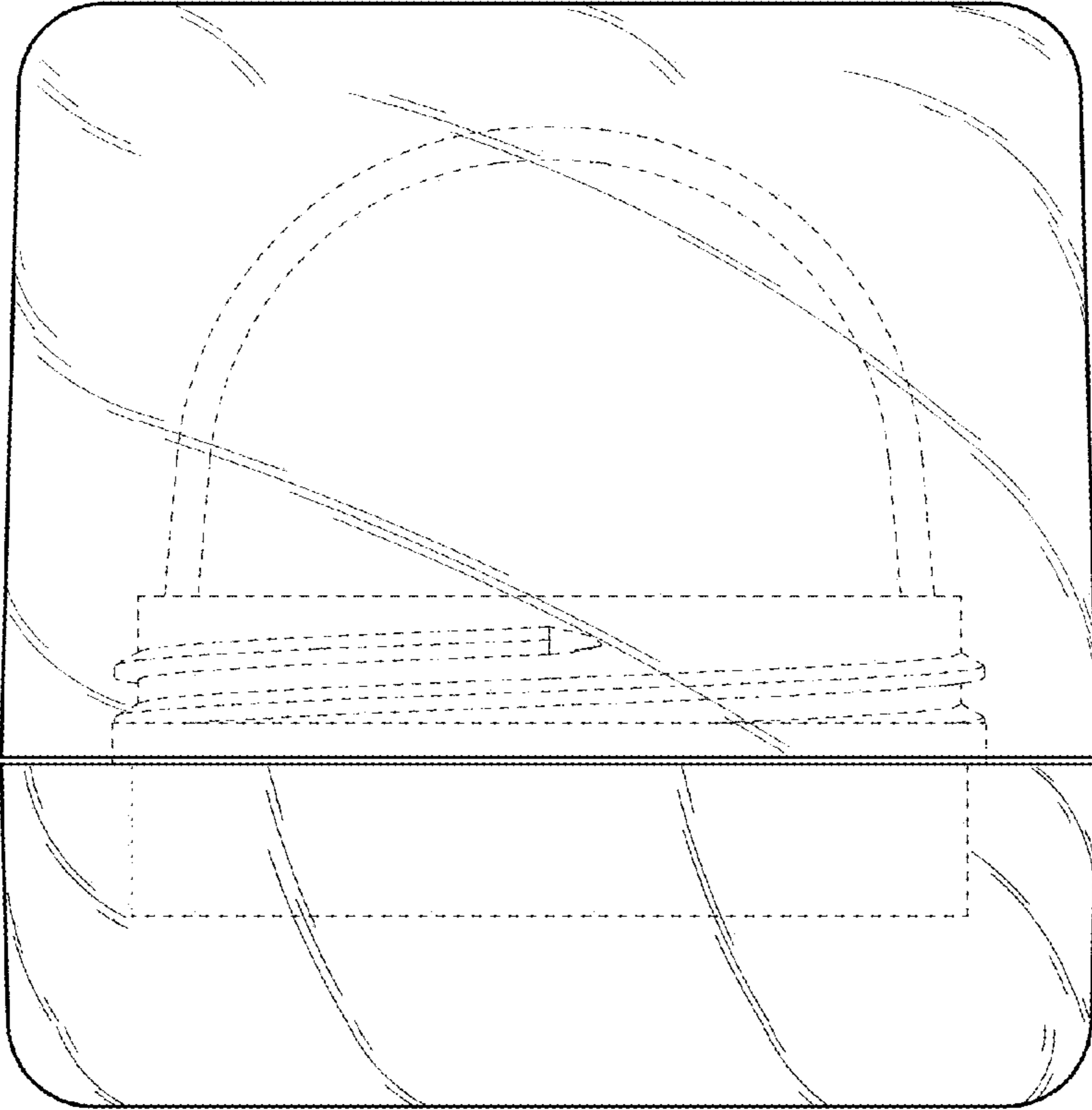

Fig. 3

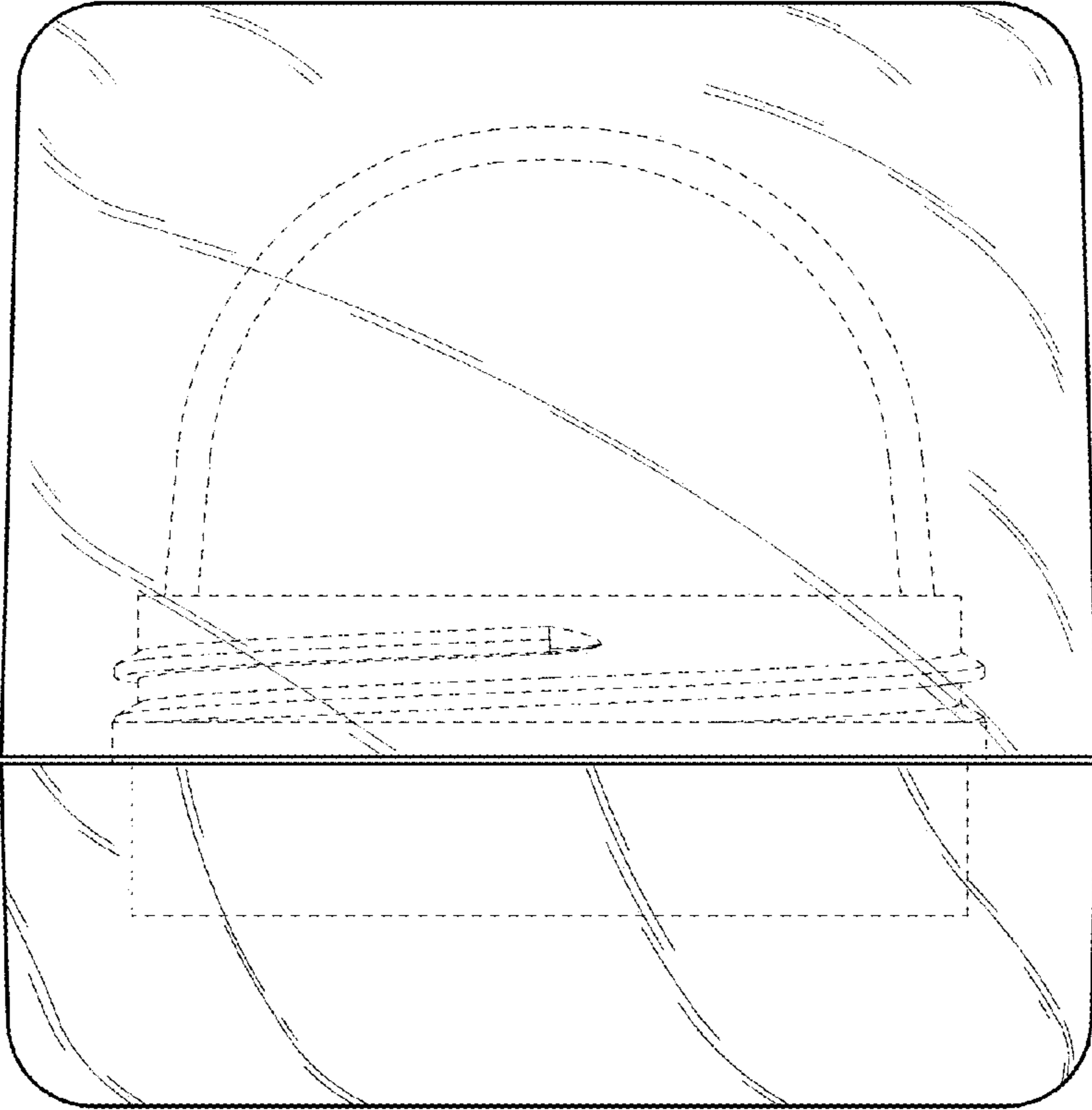

Fig. 4

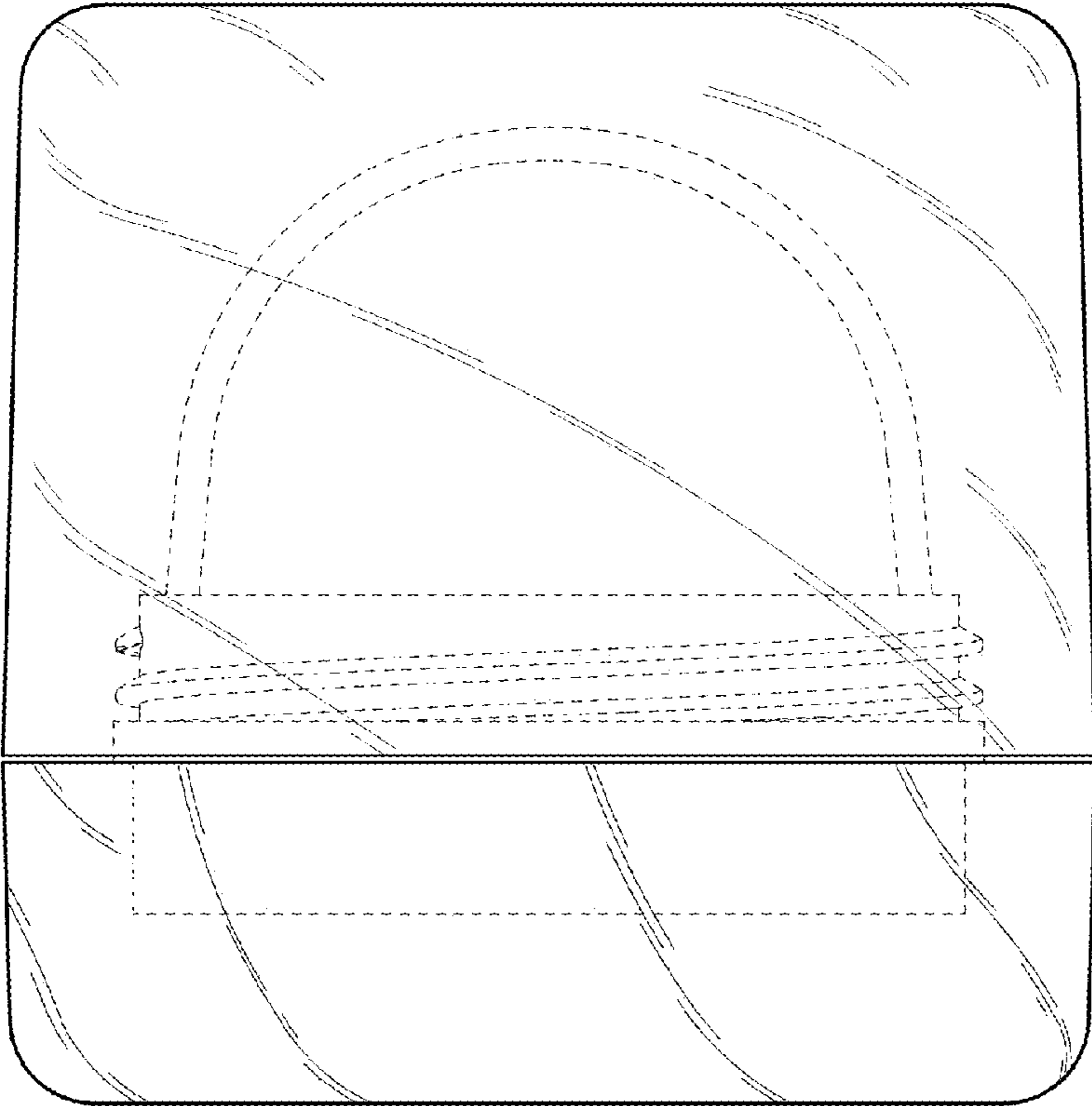

Fig. 5

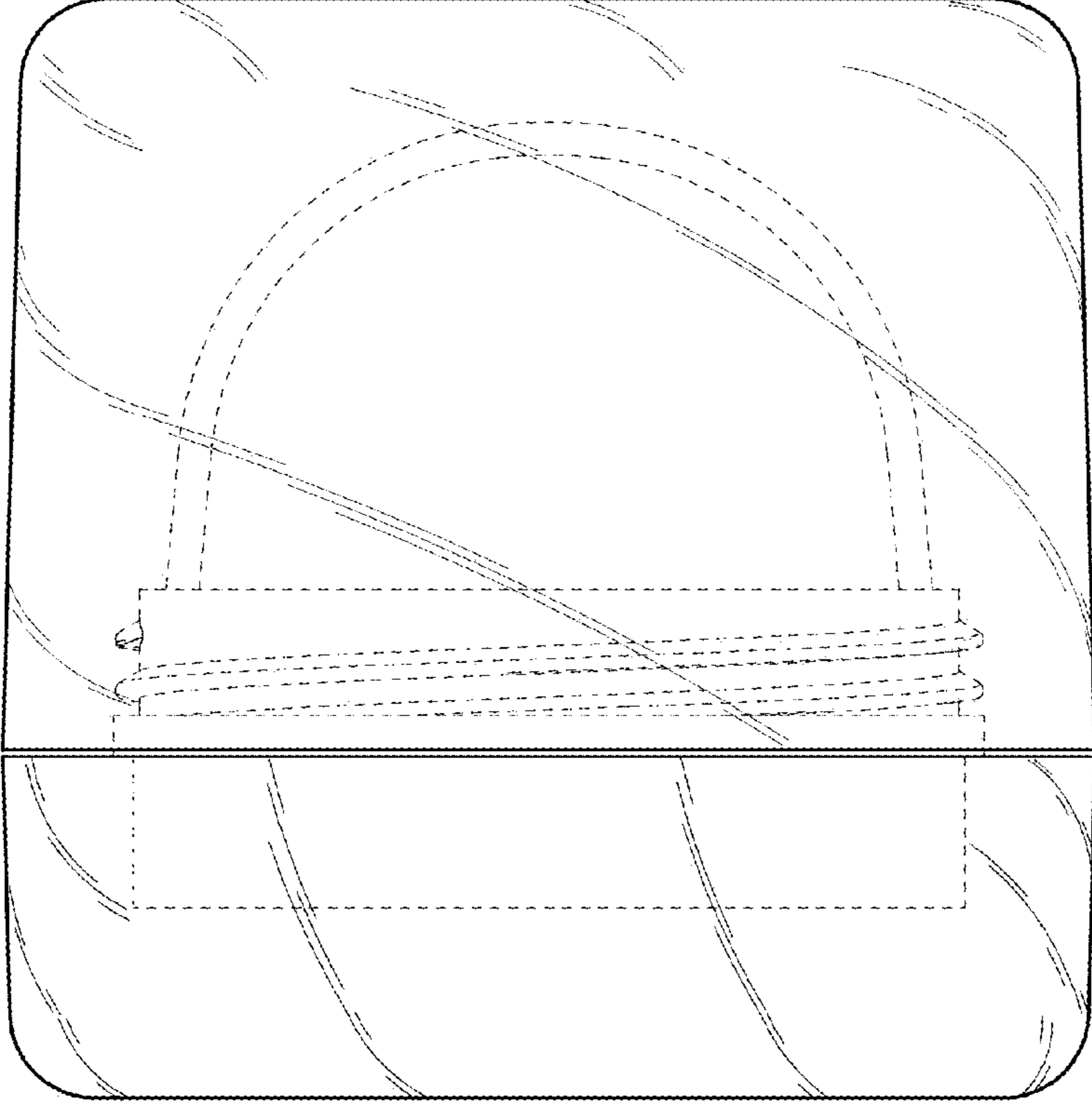

Fig. 6

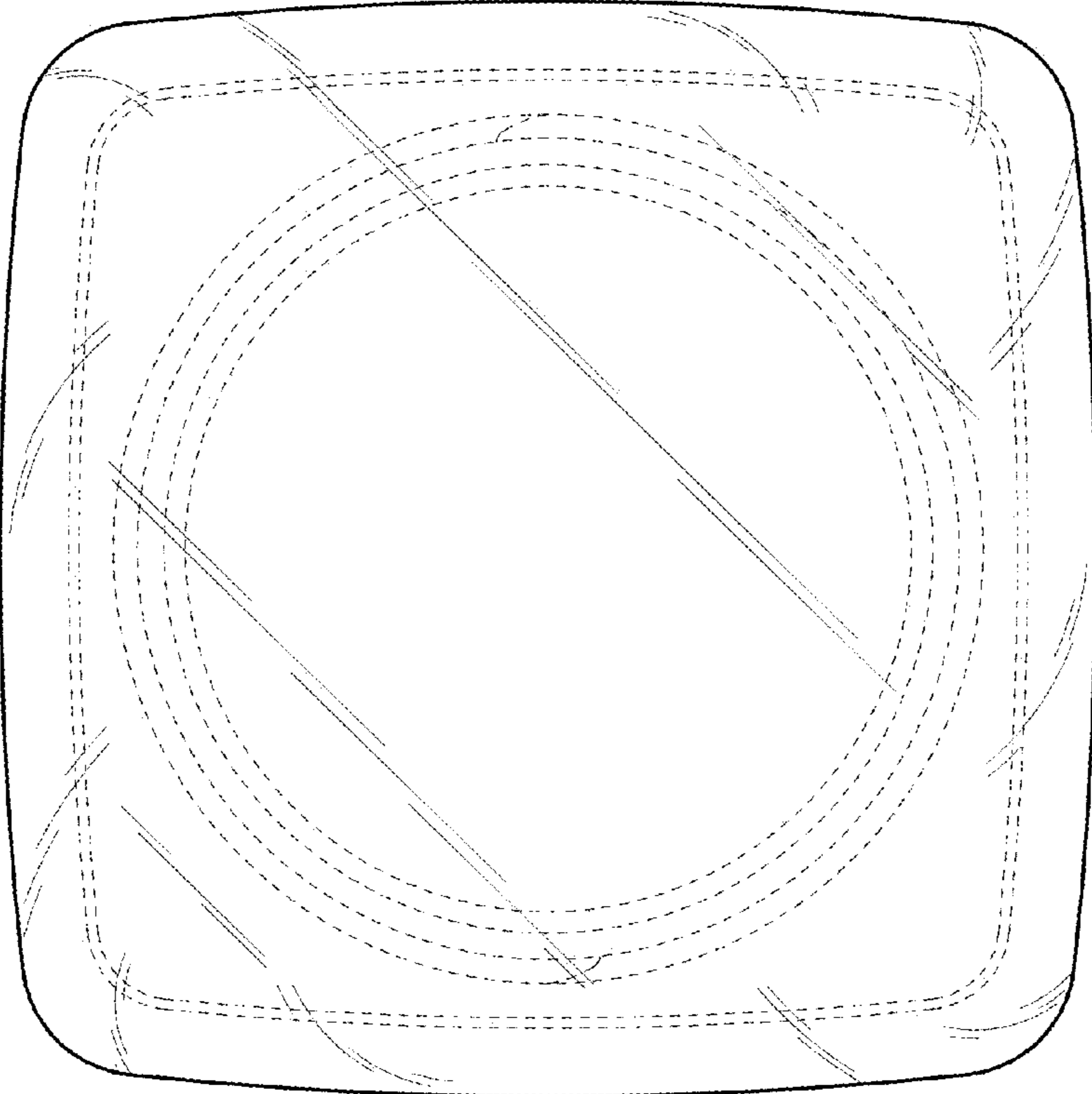
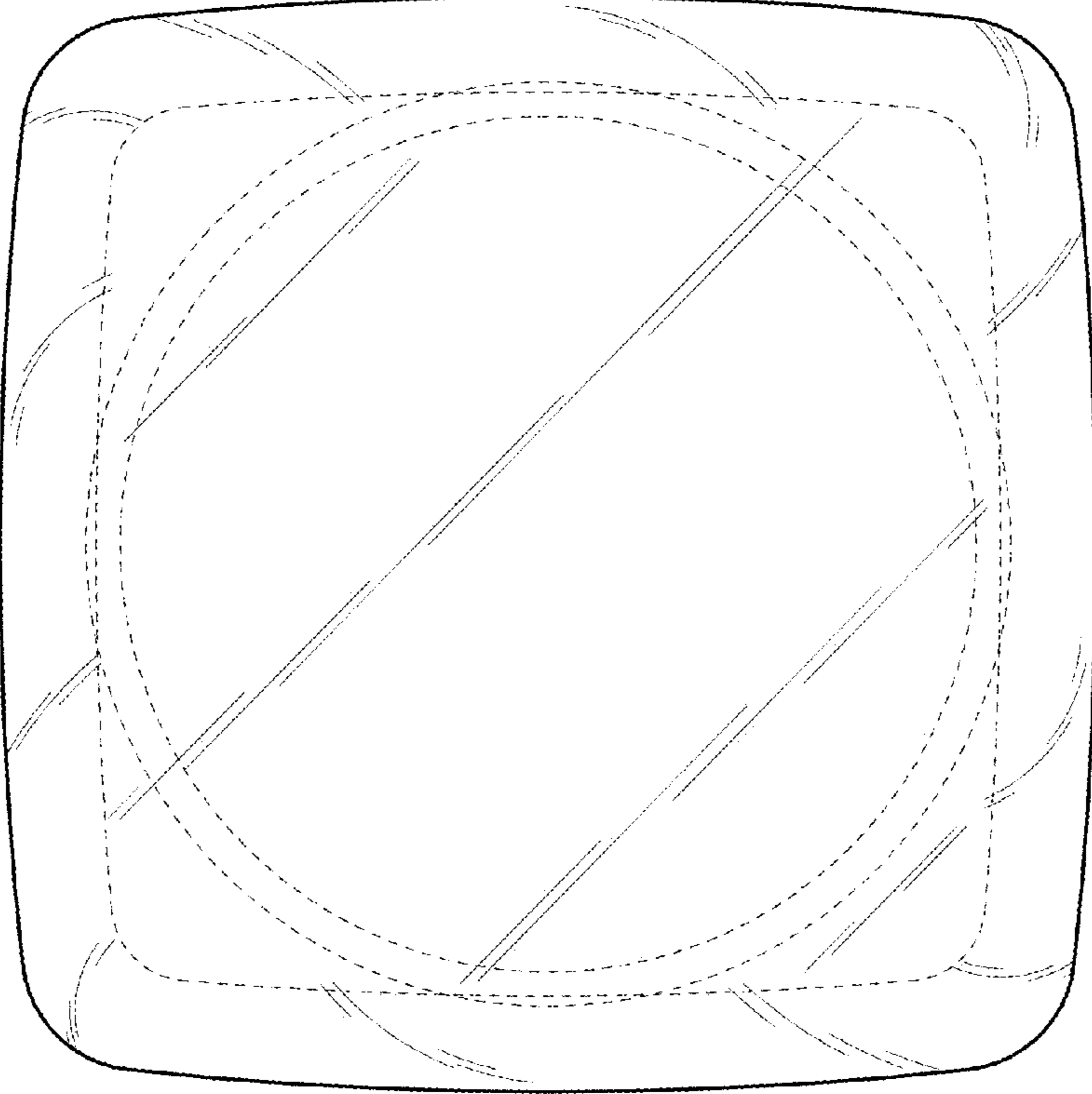

Fig. 7



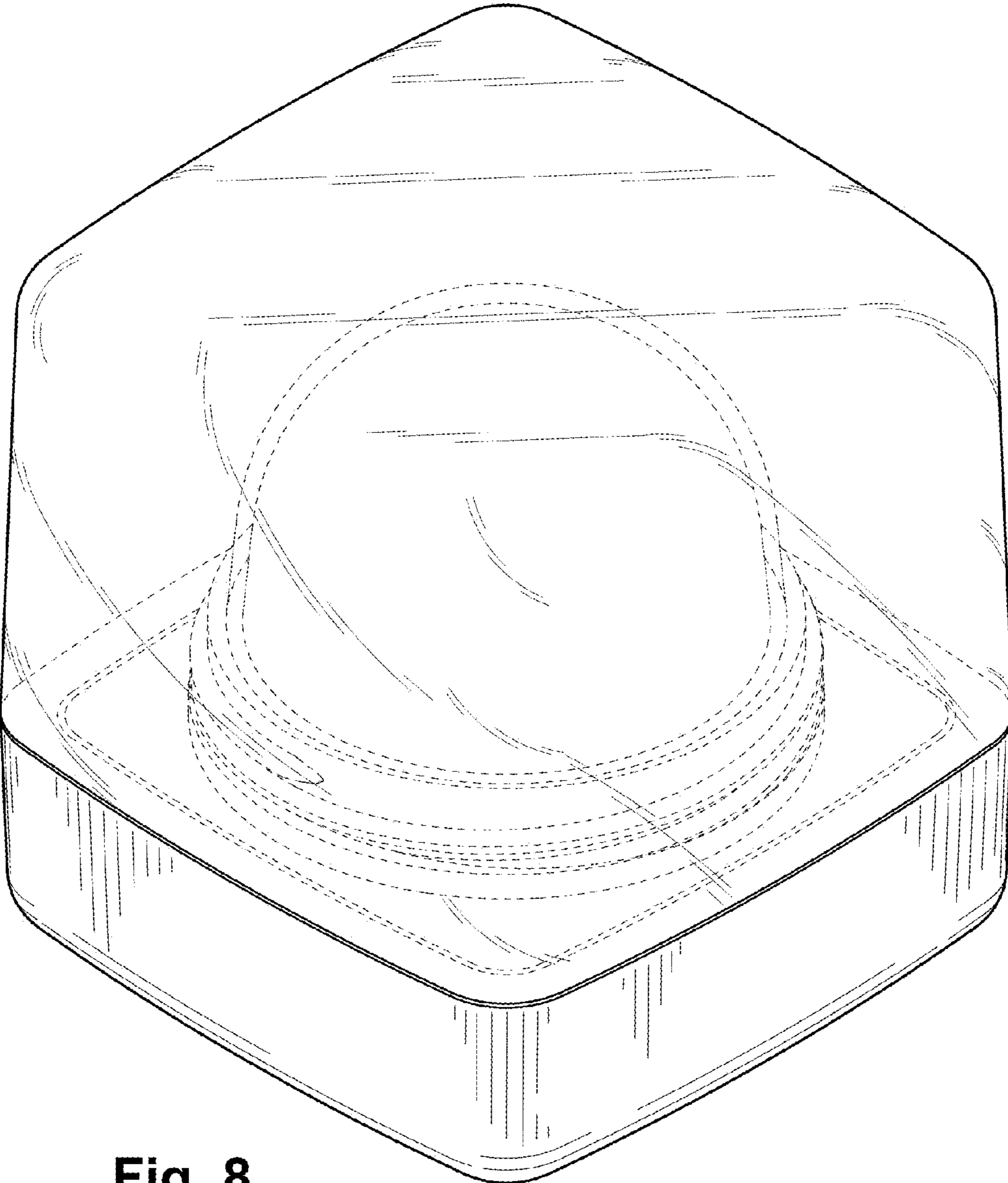

Fig. 8

Fig. 9

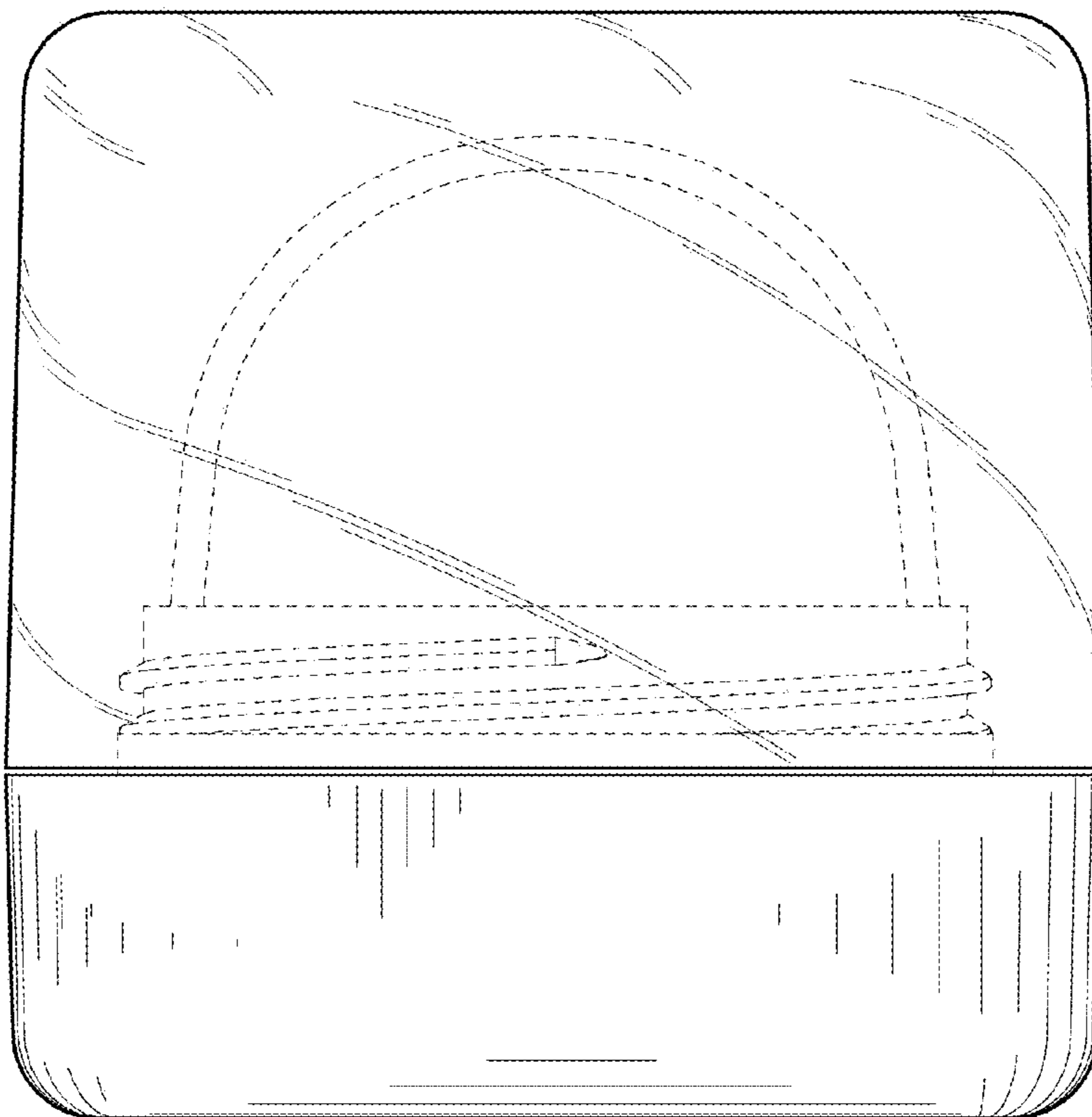

Fig. 10

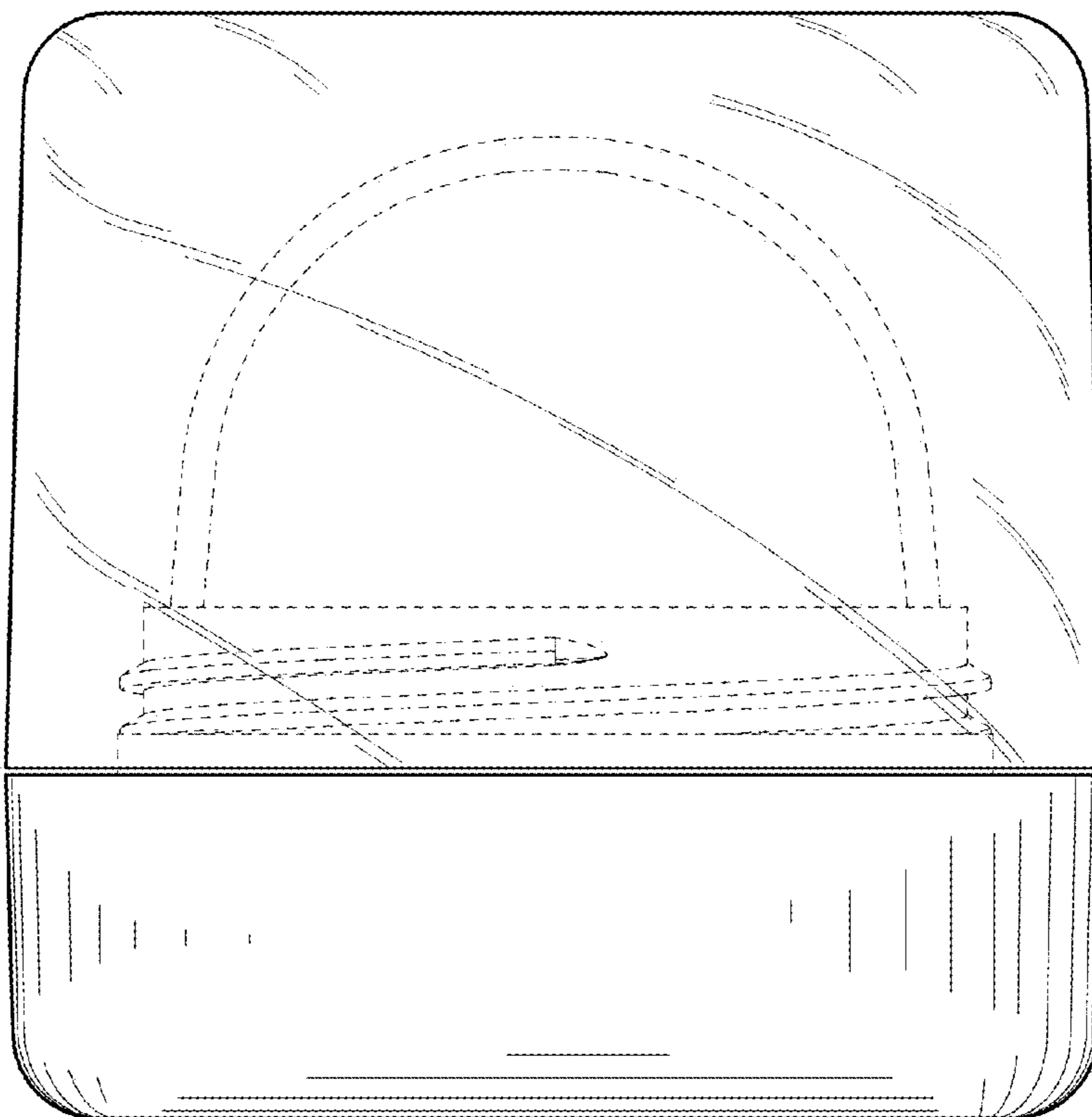

Fig. 11

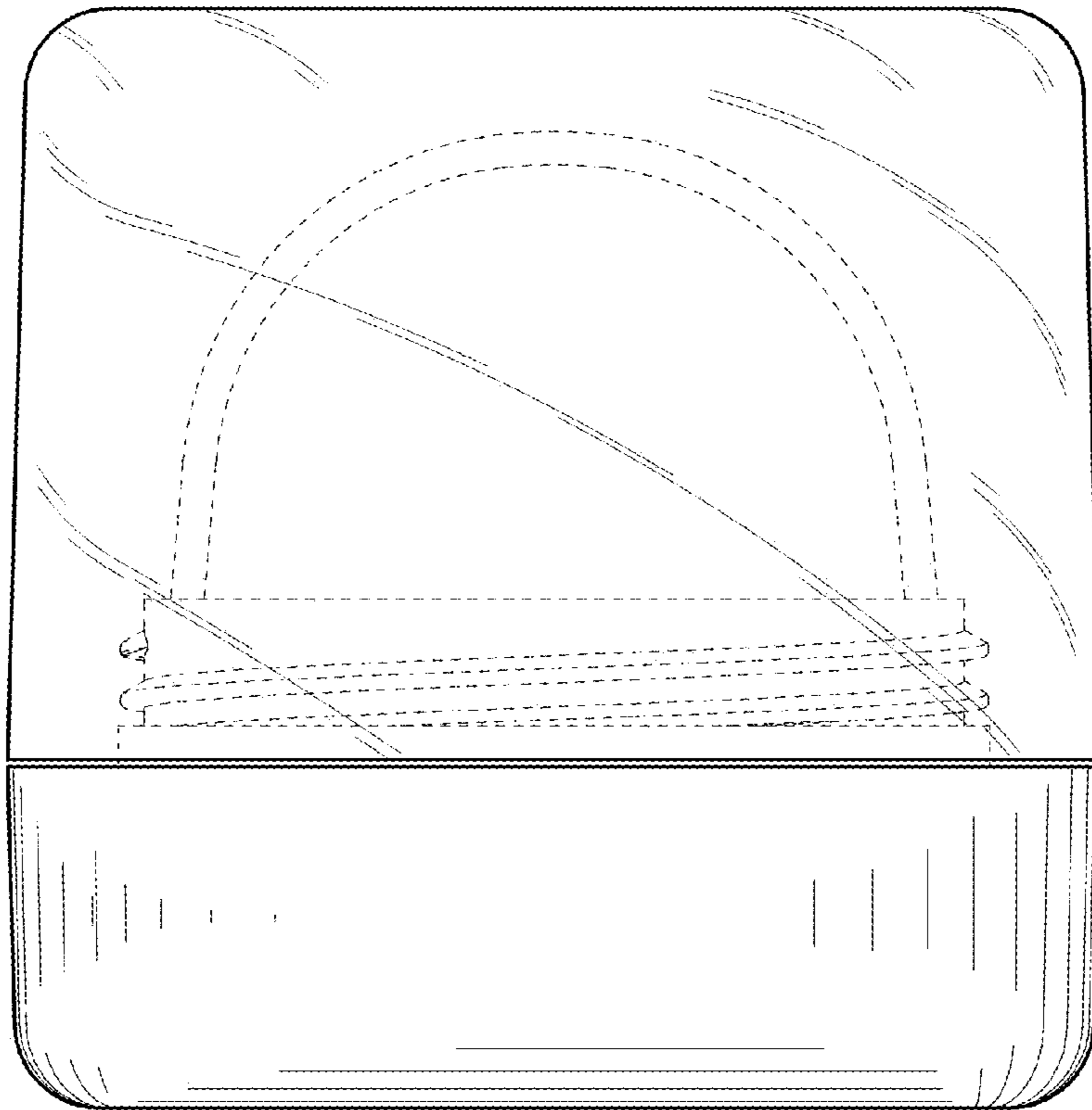

Fig. 12

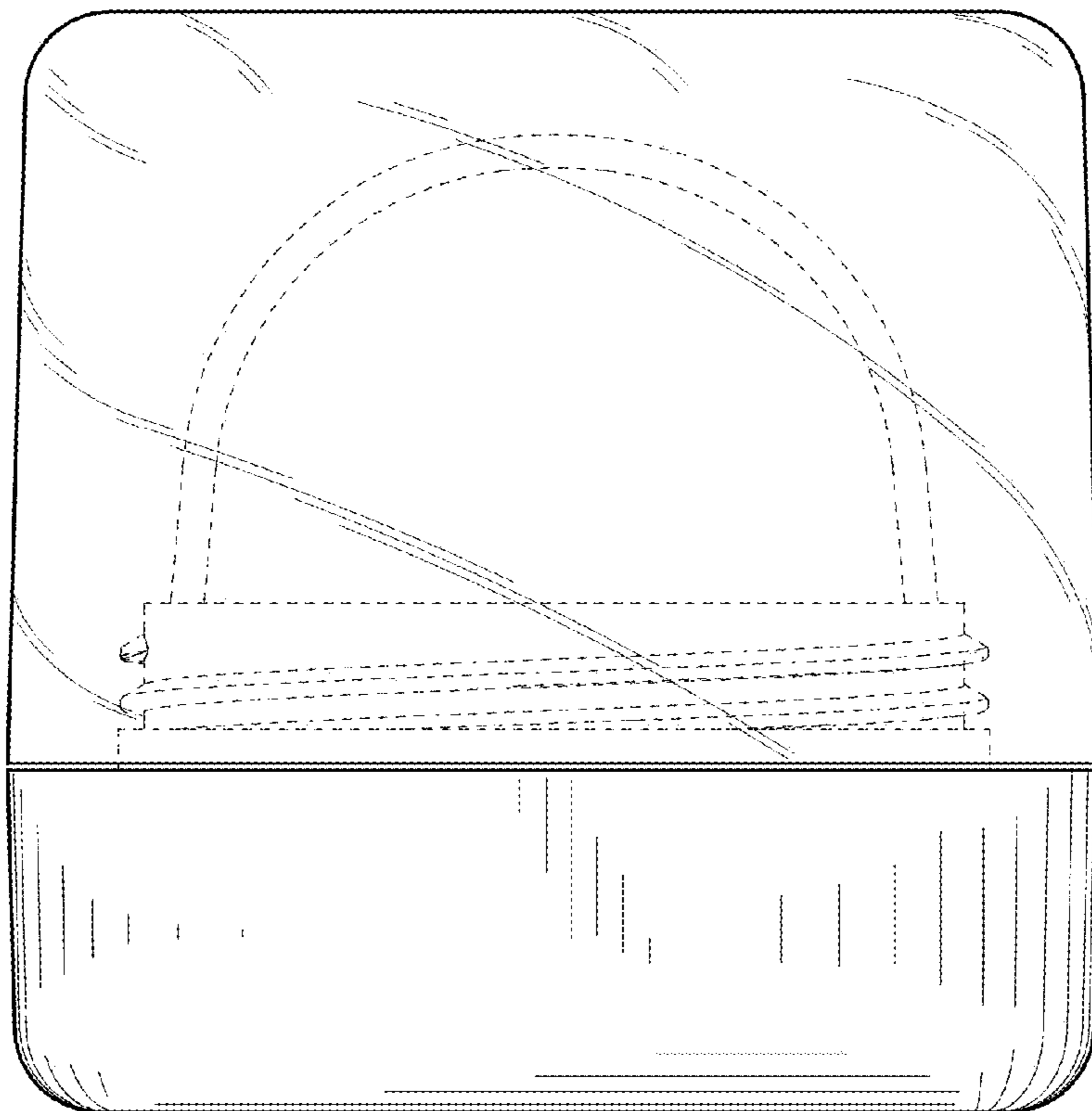

Fig. 13

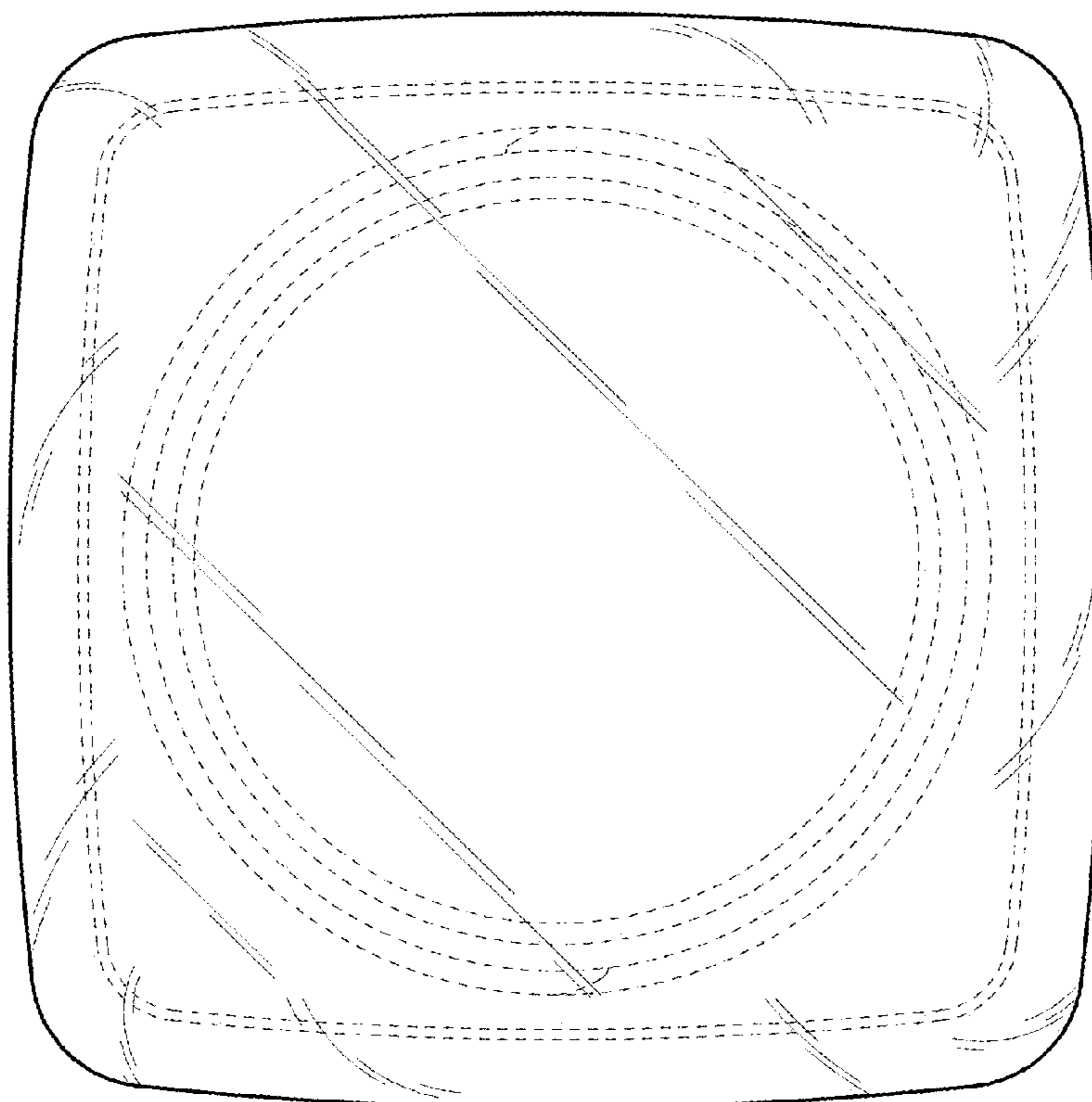
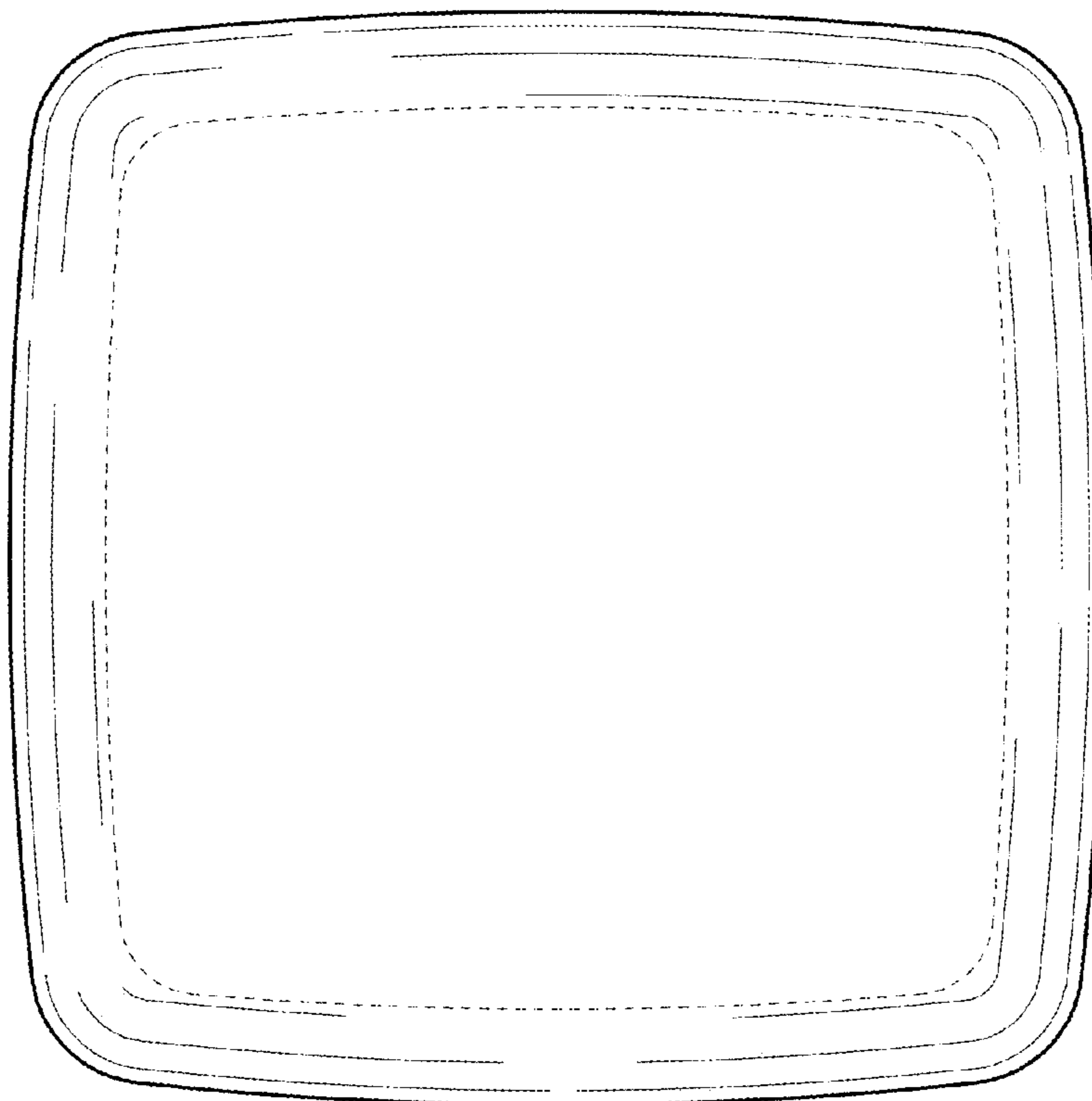

Fig. 14



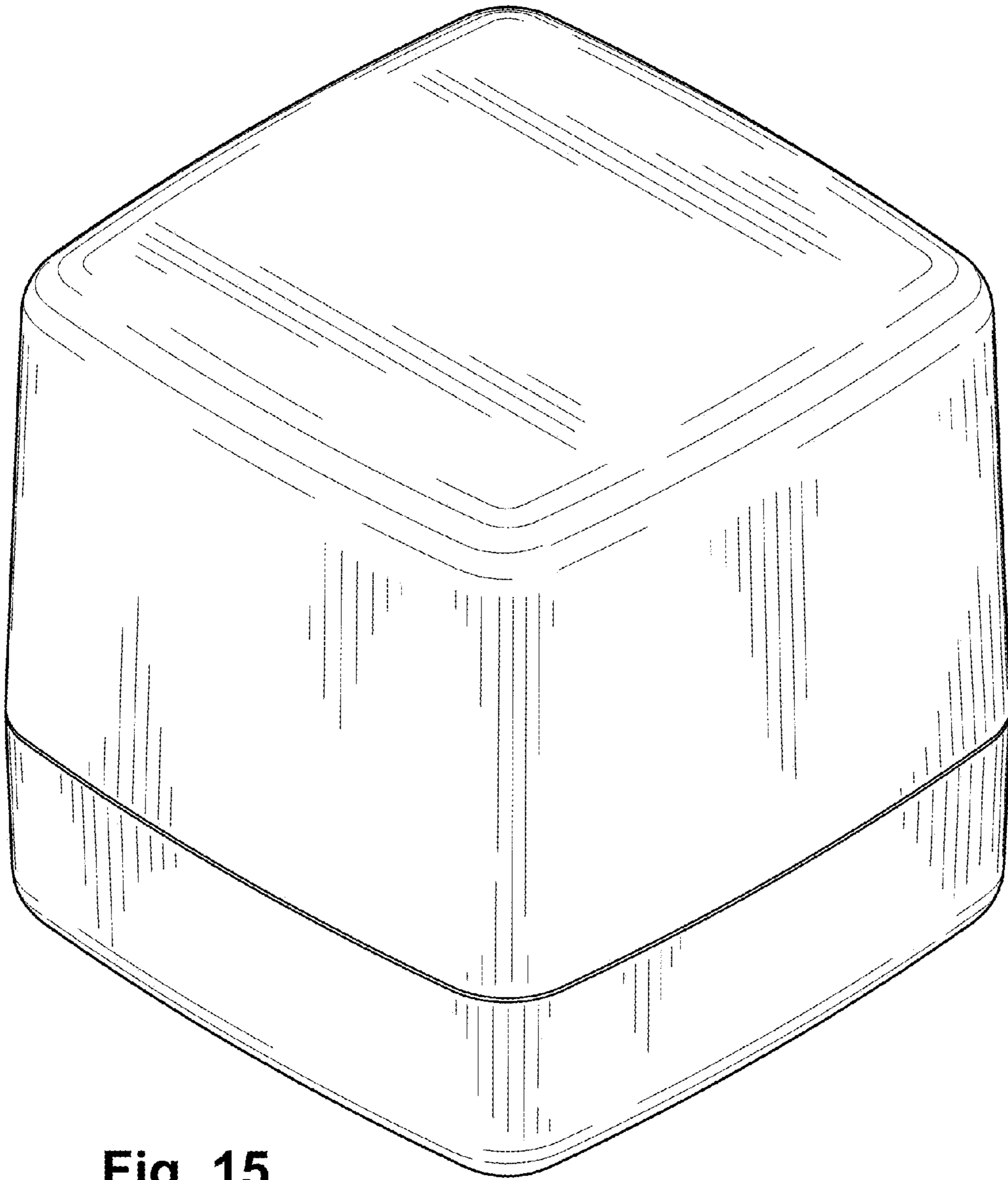

Fig. 15

Fig. 16

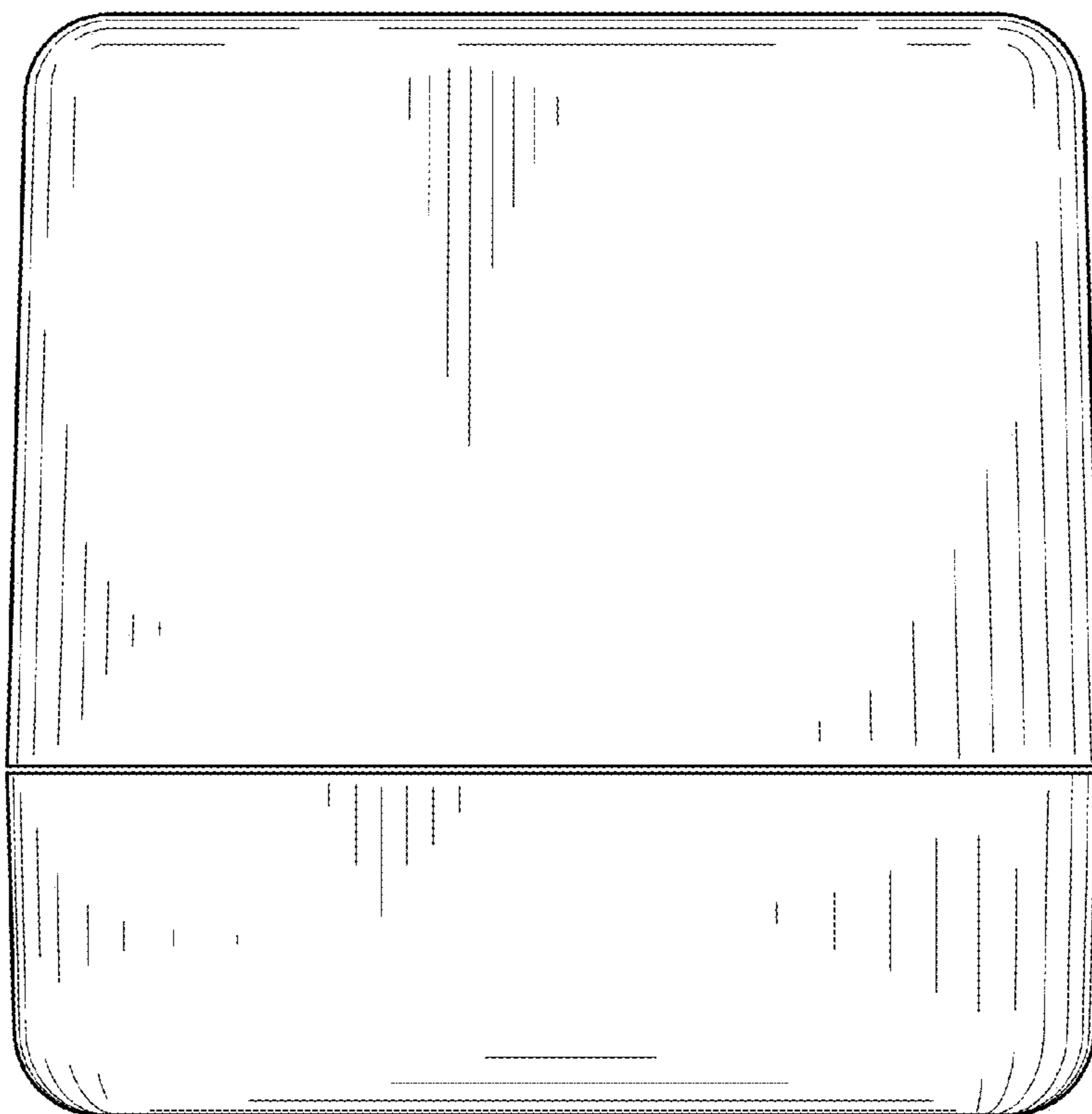

Fig. 17

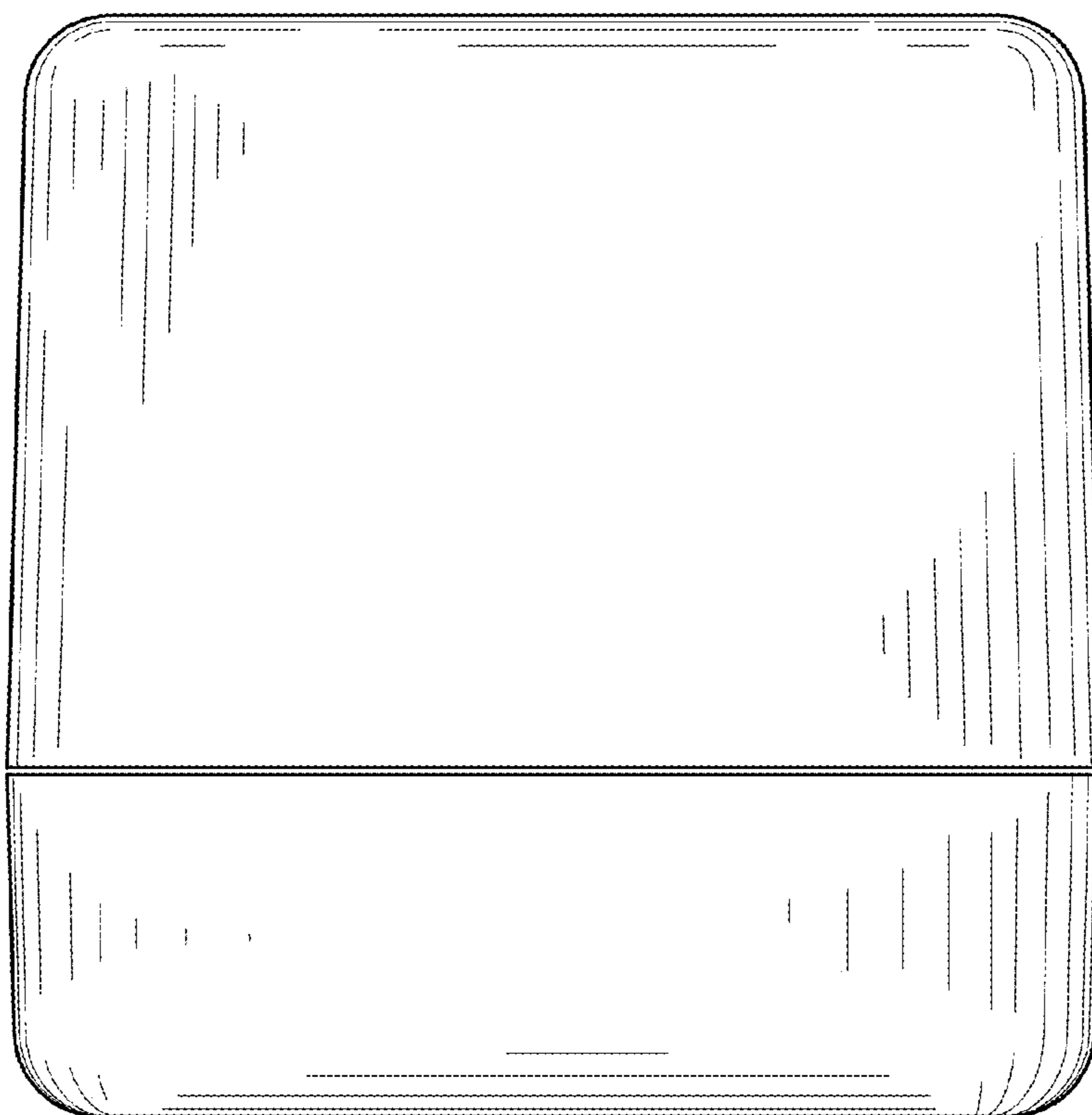

Fig. 18

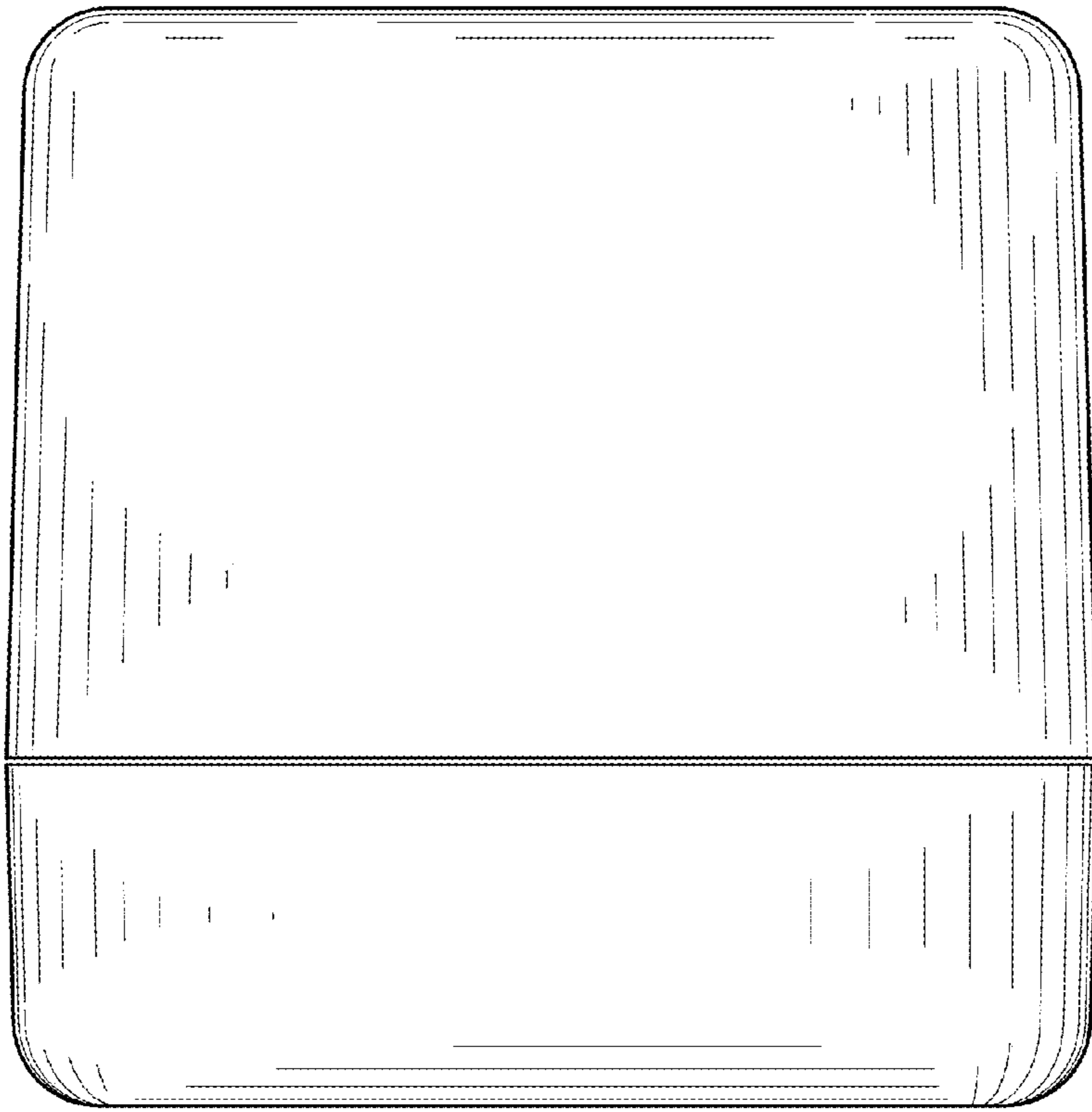

Fig. 19

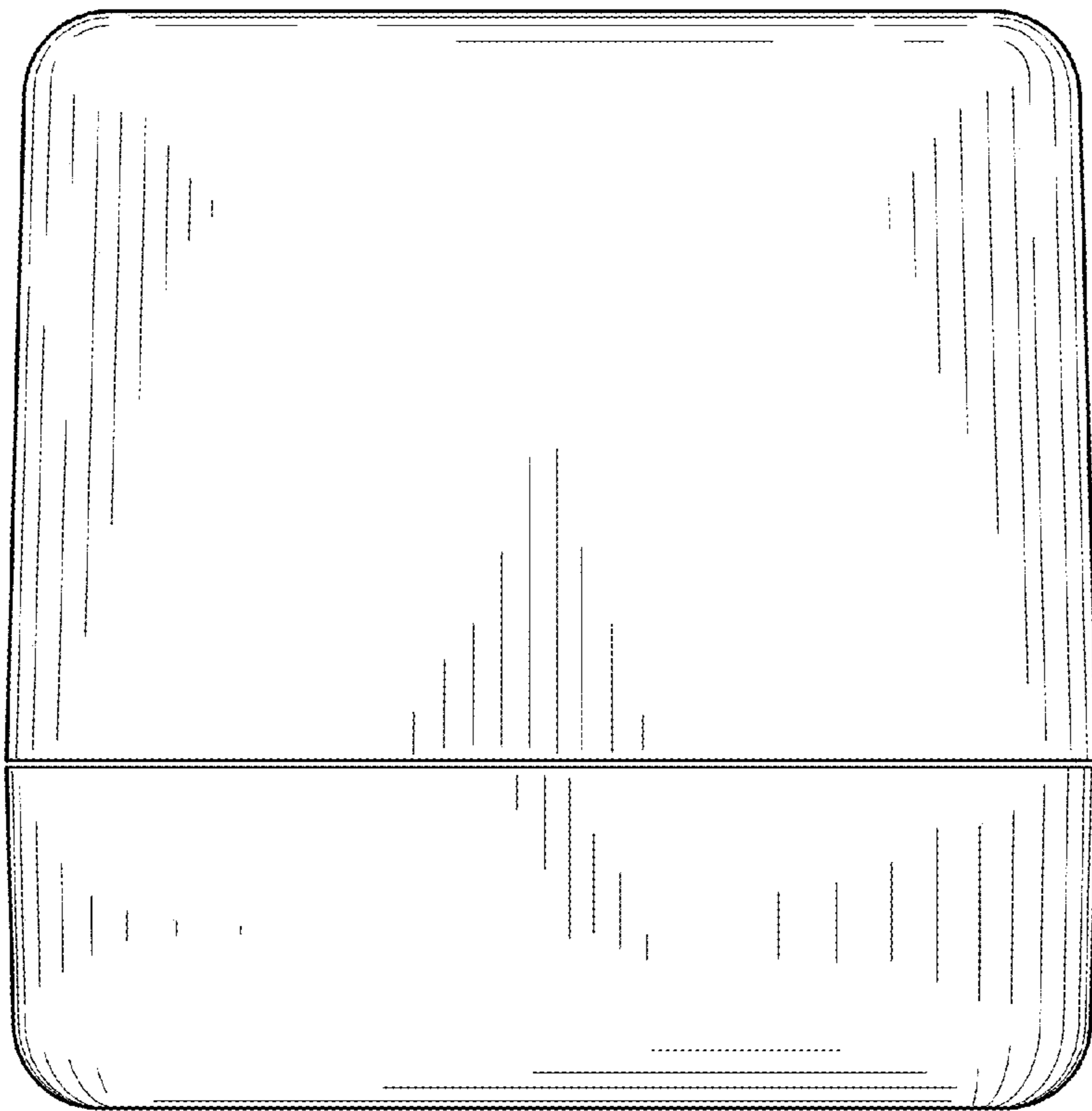

Fig. 20

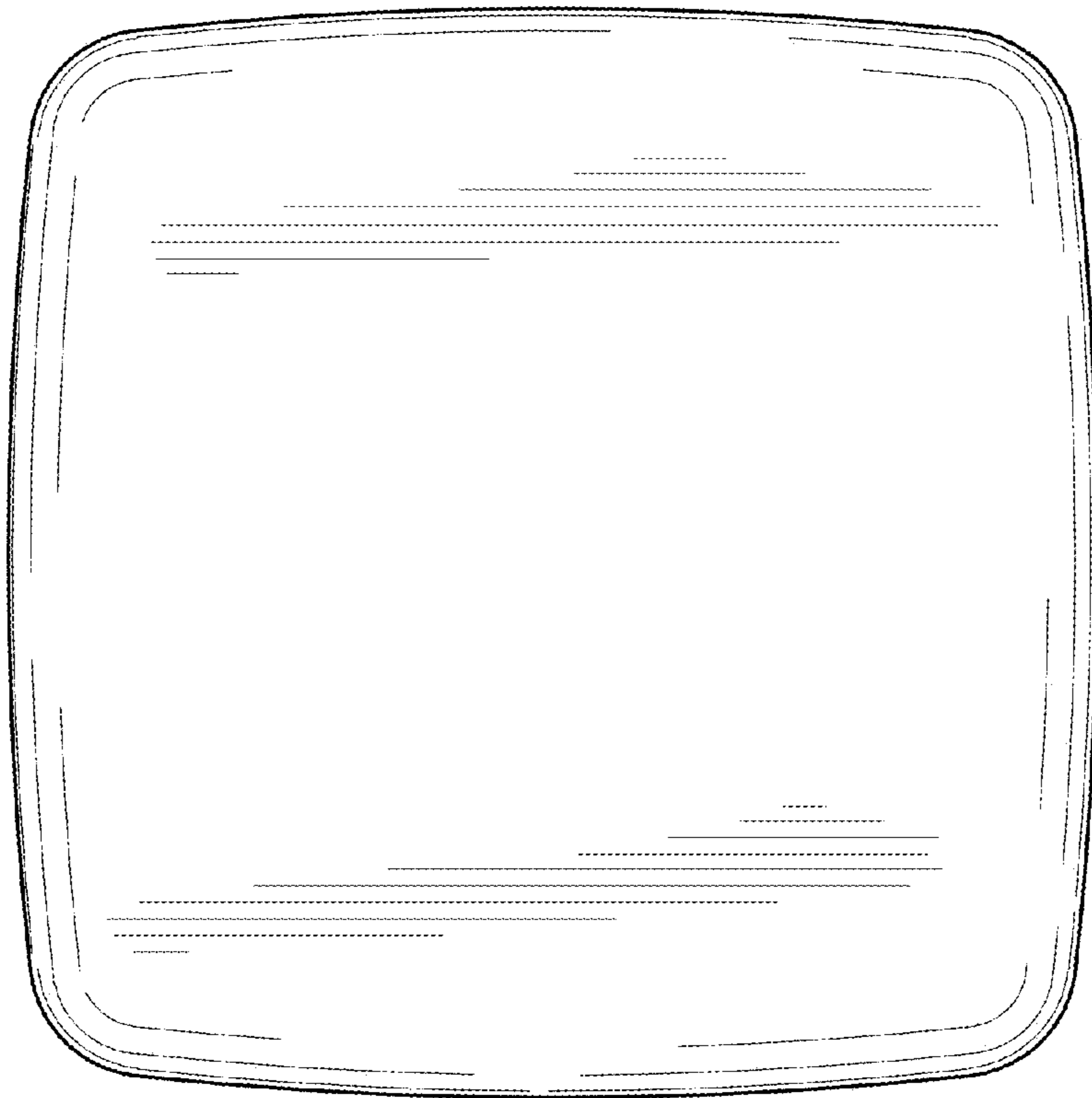

Fig. 21

