



US00D742575S

(12) **United States Design Patent**
Blum et al.

(10) **Patent No.:** **US D742,575 S**
(45) **Date of Patent:** **** Nov. 3, 2015**

(54) **LUMINAIRE**

(71) Applicant: **ABL IP Holding, LLC**, Conyers, GA
(US)

(72) Inventors: **Darren Blum**, San Mateo, CA (US);
Michael Trung Tran, Oakland, CA
(US); **Peter Y. Y. Ngai**, Alamo, CA (US)

(73) Assignee: **ABL IP Holding, LLC**, Conyers, GA
(US)

(**) Term: **14 Years**

(21) Appl. No.: **29/525,768**

(22) Filed: **May 1, 2015**

(51) **LOC (10) Cl.** **26-03**

(52) **U.S. Cl.**
USPC **D26/85**

(58) **Field of Classification Search**
USPC D26/72, 85, 87, 89, 92, 118, 120
CPC F21S 8/03; F21S 8/033; F21S 8/036;
F21S 8/037; F21S 8/043; F21S 8/06; F21V
21/02; F21V 33/006; F21W 2131/10; F21W
2131/107; F21W 2131/1005
See application file for complete search history.

(56) **References Cited**

U.S. PATENT DOCUMENTS

D31,764 S *	10/1899	Locke	D25/103
D127,397 S *	5/1941	Johnston	362/223
D165,738 S *	1/1952	Brochstein	D26/85
D454,971 S *	3/2002	Crosby	D26/85
D584,848 S *	1/2009	Menke	D26/76
D608,935 S *	1/2010	Pedersen	D26/85
D626,275 S *	10/2010	Sabernig	D26/85
8,038,315 B1 *	10/2011	Santoro	F21S 8/061 362/217.05
D664,282 S *	7/2012	Santoro	D26/76
D676,997 S *	2/2013	Tang	D26/87
8,430,530 B2 *	4/2013	Aurongzeb	F21S 8/06 362/249.03
D683,066 S *	5/2013	Myung	D26/120
D685,945 S *	7/2013	Lindsley	D26/85

D700,989 S *	3/2014	Rampolla	D26/88
D703,864 S *	4/2014	Blum	D26/118
D713,589 S *	9/2014	Blum	D26/85
D713,591 S *	9/2014	Blum	D26/85
D724,250 S *	3/2015	Tran	D26/85
D730,560 S *	5/2015	Tran	D26/85
2014/0049956 A1 *	2/2014	Manahan	F21V 21/14 362/233
2015/0060779 A1 *	3/2015	Kawahara	F21S 8/033 257/40

* cited by examiner

Primary Examiner — Clare E Heflin

(74) *Attorney, Agent, or Firm* — Beeson Skinner Beverly, LLP

(57) **CLAIM**

The ornamental design for a luminaire, as shown and described.

DESCRIPTION

FIG. 1 is a top front perspective view of a luminaire showing our new design;

FIG. 2 is a bottom front perspective view thereof;

FIG. 3 is a front elevational view thereof;

FIG. 4 is right end elevational view thereof;

FIG. 5 is a left end elevational view thereof;

FIG. 6 is a top plan view thereof; and

FIG. 7 is a bottom plan view thereof.

FIG. 8 is a top front perspective view of a luminaire showing an alternative embodiment of our new design;

FIG. 9 is a bottom front perspective view thereof;

FIG. 10 is a front elevational view thereof;

FIG. 11 is right end elevational view thereof;

FIG. 12 is a left end elevational view thereof;

FIG. 13 is a top plan view thereof; and,

FIG. 14 is a bottom plan view thereof.

The back of the luminaire forms no part of the claimed design and is not shown.

In the embodiment shown in FIGS. 8-14, the broken line rectangles shown in FIGS. 8 and 13 represent area light sources such as OLED panels. The area light sources shown in broken lines form no part of the claimed design shown in FIGS. 8-14.

1 Claim, 6 Drawing Sheets

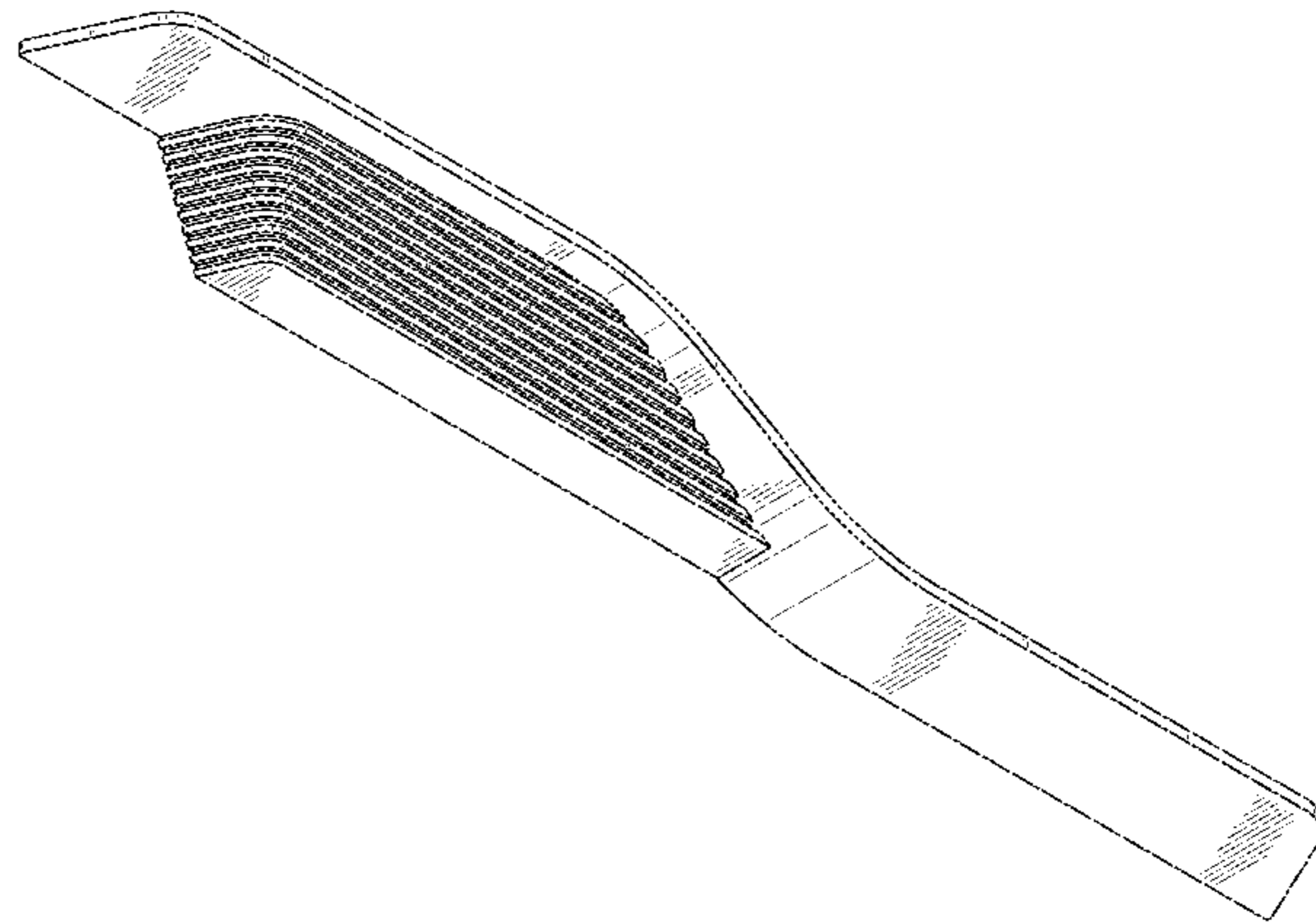
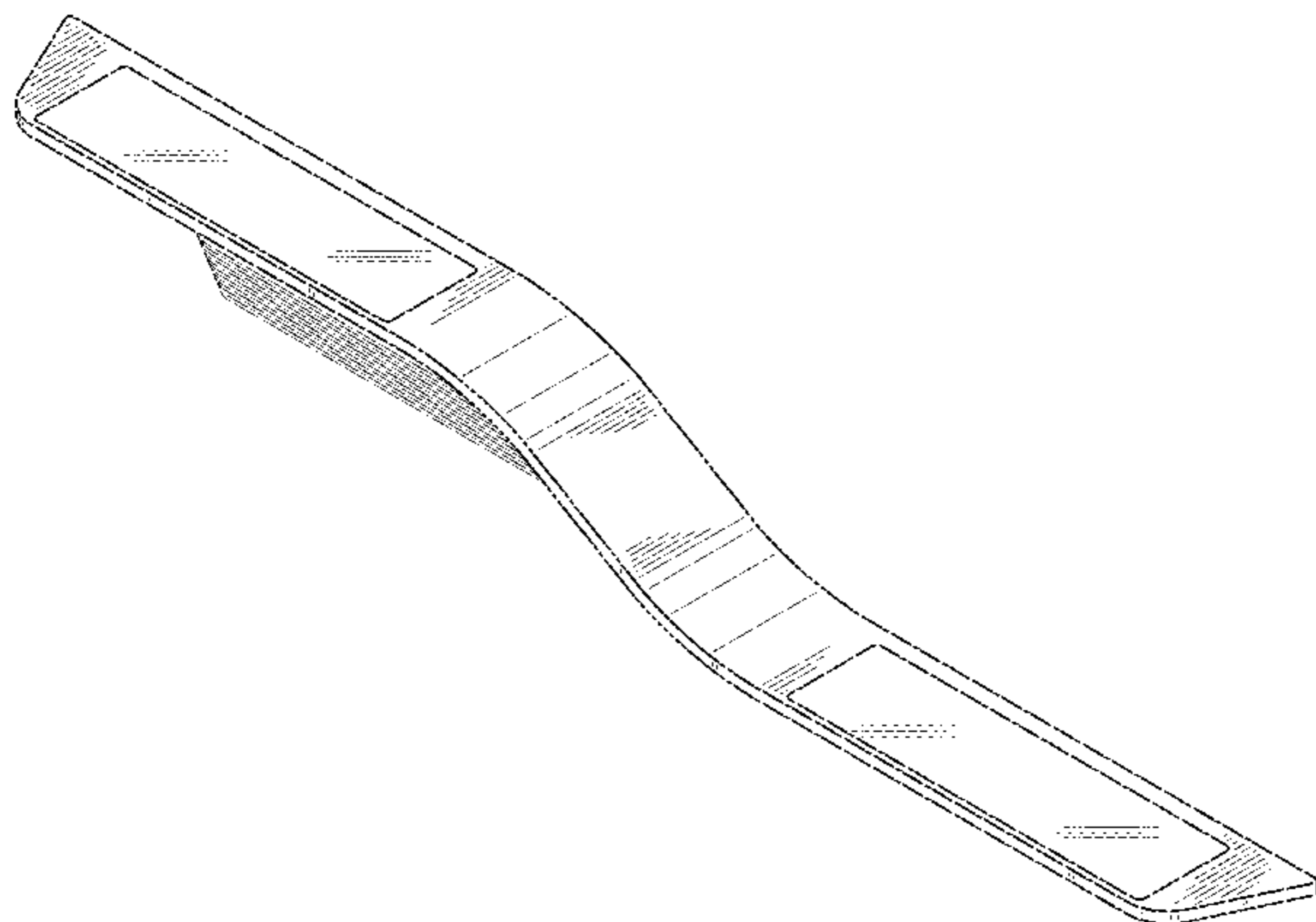

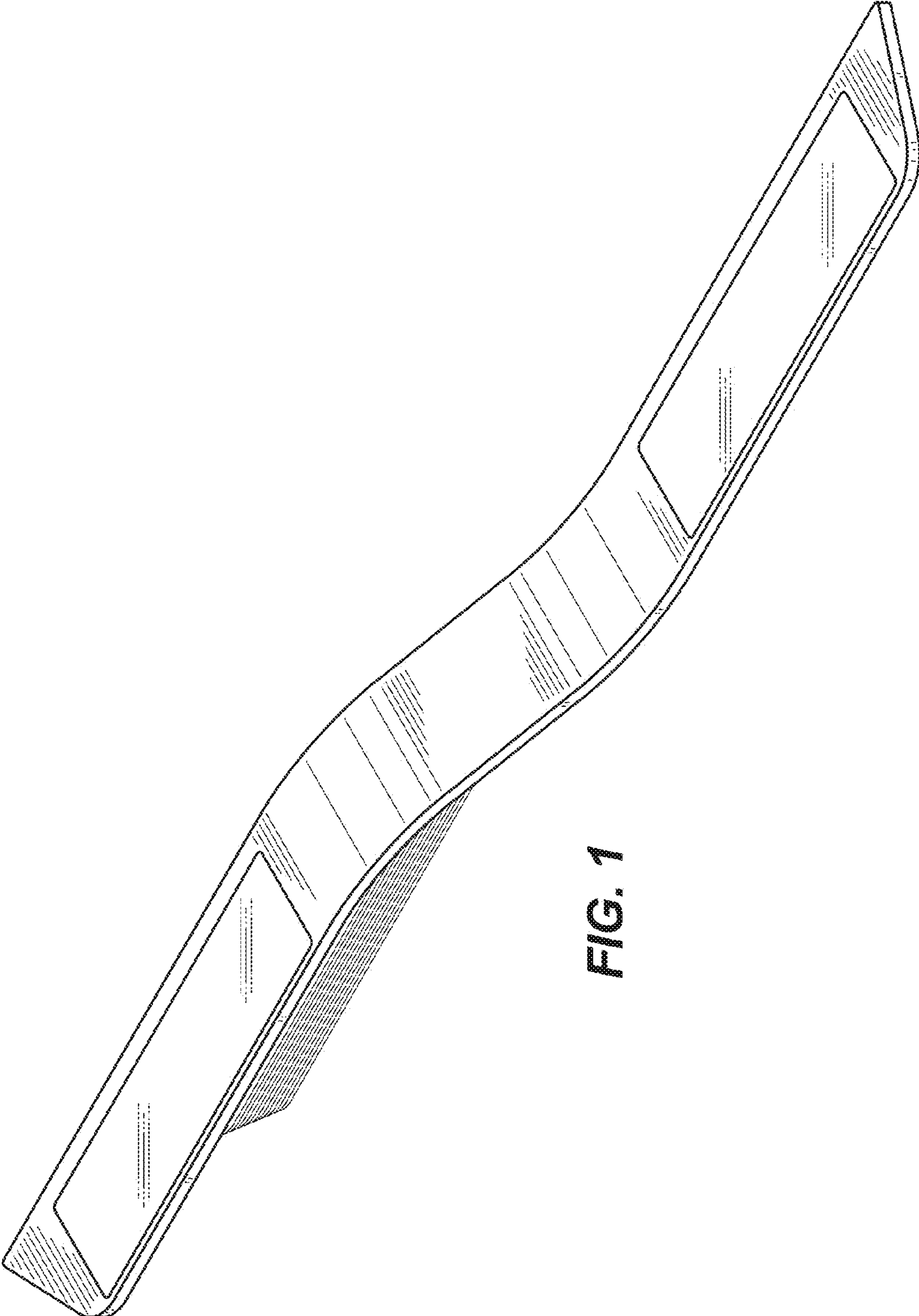

FIG. 1

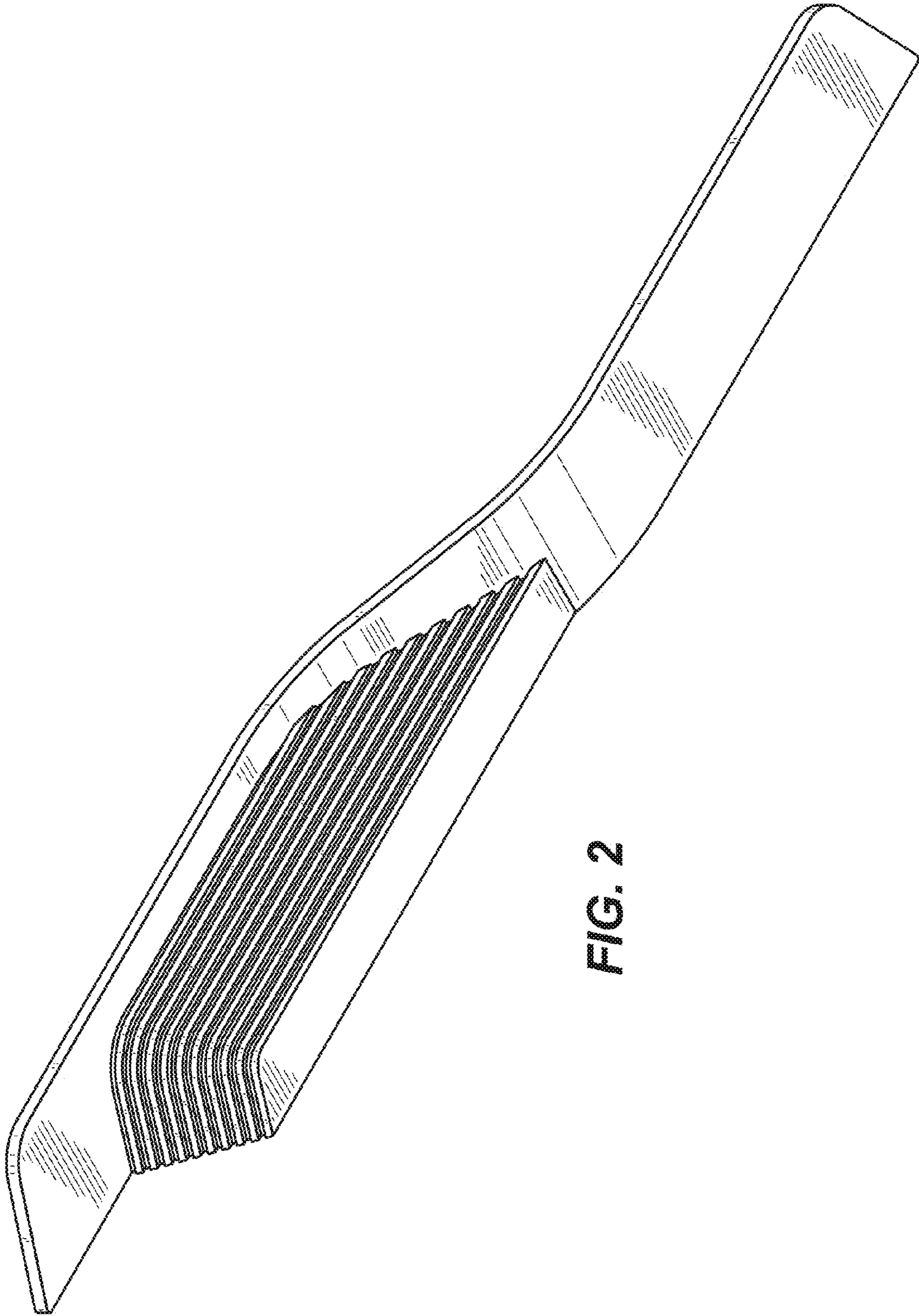

FIG. 2

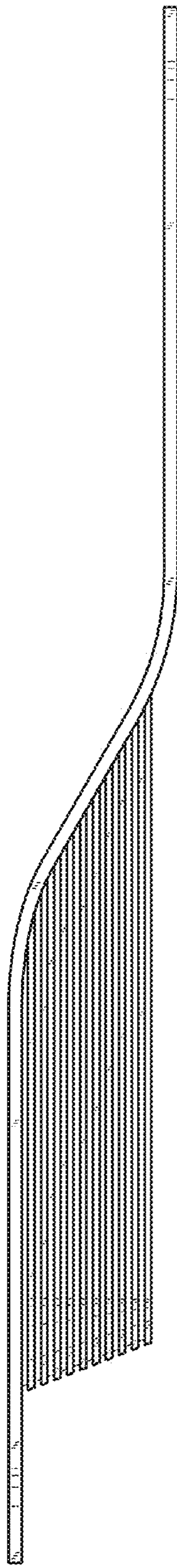

FIG. 3

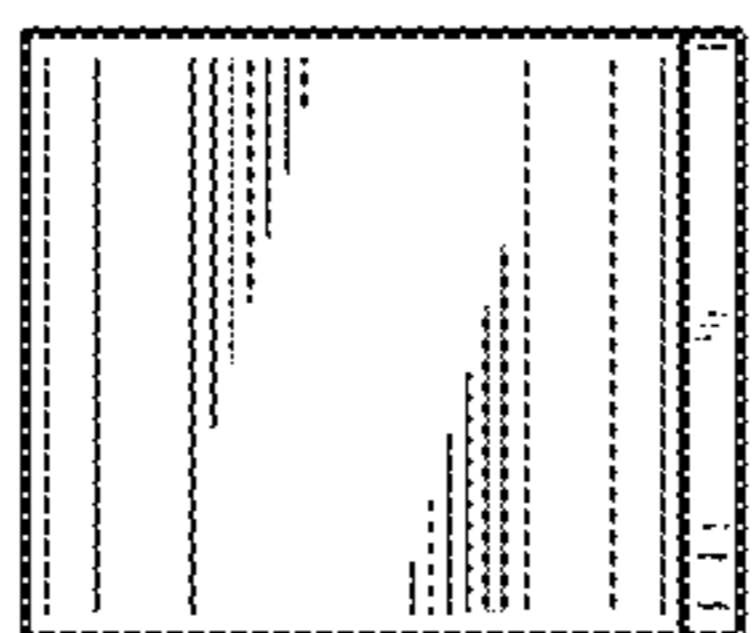
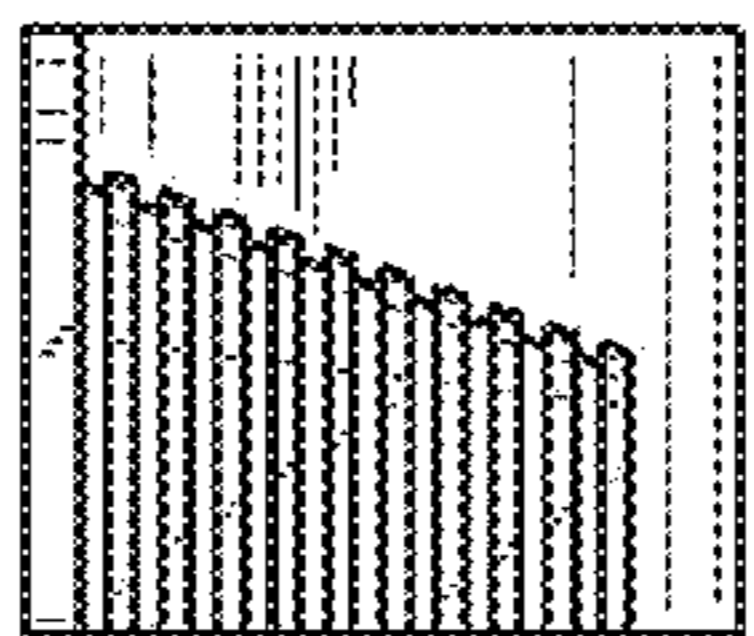

FIG. 4 FIG. 5

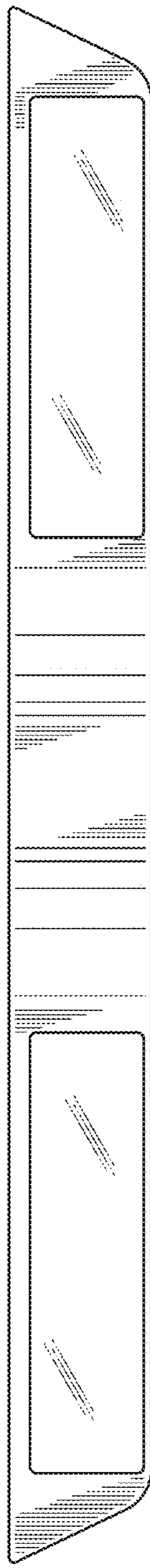

FIG. 6

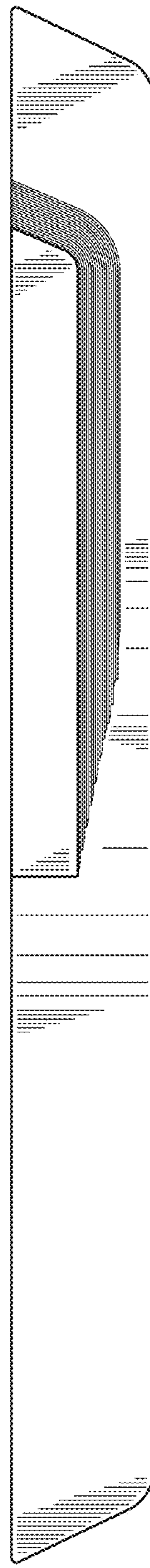

FIG. 7

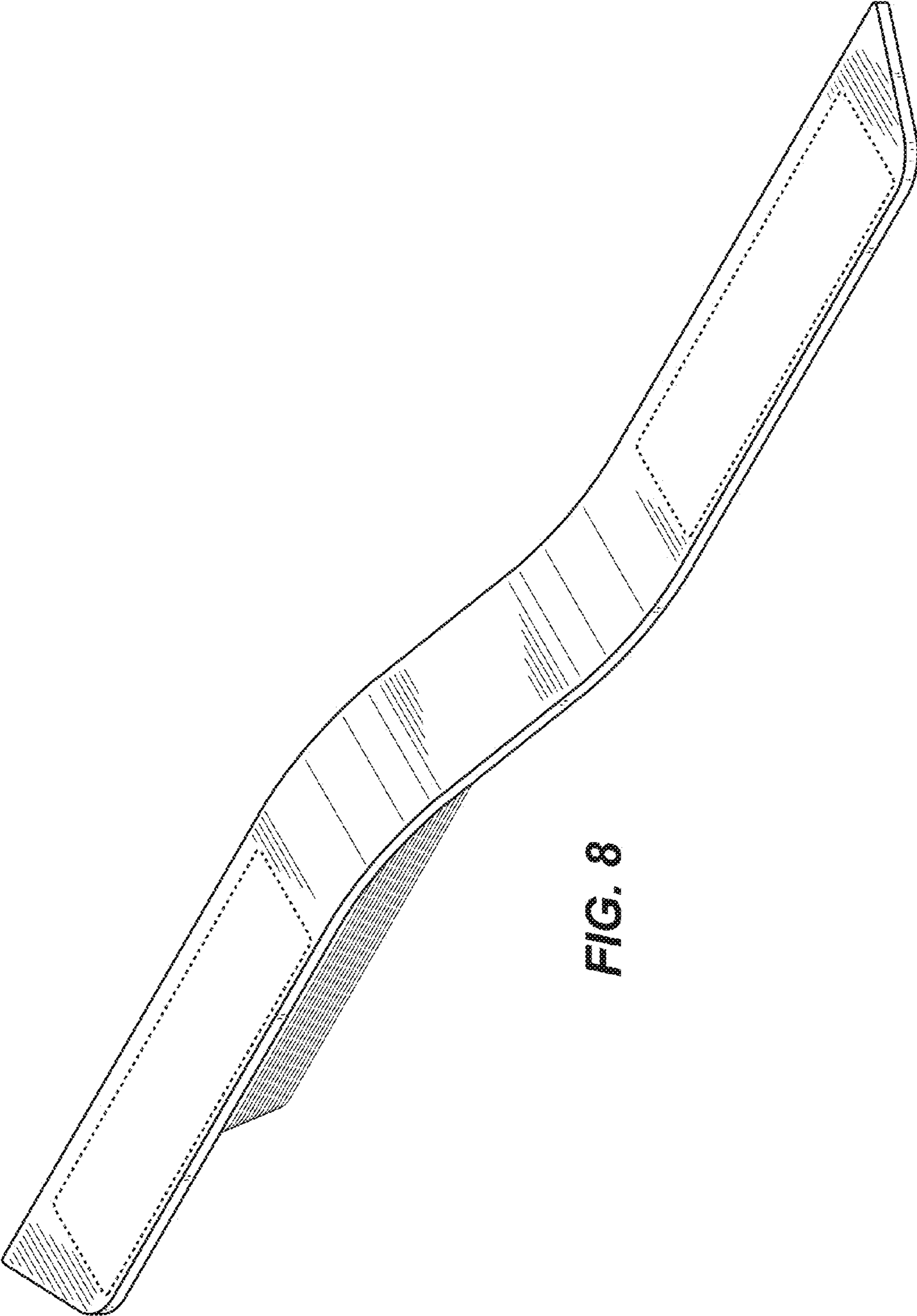

FIG. 8

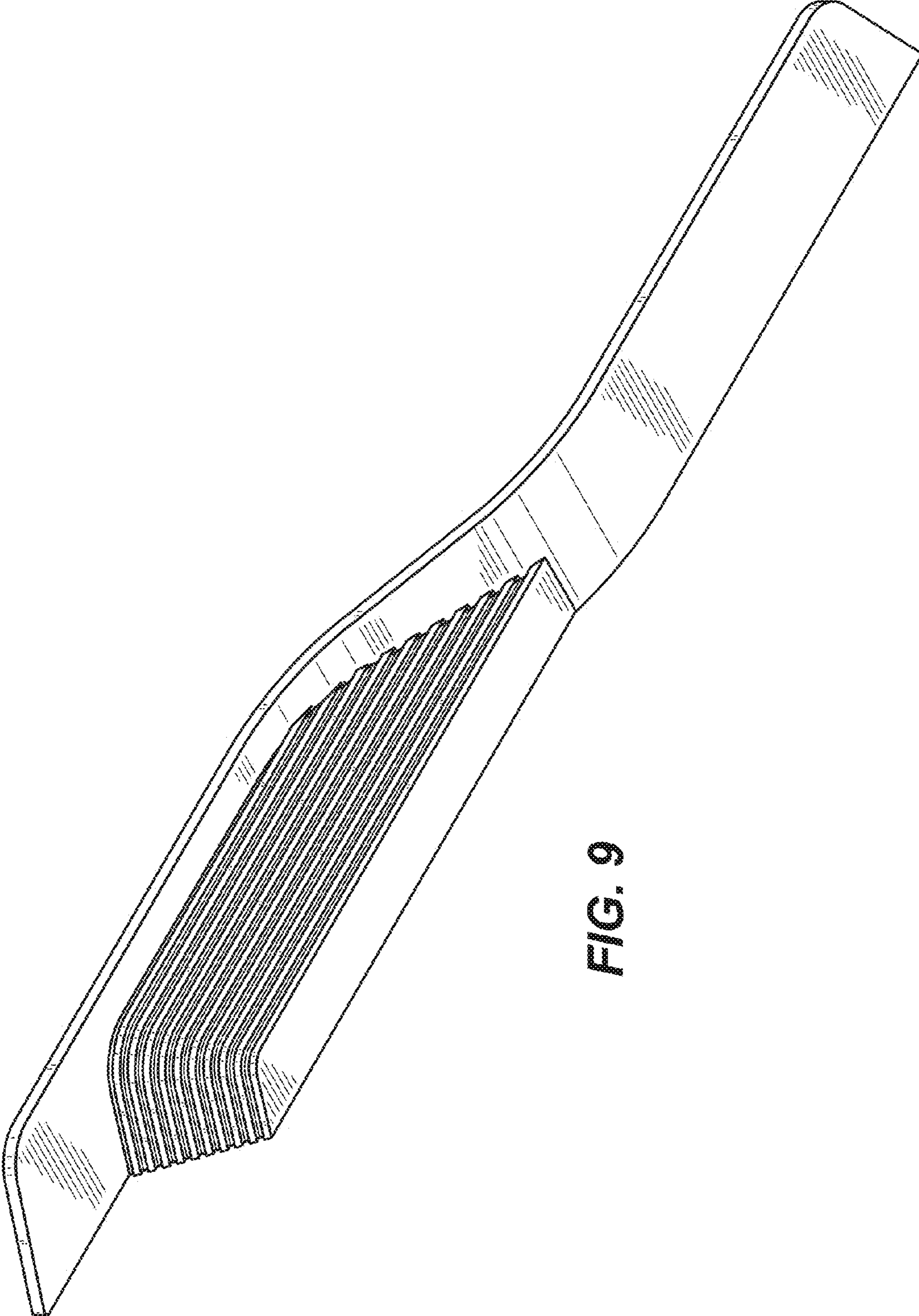

FIG. 9

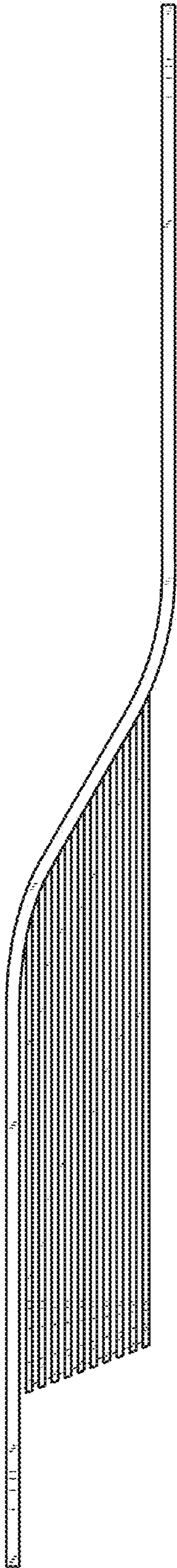

FIG. 10

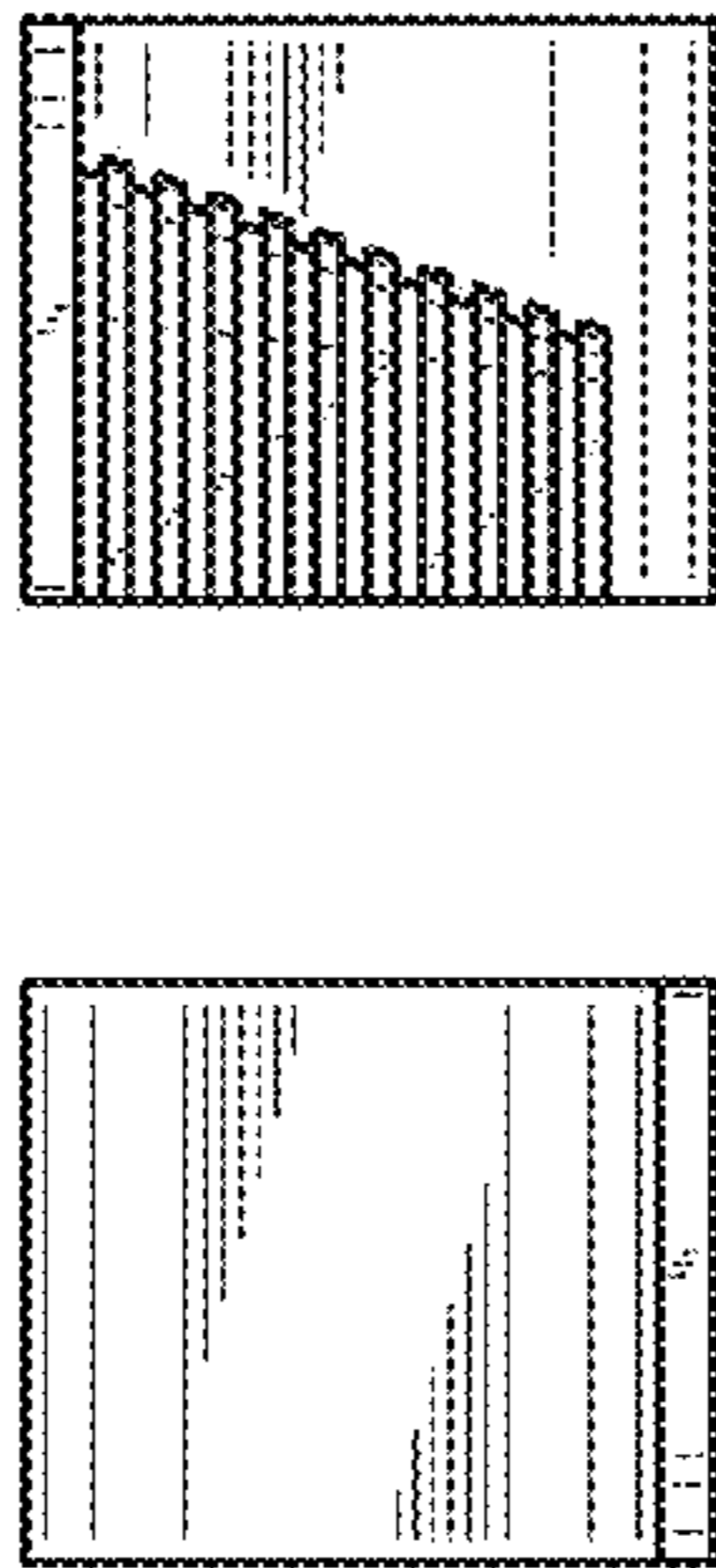

FIG. 11 FIG. 12

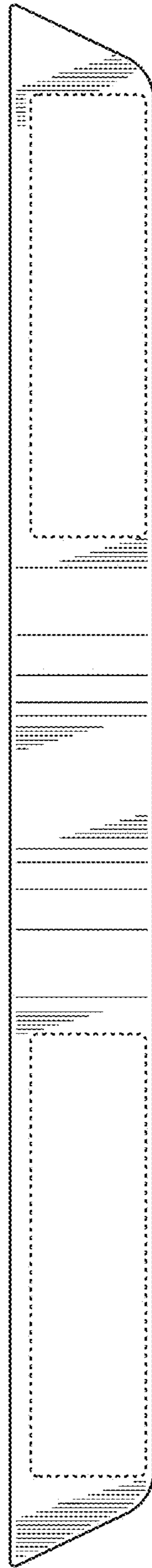

FIG. 13

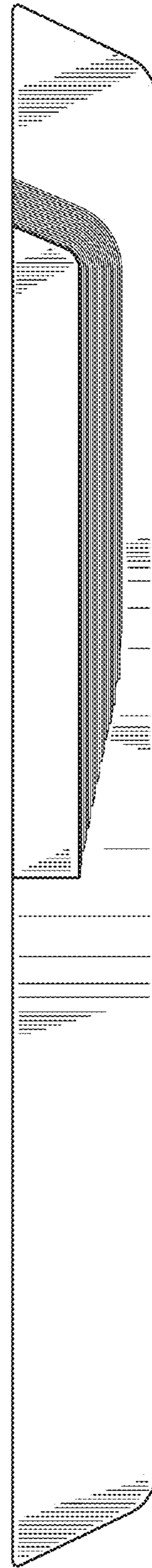

FIG. 14