



US00D742526S

(12) **United States Design Patent**
Haake et al.

(10) **Patent No.:** **US D742,526 S**
(45) **Date of Patent:** **** Nov. 3, 2015**

(54) **VETERINARY TABLE**

(71) Applicant: **SCHROER MANUFACTURING COMPANY**, Kansas City, KS (US)

(72) Inventors: **Lawrence Henry Haake**, Olathe, KS (US); **Robert Philip Eckwall**, Kansas City, MO (US); **Paul Waner Horner**, Overland Park, KS (US)

(73) Assignee: **SCHROER MANUFACTURING COMPANY**, Kansas City, KS (US)

(**) Term: **14 Years**

(21) Appl. No.: **29/494,624**

(22) Filed: **Jun. 23, 2014**

(51) **LOC (10) Cl.** **24-01**

(52) **U.S. Cl.**
USPC **D24/183**

(58) **Field of Classification Search**
USPC D24/183-185, 200, 158-159; D6/595, D6/596, 601, 604, 605, 336, 337, 345, 369, D6/367, 428, 387, 418; 5/110, 111, 5/600-602, 639, 640, 507.1, 611-614, 5/619; 108/27, 36, 57.25, 34, 43; 273/108, 108.1, 108.2, 309; 312/209; 463/46; 222/173; D21/397, 341
CPC A47B 9/10; A61D 3/00; A61G 13/04; A61G 13/06; A61B 6/0457; A61B 6/64
See application file for complete search history.

(56) **References Cited**

U.S. PATENT DOCUMENTS

1,166,018 A 12/1915 Soresi
1,648,631 A 11/1927 Austin
1,875,198 A 8/1932 Nagai
1,947,801 A 2/1934 Russell

1,980,848 A 11/1934 Cass
2,471,884 A 5/1949 Monnot
2,504,697 A 4/1950 Kearsley
3,092,079 A 6/1963 Stebel et al.

(Continued)

FOREIGN PATENT DOCUMENTS

GB 772032 4/1957

OTHER PUBLICATIONS

Shor-Line, "Rediscover Quality", 2011 Product Catalog, CoJack-Plus Multi-Purpose Table, p. 35, this item was on sale in the United States prior to Jun. 23, 2014, the filing date of this application.

(Continued)

Primary Examiner — Zenia Bennett

(74) *Attorney, Agent, or Firm* — Stinson Leonard Street LLP

(57) **CLAIM**

The ornamental design for a veterinary table, as shown and described.

DESCRIPTION

FIG. 1 is a front perspective view of the veterinary table; FIG. 2 is a top plan view of the veterinary table of FIG. 1; FIG. 3 is a bottom plan view of the veterinary table of FIG. 1; FIG. 4 is a front elevational view of the veterinary table of FIG. 1; FIG. 5 is a rear elevational view of the veterinary table of FIG. 1; FIG. 6 is a left side elevational view of the veterinary table of FIG. 1; and, FIG. 7 is a right side elevational view of the veterinary table of FIG. 1.

The broken lines shown in the drawings are included for the purpose of illustrating environment and form no part of the claimed design.

1 Claim, 6 Drawing Sheets

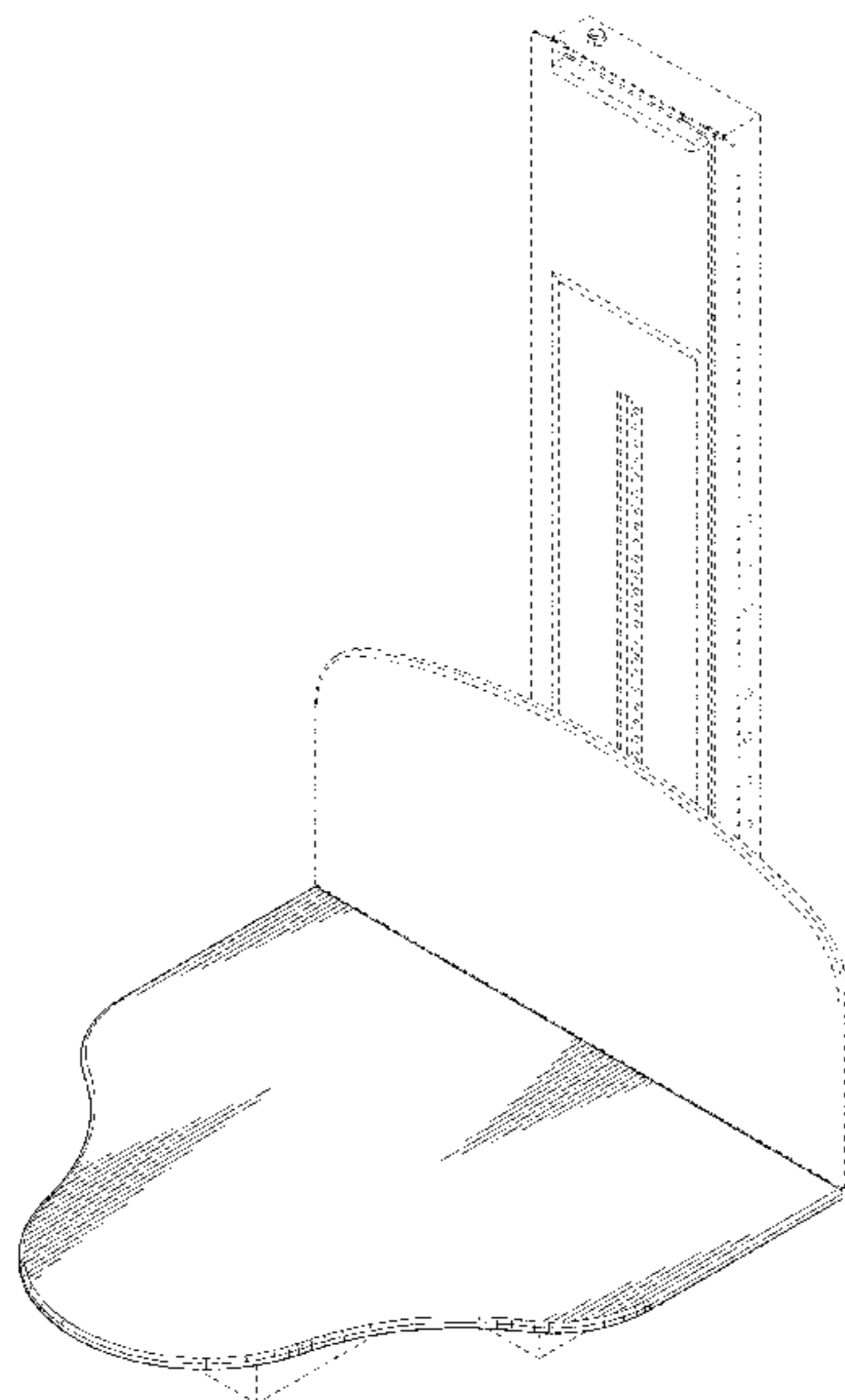

(56)

References Cited

U.S. PATENT DOCUMENTS

3,120,836	A	2/1964	Brauning	
3,217,672	A	11/1965	Haughey	
3,285,207	A	11/1966	Vom Hagen	
3,420,981	A	1/1969	Martinet	
3,617,693	A	11/1971	Shimosawa	
3,633,901	A	1/1972	Lindquist	
3,771,782	A	11/1973	Anderegg	
3,797,819	A *	3/1974	Platz	A61G 13/06 108/147
4,003,341	A	1/1977	La Croix	
D246,880	S	1/1978	Miola	
4,170,961	A	10/1979	Rosenberg et al.	
4,459,941	A	7/1984	Moffatt	
4,491,173	A	1/1985	Demand	
4,558,847	A	12/1985	Coates	
4,572,493	A	2/1986	Hubert	
D323,560	S	1/1992	Boyce et al.	
D327,792	S	7/1992	Tarlow	
5,156,166	A *	10/1992	Sebring	A61B 6/0457 378/209
D343,204	S	1/1994	Schrumer et al.	
5,324,911	A	6/1994	Cranston et al.	
D362,060	S	9/1995	Jacobs	
D368,935	S	4/1996	Cone, Jr.	
5,826,286	A *	10/1998	Cranston	A61D 3/00 108/2
5,833,200	A	11/1998	Patterson	
6,101,956	A	8/2000	Keil	
D439,670	S	3/2001	Sommer	
D441,868	S	5/2001	Rodenas Santiago et al.	
D453,968	S	2/2002	Zachrisson	
6,349,729	B1	2/2002	Meyer et al.	
6,435,110	B1	8/2002	Keil	
7,004,465	B2	2/2006	Keith	
7,073,464	B2	7/2006	Keith	
D541,549	S	5/2007	Ng et al.	
D555,243	S	11/2007	Linev	
7,373,676	B2	5/2008	Markovic et al.	
7,428,882	B2	9/2008	Keil	
D628,405	S	12/2010	Pippin	
D632,795	S	2/2011	Matrunola	
D663,428	S	7/2012	Goransson et al.	
8,210,109	B1 *	7/2012	Deweese	A47B 9/10 108/147
8,333,159	B2	12/2012	Schroer et al.	
8,443,761	B2 *	5/2013	Keil	119/753
D706,426	S	6/2014	Crow et al.	
2006/0230989	A1	10/2006	Haney et al.	
2007/0039523	A1	2/2007	Helzer et al.	
2007/0057450	A1	3/2007	Tsai	
2007/0125314	A1	6/2007	Keil	
2007/0245977	A1	10/2007	Keil	
2008/0067750	A1	3/2008	Voden	
2010/0222148	A1	9/2010	Kuhn et al.	
2011/0132931	A1	6/2011	Wright	

OTHER PUBLICATIONS

Shor-Line, "Rediscover Quality", 2011 Product Catalog, Mobile Animal Lift Table, p. 36, this item was on sale in the United States prior to Jun. 23, 2014, the filing date of this application.

Shor-Line, "Rediscover Quality", 2011 Product Catalog, Lift Exam Table, p. 36, this item was on sale in the United States prior to Jun. 23, 2014, the filing date of this application.

Shor-Line, "Rediscover Quality", 2011 Product Catalog, Shor-Line Classic Flat-Top Surgery Table, p. 43, this item was on sale in the United States prior to Jun. 23, 2014, the filing date of this application.

Shor-Line, "Rediscover Quality", 2011 Product Catalog, Shor-Line Classic V-Top Surgery Table, p. 43, this item was on sale in the United States prior to Jun. 23, 2014, the filing date of this application.

Groomer's Best, product information on "Fixed Exam Table", printed from the internet at <http://groomersbest.com/fixed-table/> on Oct. 6, 2011. This product information was available on the internet prior to Jun. 23, 2014, the filing date of this application.

Groomer's Best, product information on "Fold Up Exam Table", printed from the internet at <http://groomersbest.com/fold-up-exam-table/> on Oct. 6, 2011. This product information was available on the internet prior to Jun. 23, 2014, the filing date of this application.

Groomer's Best, product information on "Mobil Utility Table with Shelf", printed from the internet at <http://groomersbest.com/mobile-stainless-steel-table-with-shelf/> on Oct. 6, 2011. This product information was available on the internet prior to Jun. 23, 2014, the filing date of this application.

Groomer's Best, product information on "Foot Hydraulic or Electric Exam Table", printed from the internet at <http://groomersbest.com/foot-hydraulic-exam-table/> on Oct. 6, 2011. This product information was available on the internet prior to Jun. 23, 2014, the filing date of this application.

Suburban Surgical Co., Inc., Brochure, Premier Lift Tables, p. 120, this item was on sale in the United States prior to Jun. 23, 2014, the filing date of this application.

VSSI, Inc., Brochure, The Peninsula Folding Lift Table, this item was on sale in the United States prior to Jun. 23, 2014, the filing date of this application.

Welch Allyn, Brochure, "Morin Surgical Instruments", dated Nov. 1, 1994 (this document is in French but an English translation is also being provided) (5 pgs).

Shor-Line, Classic Flat-Top Surgery Table p. 56, printed from the internet at <http://shor-line.com/index.php/products/detail/34.html> on Jul. 15, 2014. This item was on sale in the United States prior to Jun. 23, 2014, the filing date of this application.

Shor-Line, Fold-Up Wall Mount Exam Table, p. 61, printed from the internet at <http://shor-line.com/index.php/products/detail/1050.html> on Jul. 15, 2014. This item was on sale in the United States prior to Jun. 23, 2014, the filing date of this application.

Shor-Line, The Classic Grooming Table, p. 92, printed from internet at <http://shor-line.com/index.php/products/detail/1012.html> on Jul. 15, 2014. This item was on sale in the United States prior to Jun. 23, 2014, the filing date of this application.

* cited by examiner

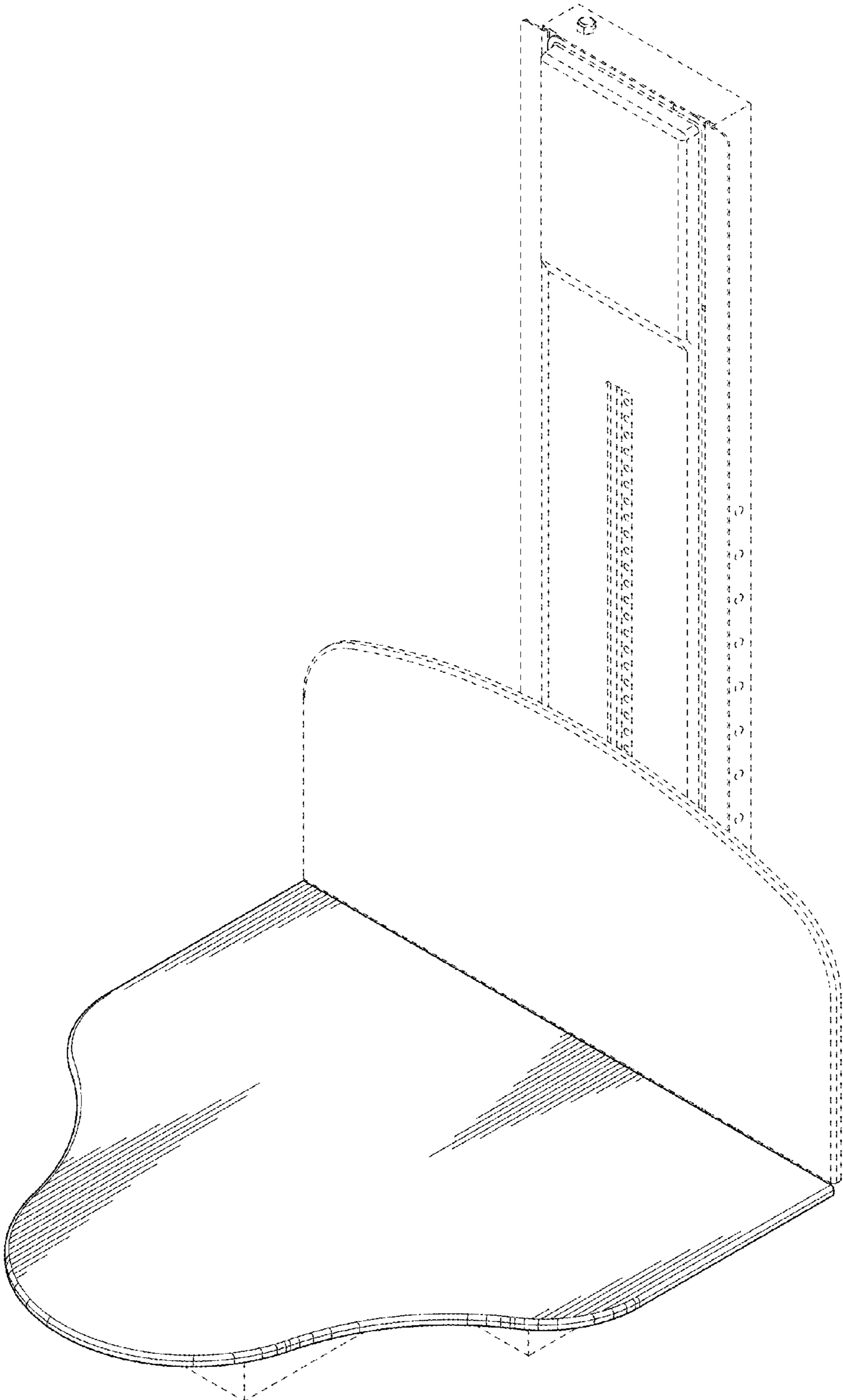

FIG. 1

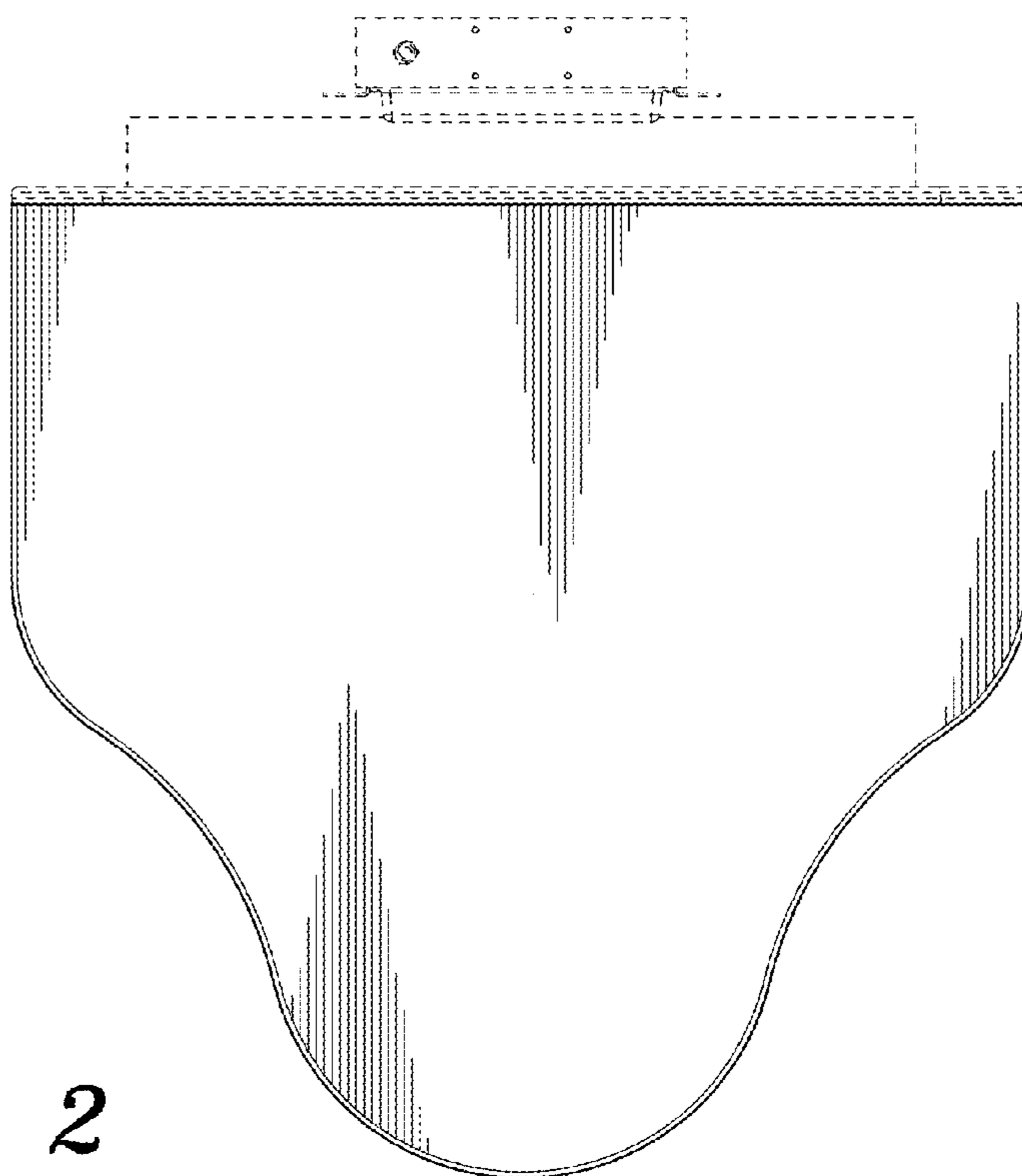

FIG. 2

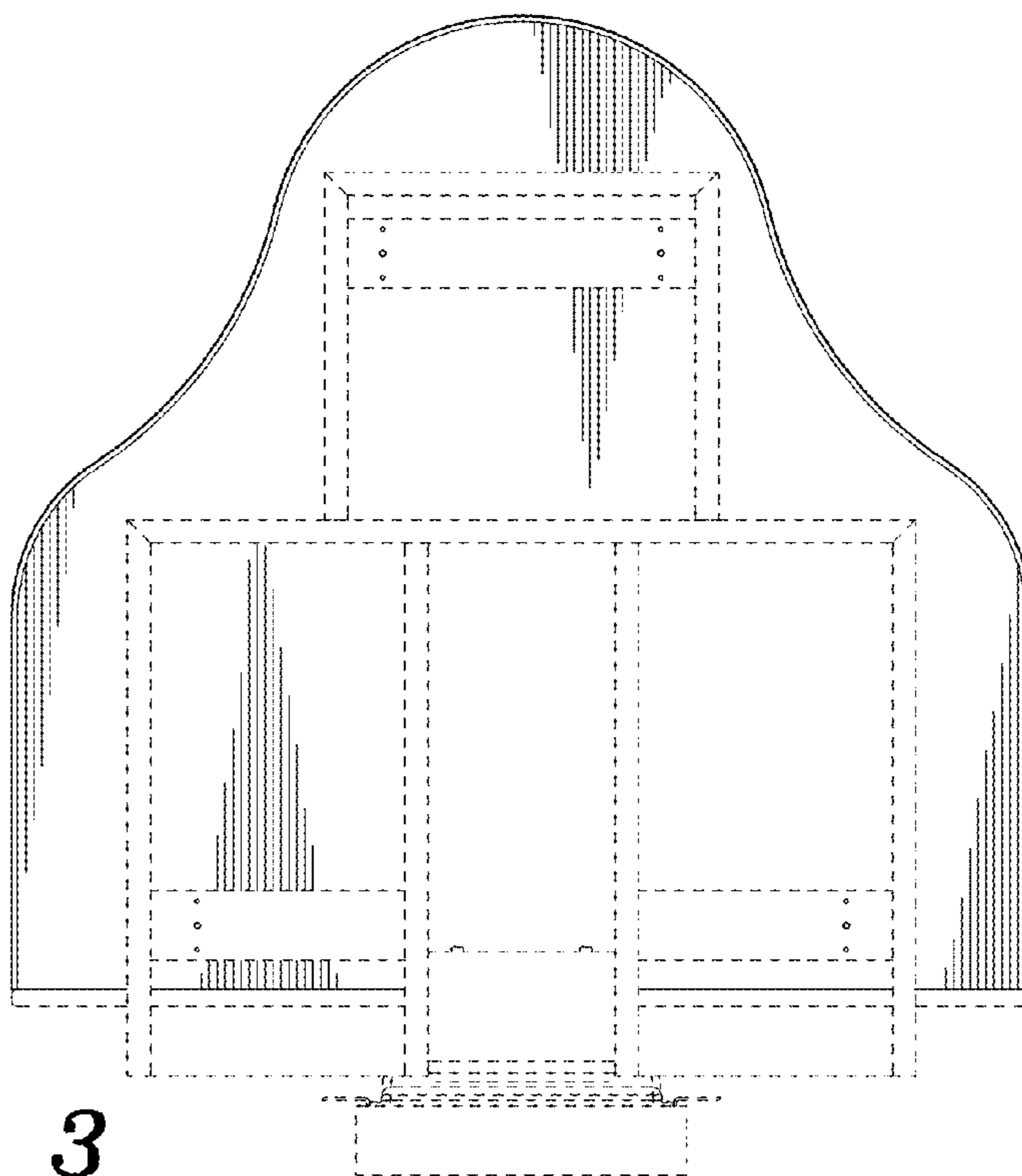

FIG. 3

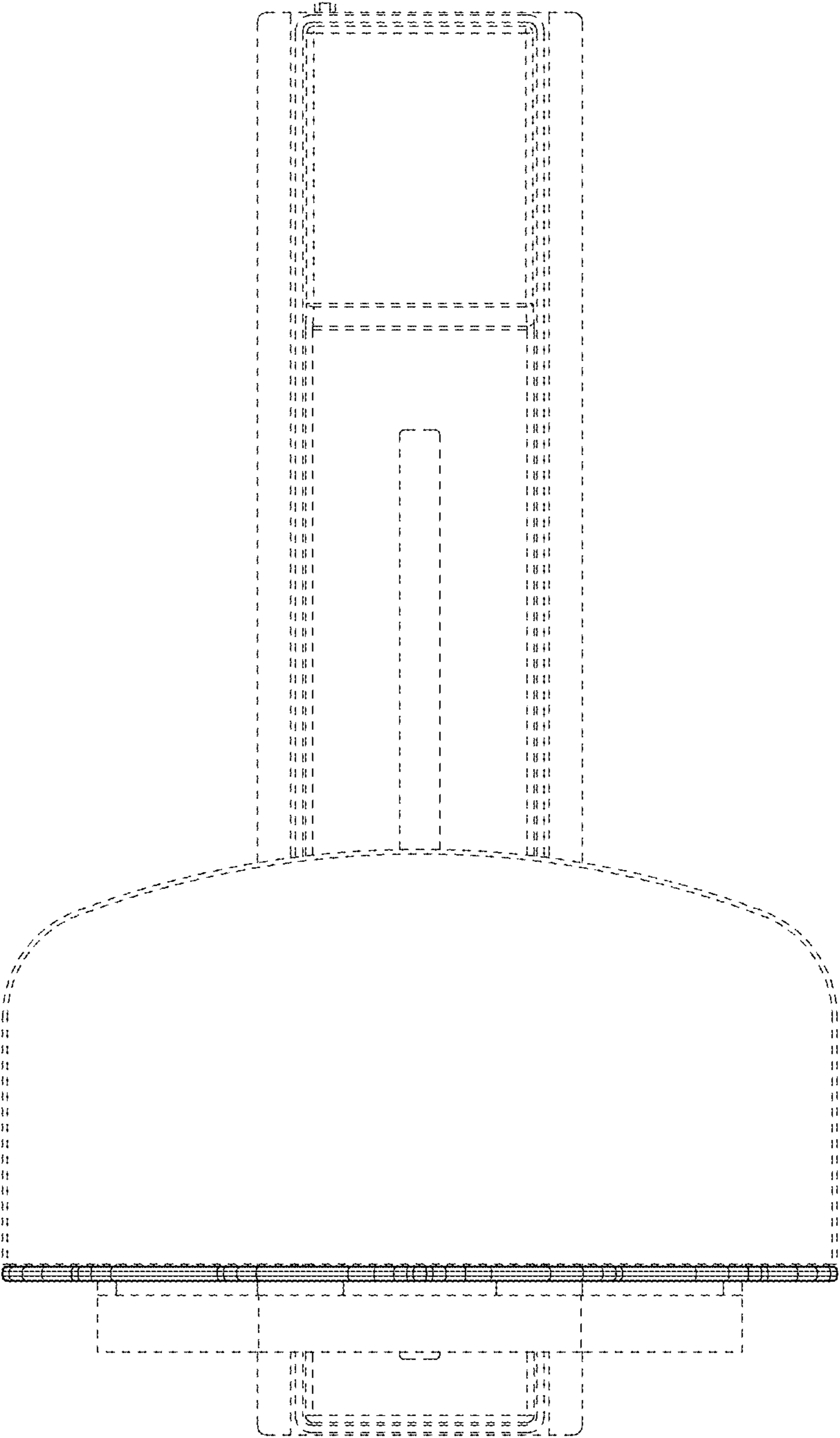

FIG. 4

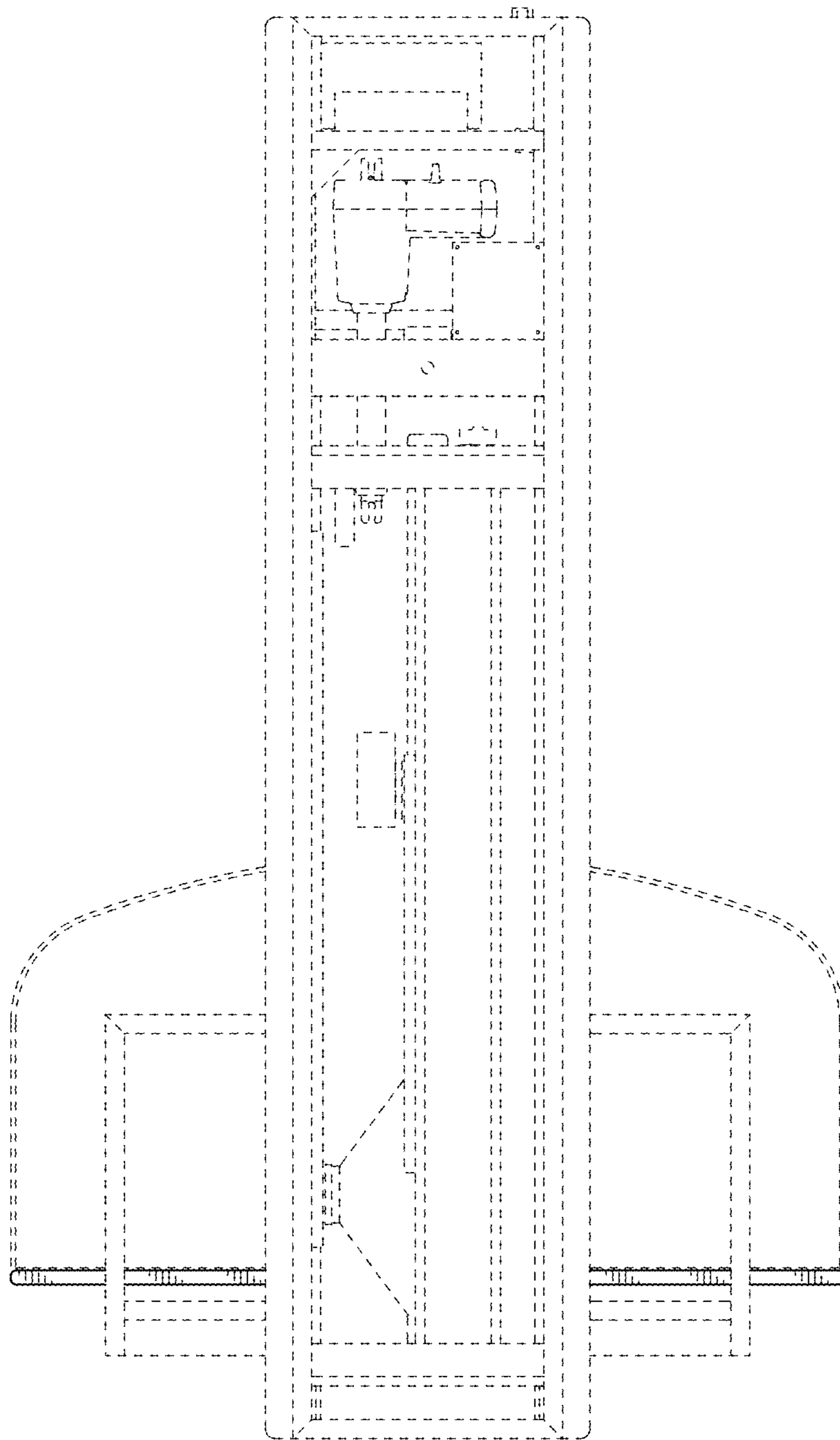

FIG. 5

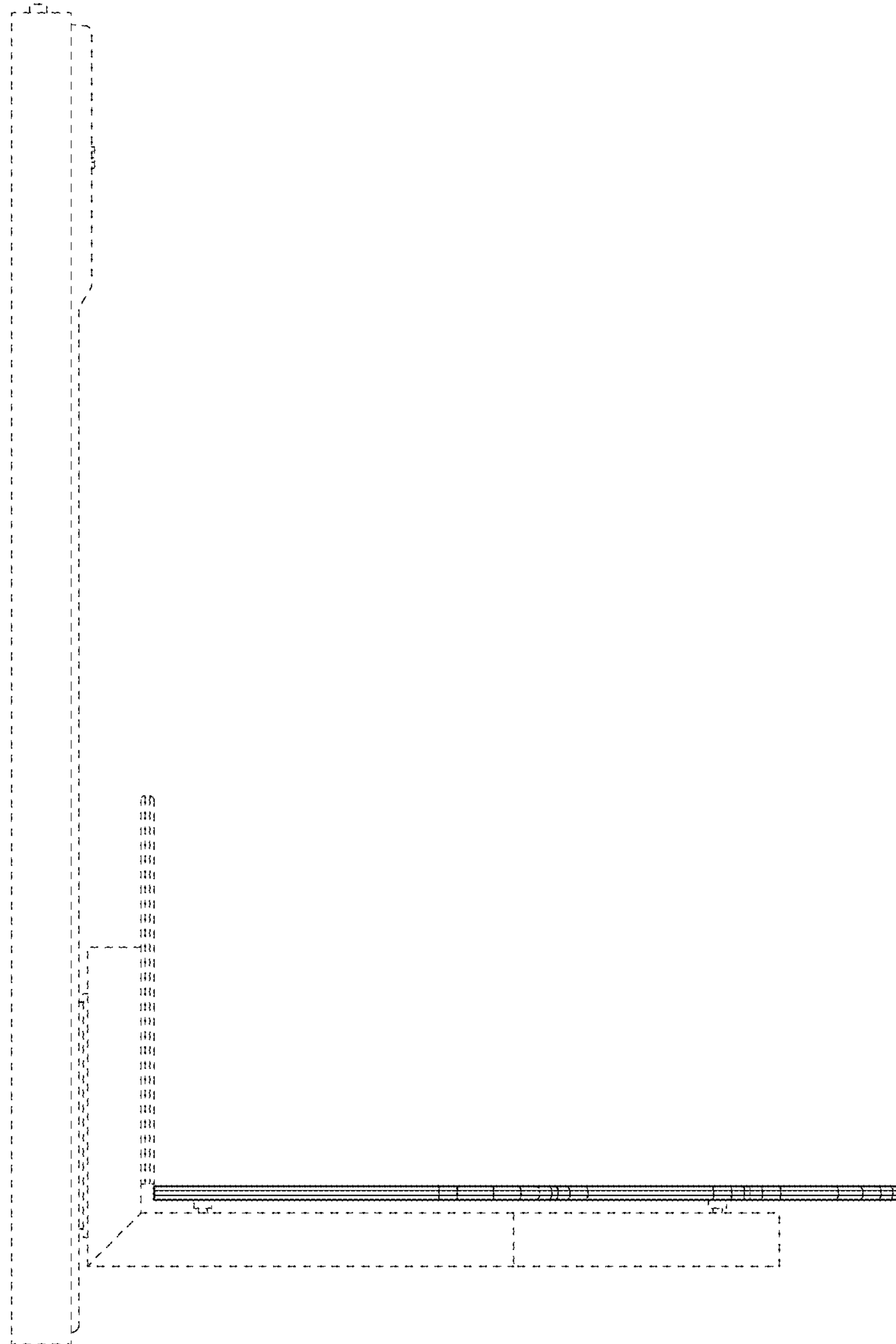

FIG. 6

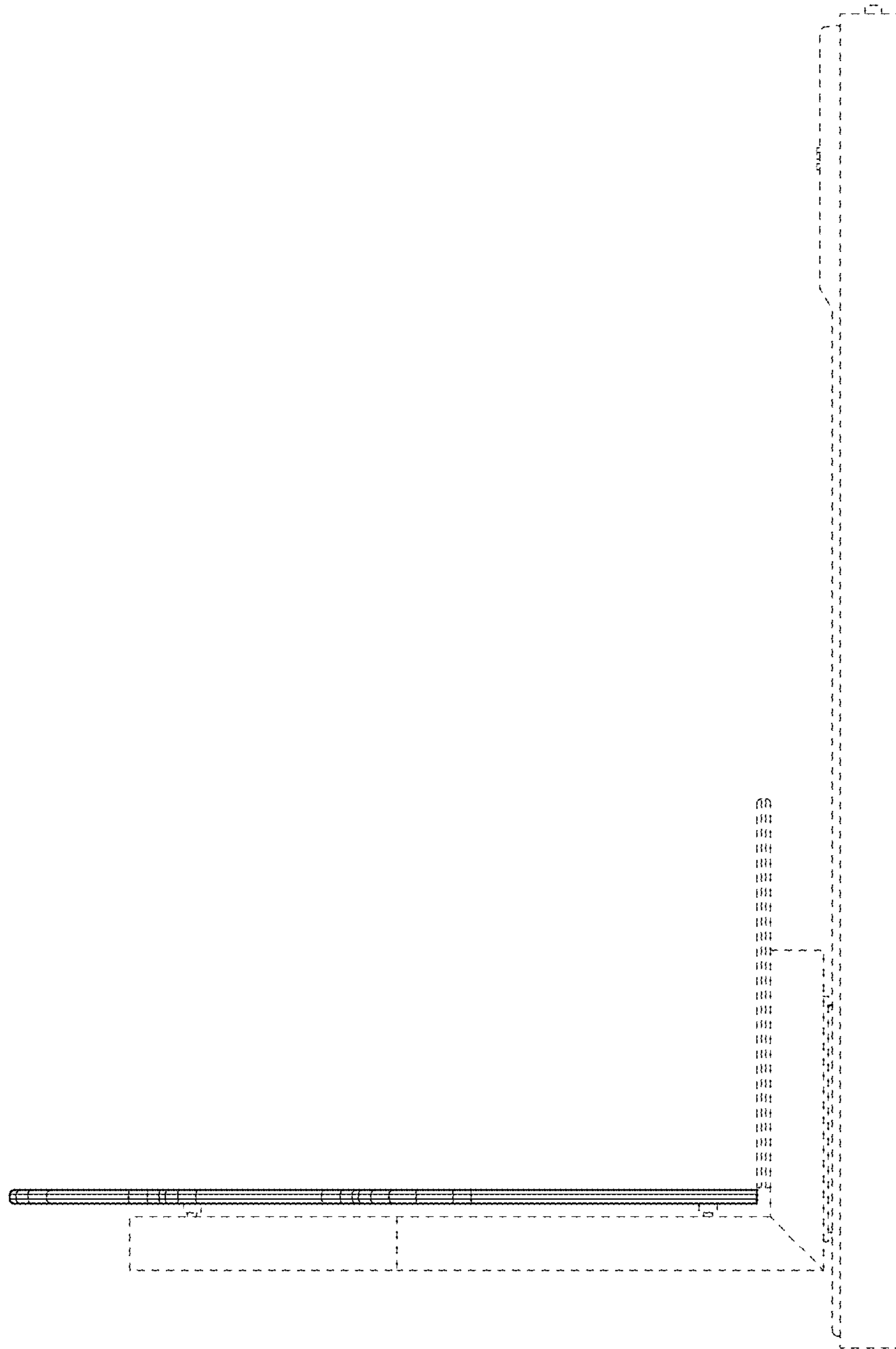

FIG. 7