



US00D742519S

(12) **United States Design Patent**  
**Sul**

(10) **Patent No.:** **US D742,519 S**

(45) **Date of Patent:** **\*\* Nov. 3, 2015**

(54) **HIGH FREQUENCY COIL FOR MAGNETIC  
RESONANCE IMAGE DEVICE**

(56) **References Cited**

U.S. PATENT DOCUMENTS

(71) Applicant: **Samsung Electronics Co., Ltd.,**  
Suwon-si (KR)

5,517,120	A *	5/1996	Misic et al.	600/422
5,664,568	A *	9/1997	Srinivasan et al.	600/422
6,356,081	B1 *	3/2002	Misic	600/422
D513,533	S *	1/2006	Iwasaki et al.	D24/158
7,333,849	B1 *	2/2008	Su et al.	600/422
D563,556	S *	3/2008	Baba	D24/158
7,526,330	B1 *	4/2009	Randell et al.	600/421
D591,862	S *	5/2009	Taniguchi et al.	D24/158
D592,751	S *	5/2009	Ninomiya et al.	D24/158
2008/0275332	A1 *	11/2008	Alradady et al.	600/422
2009/0171189	A1 *	7/2009	Li et al.	600/422

(72) Inventor: **Sung Woo Sul**, Yongin-si (KR)

(73) Assignee: **SAMSUNG ELECTRONICS CO.,  
LTD.** (KR)

(\*\*) Term: **14 Years**

\* cited by examiner

(21) Appl. No.: **29/513,396**

*Primary Examiner* — Anhdao Doan

(22) Filed: **Dec. 30, 2014**

(74) *Attorney, Agent, or Firm* — Cantor Colburn LLP

(30) **Foreign Application Priority Data**

(57) **CLAIM**

Jul. 2, 2014 (KR) ..... 30-2014-0032557

(51) **LOC (10) Cl.** ..... **24-01**

I claim, the ornamental design for high frequency coil for magnetic resonance image device, as shown and described.

(52) **U.S. Cl.**

USPC ..... **D24/158**

**DESCRIPTION**

(58) **Field of Classification Search**

USPC ..... D24/158-161, 185, 186; 378/4, 21-27,  
378/38, 40, 102, 196-198; 600/410, 422

CPC ..... A61B 5/05; A61B 5/055

See application file for complete search history.

FIG. 1 is a front perspective view of high frequency coil for magnetic resonance image device showing my new design; FIG. 2 is a front view thereof; FIG. 3 is a rear view thereof; FIG. 4 is a side view thereof; FIG. 5 is a side view thereof; FIG. 6 is a top plan view thereof; and, FIG. 7 is a bottom plan view thereof. The broken lines are for environmental purposes only and form no part of the claimed design.

**1 Claim, 7 Drawing Sheets**

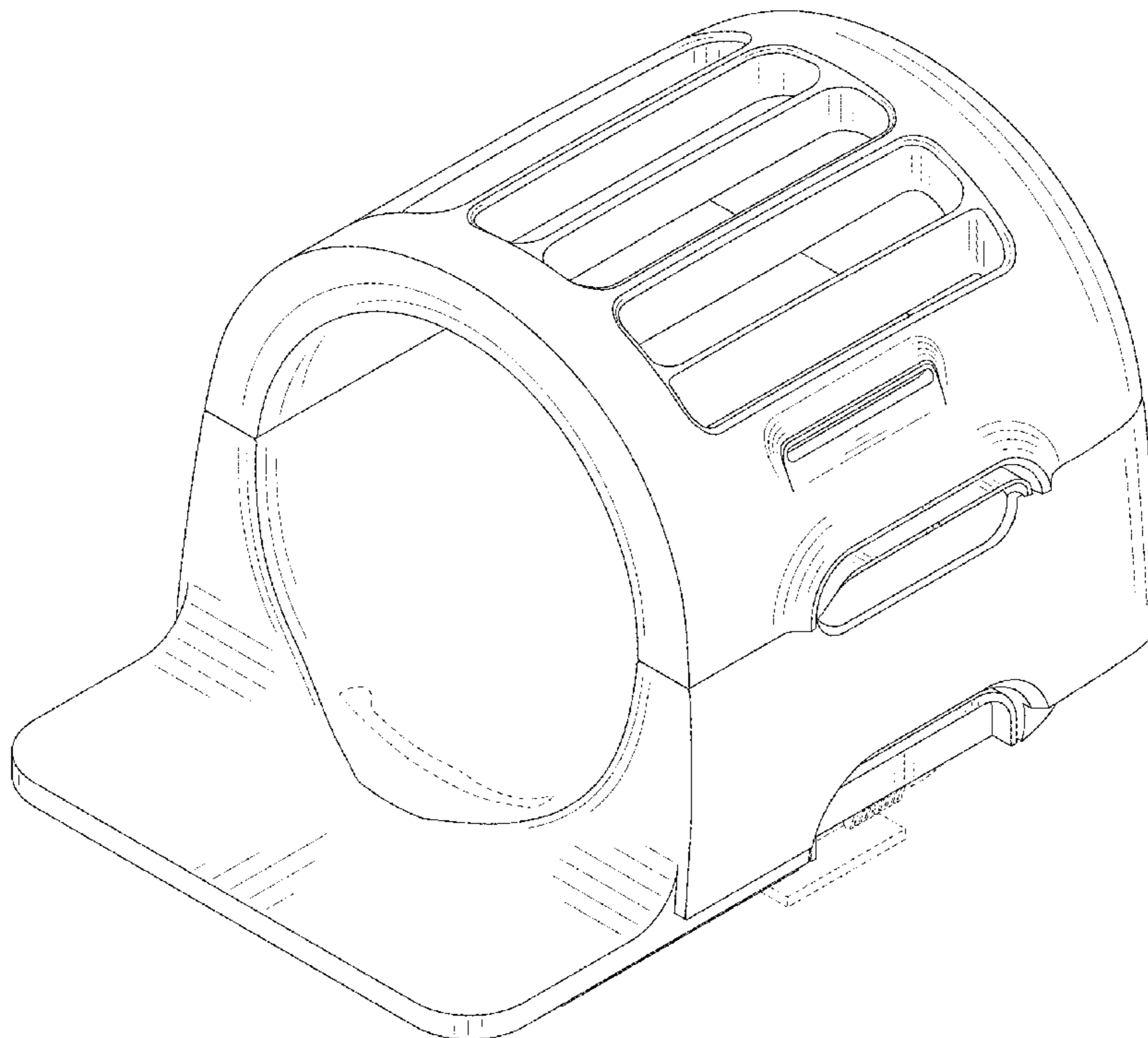

FIG. 1

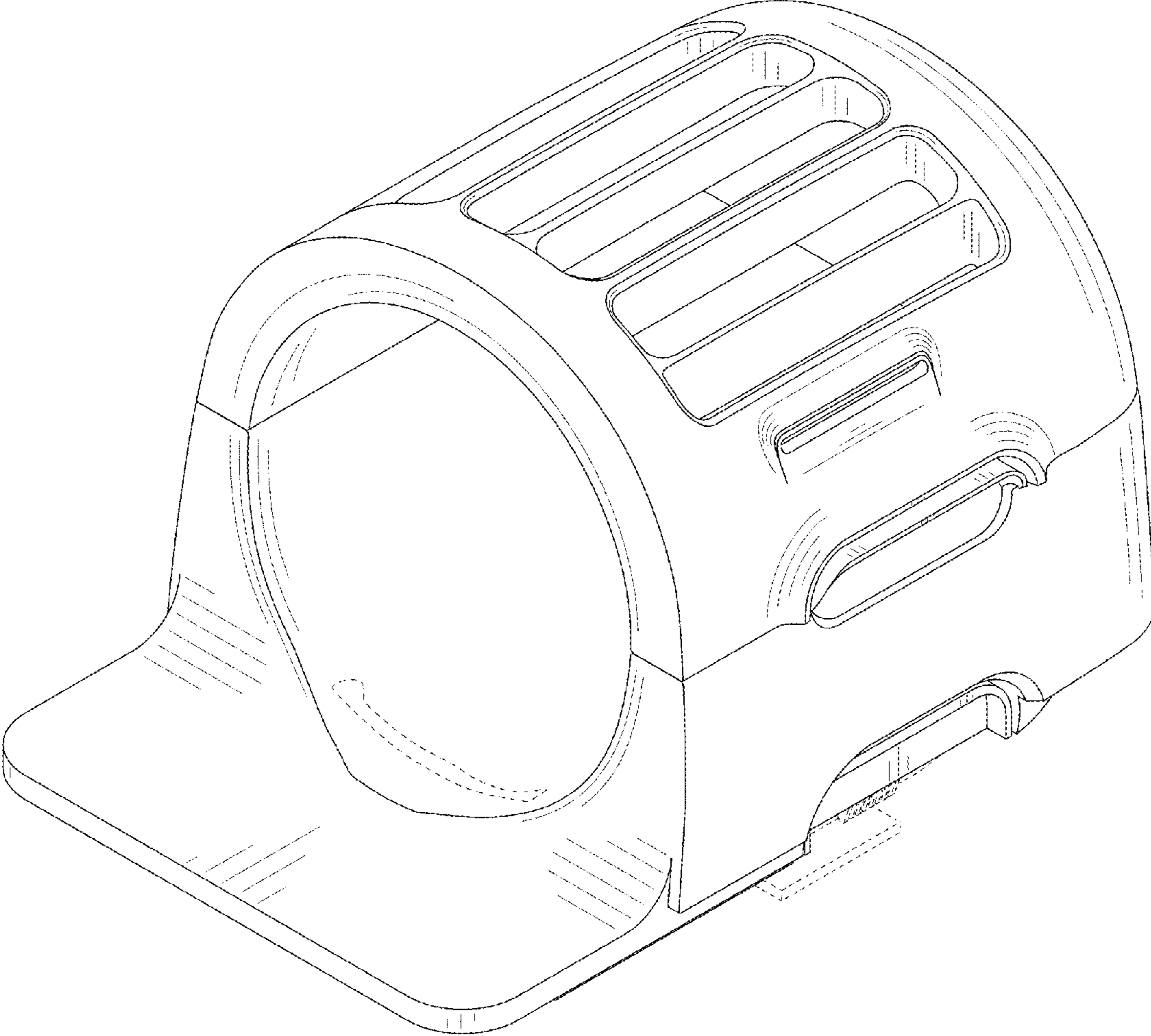

FIG. 2

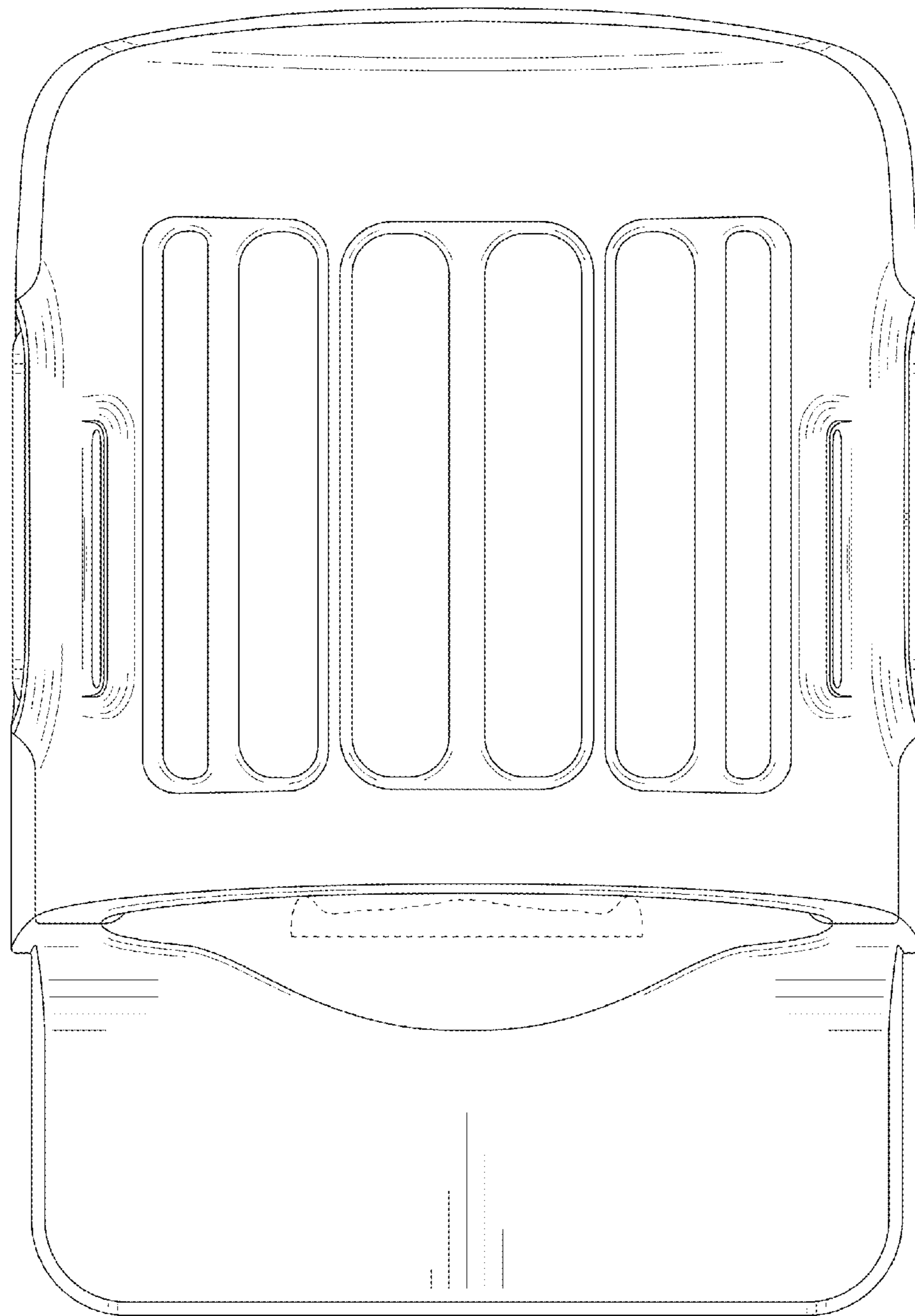

FIG. 3

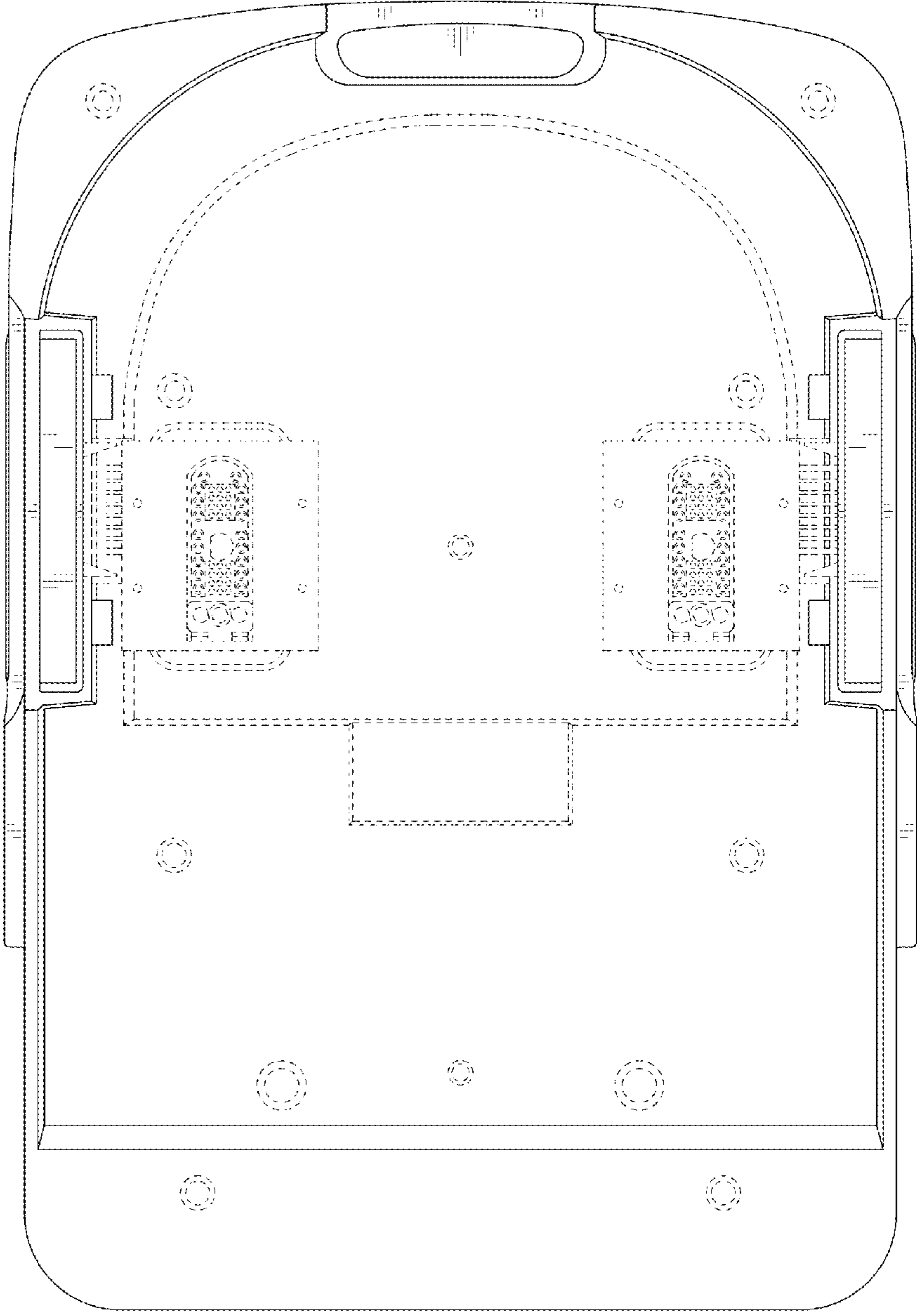

FIG. 4

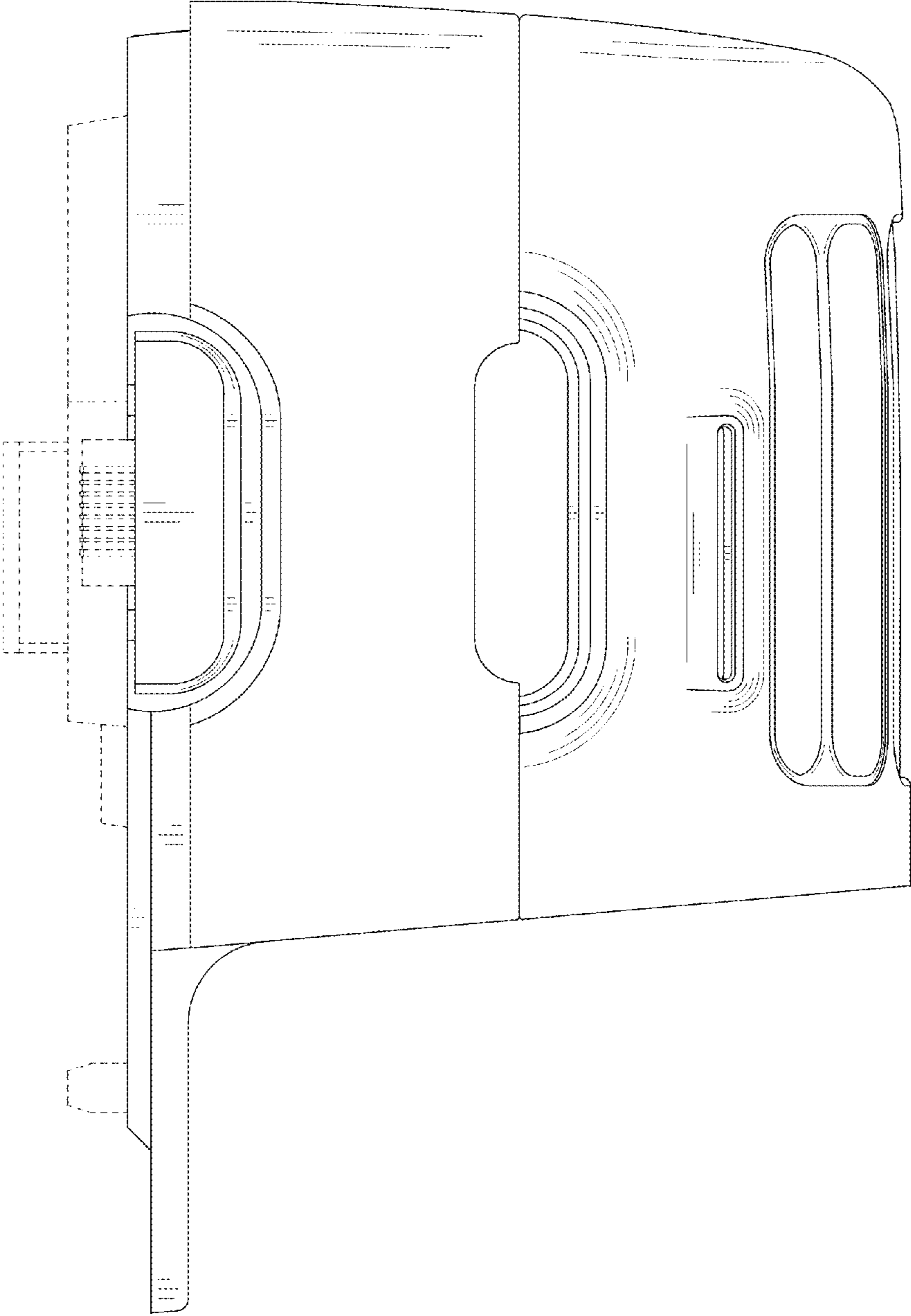



FIG. 5

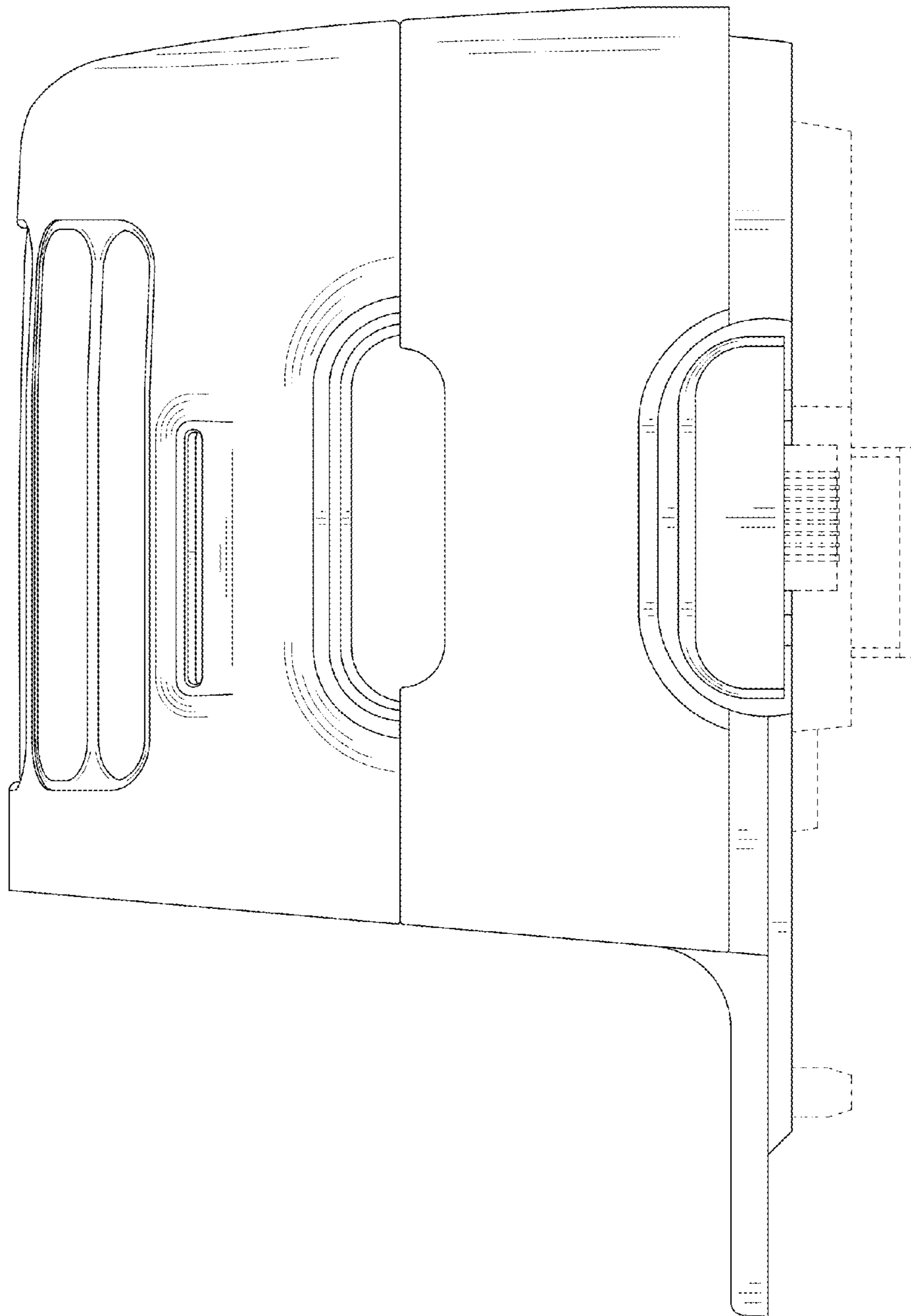

FIG. 6

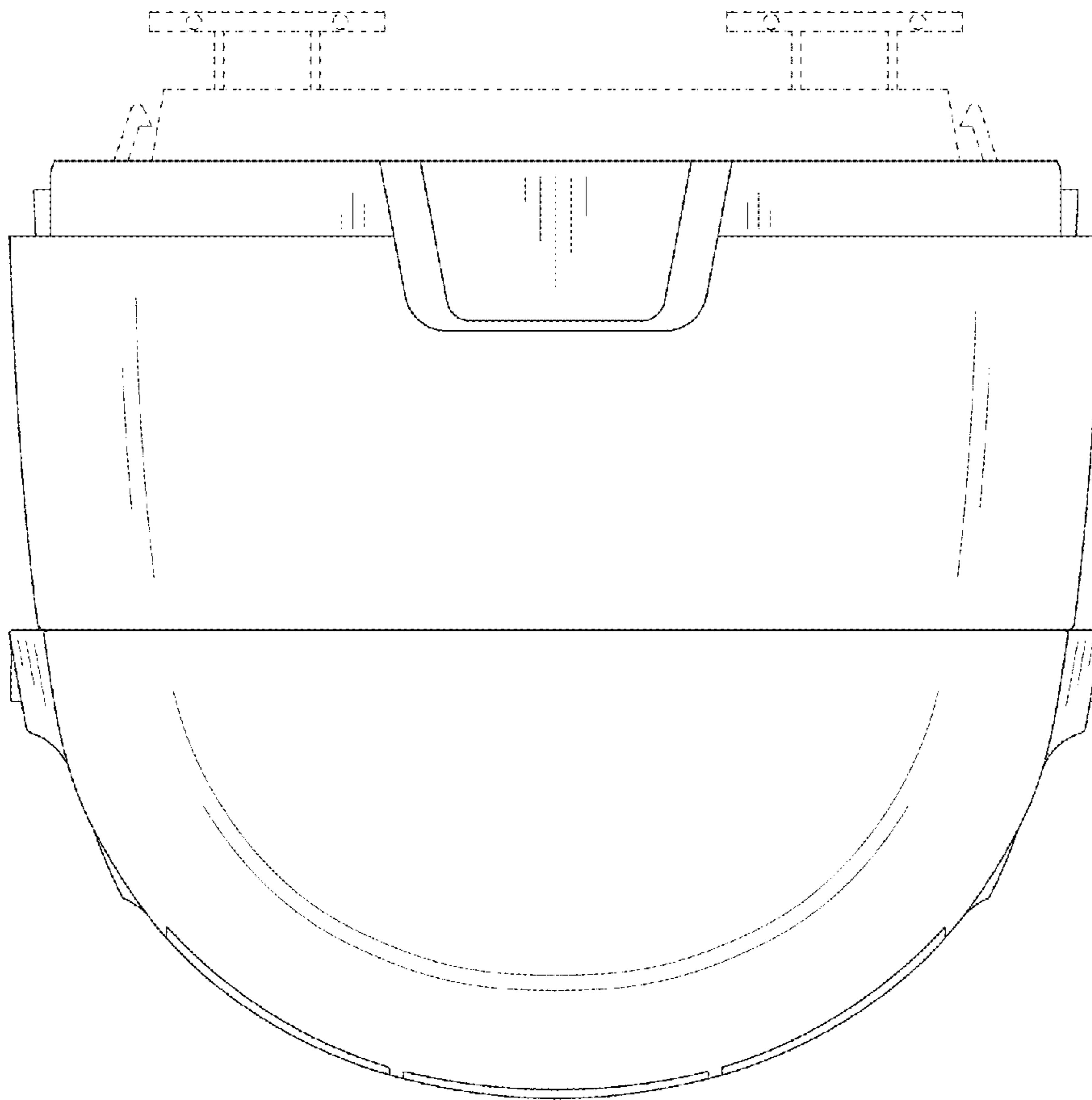

FIG. 7

