



US00D742492S

(12) **United States Design Patent**
Robinson et al.

(10) **Patent No.:** **US D742,492 S**
(45) **Date of Patent:** **** Nov. 3, 2015**

(54) **REMOVABLE TOP FOR A PORTABLE VAPORIZER**

(75) Inventors: **Alexander Robinson**, San Francisco, CA (US); **Joseph Taylor**, San Francisco, CA (US); **Mark Williams**, San Francisco, CA (US)

(73) Assignee: **NWT Holdings, LLC**, Seattle, WA (US)

(**) Term: **14 Years**

(21) Appl. No.: **29/413,429**

(22) Filed: **Feb. 15, 2012**

(51) **LOC (10) Cl.** **23-04**

(52) **U.S. Cl.**
USPC **D23/360**

(58) **Field of Classification Search**
USPC D23/355–366, 352, 369, 332, 333, 335, D23/336, 342, 351; 422/120, 122; 55/356, 55/473, 504; 96/97; 261/DIG. 17, DIG. 65, 261/DIG. 88, DIG. 31; D14/188, 170, 172; D18/34.6
CPC A24F 47/008; A24F 1/30; A24F 47/00; A24F 3/00; A24F 9/10; A24F 1/10; A24D 1/10

See application file for complete search history.

(56) **References Cited**

U.S. PATENT DOCUMENTS

| | | | |
|-----------|----|---------|------------------|
| 4,303,083 | A | 12/1981 | Burruss, Jr. |
| 5,388,594 | A | 2/1995 | Counts et al. |
| 5,464,026 | A | 11/1995 | Gardner et al. |
| 5,564,442 | A | 10/1996 | MacDonald et al. |
| 6,095,153 | A | 8/2000 | Kessler et al. |
| 6,250,301 | B1 | 6/2001 | Pate |
| 6,513,524 | B1 | 2/2003 | Storz |
| 6,598,607 | B2 | 7/2003 | Adiga et al. |
| D489,448 | S | 5/2004 | Shayan |
| 6,761,164 | B2 | 7/2004 | Amirpour et al. |

| | | | | |
|-----------|------|---------|-----------|---------|
| 6,772,756 | B2 | 8/2004 | Shayan | |
| D502,936 | S * | 3/2005 | Oas | D14/188 |
| D508,119 | S | 8/2005 | Shayan | |
| D513,070 | S * | 12/2005 | Haranaka | D23/355 |
| 6,990,978 | B2 | 1/2006 | Shayan | |
| D523,414 | S * | 6/2006 | Kobayashi | D14/188 |
| D532,406 | S * | 11/2006 | Lee | D14/188 |
| D536,090 | S | 1/2007 | Nelson | |
| D581,506 | S | 11/2008 | Kelnhofer | |
| 7,490,613 | B2 | 2/2009 | Iordan | |
| D603,033 | S | 10/2009 | Kelnhofer | |
| 7,753,055 | B2 * | 7/2010 | Bryman | 131/351 |
| D625,398 | S * | 10/2010 | Choi | D23/364 |

(Continued)

OTHER PUBLICATIONS

Firefly portable vaporizer, Nov. 27, 2013, <http://www.thefirefly.com/firefly-portable-vaporizer.html>.*

(Continued)

Primary Examiner — David Muller
Assistant Examiner — Nathan Johnston
(74) *Attorney, Agent, or Firm* — Steven R. Vosen

(57) **CLAIM**
We claim the ornamental design for a removable top for a portable vaporizer, as shown and described.

DESCRIPTION

FIG. 1 is an upper right rear perspective view of a removable top for a portable vaporizer showing our new design; FIG. 2 is a top plan view thereof; FIG. 3 is a left side elevation view thereof, the right side elevation view is a mirror image; FIG. 4 is a rear elevation view thereof; FIG. 5 is a front elevation view thereof; FIG. 6 is a lower right front perspective view thereof; and, FIG. 7 is a bottom plan view thereof. The broken lines are shown for environmental purposes only and form no part of the claimed design.

1 Claim, 4 Drawing Sheets

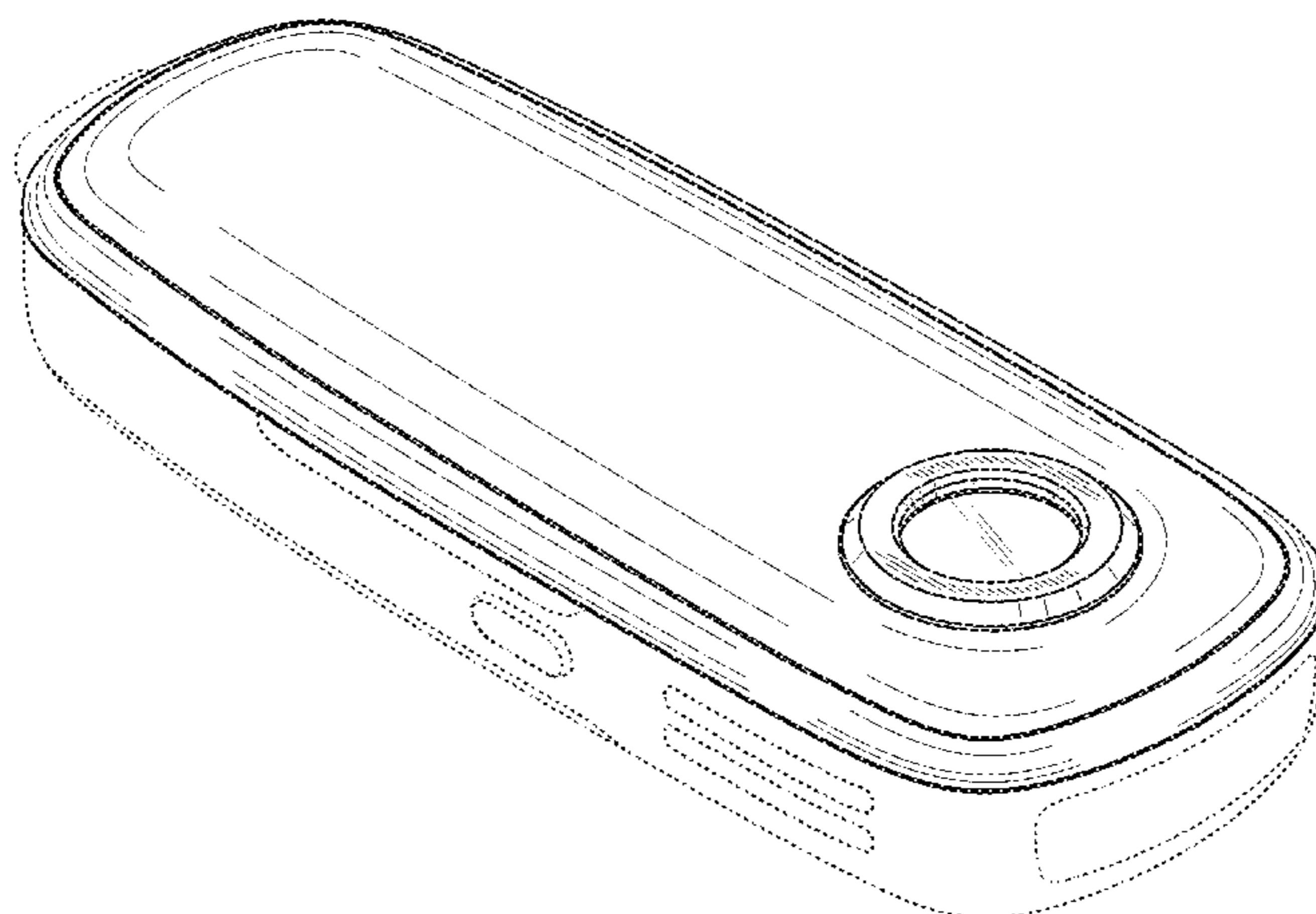

(56)

References Cited

U.S. PATENT DOCUMENTS

| | | | | |
|--------------|-----|---------|----------------------|---------|
| 7,905,236 | B2 | 3/2011 | Bryman et al. | |
| D640,649 | S * | 6/2011 | Luo | D14/125 |
| D640,650 | S * | 6/2011 | Luo | D14/125 |
| D656,230 | S | 3/2012 | Robinson et al. | |
| D657,857 | S * | 4/2012 | Choi | D23/364 |
| D662,578 | S * | 6/2012 | Blanking et al. | D23/366 |
| D664,636 | S | 7/2012 | Robinson et al. | |
| D677,774 | S * | 3/2013 | Postma | D23/360 |
| D689,999 | S * | 9/2013 | Viala | D23/366 |
| D716,428 | S * | 10/2014 | Farone et al. | D23/364 |
| 2004/0163643 | A1 | 8/2004 | Wesner | |
| 2007/0280652 | A1 | 12/2007 | Williams | |
| 2007/0283972 | A1 | 12/2007 | Monsees et al. | |
| 2008/0023003 | A1 | 1/2008 | Rosenthal | |

| | | | |
|--------------|----|---------|-----------------|
| 2008/0257367 | A1 | 10/2008 | Paterno et al. |
| 2009/0260641 | A1 | 10/2009 | Monsees et al. |
| 2009/0260642 | A1 | 10/2009 | Monsees et al. |
| 2009/0293888 | A1 | 12/2009 | Williams et al. |
| 2009/0293892 | A1 | 12/2009 | Williams et al. |
| 2010/0024834 | A1 | 2/2010 | Oglesby et al. |
| 2010/0163063 | A1 | 7/2010 | Fernando et al. |
| 2010/0322599 | A1 | 12/2010 | Landry |
| 2011/0073121 | A1 | 3/2011 | Levin et al. |

OTHER PUBLICATIONS

Robinson et al., co-pending Pending U.S. Appl. No. 13/167,968, filed Jun. 24, 2011.

Robinson et al., co-pending Pending Design U.S. Appl. No. 29/413,427, filed Feb. 15, 2012.

* cited by examiner

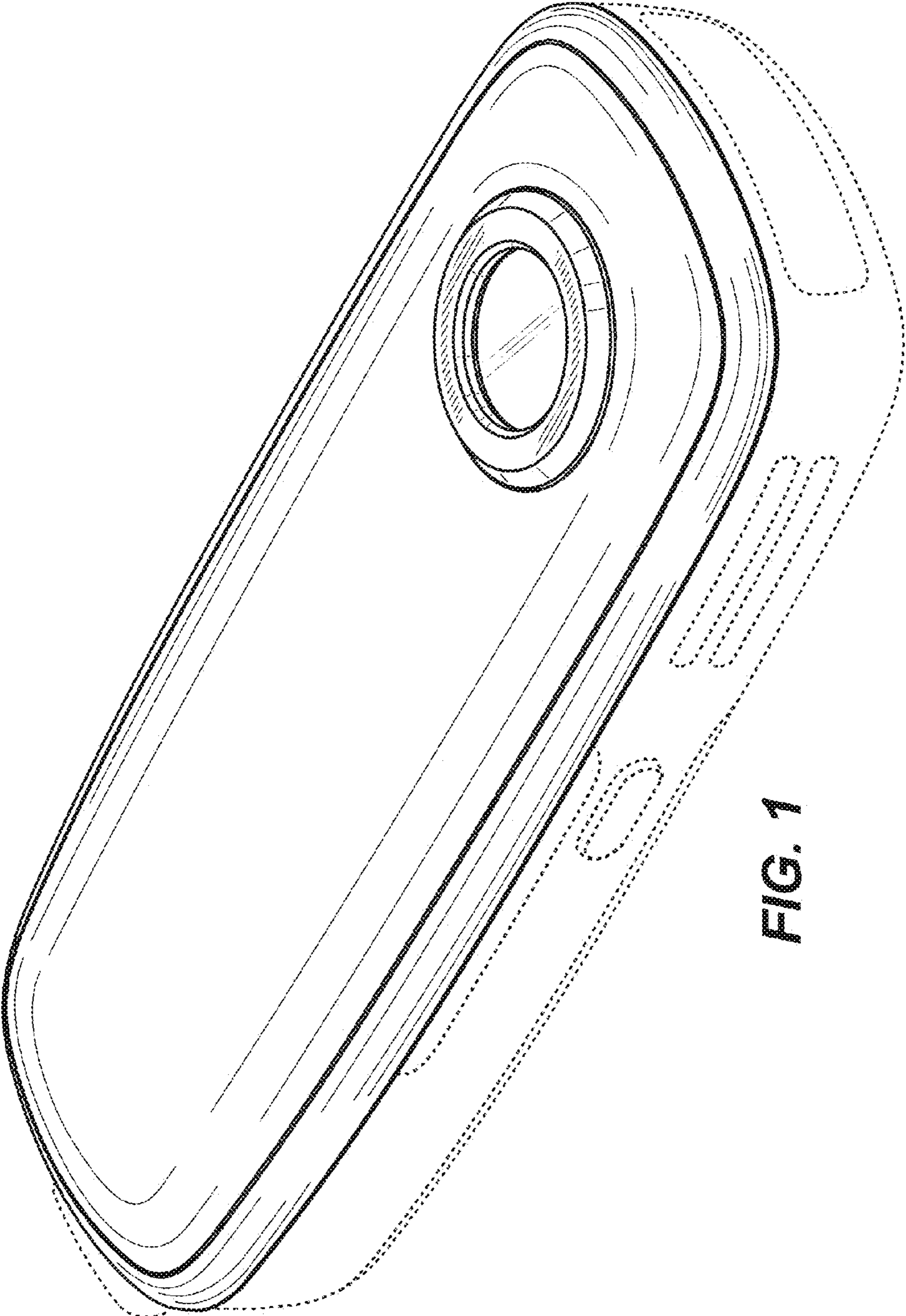

FIG. 1

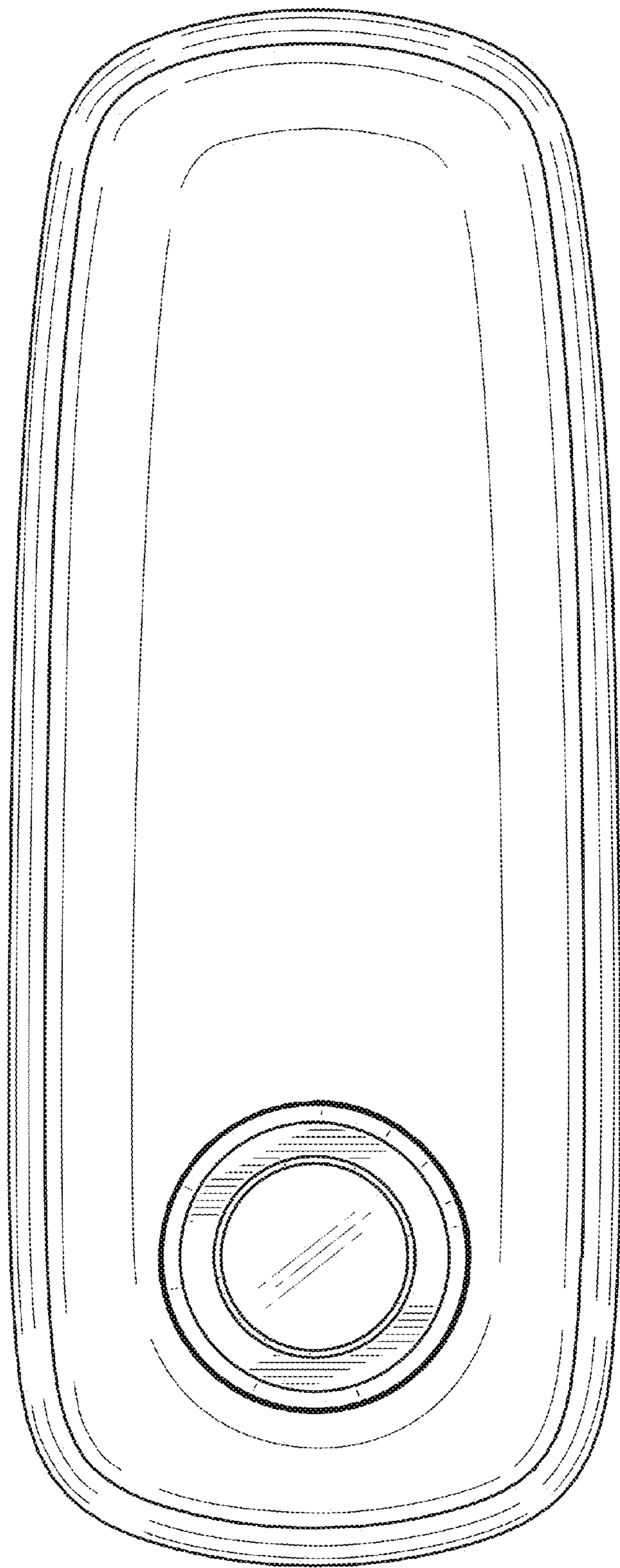

FIG. 2

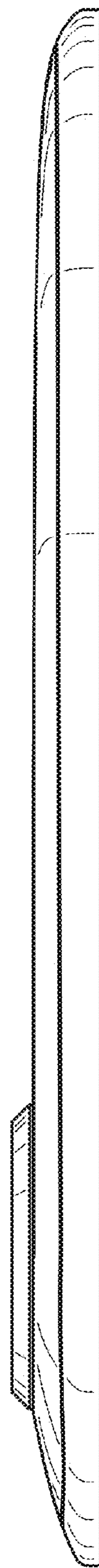

FIG. 3

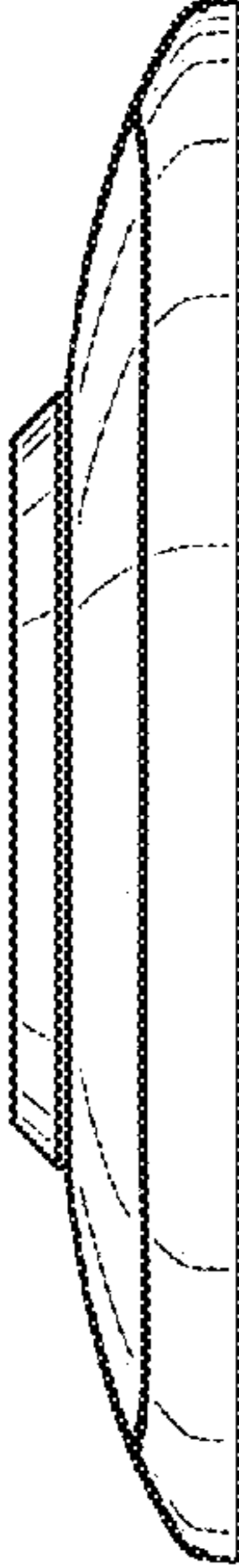

FIG. 4

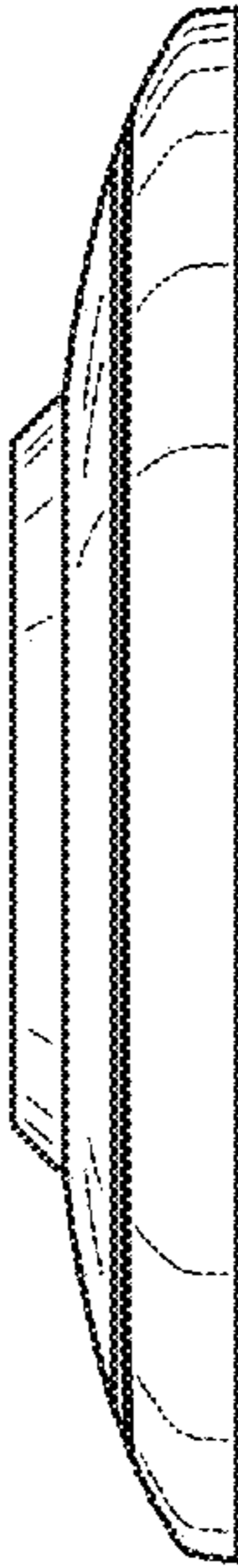

FIG. 5

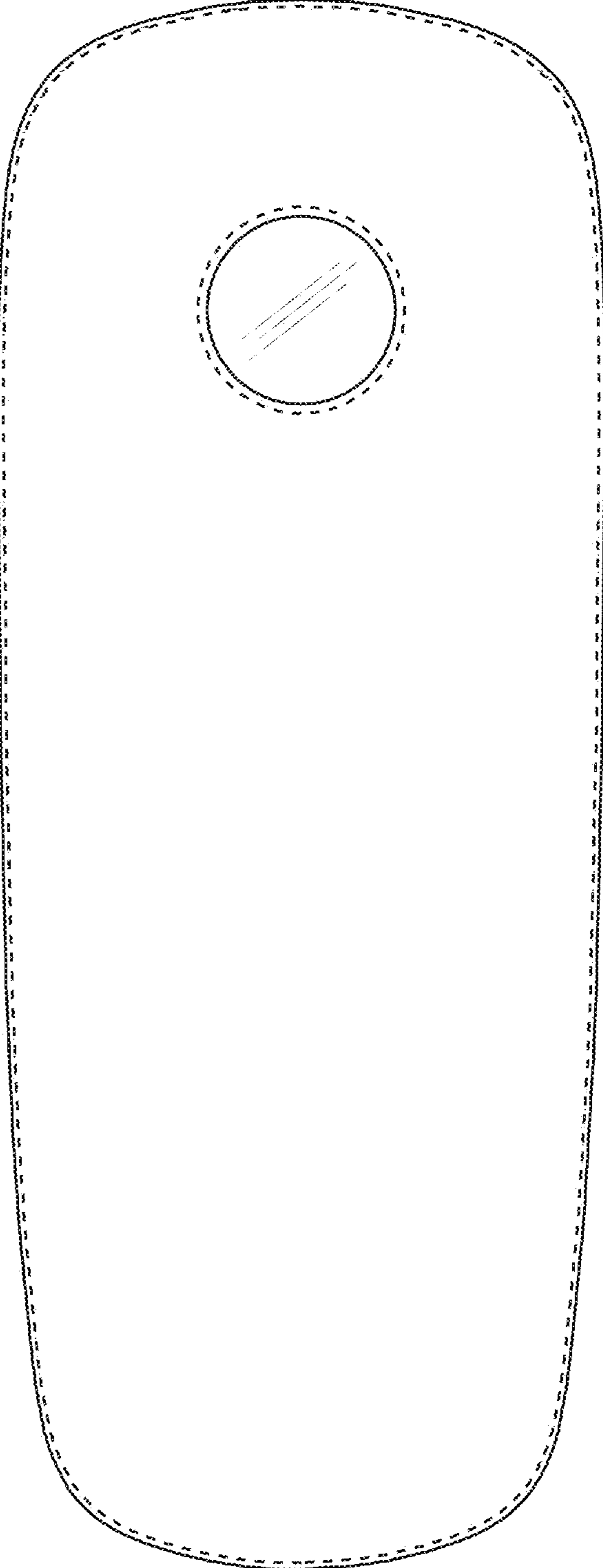

FIG. 7

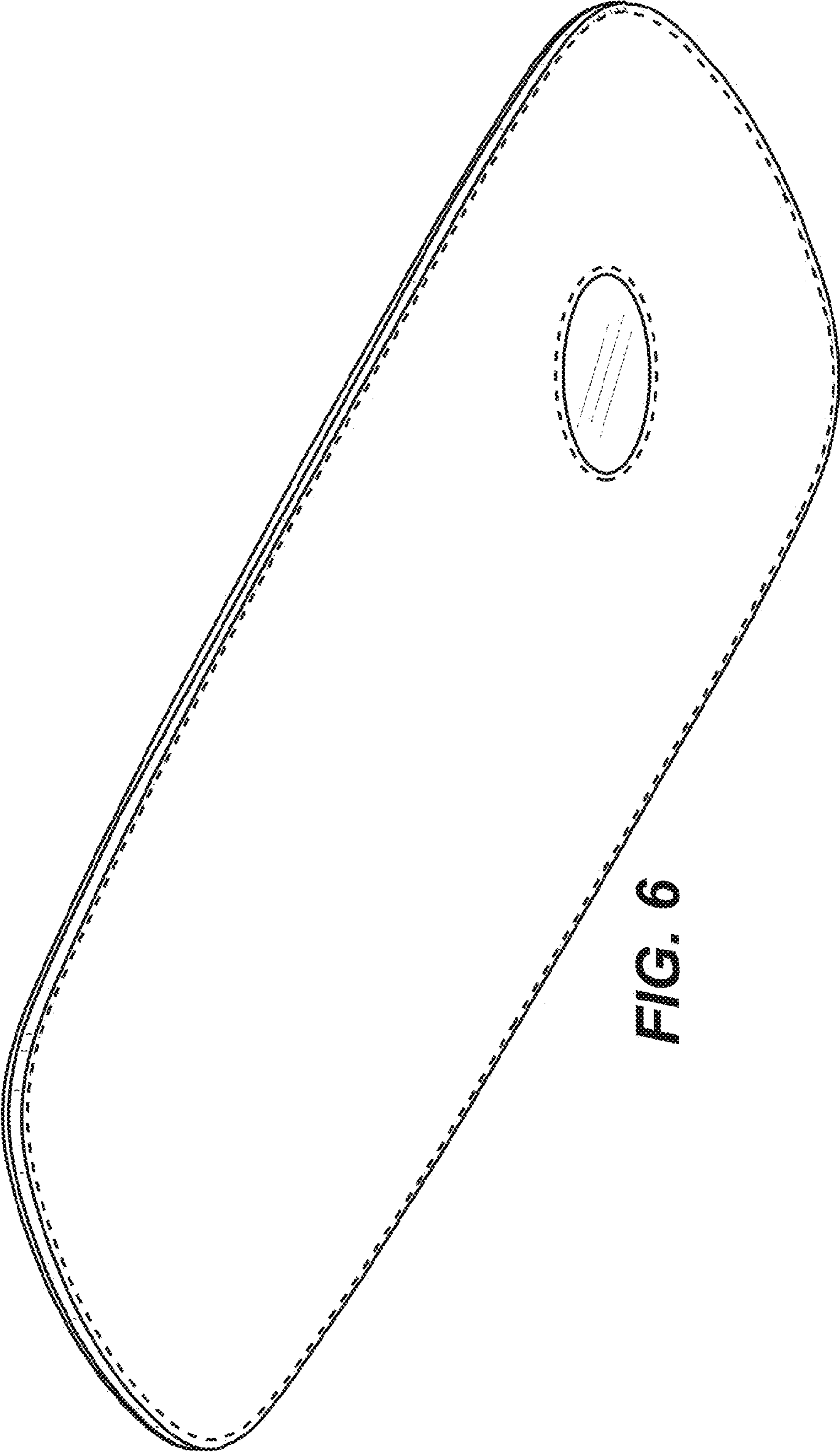

FIG. 6