



US00D742489S

(12) **United States Design Patent**
Iinuma et al.

(10) **Patent No.:** **US D742,489 S**
(45) **Date of Patent:** **** Nov. 3, 2015**

(54) **DRAIN PAN FOR HEAT EXCHANGER**

(71) Applicant: **MITSUBISHI ELECTRIC CORPORATION**, Tokyo (JP)

(72) Inventors: **Takahiro Iinuma**, Tokyo (JP); **Shoji Akamatsu**, Tokyo (JP)

(73) Assignee: **Mitsubishi Electric Corporation**, Tokyo (JP)

(**) Term: **14 Years**

(21) Appl. No.: **29/485,780**

(22) Filed: **Mar. 21, 2014**

(30) **Foreign Application Priority Data**

Sep. 24, 2013 (JP) 2013-021970
Sep. 24, 2013 (JP) 2013-021971

(51) **LOC (10) Cl.** **23-03**

(52) **U.S. Cl.**
USPC **D23/323**

(58) **Field of Classification Search**

USPC D23/385-395, 397, 370-373, 365, 351,
D23/354, 399-403, 421, 499, 259, 200, 314,
D23/323, 341, 333; 62/291, 288, 285;
29/890.035; 220/571; 413/1
CPC F24F 13/22; F24F 1/0007
See application file for complete search history.

(56) **References Cited**

U.S. PATENT DOCUMENTS

5,901,566 A * 5/1999 Macosko et al. 62/285
5,904,053 A * 5/1999 Polk et al. 62/285
5,987,909 A * 11/1999 Martin, Sr. 62/291
6,112,536 A * 9/2000 Hansen 62/285
6,691,884 B1 * 2/2004 Dwyer 220/4.03
7,418,827 B2 * 9/2008 Rios 62/285

(Continued)

Primary Examiner — T. Chase Nelson

Assistant Examiner — Ania Aman

(74) *Attorney, Agent, or Firm* — Studebaker & Brackett PC

(57) **CLAIM**

The ornamental design for a drain pan for heat exchanger, as shown and described.

DESCRIPTION

FIG. 1 is a front, bottom and left side perspective view of a drain pan for heat exchanger, showing our new design; FIG. 2 is a front, bottom and right side perspective view thereof; FIG. 3 is a front elevational view thereof; FIG. 4 is a rear elevational view thereof; FIG. 5 is a left side elevational view thereof; FIG. 6 is a right side elevational view thereof; FIG. 7 is a top plan view thereof; FIG. 8 is a bottom plan view thereof; FIG. 9 is a vertical cross-sectional view thereof; taken along line 9-9 of FIG. 3; FIG. 10 is a horizontal cross-sectional view thereof; taken along line 10-10 of FIG. 3; FIG. 11 is a front, bottom and left side perspective view of a drain pan for heat exchanger, showing a second embodiment of our new design; FIG. 12 is a front, bottom and right side perspective view thereof; FIG. 13 is a front elevational view thereof; FIG. 14 is a rear elevational view thereof; FIG. 15 is a left side elevational view thereof; FIG. 16 is a right side elevational view thereof; FIG. 17 is a top plan view thereof; FIG. 18 is a bottom plan view thereof; FIG. 19 is a vertical cross-sectional view thereof; taken along line 19-19 of FIG. 13; and, FIG. 20 is a horizontal cross-sectional view thereof; taken along line 20-20 of FIG. 13. The broken line shown in the drawings are for the purpose of illustrating portions of the article that form no part of the claimed design.

1 Claim, 16 Drawing Sheets

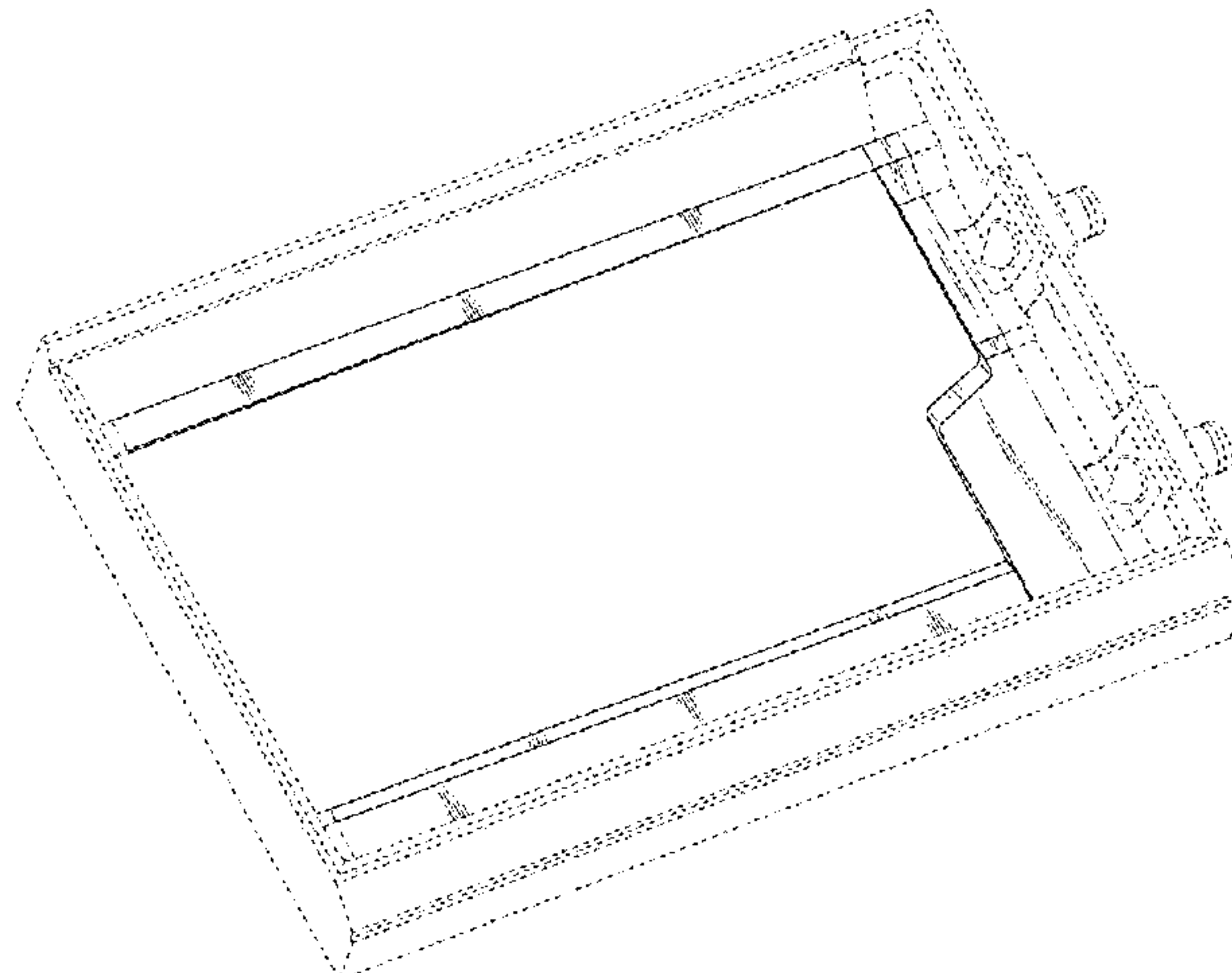

(56)

References Cited

U.S. PATENT DOCUMENTS

8,813,517	B2 *	8/2014	Lee et al.	62/274	2008/0047289	A1 *	2/2008	Patrick et al.	62/285
8,869,548	B2 *	10/2014	Piccione	62/291	2008/0245802	A1 *	10/2008	Gray	220/571
D720,447	S *	12/2014	Korda	D23/386	2010/0175408	A1 *	7/2010	Korda	62/291
2005/0109053	A1 *	5/2005	Eom et al.	62/285	2011/0265508	A1 *	11/2011	Piccione	62/291
						2012/0159981	A1 *	6/2012	Beck et al.	62/291

* cited by examiner

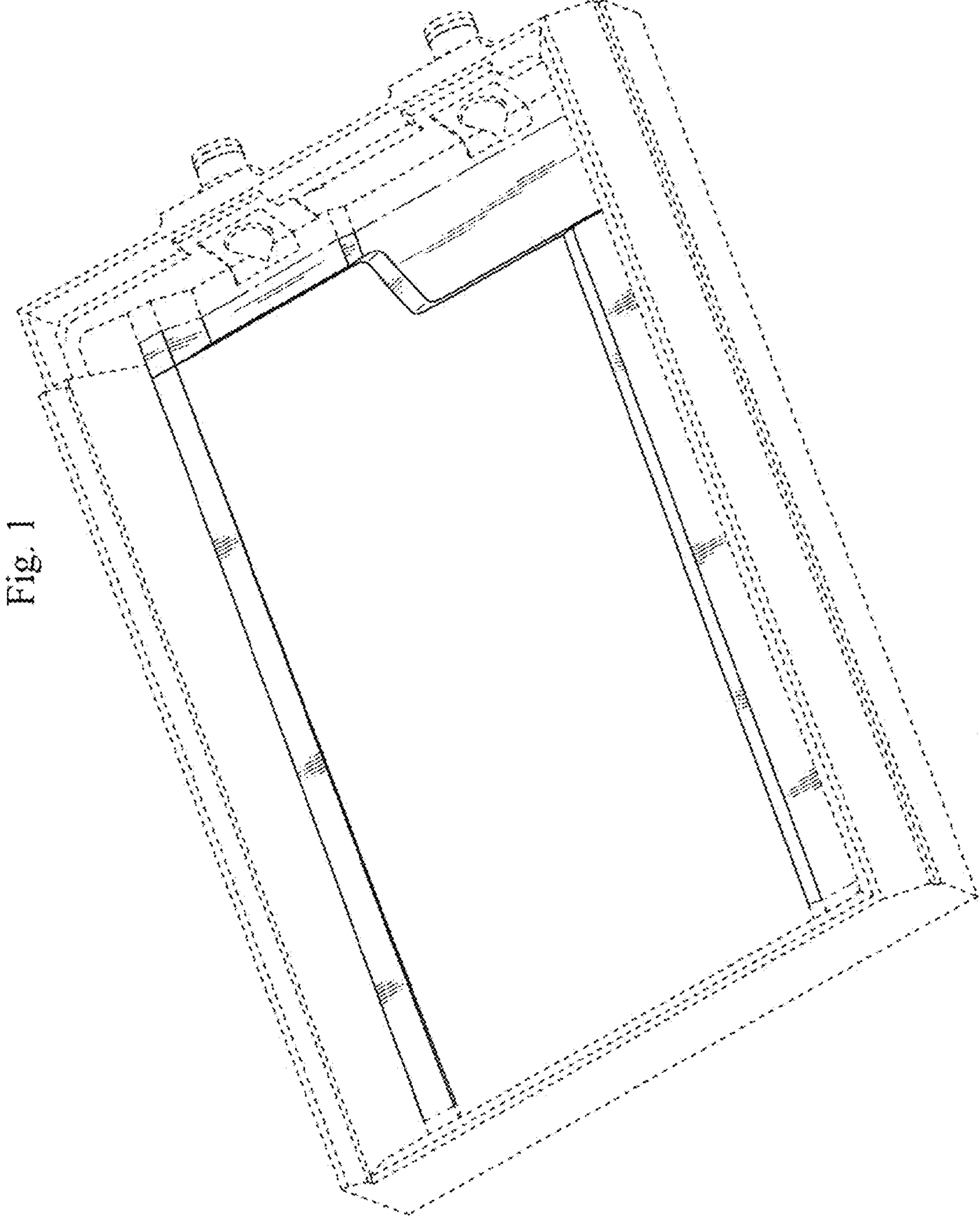

Fig. 1

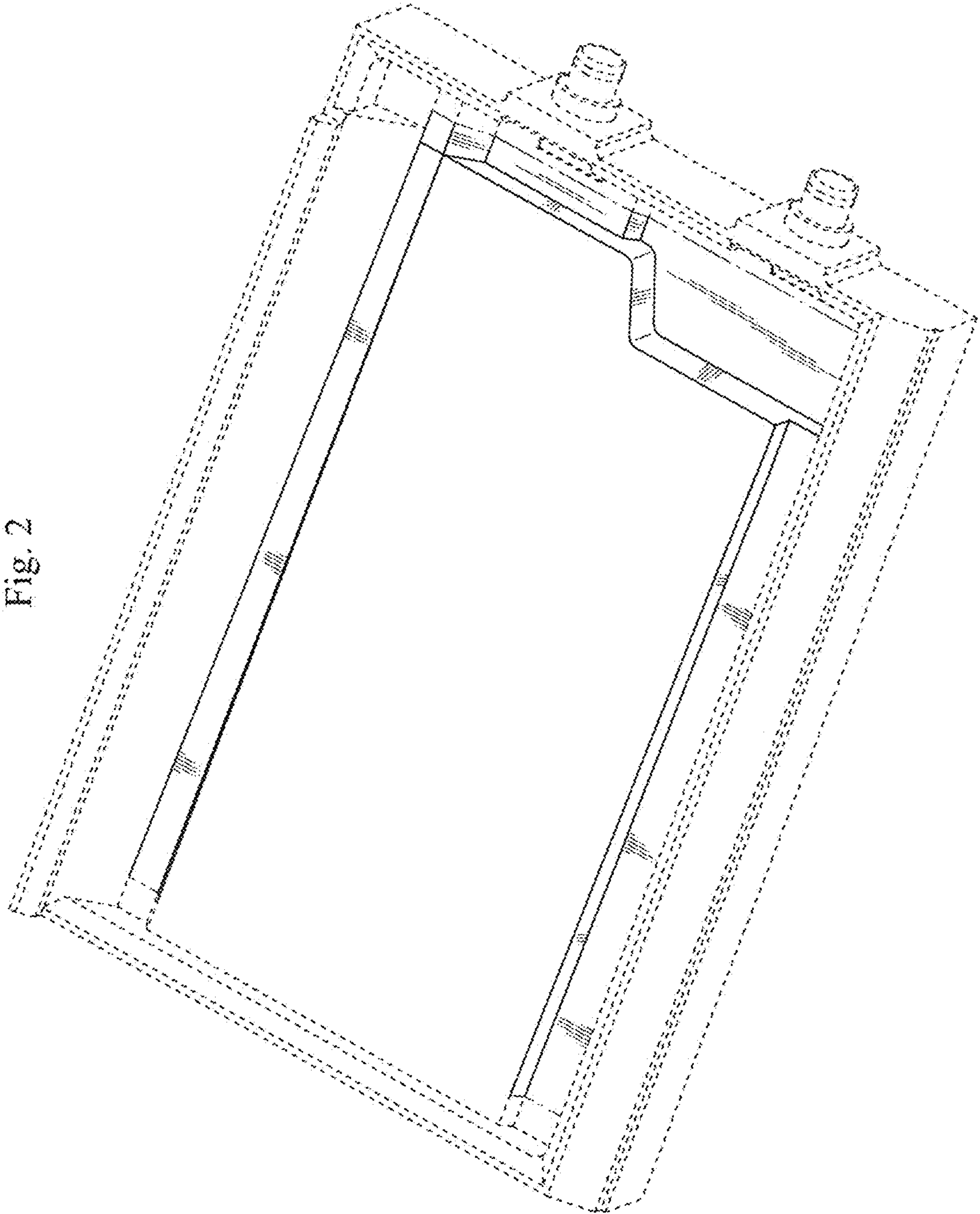

Fig. 2

Fig. 3

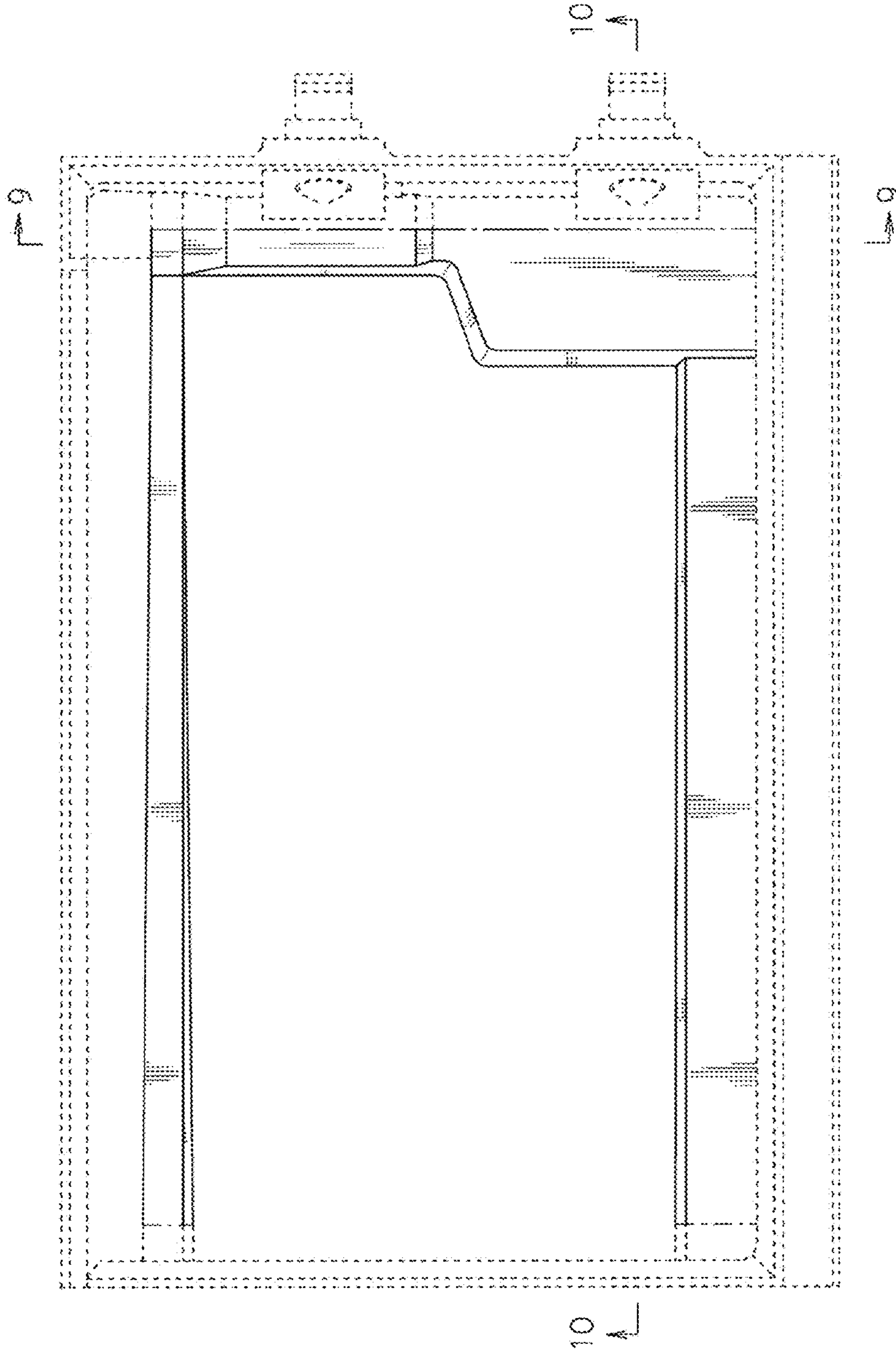

Fig. 4

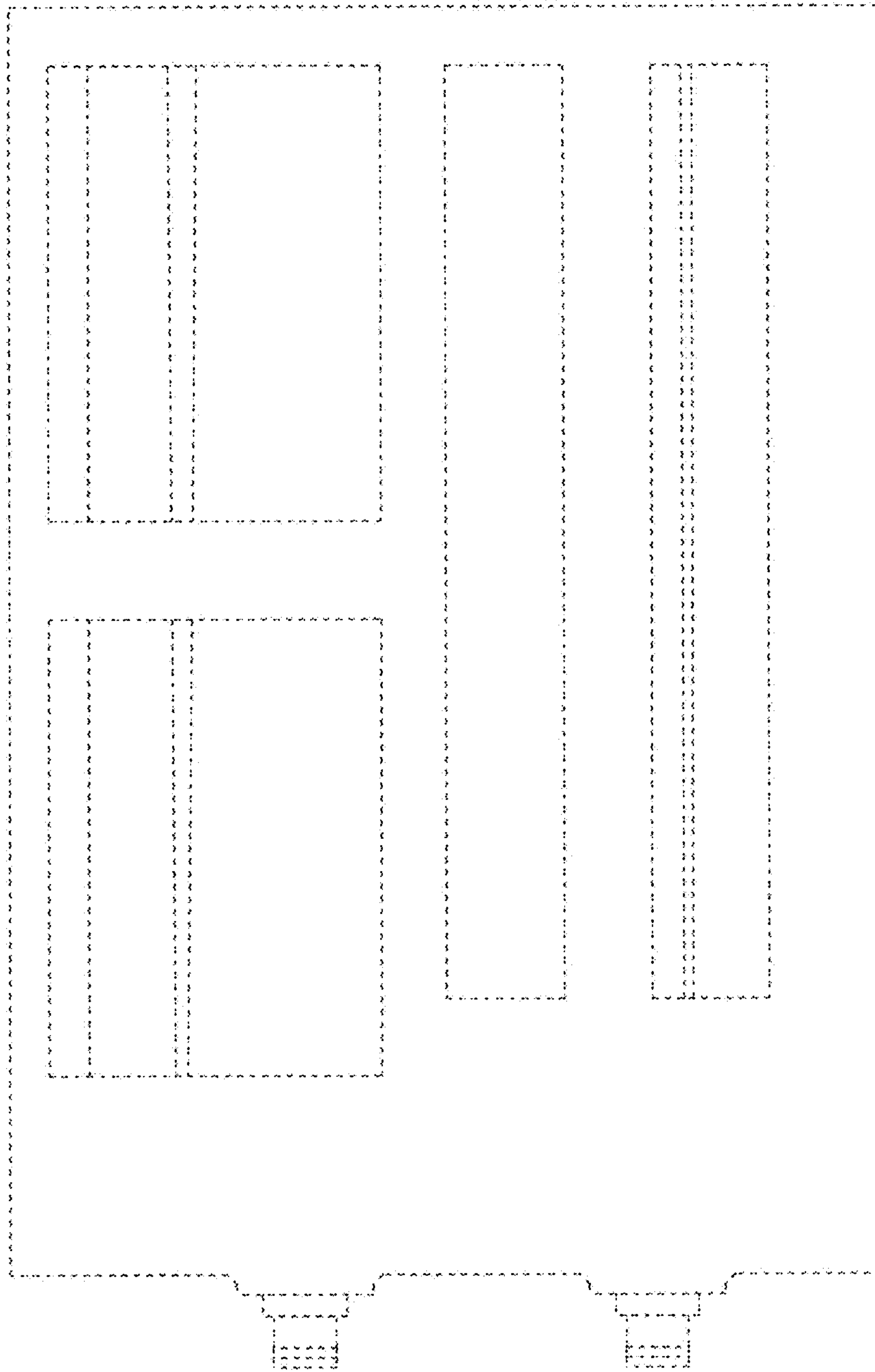

Fig. 6

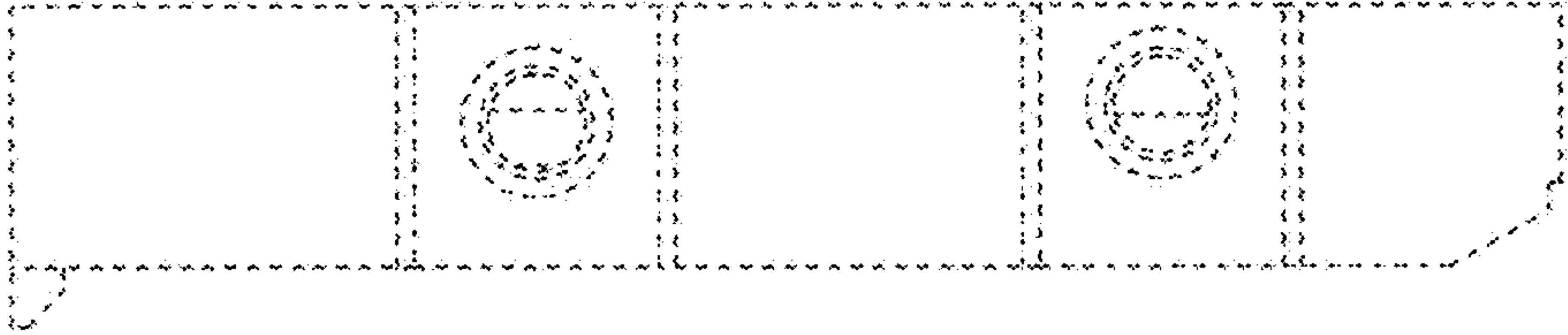

Fig. 5

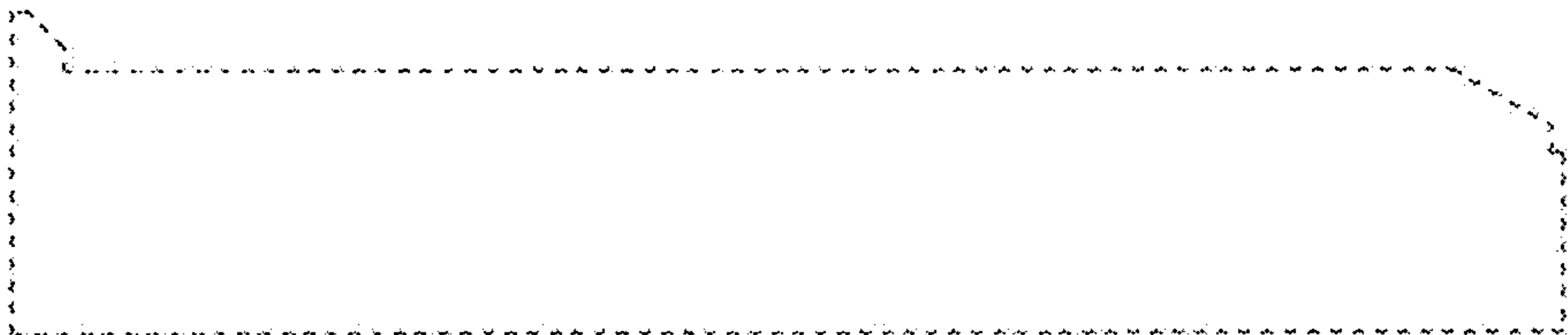

Fig. 7

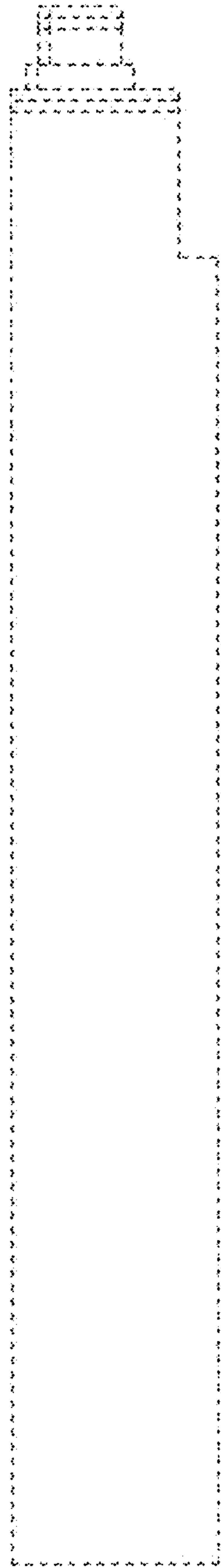

Fig. 8

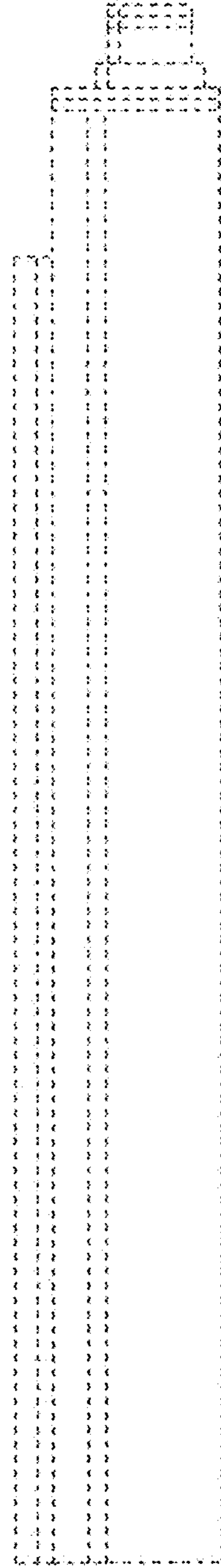

Fig. 9

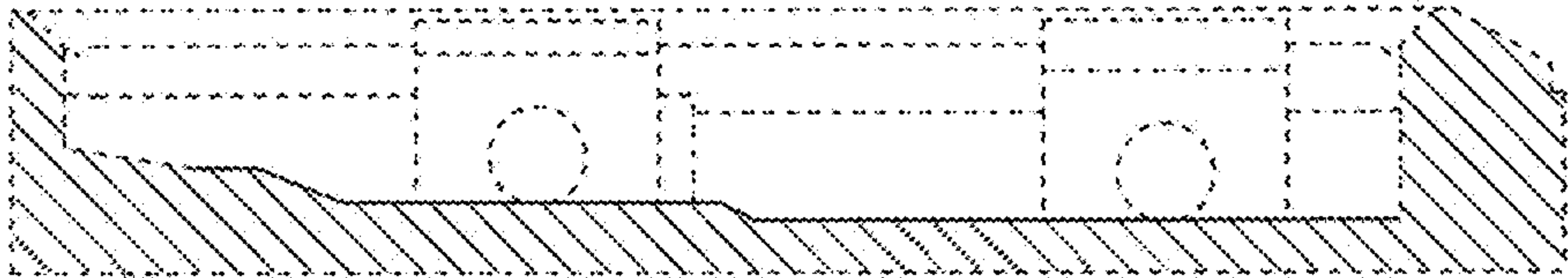

Fig. 10

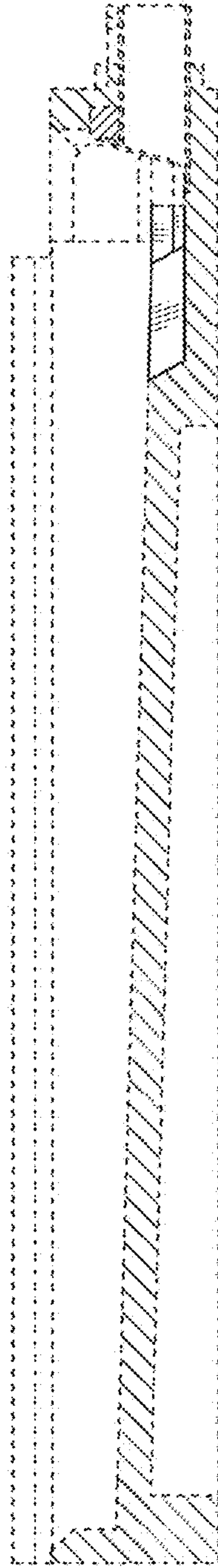
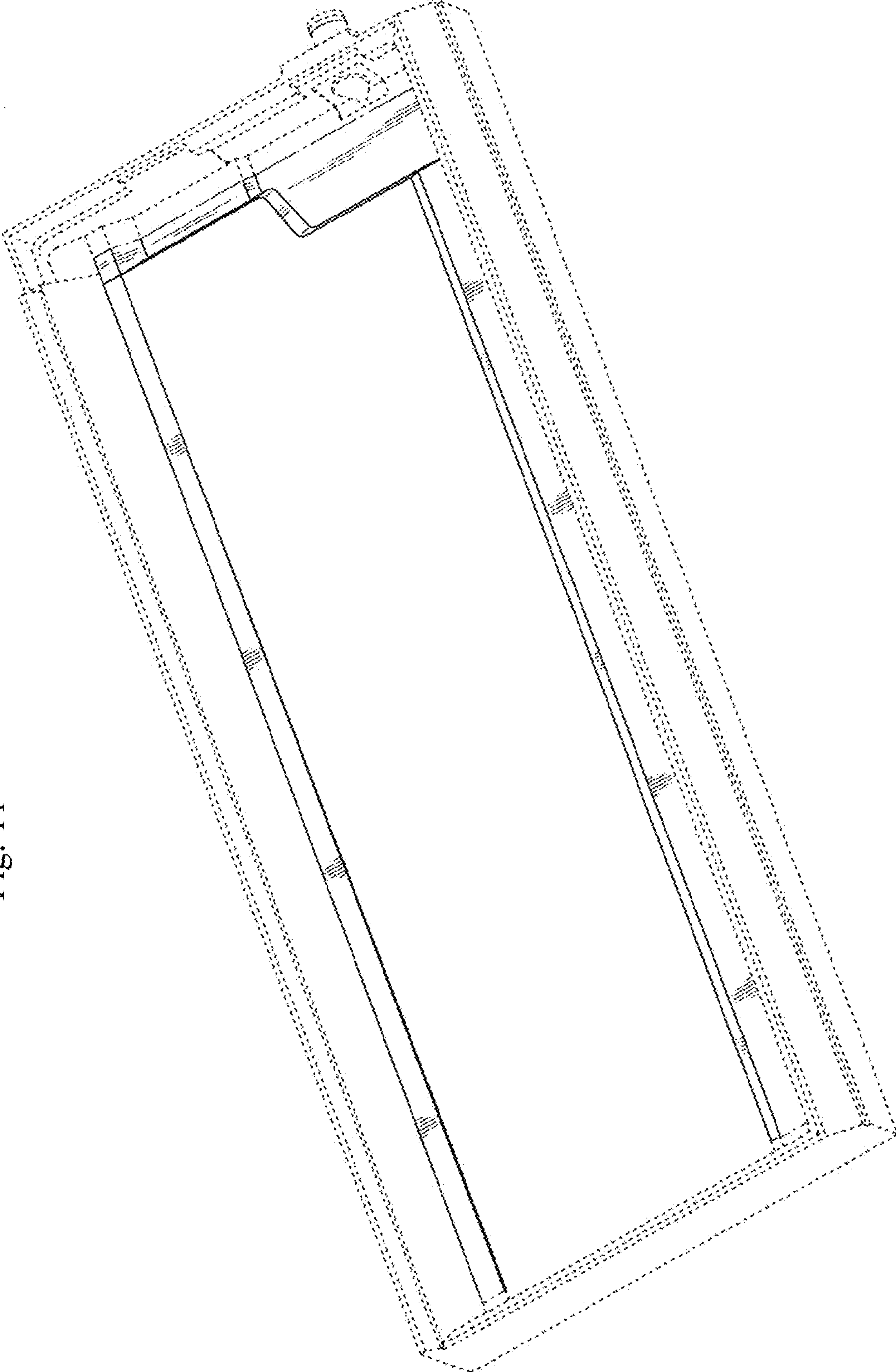

Fig. 11



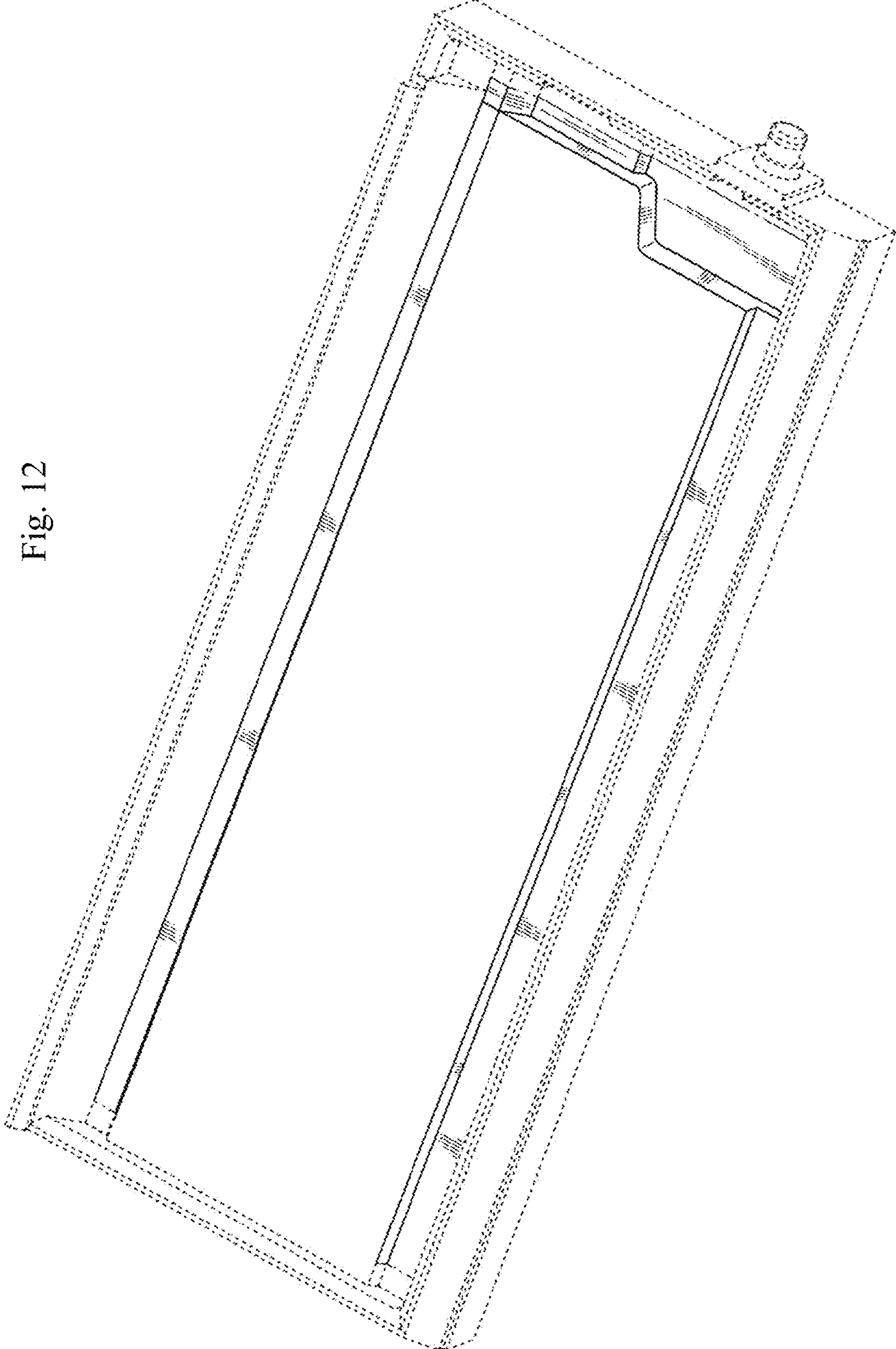

Fig. 12

Fig. 13

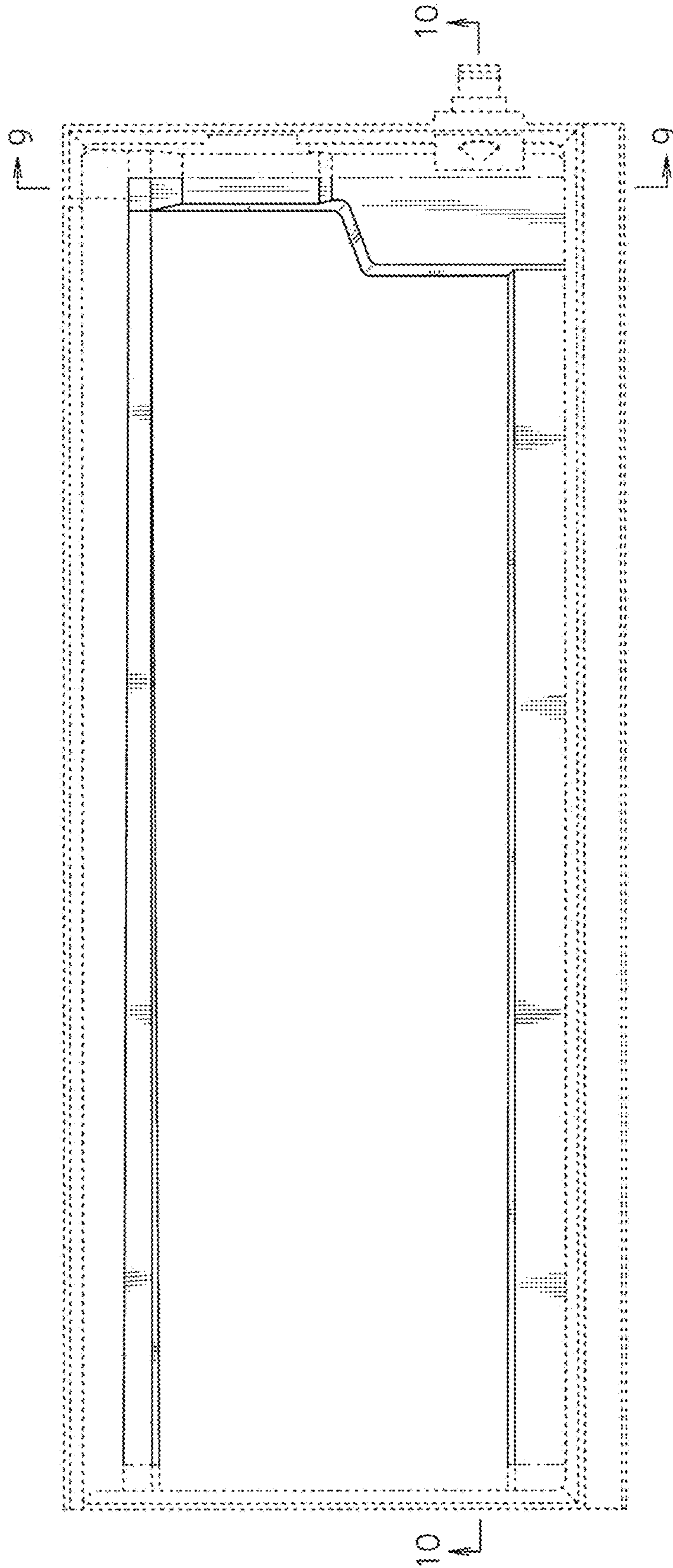

Fig. 14

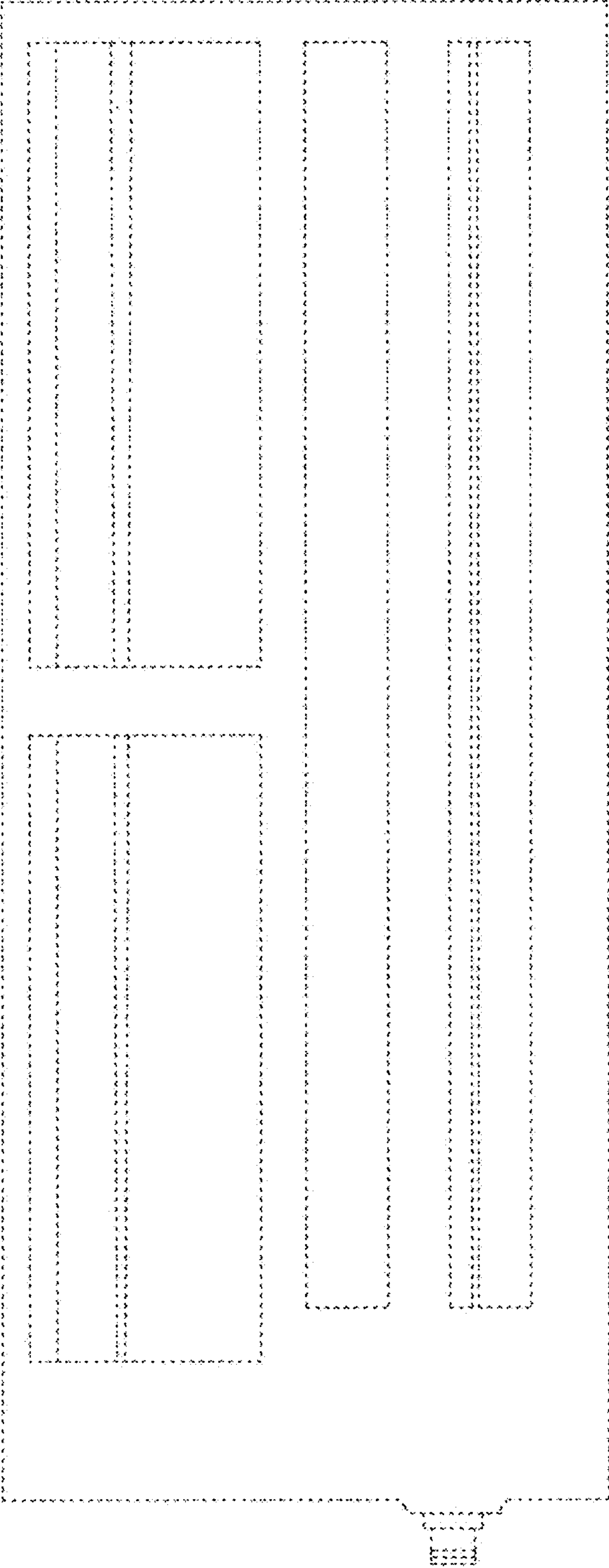

Fig. 16



Fig. 15

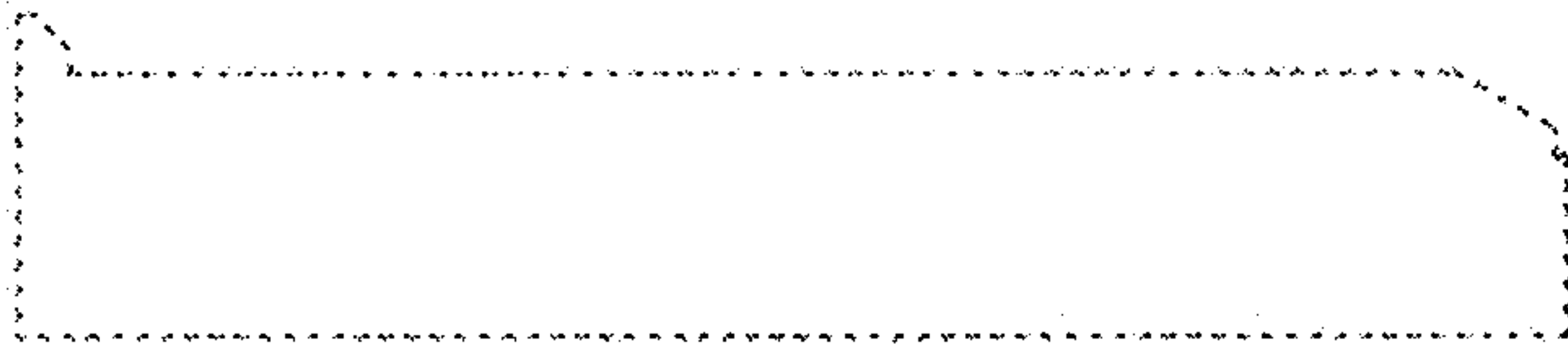

Fig. 17



Fig. 18

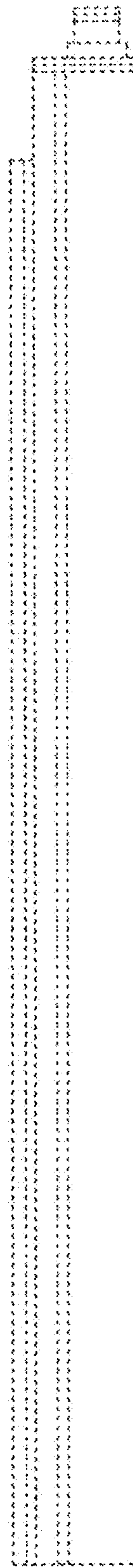

Fig. 19



Fig. 20

