



US00D742351S

(12) **United States Design Patent**
Chen et al.

(10) **Patent No.:** **US D742,351 S**
(45) **Date of Patent:** **** Nov. 3, 2015**

(54) **PORTABLE ELECTRONIC DEVICE**

(56) **References Cited**

(71) Applicant: **HTC Corporation**, Taoyuan, Taoyuan County (TW)

(72) Inventors: **Hung-Yu Chen**, Taoyuan (TW);
Meng-Sheng Chiang, Taoyuan (TW);
Yi-Shen Wang, Taoyuan (TW)

(73) Assignee: **HTC Corporation**, Taoyuan (TW)

(**) Term: **14 Years**

(21) Appl. No.: **29/479,039**

(22) Filed: **Jan. 10, 2014**

Related U.S. Application Data

(63) Continuation-in-part of application No. 29/460,891, filed on Jul. 16, 2013, now Pat. No. Des. 739,391, which is a continuation-in-part of application No. 29/454,474, filed on May 10, 2013, now Pat. No. Des. 732,498, which is a continuation-in-part of application No. 29/443,348, filed on Jan. 16, 2013.

(51) **LOC (10) Cl.** **14-03**

(52) **U.S. Cl.**
USPC **D14/138 G**

(58) **Field of Classification Search**
USPC D14/138 G, 138 AD, 341, 346, 345, D14/138 R, 496, 203.1, 203.3, 203.5, 203.7, D14/248, 218, 250; 455/575.1, 556.2, 455/575.3, 575.4; D21/517, 329; 379/433.01, 433.04; D10/65, 78; 361/679.3, 679.56; D13/168
CPC G06F 1/1626; H04M 1/72527; H04M 1/0266; H04M 1/185; H04M 1/0202-1/035
See application file for complete search history.

U.S. PATENT DOCUMENTS

D591,252	S *	4/2009	Kim	D14/138 AD
D615,057	S *	5/2010	Kim	D14/138 AB
D620,003	S *	7/2010	Chiang	D14/341
D622,248	S *	8/2010	Kwon	D14/138 AD
D627,782	S *	11/2010	Ichise	D14/346
D645,441	S *	9/2011	Choe	D14/138 G
D656,118	S *	3/2012	Kim	D14/138 G
D663,709	S *	7/2012	Kim	D14/138 AD
8,253,650	B2 *	8/2012	Sip	H04M 1/0247 345/1.1
D676,819	S *	2/2013	Choi	D14/138 G
D677,233	S *	3/2013	Mauritzson	D14/138 G
D677,234	S *	3/2013	Hirano	D14/138 G
D683,325	S *	5/2013	Sugiyama	D14/138 G
D683,713	S *	6/2013	Hofer	D14/138 G
D702,203	S *	4/2014	Son	D14/138 G
D716,250	S *	10/2014	Becker	D14/138 G
D719,150	S *	12/2014	Daniel	D14/341
8,914,060	B2 *	12/2014	Kim	H01Q 1/084 455/550.1
8,922,996	B2 *	12/2014	Yeh	H04M 1/0202 361/679.3
D721,667	S *	1/2015	Chuang	D14/138 G
D724,572	S *	3/2015	Wildner	D14/250
D730,310	S *	5/2015	Hundt	D14/138 G
D731,481	S *	6/2015	Akana	D14/341
D732,498	S *	6/2015	Huang	D14/138 G
D733,693	S *	7/2015	Wang	D14/248
2009/0303199	A1 *	12/2009	Cho	G06F 3/04883 345/173
2014/0085777	A1 *	3/2014	Yeh	H04M 1/0202 361/679.01
2014/0284096	A1 *	9/2014	Wu	H05K 5/04 174/520

FOREIGN PATENT DOCUMENTS

TW	D149836	S	10/2012
TW	D153730	S	5/2013
TW	D156142	S1	9/2013
TW	D157832	S	12/2013
TW	D158992	S	2/2014
TW	D159657	S	4/2014

OTHER PUBLICATIONS

HTC One (M8), announced Mar. 2014, [online], [site visited 03/28/2015]. Available from Internet, <URL: [http://www.gsmarena.com/htc_one_\(m8\)-6074.php](http://www.gsmarena.com/htc_one_(m8)-6074.php)>.*

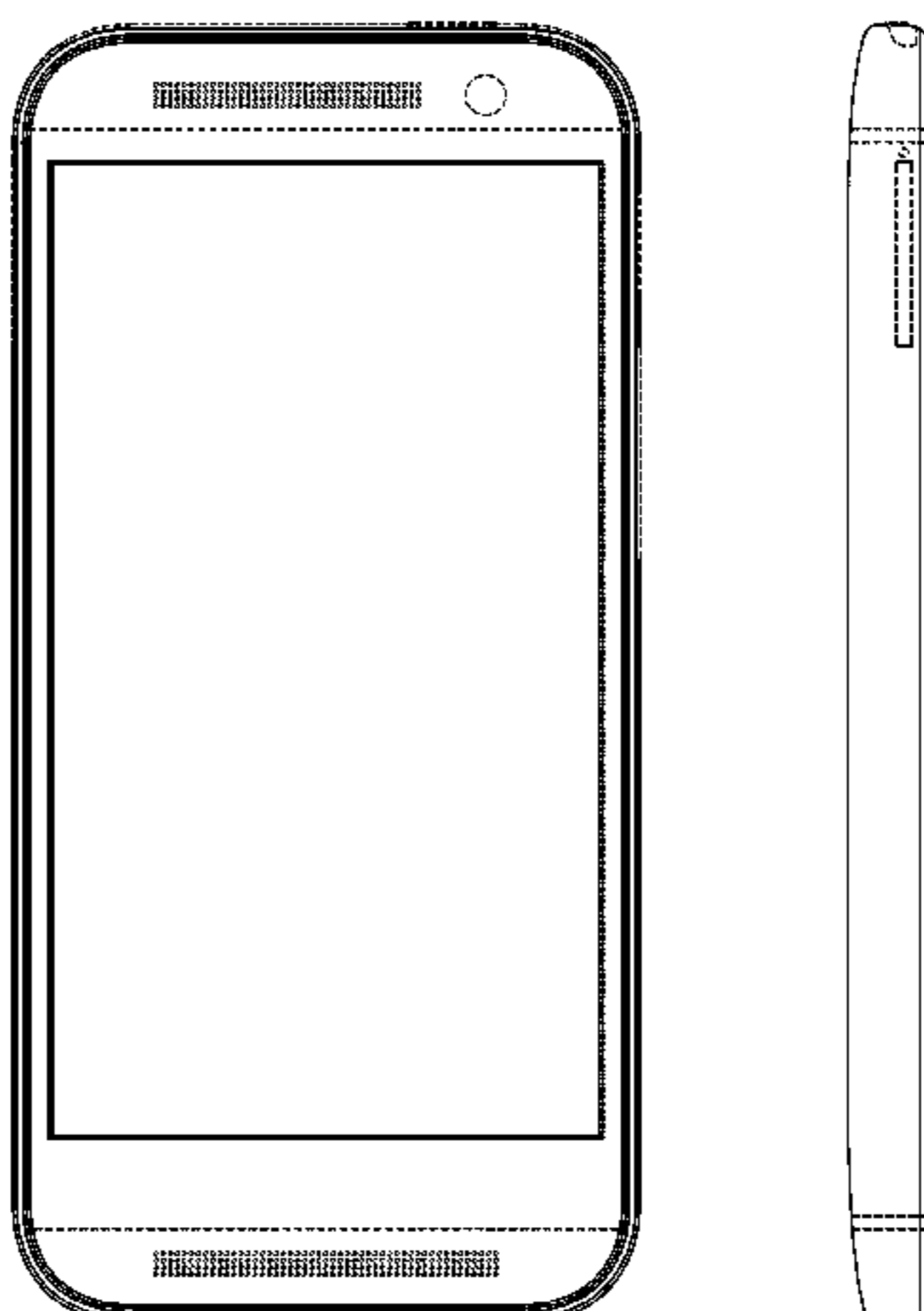

HTC One (M8), announced May 2015, [online], [site visited 03/28/2015]. Available from Internet, <URL: http://www.gsmarena.com/htc_one_m8s-7165.php>.*

HTC One mini 2, announced May 2014, [online], [site visited 03/28/2015]. Available from Internet, <URL: http://www.gsmarena.com/htc_one_mini_2-6345.php>.*

HTC One, announced Mar. 2013, [online], [site visited Mar. 28, 2015]. Available from Internet, <URL: http://www.gsmarena.com/htc_one-5313.php>.*

Lava Iris 400s, announced Aug. 2014, [online], [site visited 03/28/2015]. Available from Internet, <URL: http://www.gsmarena.com/lava_iris_400s-6770.php>.*

Spice Smart Flo 359 (Mi-359), announced Aug. 2014, [online], [site visited 03/28/2015]. Available from Internet, <URL: [http://www.gsmarena.com/spice_smart_flo_359_\(mi_359\)-7000.php](http://www.gsmarena.com/spice_smart_flo_359_(mi_359)-7000.php)>.*

Celkon AR40, announced Dec. 2013, [online], [site visited 03/28/2015]. Available from Internet, <URL: http://www.gsmarena.com/celkon_ar40-5916.php>.*

HTC One (M8 Eye) announced Oct. 2014, [online], [site visited 03/28/2015]. Available from Internet, <URL: [http://www.gsmarena.com/htc_one_\(m8_eye\)-pictures-6713.php](http://www.gsmarena.com/htc_one_(m8_eye)-pictures-6713.php)>.*

* cited by examiner

Primary Examiner — Jeffrey D Asch
(74) *Attorney, Agent, or Firm* — Birch, Stewart, Kolasch & Birch, LLP

(57) **CLAIM**

The ornamental design for a portable electronic device, as shown and described.

DESCRIPTION

FIG. 1 is a front perspective view of a first embodiment of a portable electronic device in accordance with our new design; FIG. 2 is a front view thereof;

FIG. 3 is a rear view thereof;
FIG. 4 is a left side view thereof;
FIG. 5 is a right side view thereof;
FIG. 6 is a top plan view thereof;
FIG. 7 is a bottom plan view thereof;
FIG. 8 is a rear perspective view thereof;
FIG. 9 is a front perspective view of a second embodiment of a portable electronic device in accordance with our new design;
FIG. 10 is a front view thereof;
FIG. 11 is a rear view thereof;
FIG. 12 is a left side view thereof;
FIG. 13 is a right side view thereof;
FIG. 14 is a top plan view thereof;
FIG. 15 is a bottom plan view thereof;
FIG. 16 is a rear perspective view thereof;
FIG. 17 is a front perspective view of a third embodiment of a portable electronic device in accordance with our new design;
FIG. 18 is a front view thereof;
FIG. 19 is a rear view thereof;
FIG. 20 is a left side view thereof;
FIG. 21 is a right side view thereof;
FIG. 22 is a top plan view thereof;
FIG. 23 is a bottom plan view thereof; and,
FIG. 24 is a rear perspective view thereof.

The broken lines shown in the figures that are adjacent to the surfaces that are included in the claim represent boundaries in the second and third embodiments. Broken line features shown within broken line boundaries show environment that forms not part of the embodiment in which they are shown. The broken lines and the non-shaded regions within form no part of the embodiment in which they are shown.

1 Claim, 21 Drawing Sheets

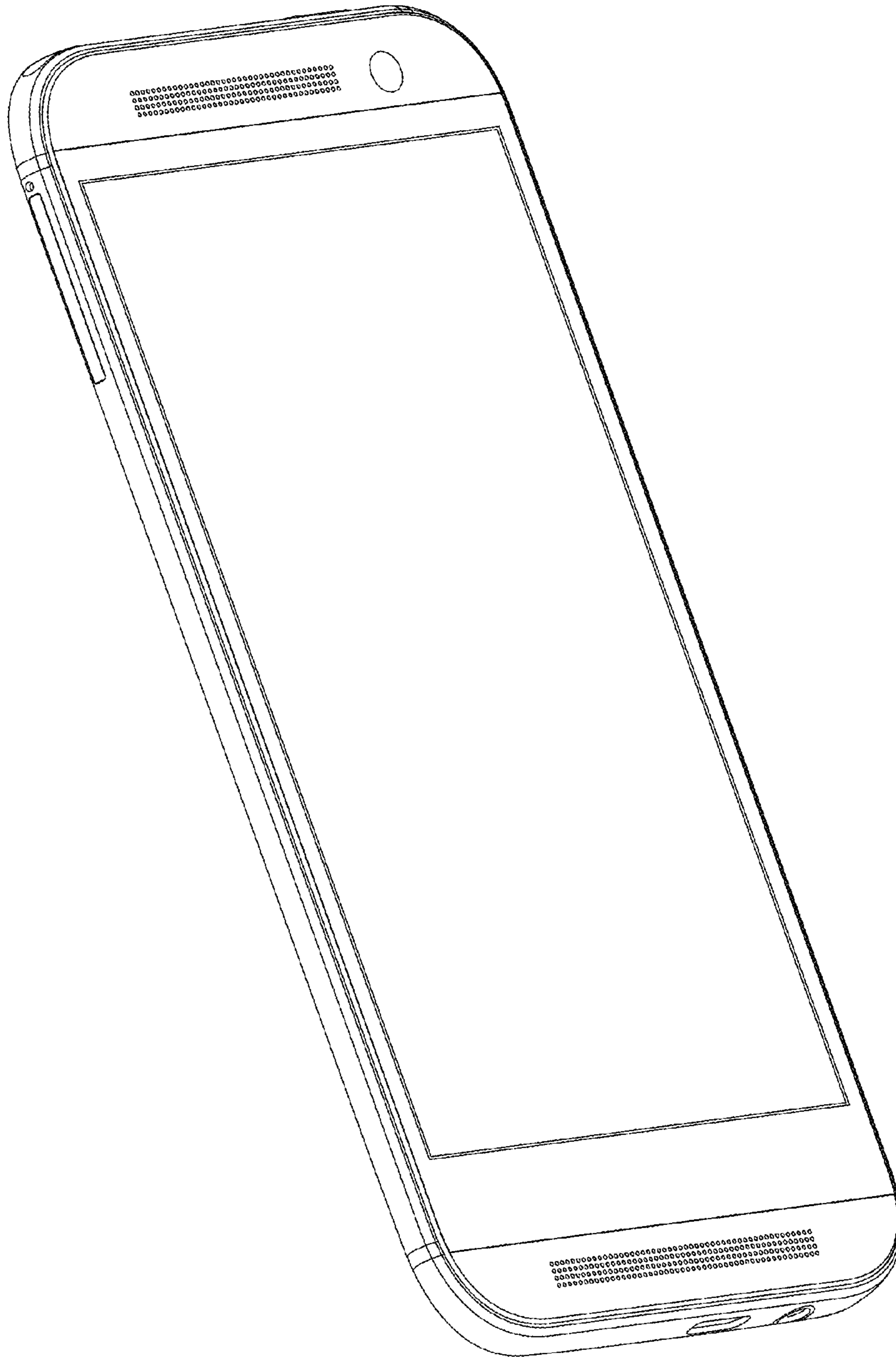

FIG. 1

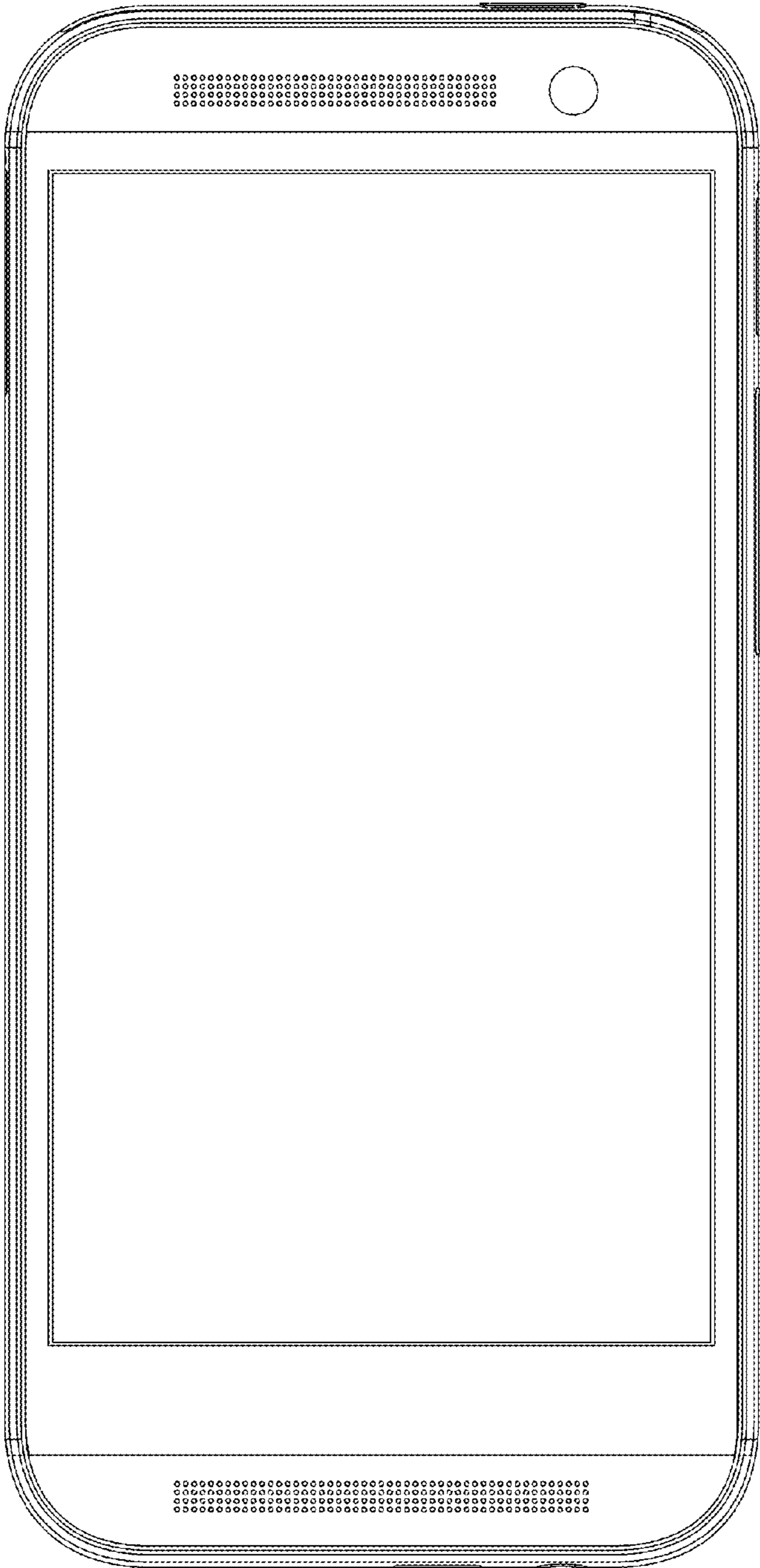

FIG. 2



FIG. 3

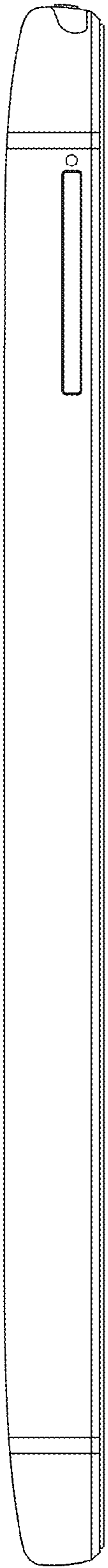

FIG. 4

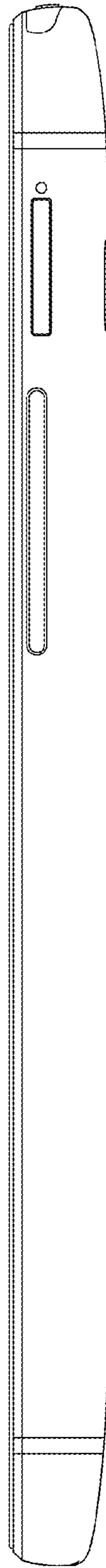

FIG. 5

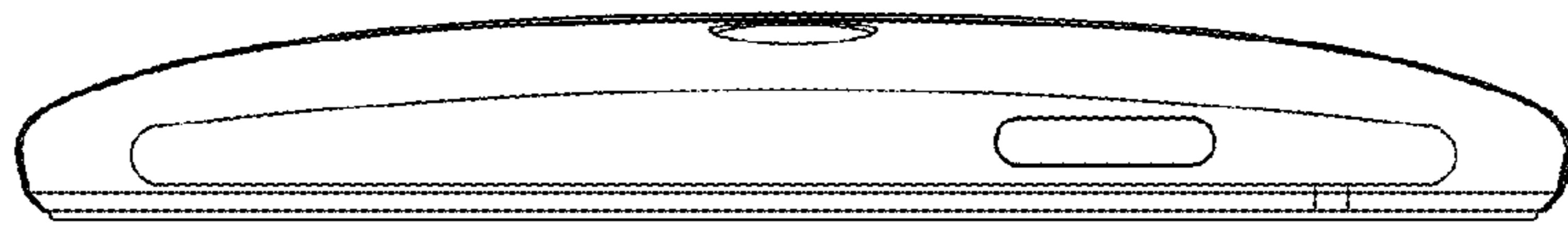

FIG. 6

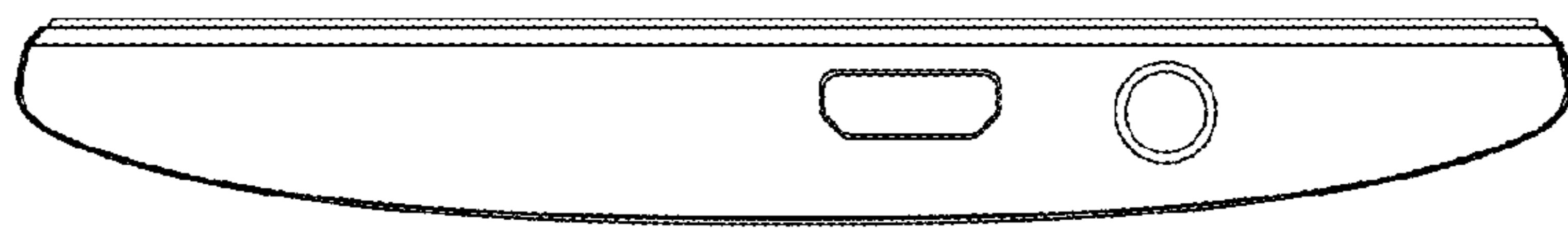

FIG. 7

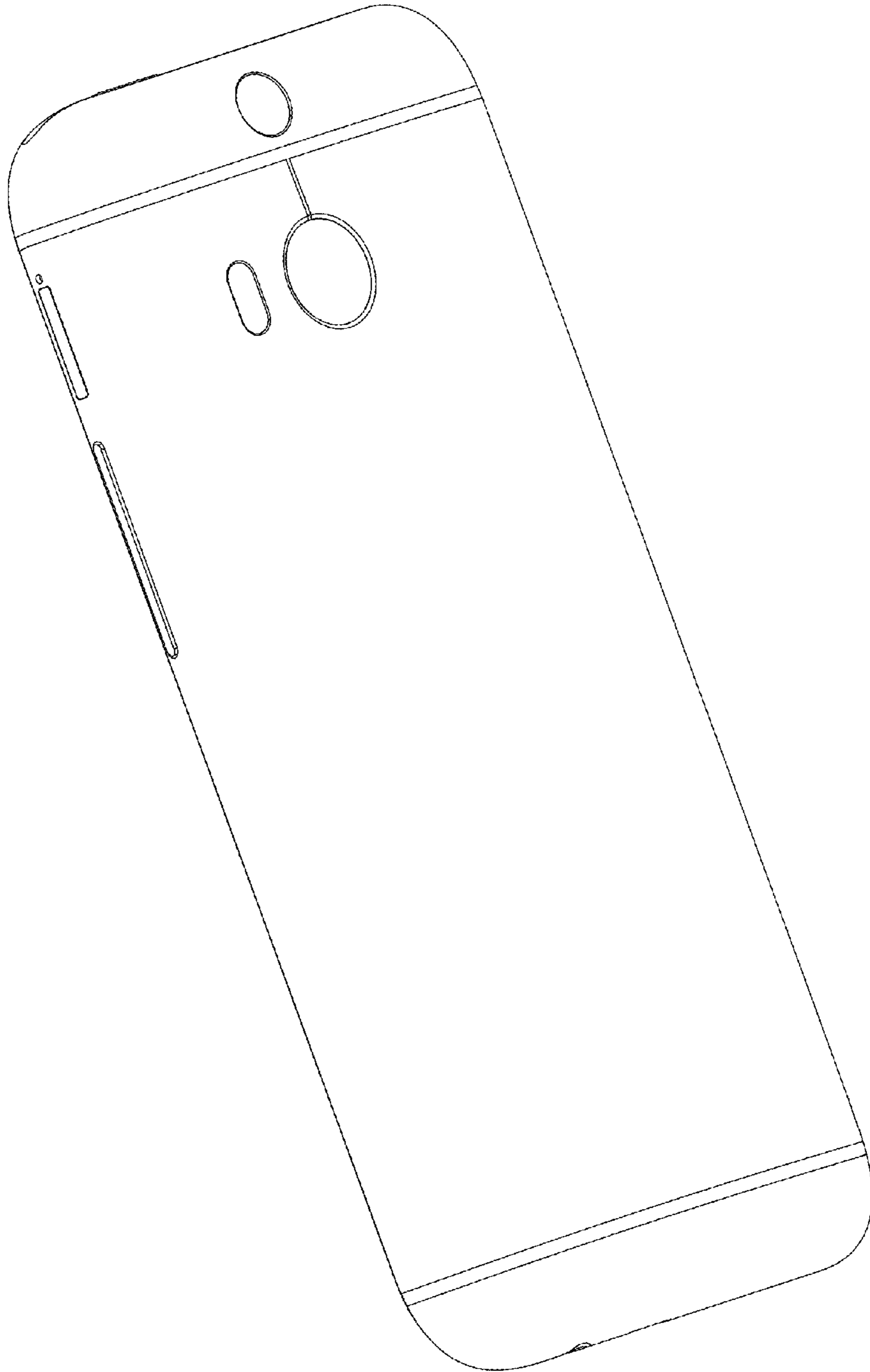

FIG. 8

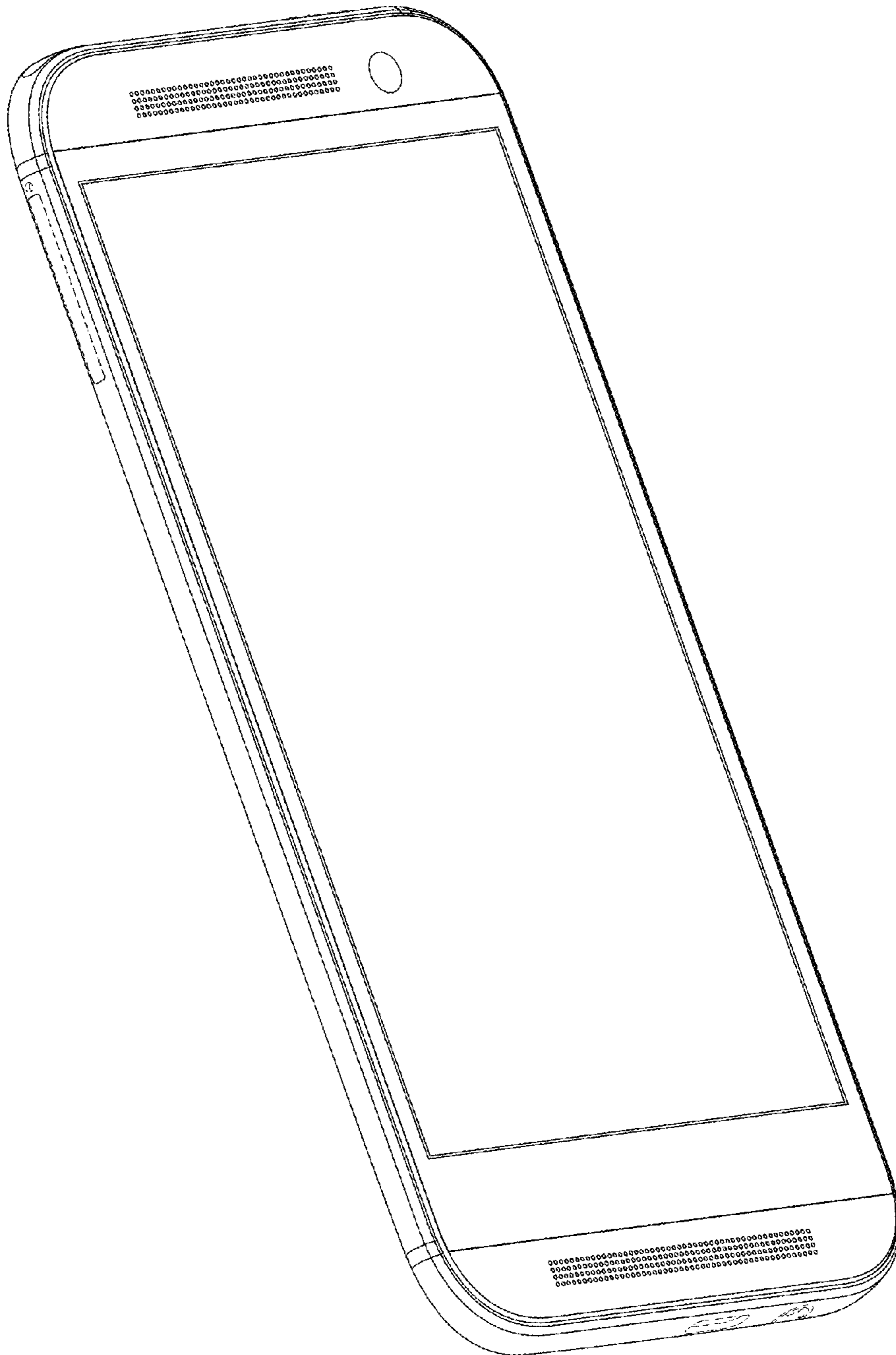

FIG. 9

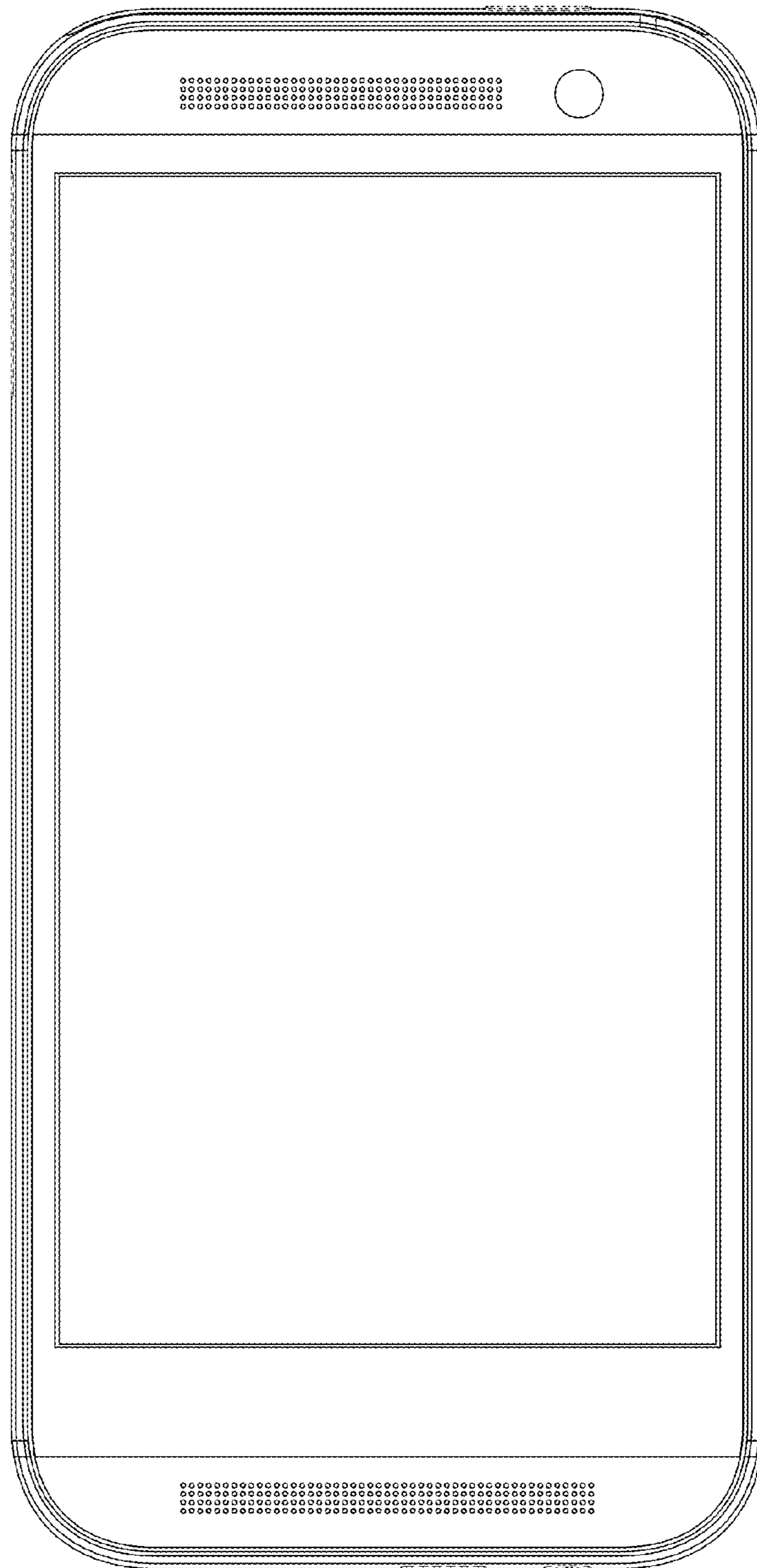

FIG. 10

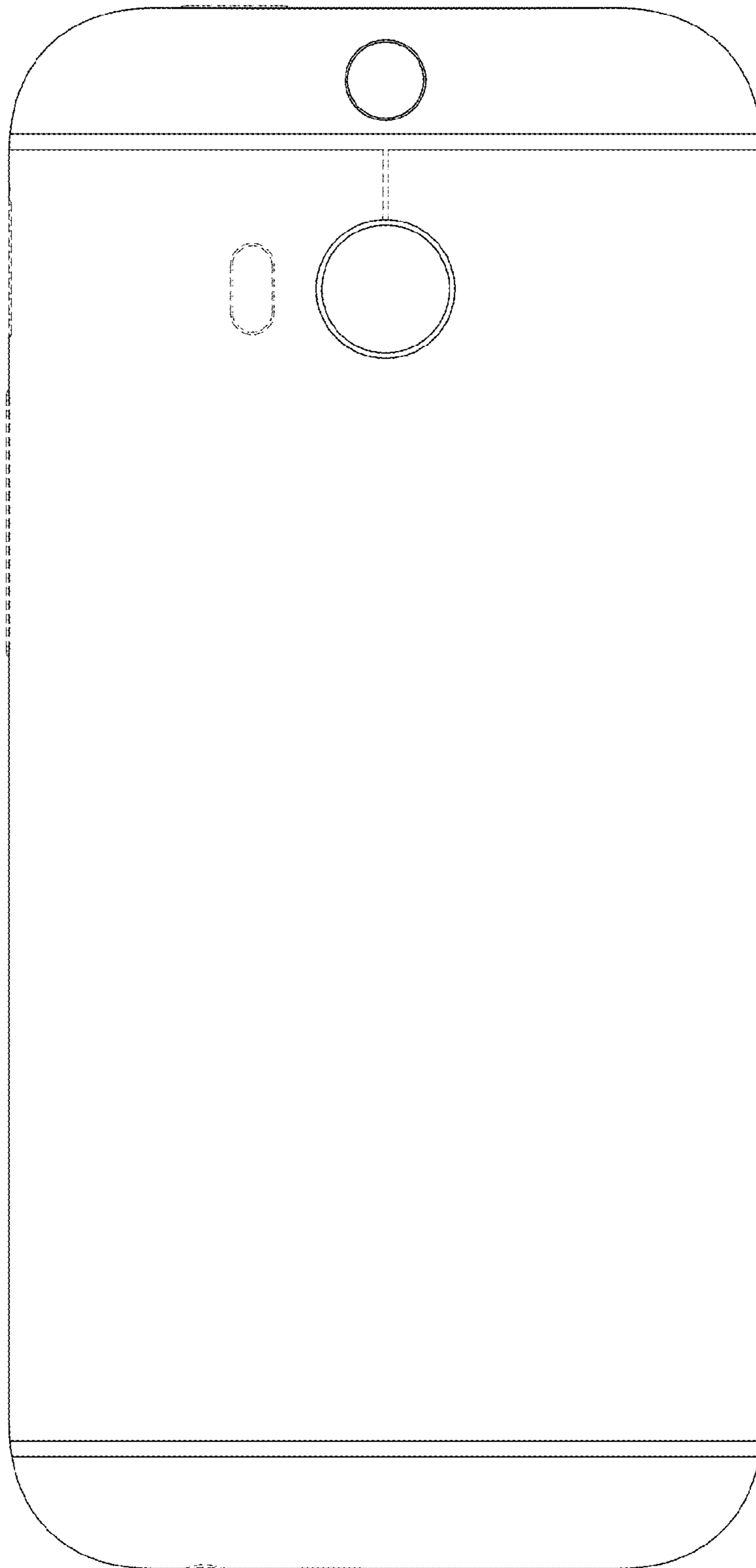

FIG. 11



FIG. 12

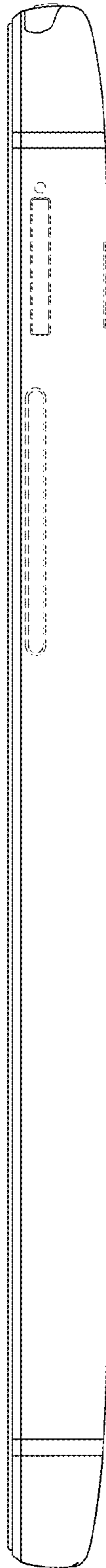

FIG. 13

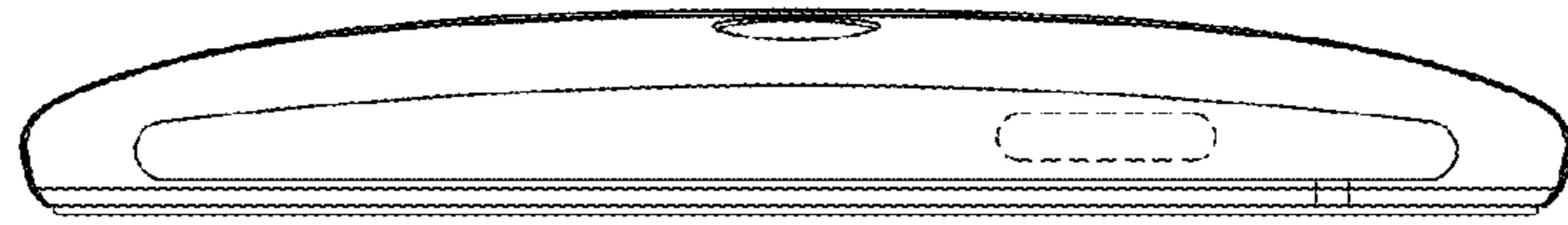

FIG. 14

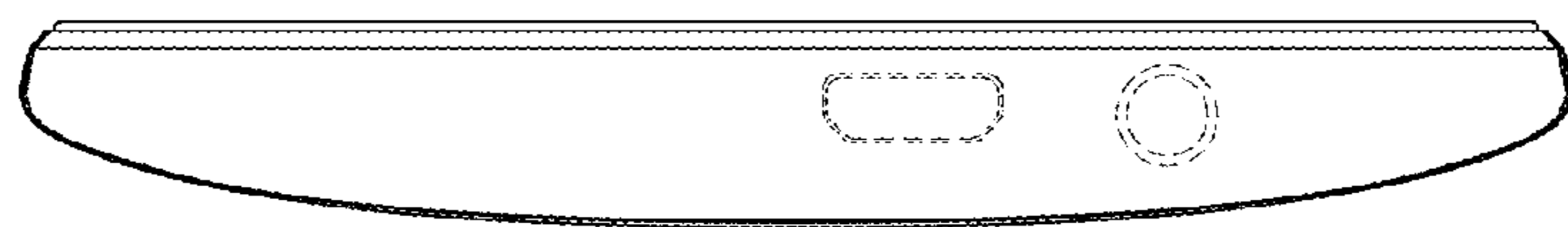

FIG. 15

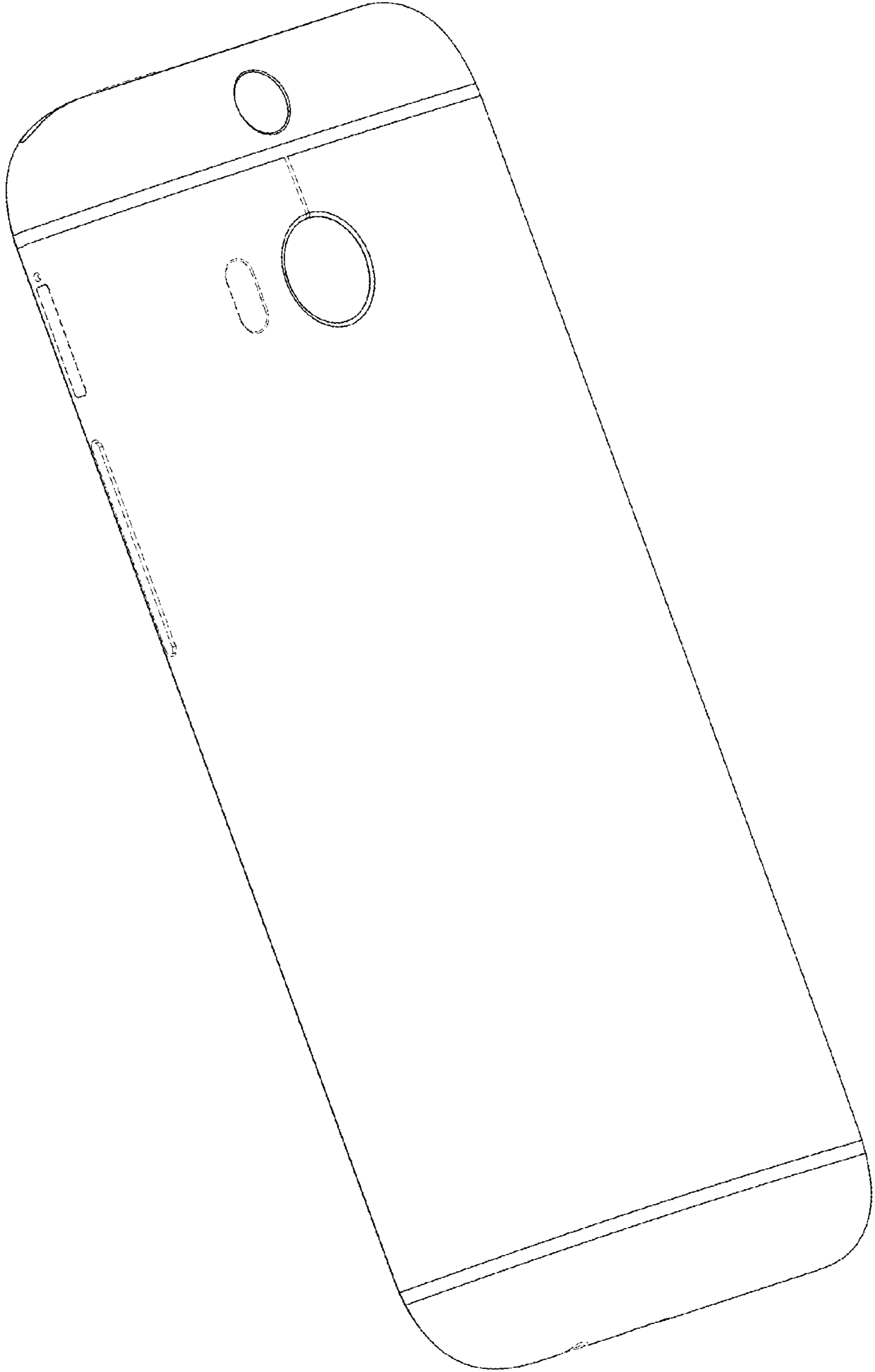

FIG. 16

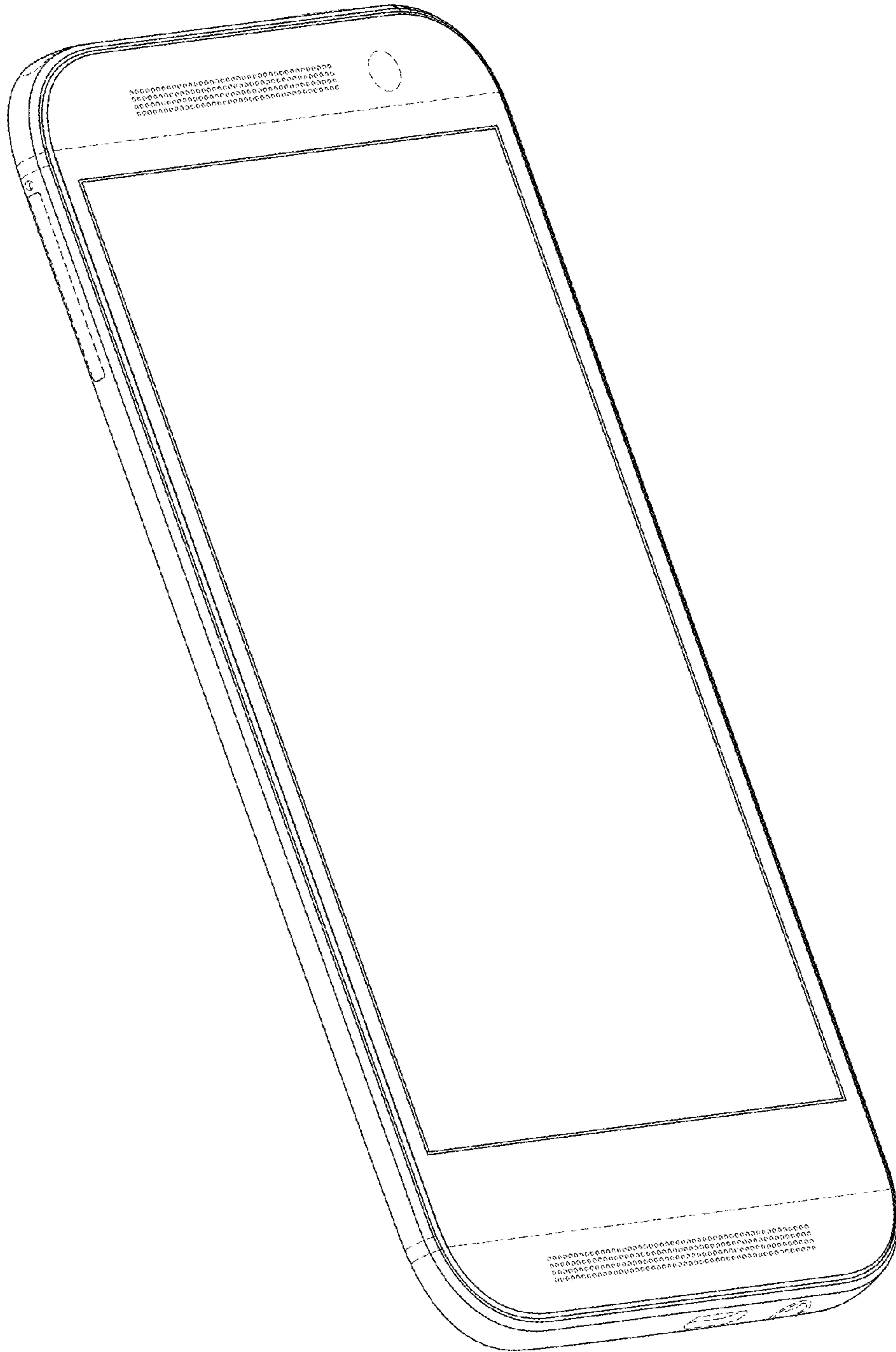

FIG. 17

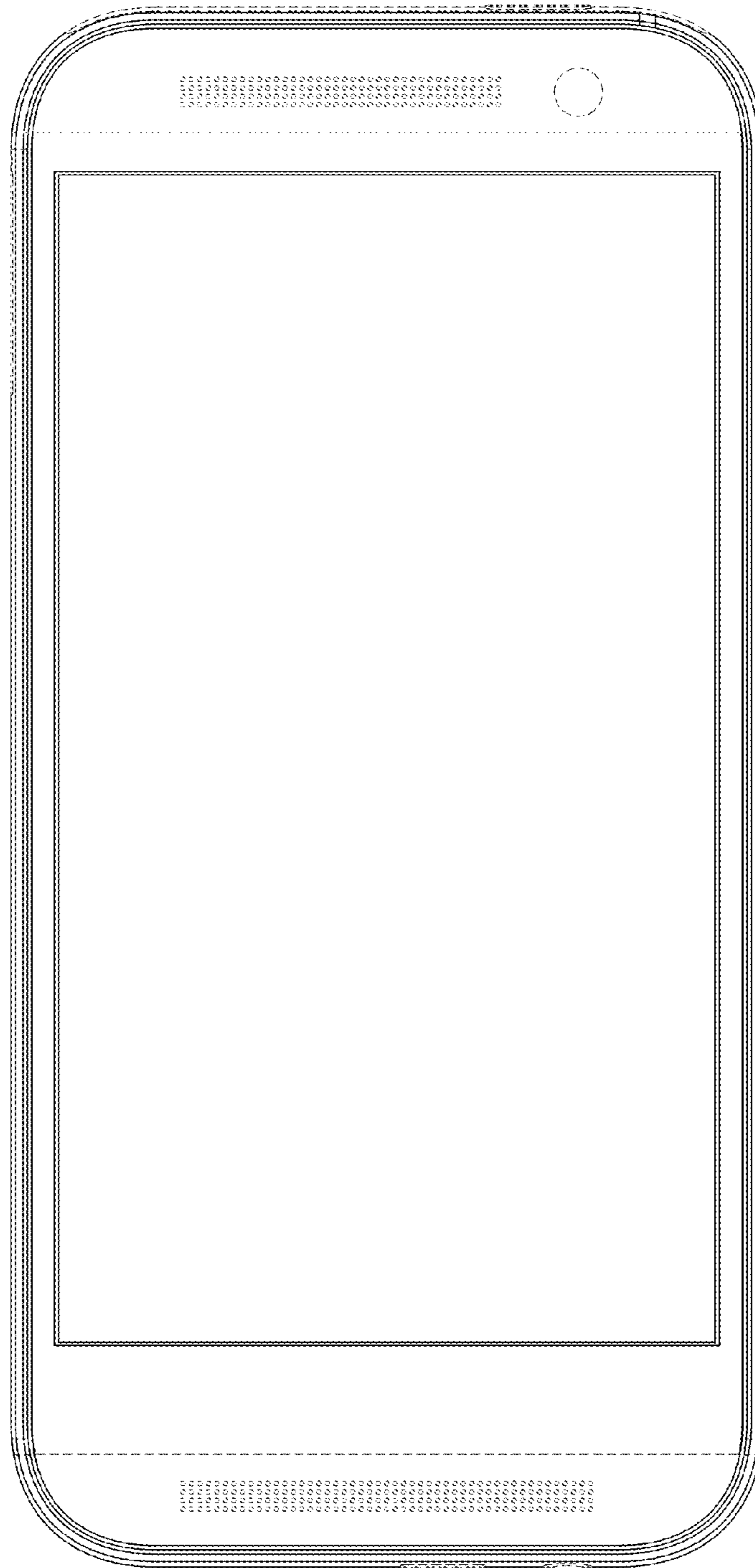

FIG. 18

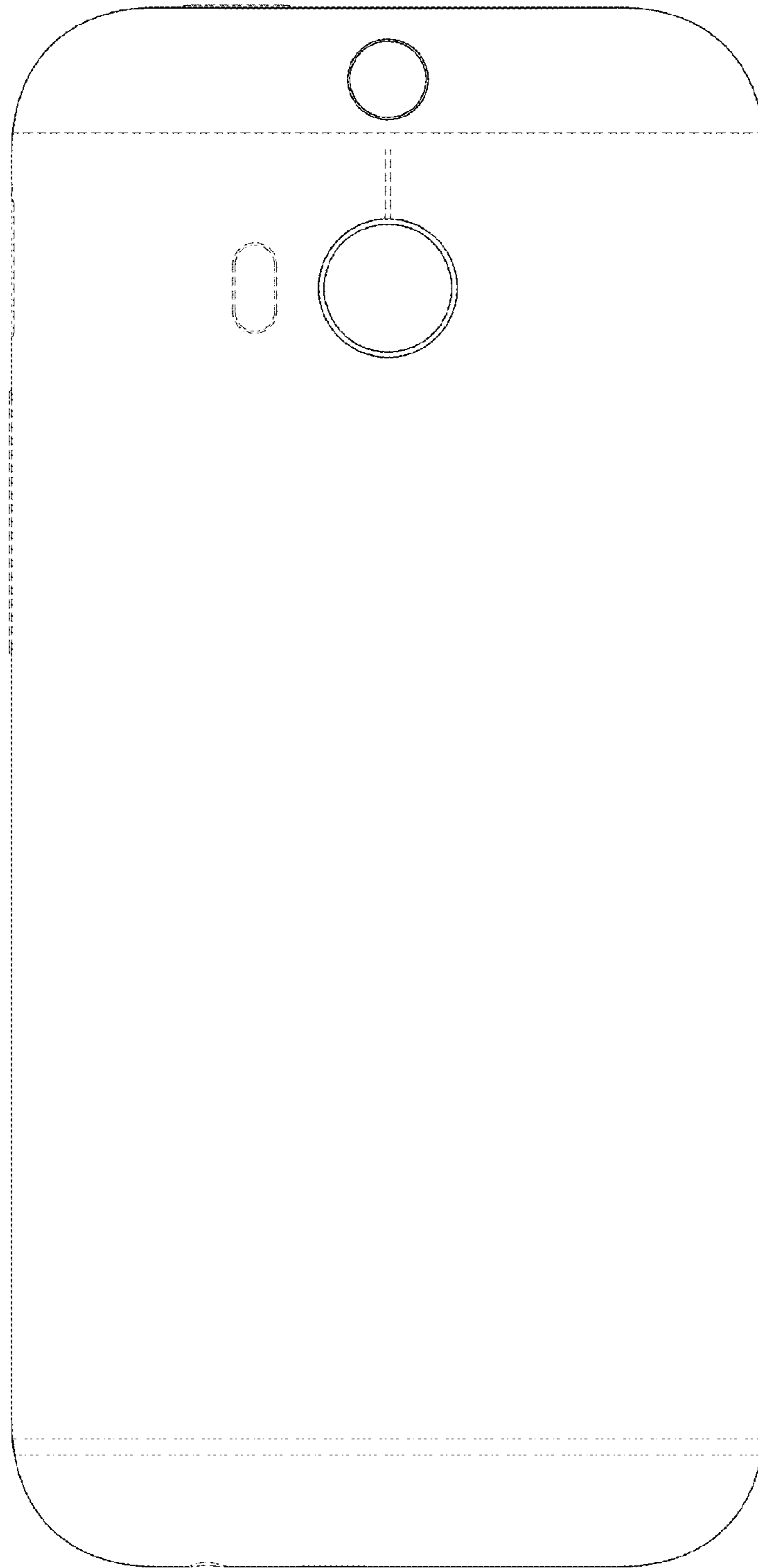

FIG. 19



FIG. 20

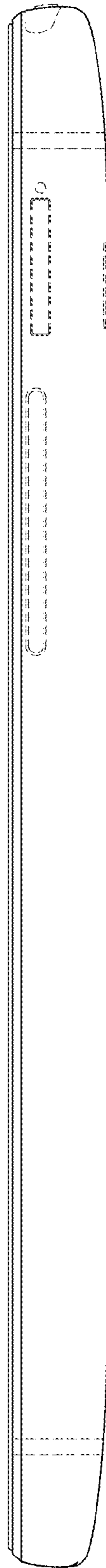

FIG. 21

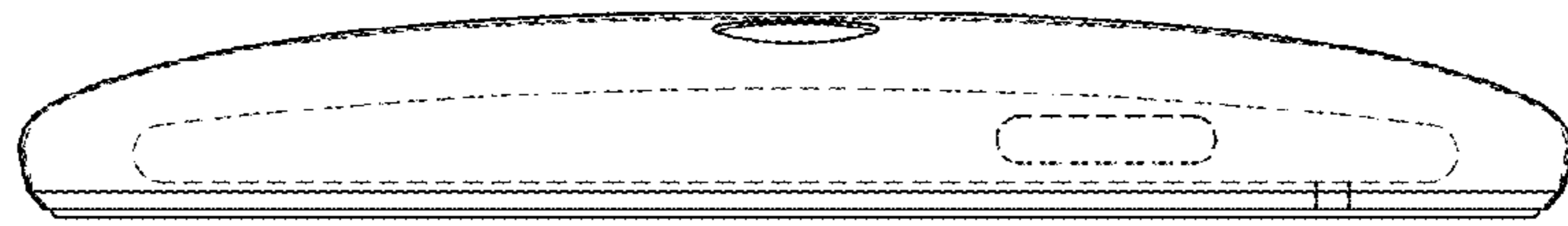

FIG. 22

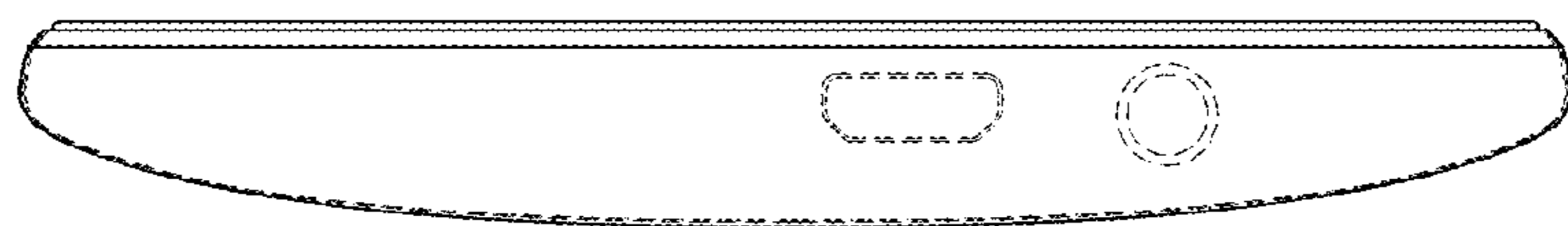

FIG. 23

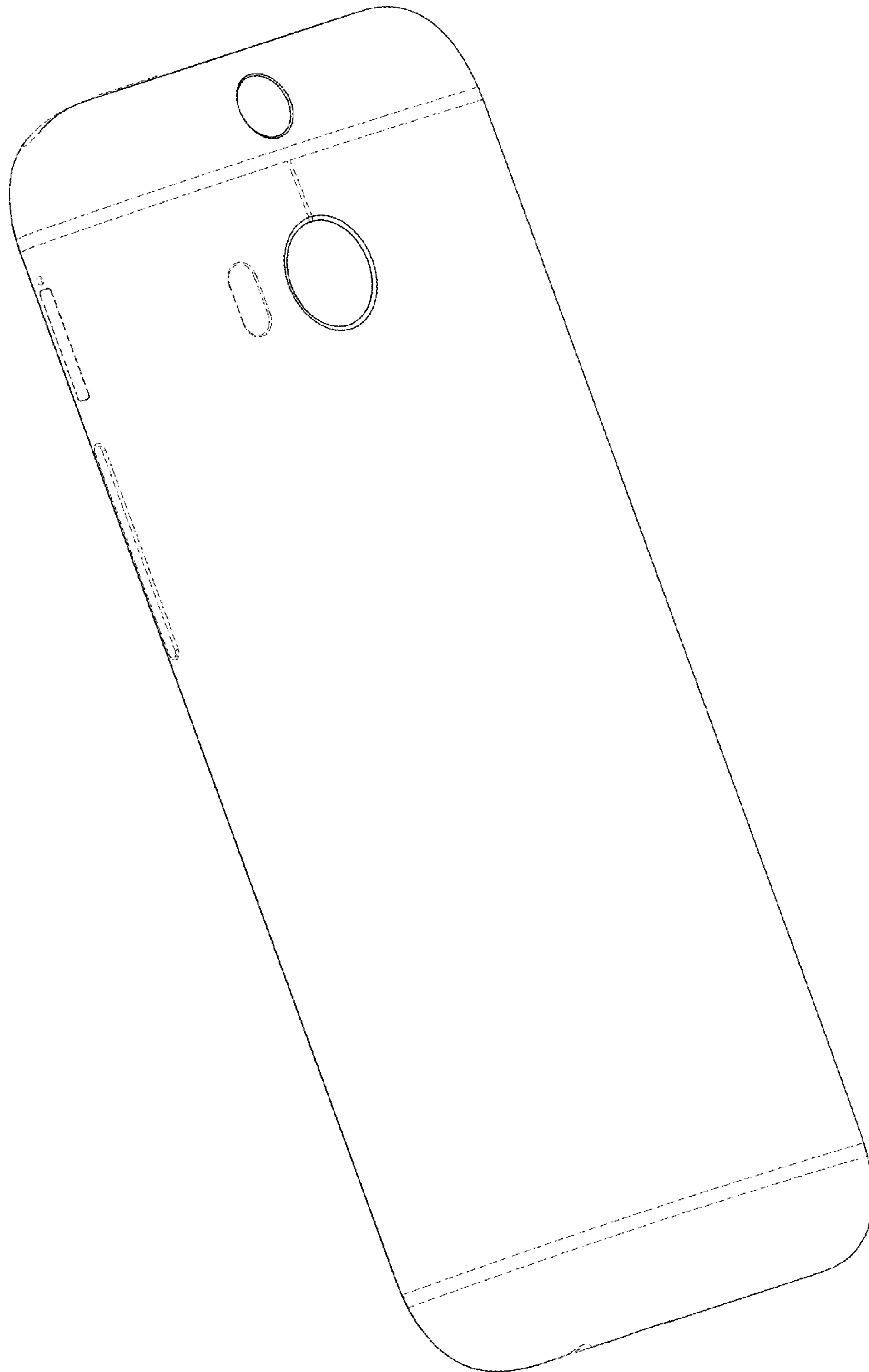

FIG. 24