



US00D742336S

(12) **United States Design Patent**  
**Panis et al.**

(10) **Patent No.:** **US D742,336 S**

(45) **Date of Patent:** **\*\* \*Nov. 3, 2015**

(54) **MODULAR SWITCH**

(71) Applicant: **Pass & Seymour, Inc.**, Syracuse, NY  
(US)

(72) Inventors: **Pierre-Yves Panis**, Isle (FR); **Theodore Junko**, Manlius, NY (US); **Gerald R. Savicki, Jr.**, Canastota, NY (US)

(73) Assignee: **Pass & Seymour, Inc.**, Syracuse, NY  
(US)

(\*) Notice: This patent is subject to a terminal disclaimer.

(\*\*) Term: **14 Years**

(21) Appl. No.: **29/482,482**

(22) Filed: **Feb. 19, 2014**

**Related U.S. Application Data**

(62) Division of application No. 29/414,397, filed on Feb. 28, 2012, now Pat. No. Des. 709,463.

(51) **LOC (10) Cl.** ..... **13-03**

(52) **U.S. Cl.**  
USPC ..... **D13/169**

(58) **Field of Classification Search**

USPC ..... D13/162, 164, 171, 177; 174/66;  
200/5 R, 5 A, 1 B, 293, 296, 329, 406,  
200/513, 520, 530, 302.1, 302.2, 314, 315,  
200/341, 344; 338/198-200; 307/112, 115,  
307/125, 139, 157

CPC ..... H01H 9/02; H01H 9/0271; H01H 9/16;  
H01H 9/18; H01H 6/161; H01H 9/181;  
H01H 9/182; H01H 13/04; H01H 13/14;  
H01H 13/20; H01H 13/30; H01H 19/635;  
H01H 23/00; H01H 23/02; H01H 23/025;  
H01H 23/04; H01H 23/145; H01H 23/148;  
H01H 23/205; H01H 23/30; H05B 33/0803;  
H05B 33/0863; H05B 37/02; H05B 37/0254;  
H05B 37/0272; H05B 39/02; H05B 39/04;  
H05B 39/085; H05B 39/086; H05B 39/088

See application file for complete search history.

(56) **References Cited**

U.S. PATENT DOCUMENTS

3,651,296 A 3/1972 Yarbrough  
4,808,778 A 2/1989 Fujiyoshi

(Continued)

*Primary Examiner* — Selina Sikder

(74) *Attorney, Agent, or Firm* — Daniel P. Malley; Bond Schoeneck & King, PLLC

(57) **CLAIM**

The ornamental design for a modular switch with a substantially square footprint, as shown and described.

**DESCRIPTION**

FIG. 1 is a full isometric view of a switch having a light transmissive region or marking, the switch being shown as it comes from the factory on its mounting plate, the plate and integral hardware behind it being shown in environmental lines;

FIG. 2 is the same isometric view of the switch depicted in FIG. 1 as seen extending through a central opening of a wall plate cover, the wall plate cover being shown in environmental lines;

FIG. 3 is a front side plan view of the switch depicted in FIG. 1 (Note: no back side plan view is shown because nothing is claimed about that side of the invention);

FIG. 4 is a left side elevation view of the switch depicted in FIG. 1 (Note: the right side elevation view is the mirror image of the left side elevation view);

FIG. 5 is a top side view of the switch depicted in FIG. 1;

FIG. 6 is a bottom side view of the switch depicted in FIG. 1; and,

FIG. 7 is an alternate embodiment of the switch depicted in FIGS. 1-6 without an annular light transmissive region or annular marking.

The broken lines shown in the drawing views show the environment and are for illustrative purposes only and form no part of the claimed design.

**1 Claim, 4 Drawing Sheets**

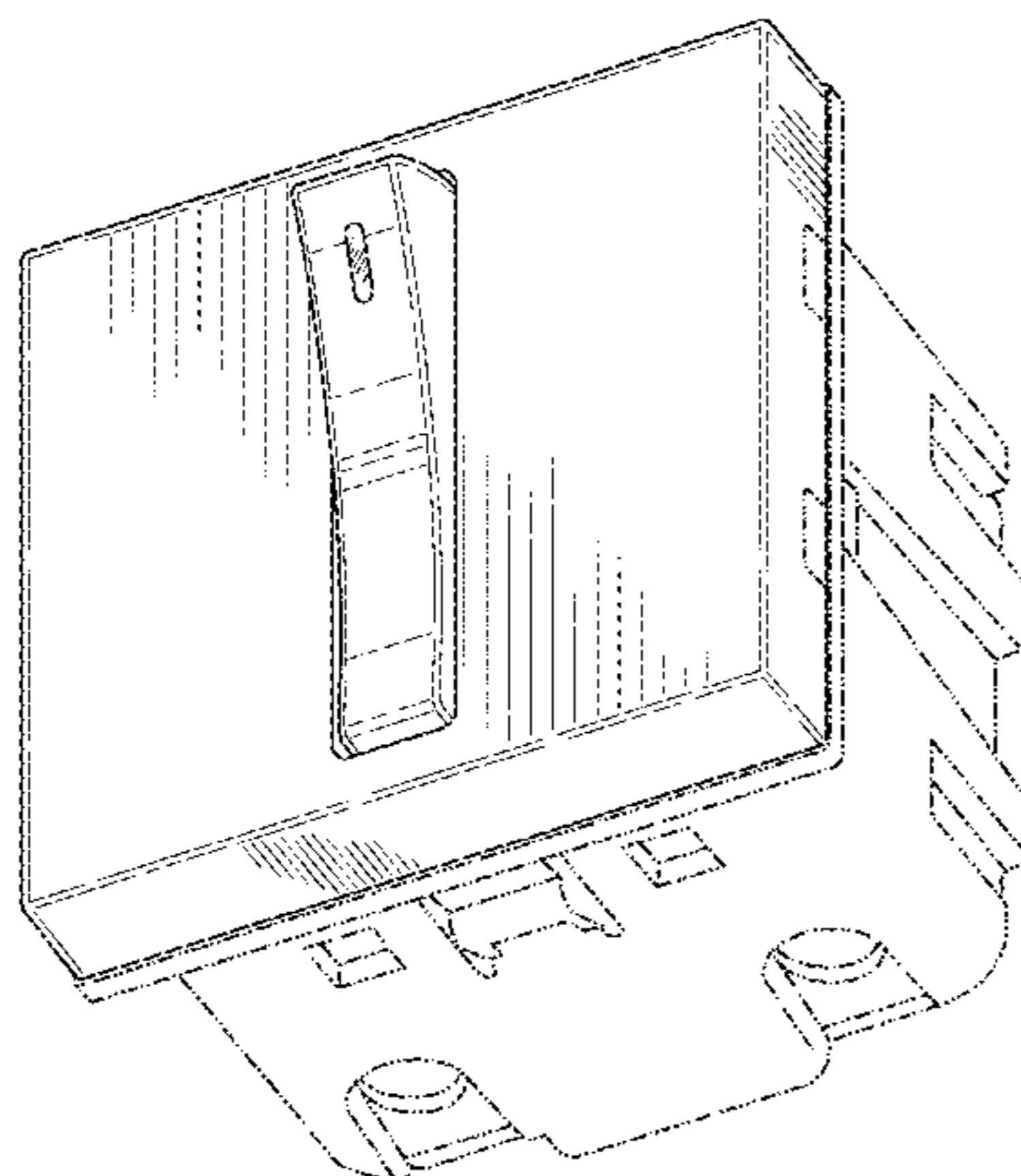

(56)

References Cited

U.S. PATENT DOCUMENTS

5,036,168 A	7/1991	Kikuchi et al.	D557,664 S	12/2007	Hewsen et al.
D360,876 S	8/1995	Hughes	D557,665 S	12/2007	Hewsen et al.
5,934,451 A	8/1999	Yu et al.	D559,710 S	1/2008	Jacoby et al.
D440,946 S	4/2001	Yu	D560,619 S	1/2008	Hewsen et al.
D499,703 S	12/2004	Barone	D567,767 S	4/2008	Hewsen et al.
6,891,117 B1	5/2005	Gouhl et al.	D569,351 S	5/2008	Hewsen et al.
6,909,060 B1 *	6/2005	Shotey et al. .... 200/333	D571,312 S	6/2008	Hewsen et al.
D509,805 S	9/2005	Spira	D572,664 S	7/2008	Hollner et al.
D510,073 S	9/2005	Jacoby et al.	D572,665 S	7/2008	Hollner et al.
D510,074 S	9/2005	Larson et al.	D573,546 S	7/2008	Hollner
D518,446 S	4/2006	Hedderich et al.	D573,956 S	7/2008	Hollner et al.
7,026,564 B1	4/2006	Savicki et al.	7,400,239 B2 *	7/2008	Kiko et al. .... 340/501
D523,824 S	6/2006	Lombardi et al.	D574,333 S	8/2008	Hewson et al.
D533,844 S	12/2006	Larson et al.	D576,566 S	9/2008	Wu et al.
D534,875 S	1/2007	Wu	D576,958 S	9/2008	Hollner
D538,755 S	3/2007	Mayo et al.	D580,374 S	11/2008	Hewson et al.
D539,233 S	3/2007	Mayo et al.	D580,881 S	11/2008	Barbour
D539,236 S	3/2007	Mayo et al.	D580,882 S	11/2008	Barbour
D539,237 S	3/2007	Mayo et al.	D583,335 S	12/2008	Ni
D539,757 S	4/2007	Mayo et al.	D585,840 S	2/2009	Hollner
D540,266 S	4/2007	Mayo et al.	D585,841 S	2/2009	Hollner
D540,267 S	4/2007	Larson et al.	D585,883 S	2/2009	Kaneko
D540,748 S	4/2007	Larson et al.	D585,884 S	2/2009	Pletikosa
D541,221 S	4/2007	Spira	D586,760 S	2/2009	Hollner et al.
D541,222 S	4/2007	Mayo et al.	D586,762 S	2/2009	Nichols et al.
D541,223 S	4/2007	Mayo et al.	D588,070 S	3/2009	Hollner et al.
D541,224 S	4/2007	Mayo et al.	D588,071 S	3/2009	Hollner et al.
D541,755 S	5/2007	Spira	D588,072 S	3/2009	Hollner et al.
D542,226 S	5/2007	Spira	D588,073 S	3/2009	Hollner
D542,227 S	5/2007	Larson et al.	D588,074 S	3/2009	Hollner
D542,229 S	5/2007	Larson et al.	D588,075 S	3/2009	Hollner
D542,231 S	5/2007	Mayo et al.	D595,663 S	7/2009	Hollner
D542,737 S	5/2007	Spira	D595,665 S	7/2009	Hollner
D543,510 S	5/2007	Larson et al.	D609,650 S	2/2010	Chou et al.
D544,450 S	6/2007	Miarta et al.	7,667,155 B1	2/2010	Ni et al.
D545,770 S	7/2007	Mayo et al.	D614,589 S	4/2010	Altonen et al.
D545,771 S	7/2007	Jacoby et al.	7,745,750 B2 *	6/2010	Hewson et al. .... 200/339
D546,293 S	7/2007	Mayo et al.	D619,972 S	7/2010	Felegy et al.
D546,775 S	7/2007	Mayo et al.	7,777,145 B2 *	8/2010	Burrell et al. .... 200/330
D546,776 S	7/2007	Miarta et al.	D624,880 S	10/2010	Felegy et al.
D546,777 S	7/2007	Miarta et al.	D649,122 S	11/2011	Jacoby et al.
D546,778 S	7/2007	Miarta et al.	D649,123 S	11/2011	Jacoby et al.
D546,779 S	7/2007	Miarta et al.	D651,182 S	12/2011	Alderson et al.
D547,273 S	7/2007	Miarta et al.	8,138,435 B2 *	3/2012	Patel et al. .... 200/315
D547,274 S	7/2007	Miarta et al.	8,299,359 B2 *	10/2012	Alderson et al. .... 174/66
D547,731 S	7/2007	Larson et al.	8,459,812 B2	6/2013	Wu et al.
D547,732 S	7/2007	Kumar	D708,151 S *	7/2014	Junko et al. .... D13/169
D548,194 S	8/2007	Spira	D709,463 S *	7/2014	Junko et al. .... D13/169
D551,176 S	9/2007	Hollner	D721,337 S *	1/2015	Junko et al. .... D13/169
D551,177 S	9/2007	Larson et al.	2002/0056628 A1	5/2002	Capella
D551,630 S	9/2007	Larson et al.	2006/0065510 A1	3/2006	Kiko et al.
7,265,308 B2 *	9/2007	Endres et al. .... 200/339	2007/0193863 A1	8/2007	Wu
7,285,723 B2 *	10/2007	Lindenstrauss et al. .... 174/66	2008/0078665 A1	4/2008	Egea Soler
D557,662 S	12/2007	Spira	2009/0189542 A1	7/2009	Wu et al.
			2013/0277191 A1 *	10/2013	Trolese et al. .... 200/501

\* cited by examiner

Fig. 1

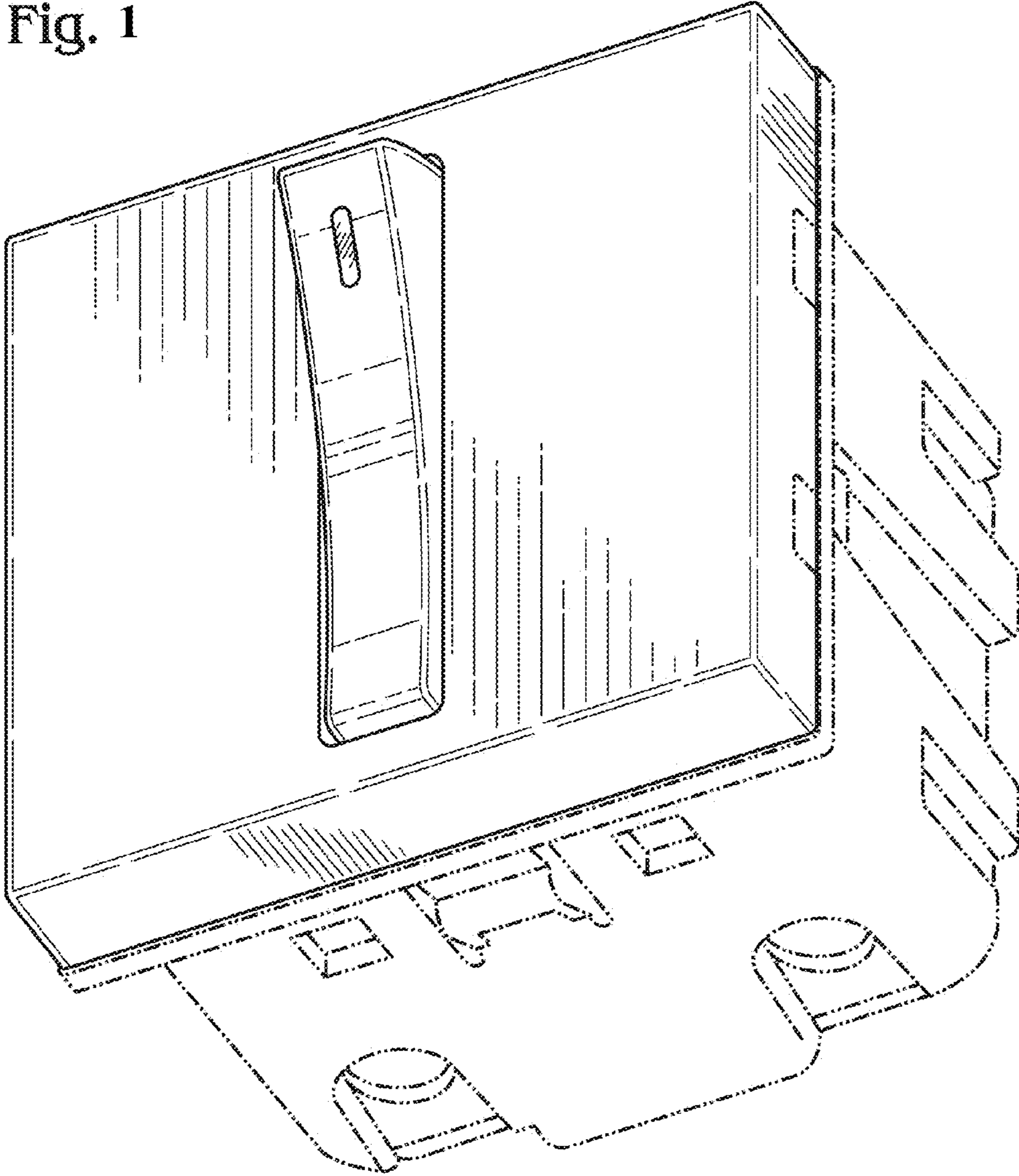

Fig. 2

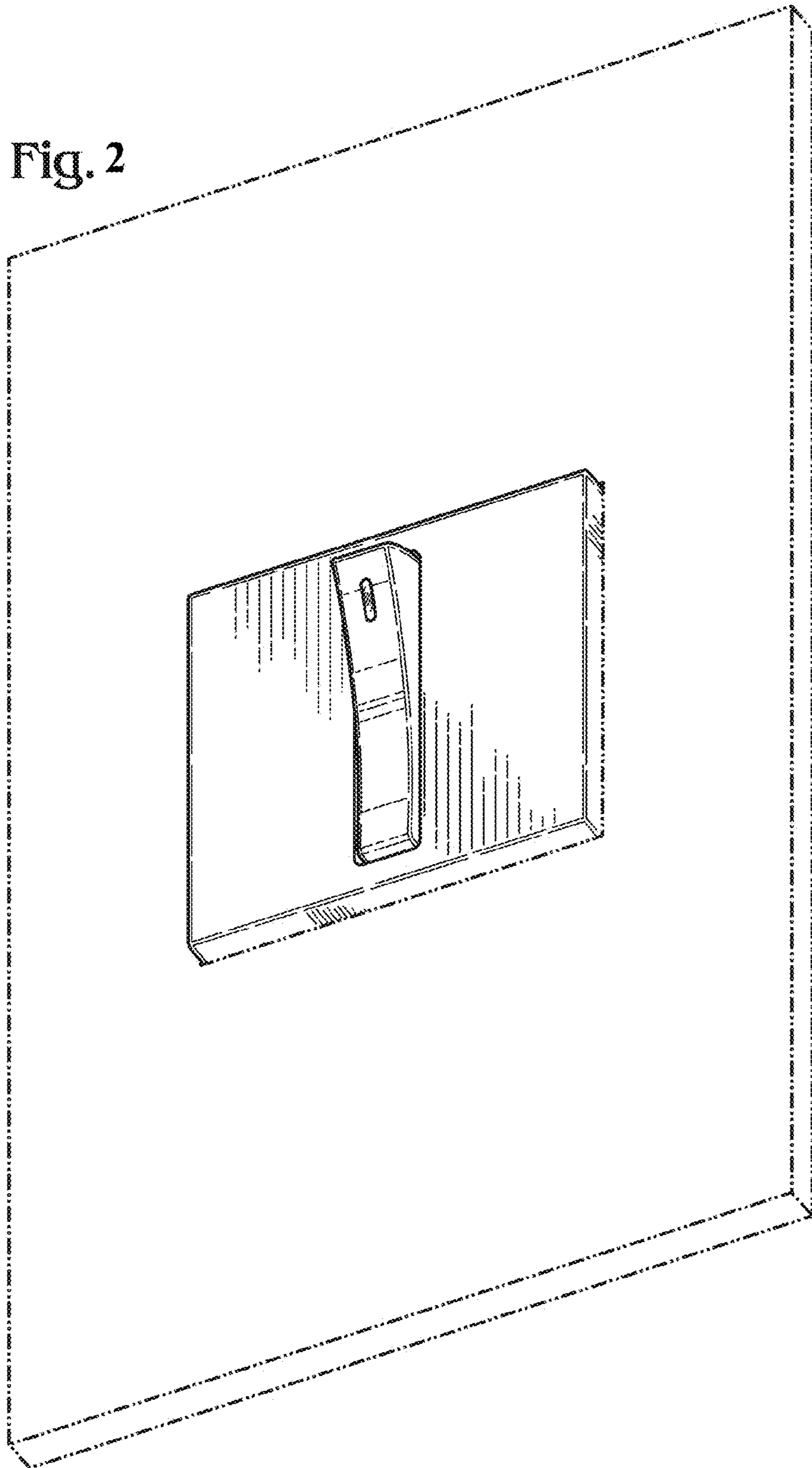

Fig. 3

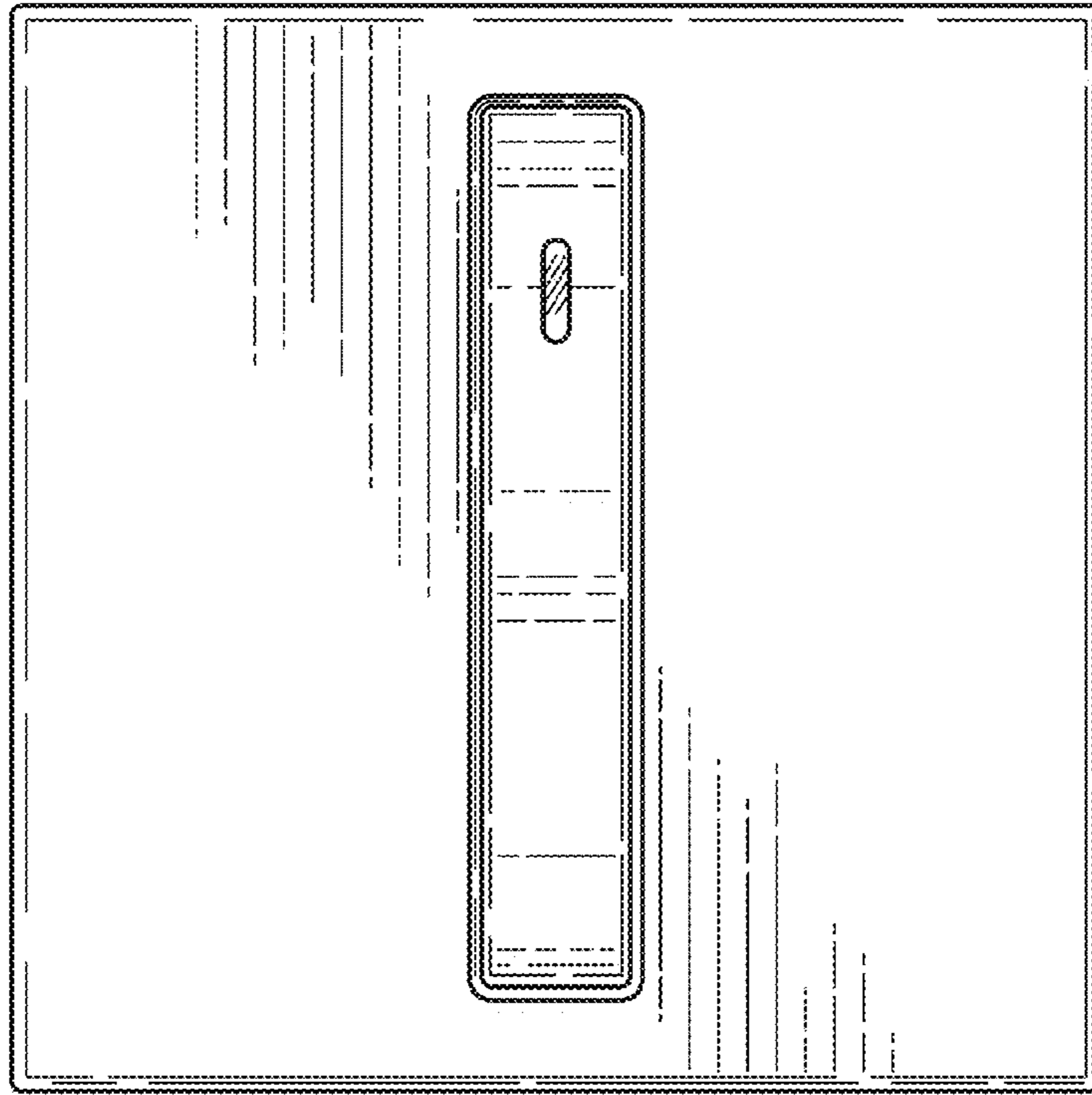

Fig. 4

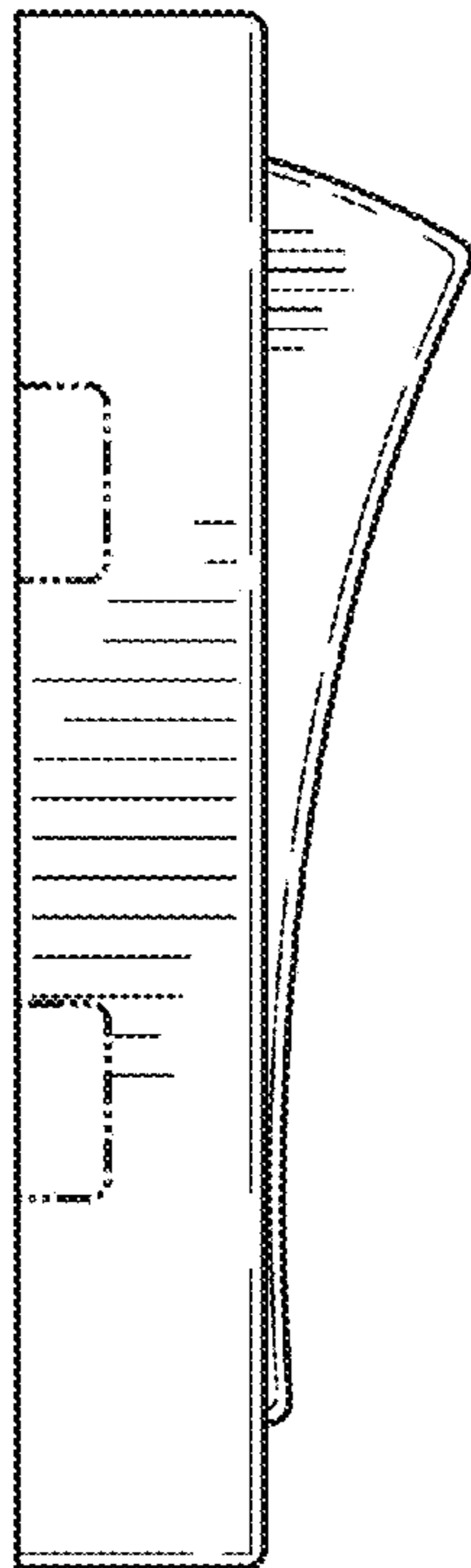

Fig. 5

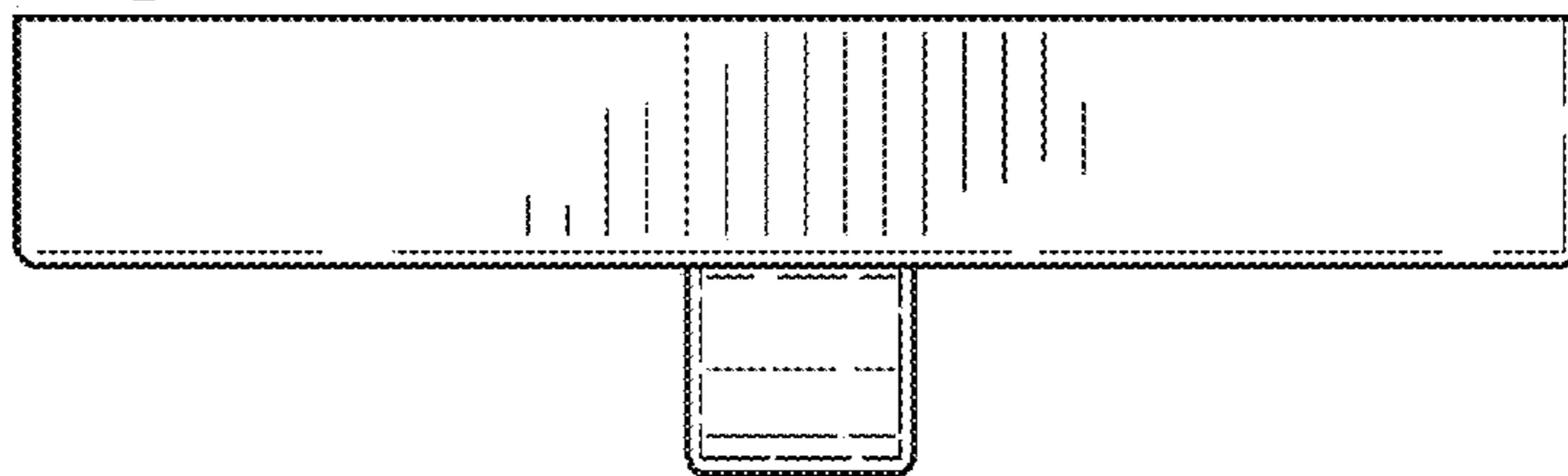

Fig. 6

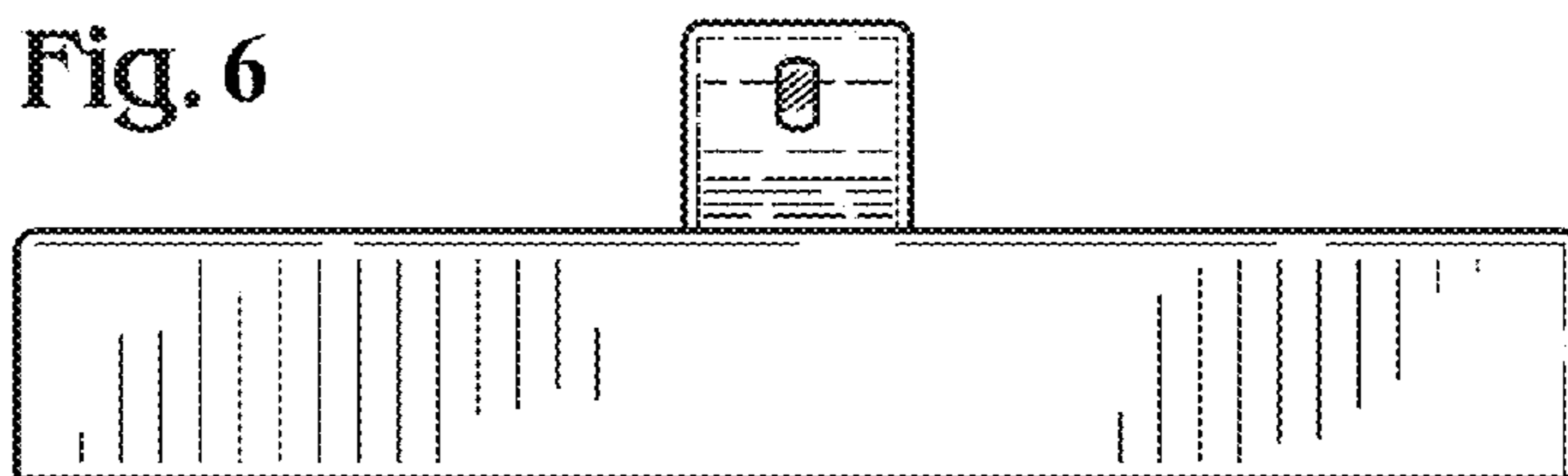

Fig. 7

