



US00D742282S

(12) **United States Design Patent**
Asai et al.

(10) **Patent No.:** **US D742,282 S**

(45) **Date of Patent:** **** Nov. 3, 2015**

(54) **AUTOMOBILE, TOY REPLICA AND/OR
OTHER REPLICAS**

(71) Applicant: **HONDA MOTOR CO., LTD.**,
Minato-ku, Tokyo (JP)

(72) Inventors: **Keisuke Asai**, Wako (JP); **Akihiko
Ohhashi**, Wako (JP)

(73) Assignee: **HONDA MOTOR CO., LTD.**, Tokyo
(JP)

(**) Term: **14 Years**

(21) Appl. No.: **29/437,325**

(22) Filed: **Nov. 15, 2012**

(30) **Foreign Application Priority Data**

May 25, 2012 (JP) 2012-012355

(51) **LOC (10) Cl.** **12-08**

(52) **U.S. Cl.**
USPC **D12/92**

(58) **Field of Classification Search**
USPC D12/86, 90, 91, 92, 98; 296/37.6,
296/181.1, 181.5, 183.1; D21/424, 433,
D21/434

See application file for complete search history.

(56) **References Cited**

U.S. PATENT DOCUMENTS

D584,191 S *	1/2009	Hall et al.	D12/92
D598,812 S *	8/2009	Kim	D12/92
D626,457 S *	11/2010	Lian et al.	D12/92
D636,296 S *	4/2011	Lian et al.	D12/92
D637,521 S *	5/2011	Kim	D12/92
D637,944 S *	5/2011	Lee	D12/92
D640,603 S *	6/2011	Ham	D12/92
D641,666 S *	7/2011	Yi	D12/92
D647,428 S	10/2011	Ohhashi et al.		
D649,493 S *	11/2011	Kim	D12/92

(Continued)

OTHER PUBLICATIONS

2012 Honda Civic: To each their own. Electronic Brochure, Apr. 12, 2011 [retrieved on Jan. 15, 2014]. Retrieved from the Internet: <URL: http://www.auto-brochures.com/makes/Honda/Civic/Honda_US%20Civic_2012.pdf>.*

(Continued)

Primary Examiner — Philip S Hyder

Assistant Examiner — Darlington Ly

(74) *Attorney, Agent, or Firm* — Westerman, Hattori, Daniels & Adrian, LLP

(57) **CLAIM**

The ornamental design for an automobile, toy replica and/or other replicas, as shown and described.

DESCRIPTION

FIG. 1 is a perspective view from the front left side of a first embodiment of an automobile, toy replica and/or other replicas.

FIG. 2 is a perspective view from the front right side thereof.

FIG. 3 is a front elevation view thereof.

FIG. 4 is a rear elevation view thereof.

FIG. 5 is a left side elevation view thereof.

FIG. 6 is a right side elevation view thereof.

FIG. 7 is a top plan view thereof.

FIG. 8 is a perspective view from the front left side of a second embodiment of an automobile, toy replica and/or other replicas.

FIG. 9 is a perspective view from the front right side thereof.

FIG. 10 is a front elevation view thereof.

FIG. 11 is a rear elevation view thereof.

FIG. 12 is a left side elevation view thereof.

FIG. 13 is a right side elevation view thereof; and,

FIG. 14 is a top plan view thereof.

The broken lines shown in the drawings illustrate portions of the automobile, toy replica and/or other replicas that forms no part of the claimed design.

1 Claim, 14 Drawing Sheets

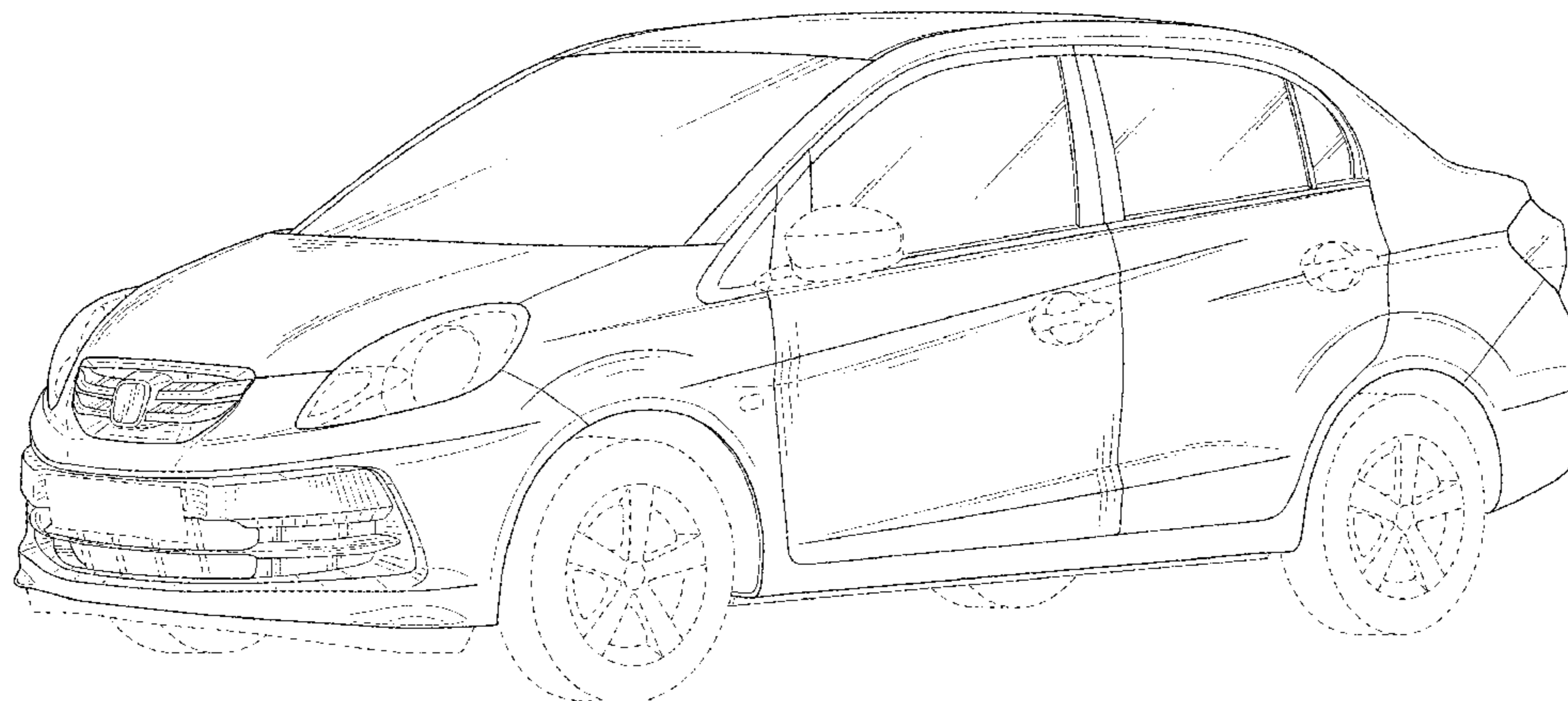

(56)

References Cited

U.S. PATENT DOCUMENTS

D670,201 S * 11/2012 Ham D12/92
D683,660 S * 6/2013 Sugiura et al. D12/92
2010/0301618 A1* 12/2010 Costigan et al. 292/93
2012/0319449 A1* 12/2012 Schenten et al. 297/452.18

OTHER PUBLICATIONS

2013 Honda Civic: 6 Choices. One Icon. Electronic Brochure, Nov. 8, 2012 [retrieved on Jan. 15, 2014]. Retrieved from the Internet:

<URL: http://www.auto-brochures.com/makes/Honda/Civic/Honda_US%20Civic_2013.pdf>.*

2013 Toyota Corolla. Electronic Brochure, Feb. 13, 2012 [retrieved on Jan. 15, 2014]. Retrieved from the Internet: <URL: http://www.auto-brochures.com/makes/Toyota/Corolla/Toyota_US%20Corolla_2013-v2.pdf>.*

* cited by examiner

FIG. 1

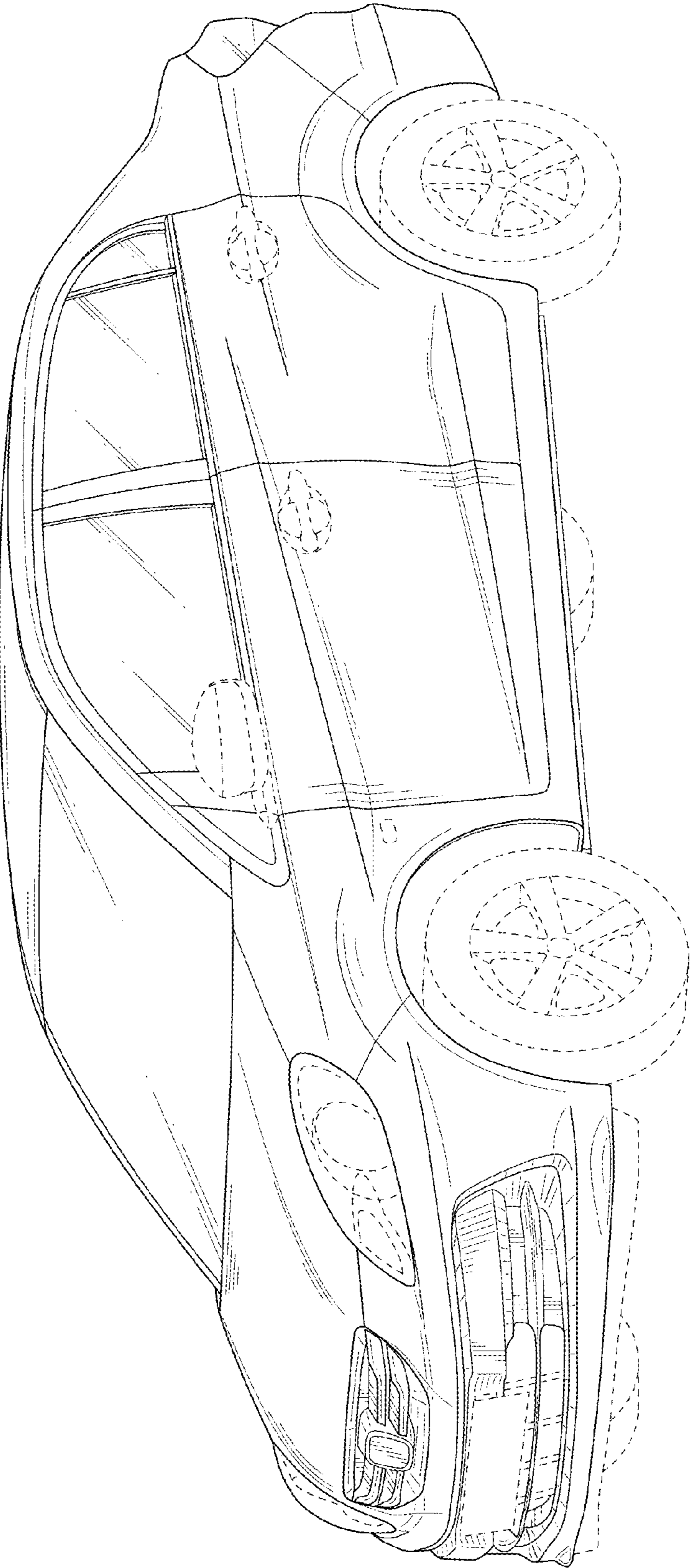

FIG. 2

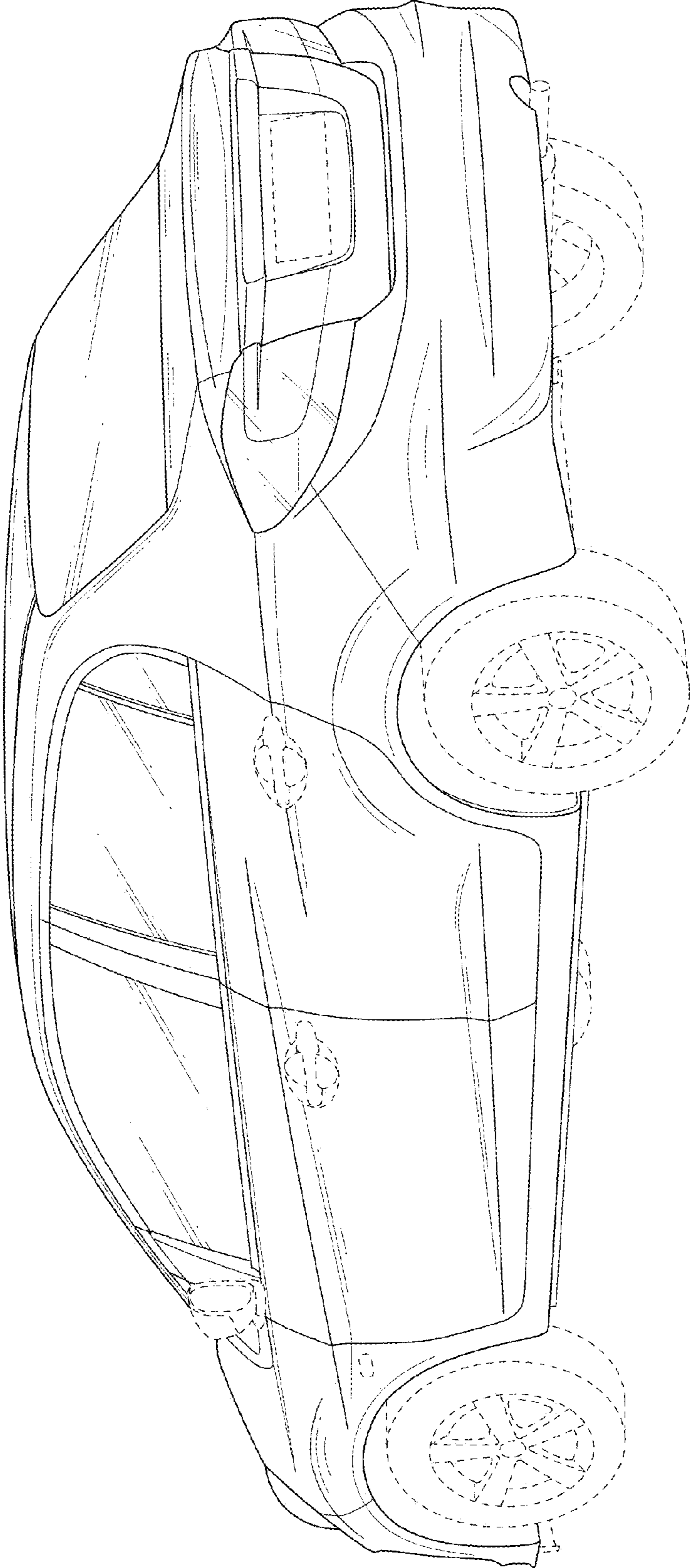

FIG. 3

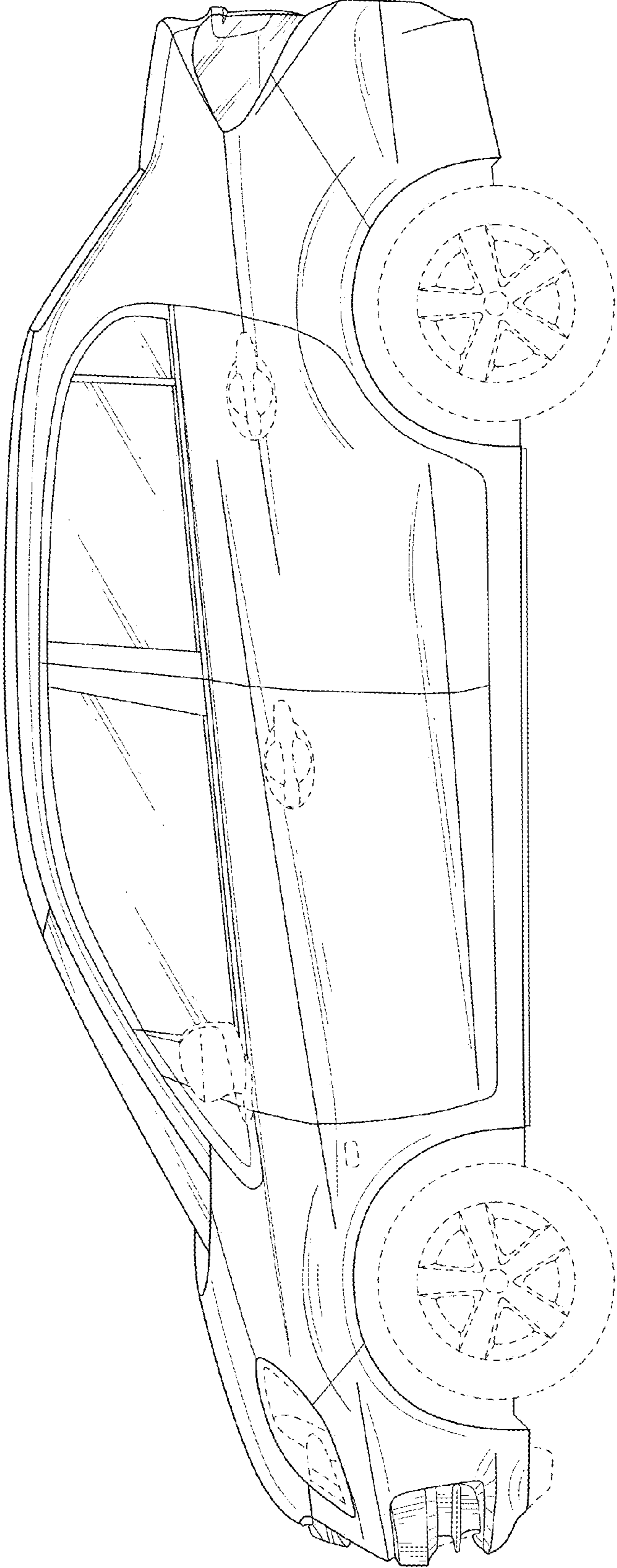

FIG. 4

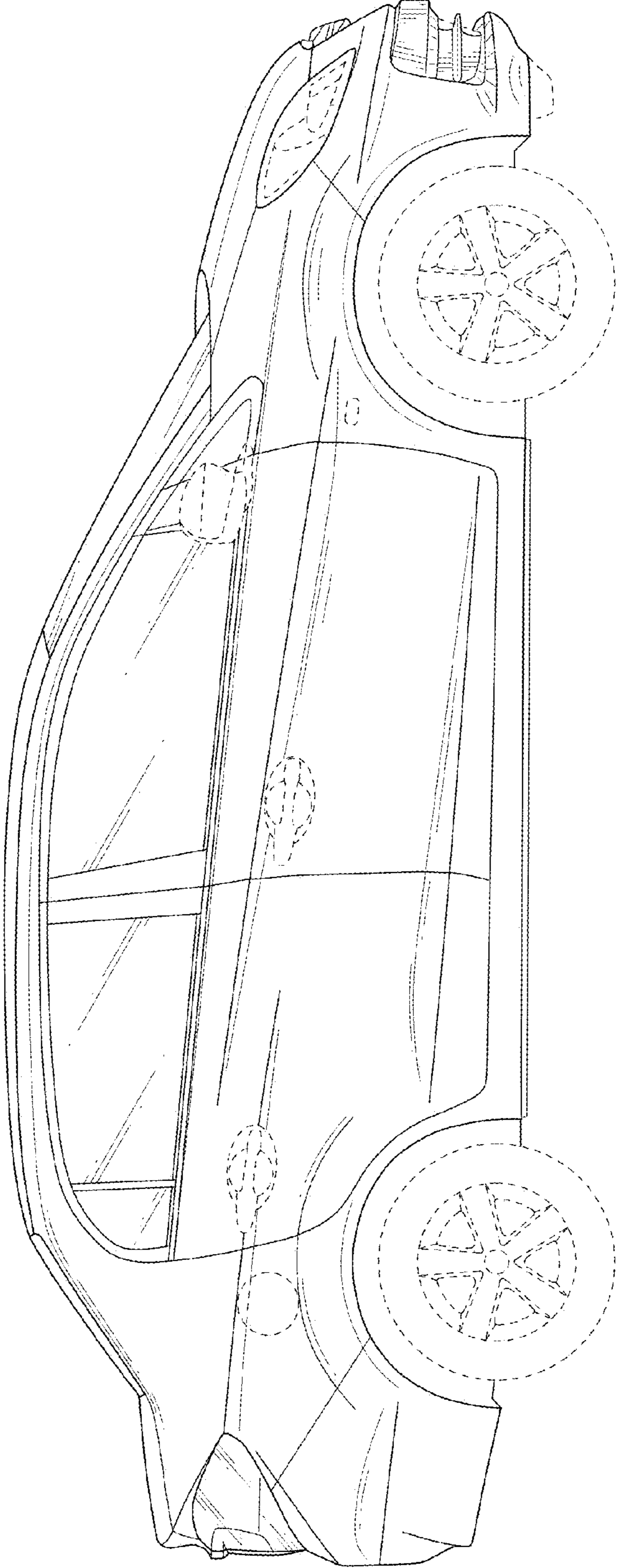

FIG. 5

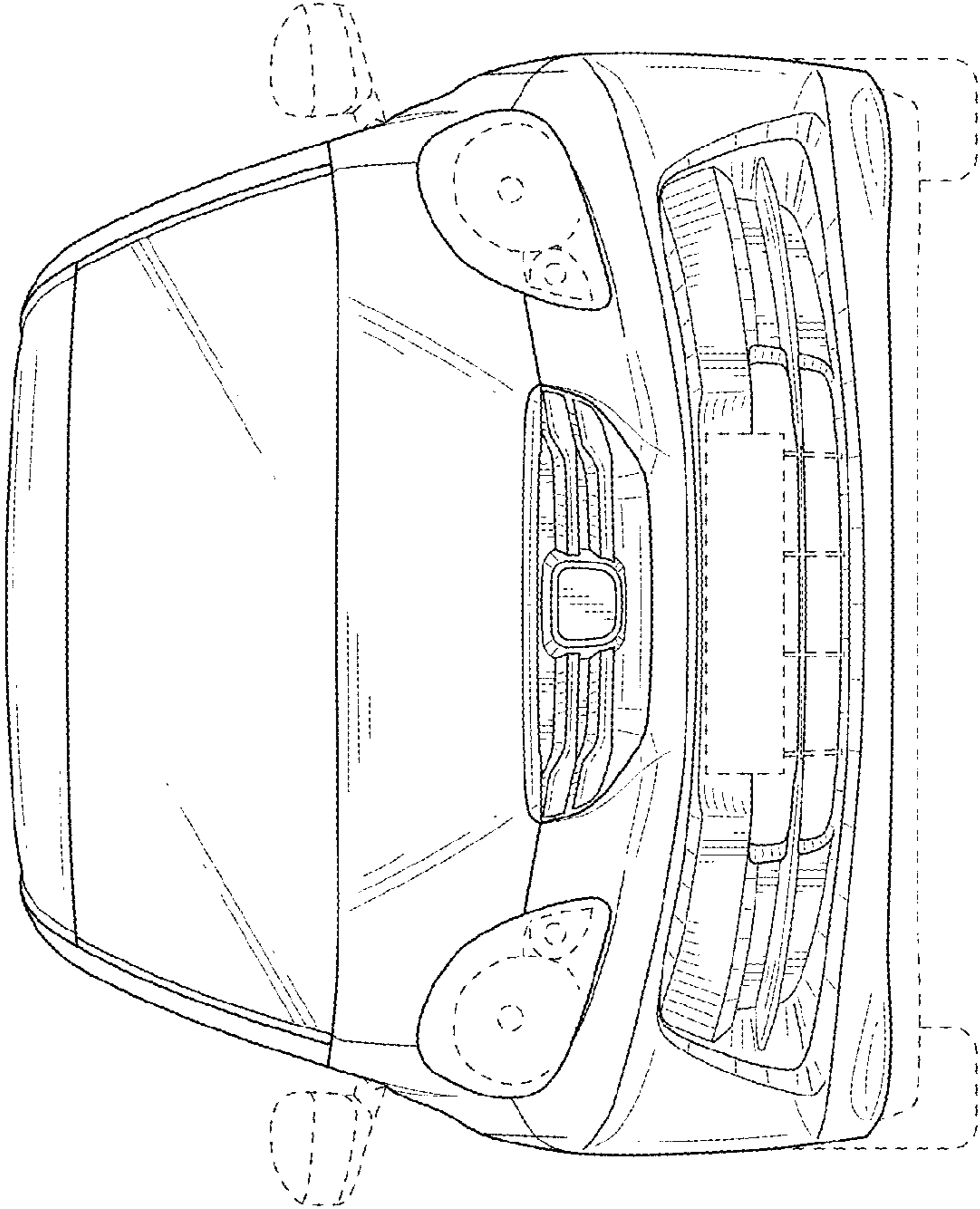

FIG. 6

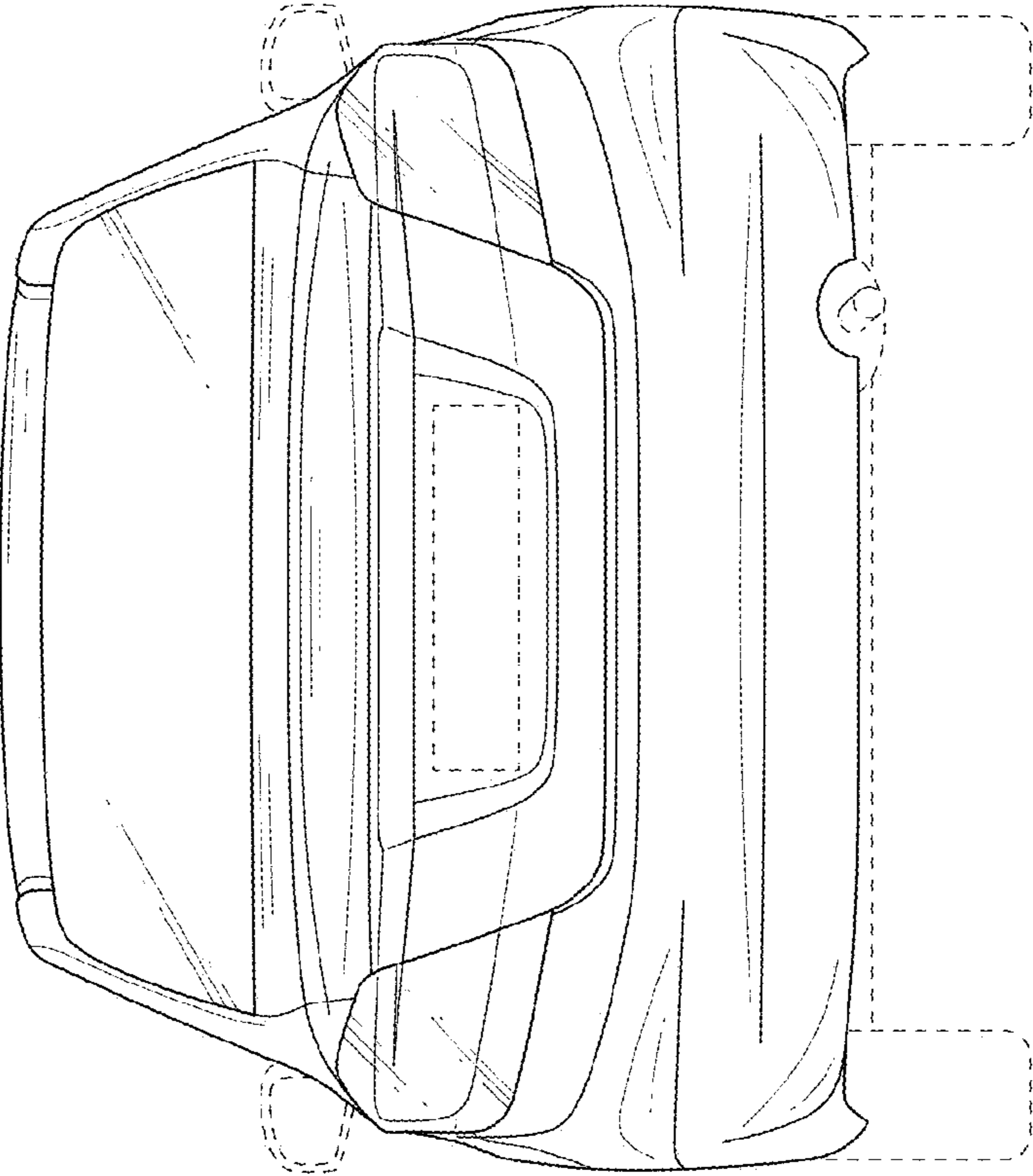

FIG. 7

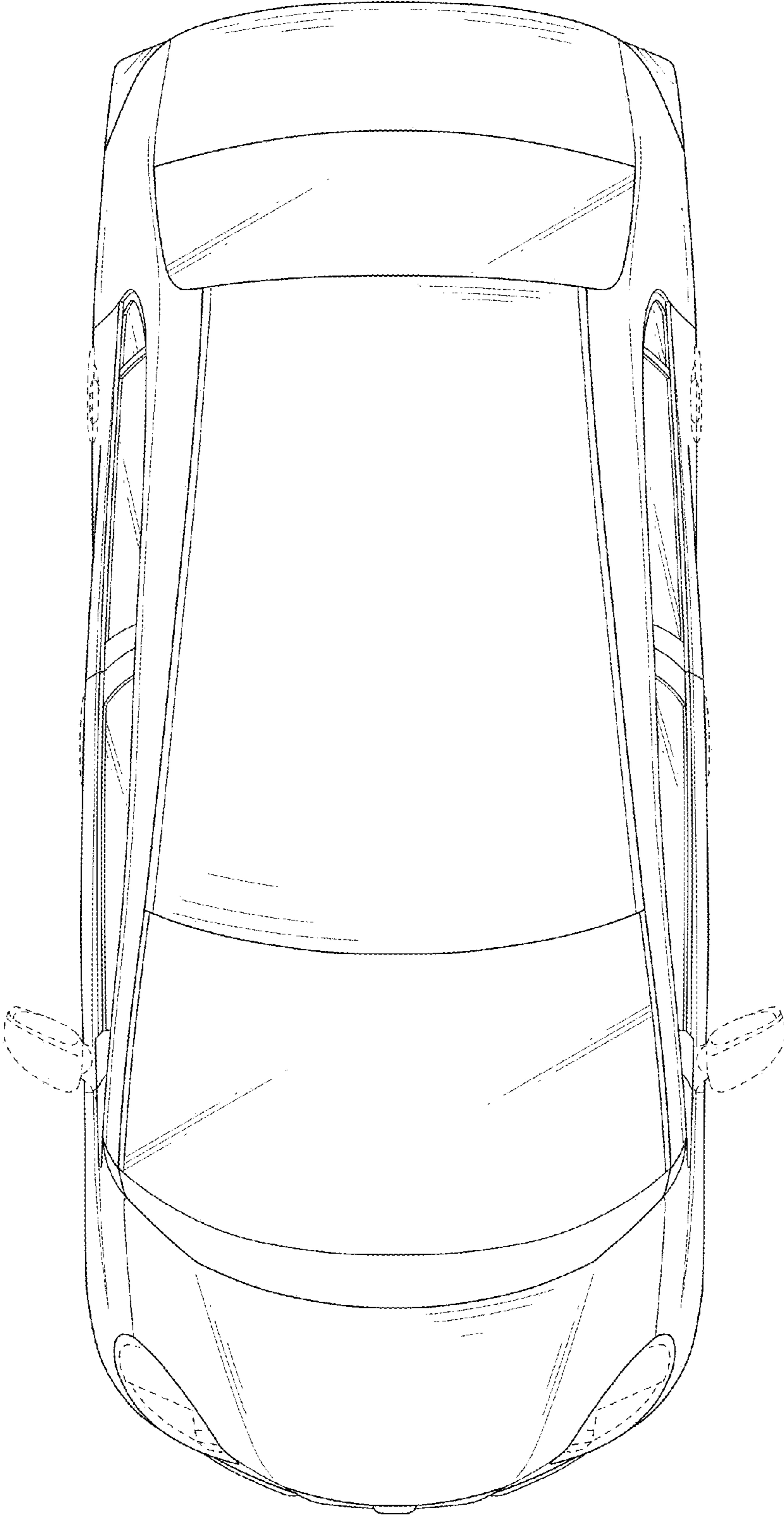

FIG. 8

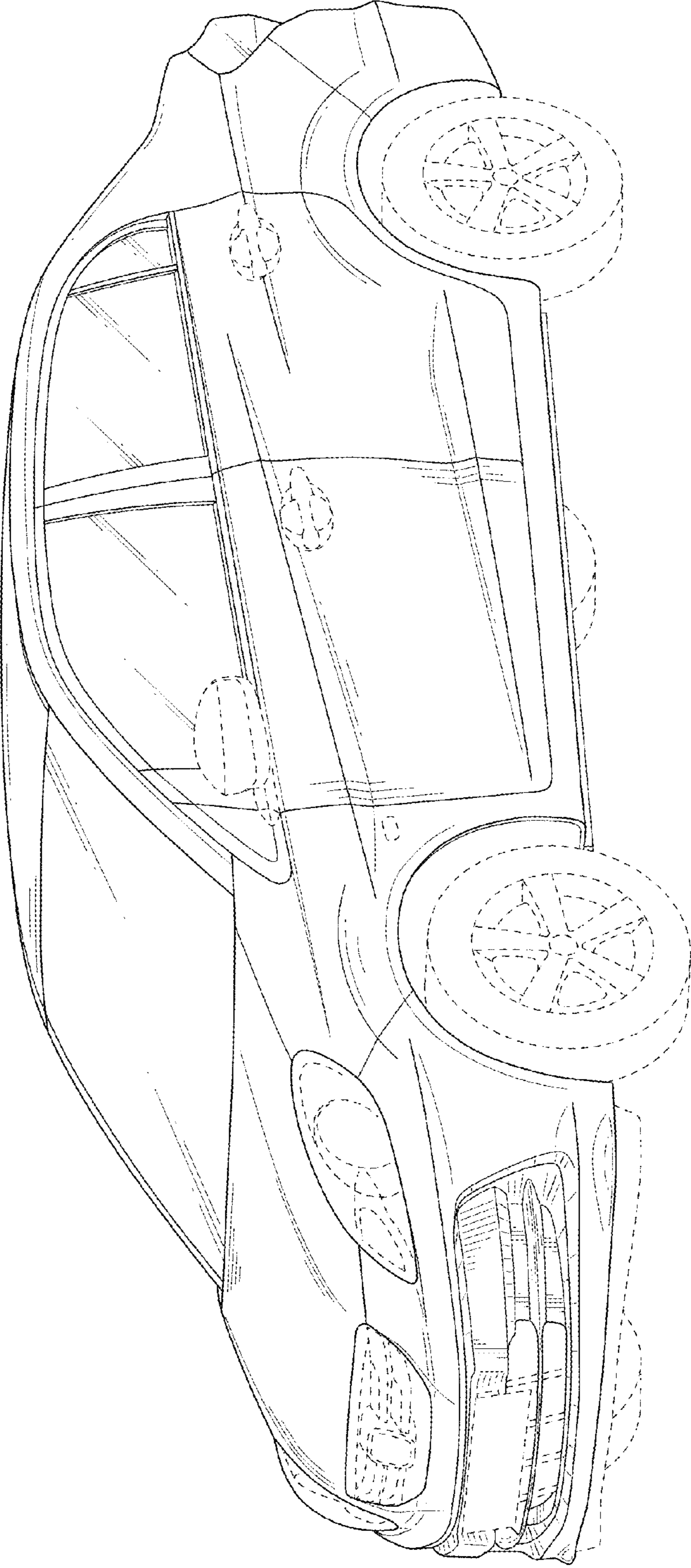

FIG. 9

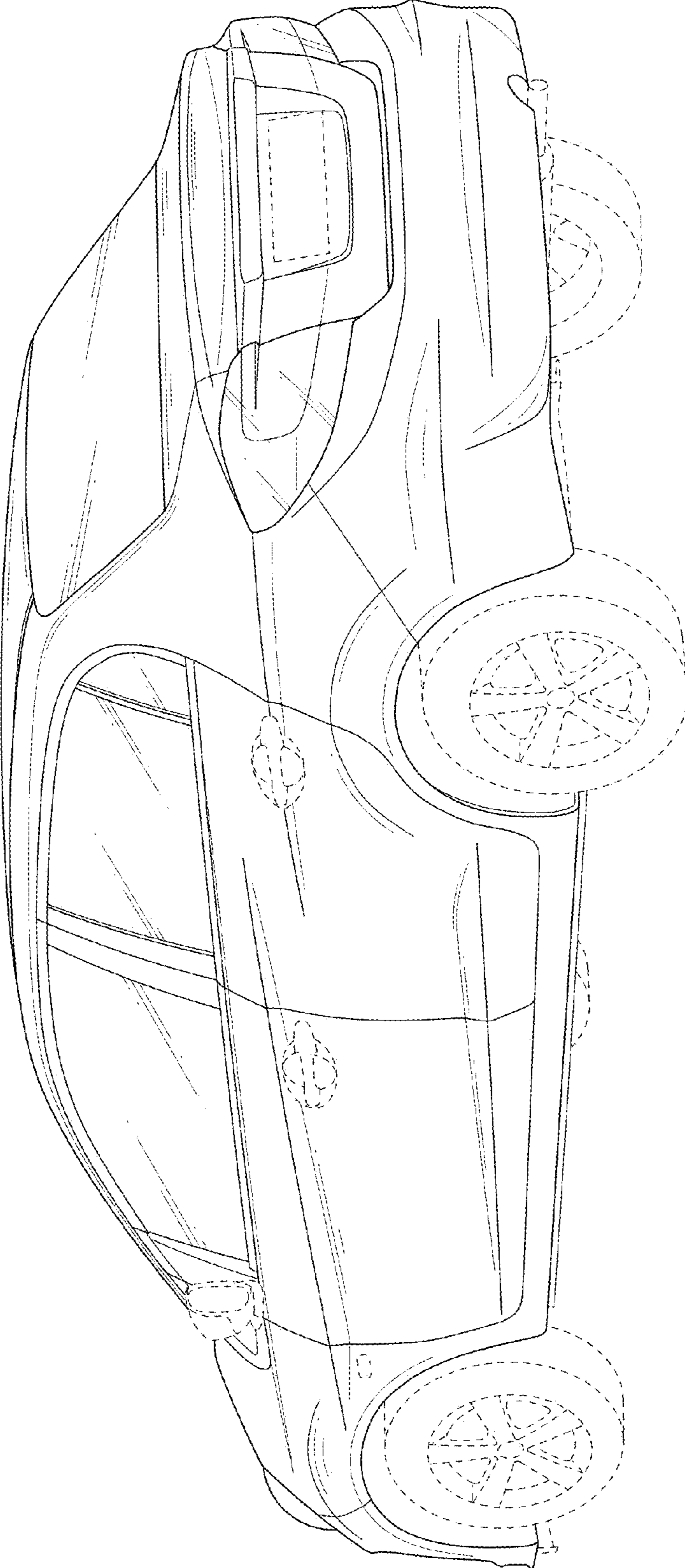

FIG. 10

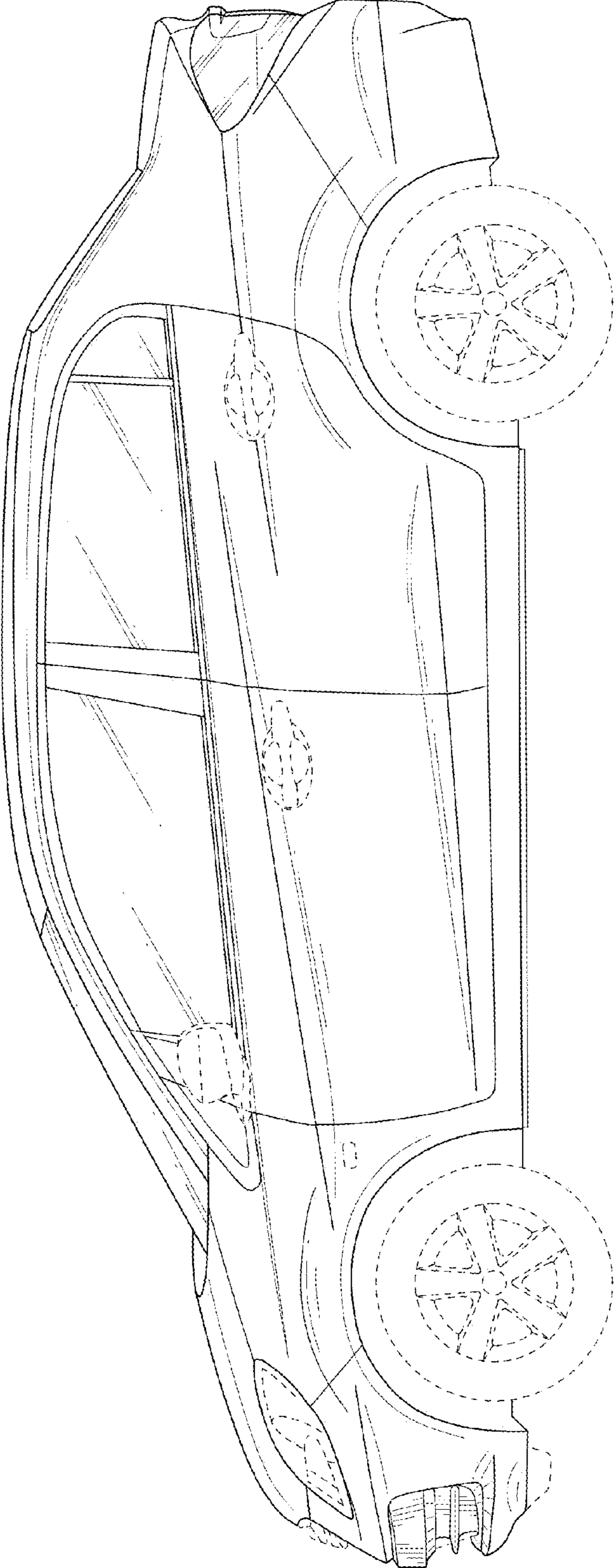

FIG. 11

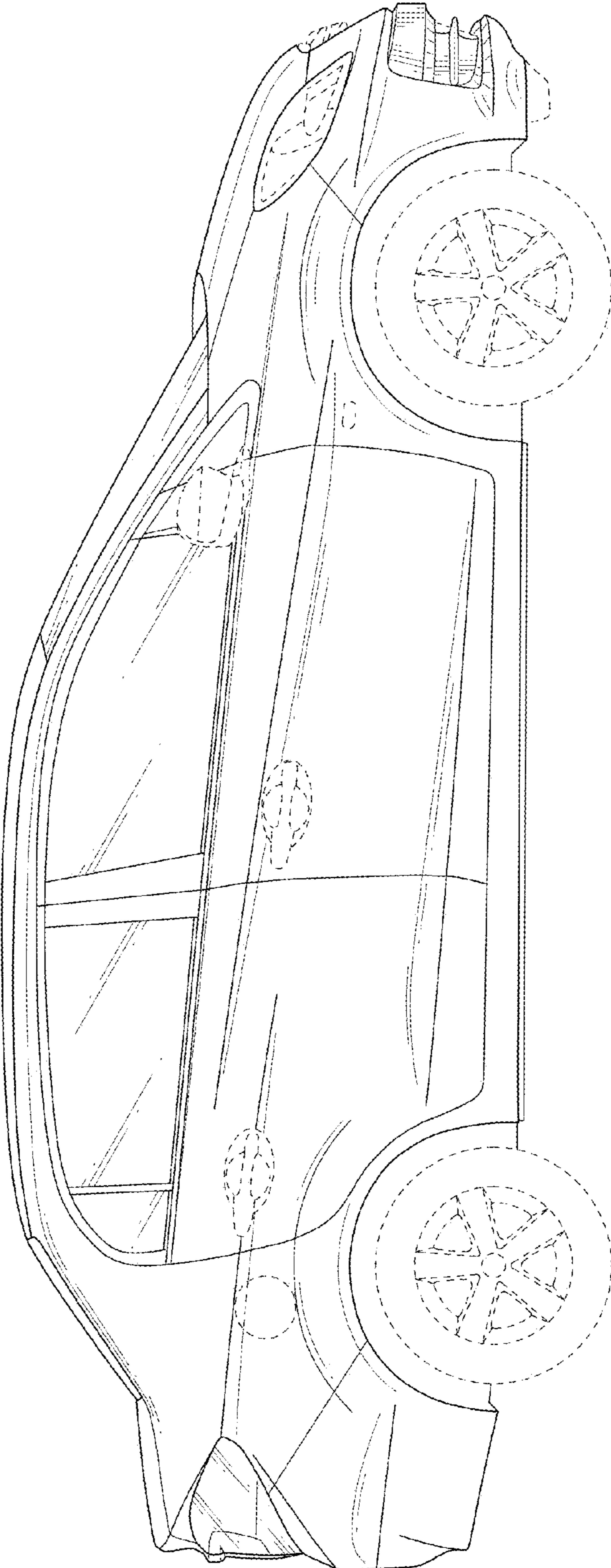

FIG. 12

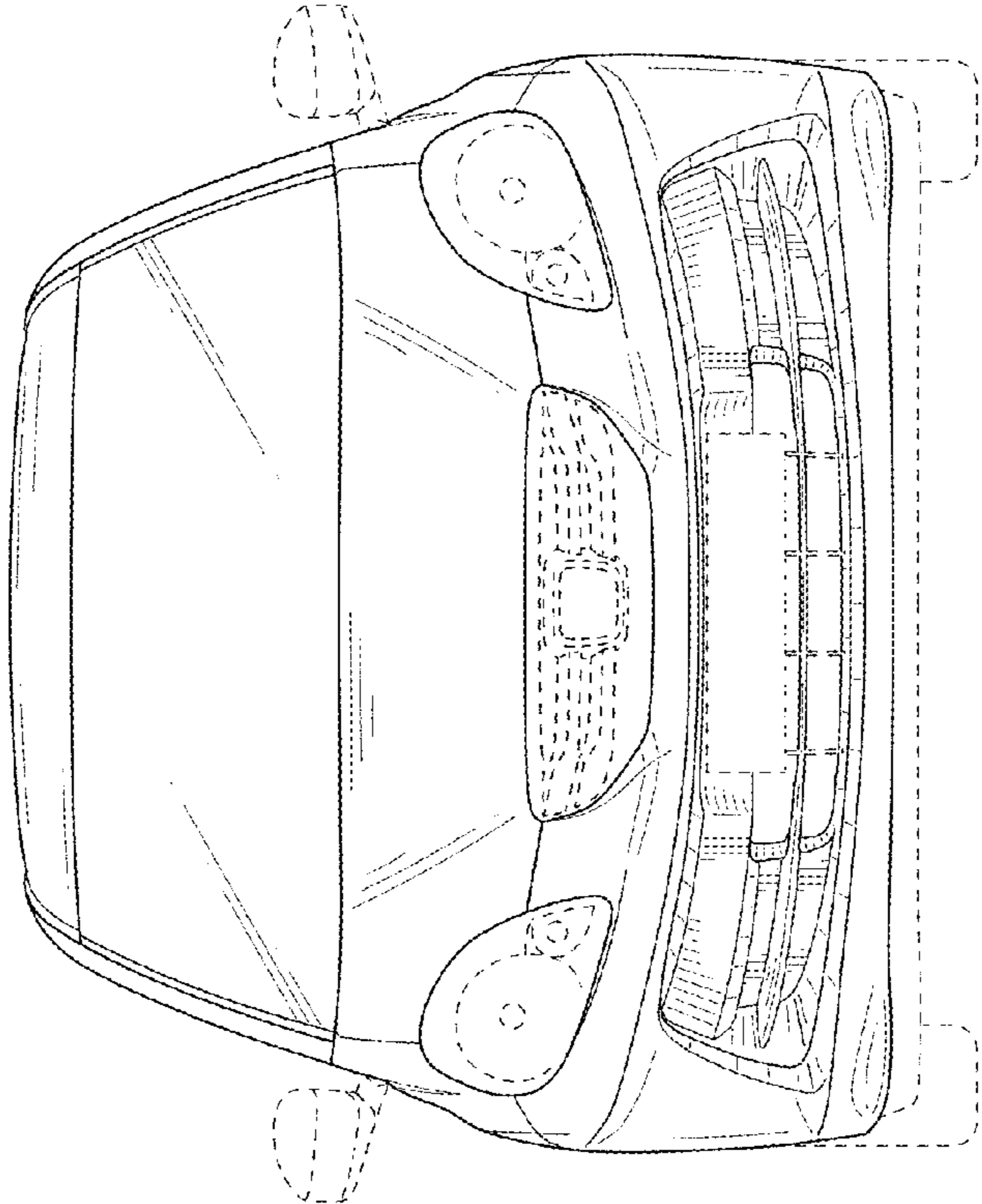

FIG. 13

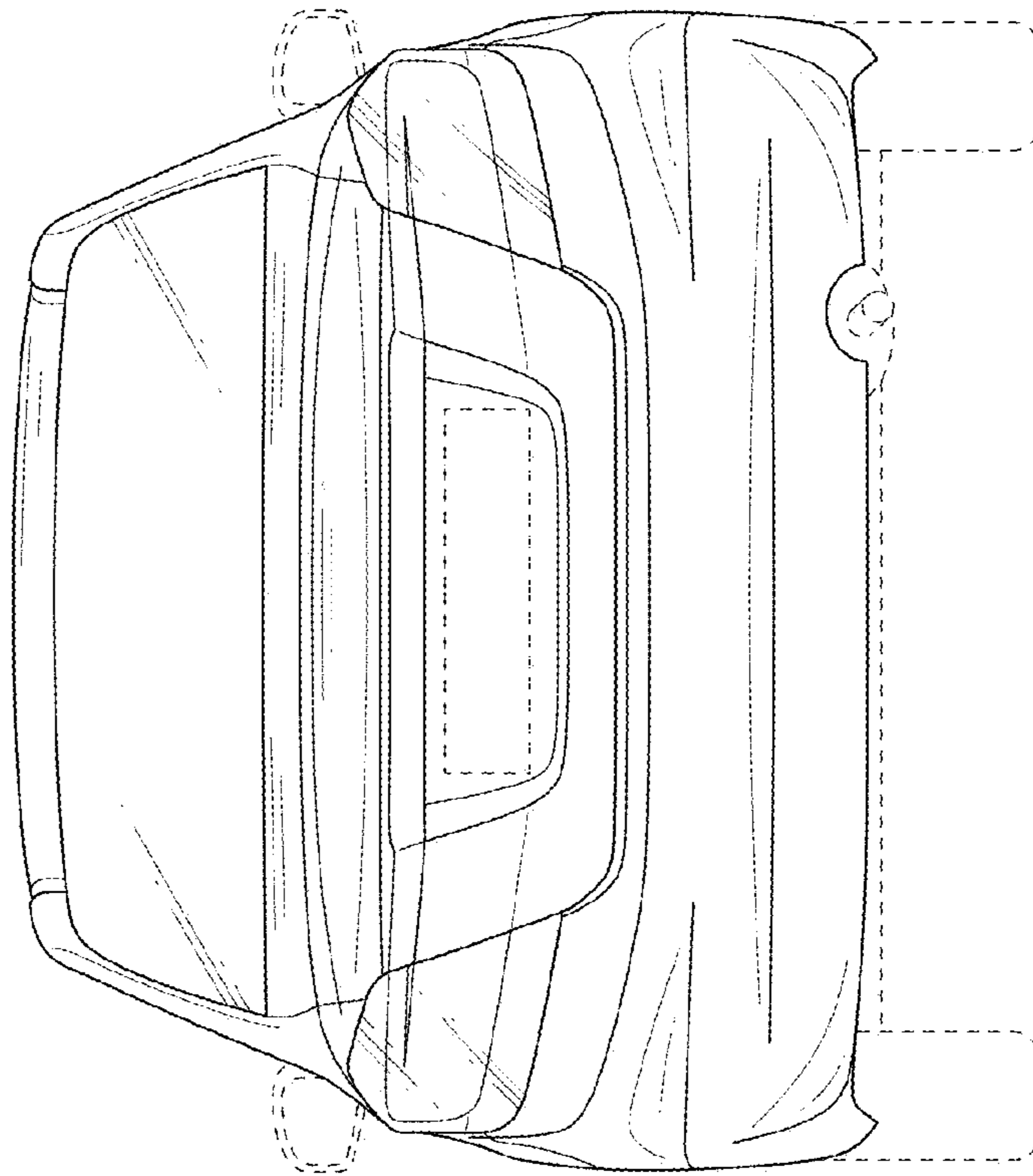

FIG. 14

