



US00D742264S

(12) **United States Design Patent**
Pan

(10) **Patent No.:** **US D742,264 S**

(45) **Date of Patent:** **** Nov. 3, 2015**

(54) **POSTAL SCALE**

(56) **References Cited**

(71) Applicant: **INNOVATIVE (JIANGYIN) ELECTRONICS CO., LTD.**, Jiangyin, Jiangsu (CN)

U.S. PATENT DOCUMENTS

4,243,114 A *	1/1981	Brouwer	177/210 C
4,526,246 A *	7/1985	Patoray	177/179
D355,139 S *	2/1995	Weirsmann	D10/91
D425,807 S *	5/2000	Sato	D10/92
D596,518 S *	7/2009	Kesselman	D10/91

(72) Inventor: **Yun Pan**, Shenzhen (CN)

* cited by examiner

(73) Assignee: **INNOVATIVE (JIANGYIN) ELECTRONICS CO., LTD.**, Jiangyin (CN)

Primary Examiner — Antoine D Davis

(74) *Attorney, Agent, or Firm* — Hamre, Schumann, Mueller & Larson, P.C.

(**) Term: **14 Years**

(57) **CLAIM**

(21) Appl. No.: **29/476,435**

The ornamental design for a postal scale, as shown and described.

(22) Filed: **Dec. 13, 2013**

DESCRIPTION

(51) **LOC (10) Cl.** **10-04**

(52) **U.S. Cl.**

USPC **D10/91**

(58) **Field of Classification Search**

USPC D10/91, 94

CPC G01G 3/00-3/18; G01G 7/00-7/06;

G01G 5/00-5/06; G01G 1/00-1/42; G01G

9/00-9/005; G01G 11/00-11/20; G01G

13/00-13/34; G01G 15/00-15/047; G01G

17/00-17/08

FIG. 1 is a front perspective view of a postal scale showing our new design;

FIG. 2 is a front elevational view thereof;

FIG. 3 is a rear elevational view thereof;

FIG. 4 is a left side elevational view thereof;

FIG. 5 is a right side elevational view thereof;

FIG. 6 is a top plan view thereof; and

FIG. 7 is a bottom plan view thereof; and,

FIG. 8 is a view of a postal scale in use.

The broken lines illustrate portions of the article and form no part of the claimed design.

See application file for complete search history.

1 Claim, 7 Drawing Sheets

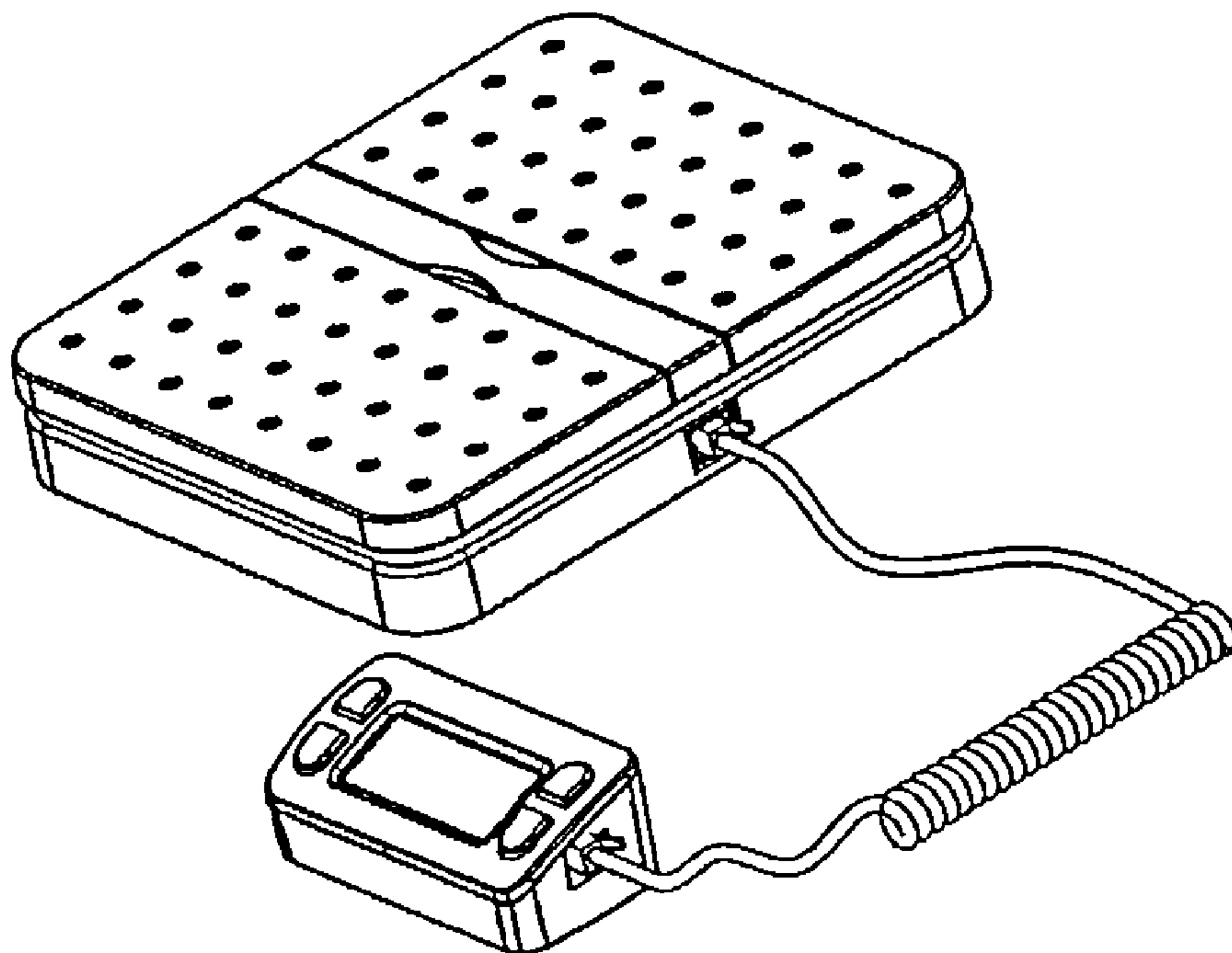

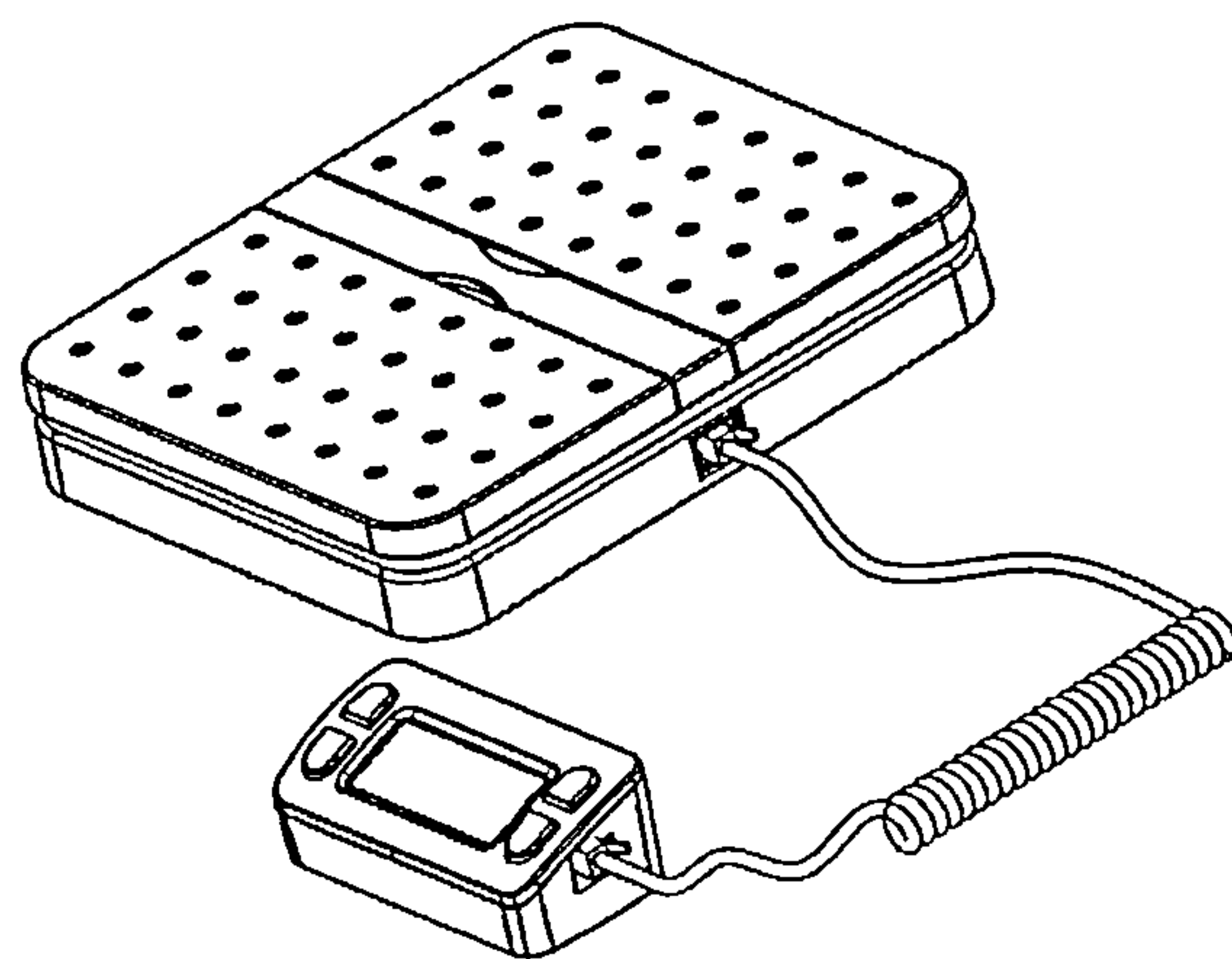

FIG.1

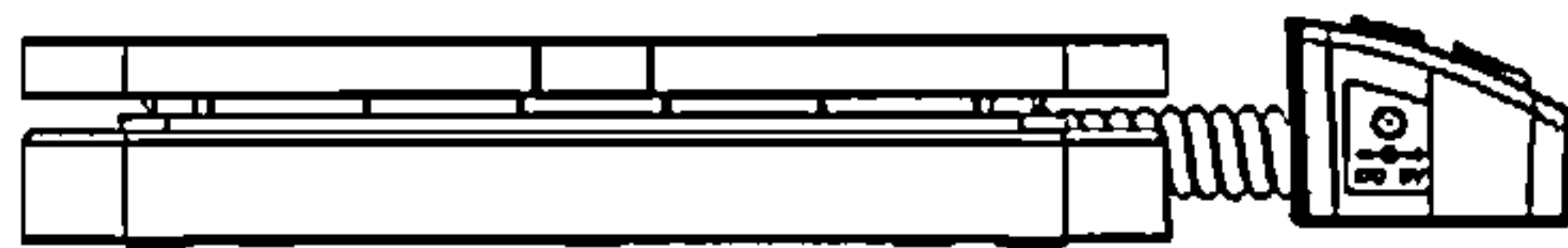

FIG.2

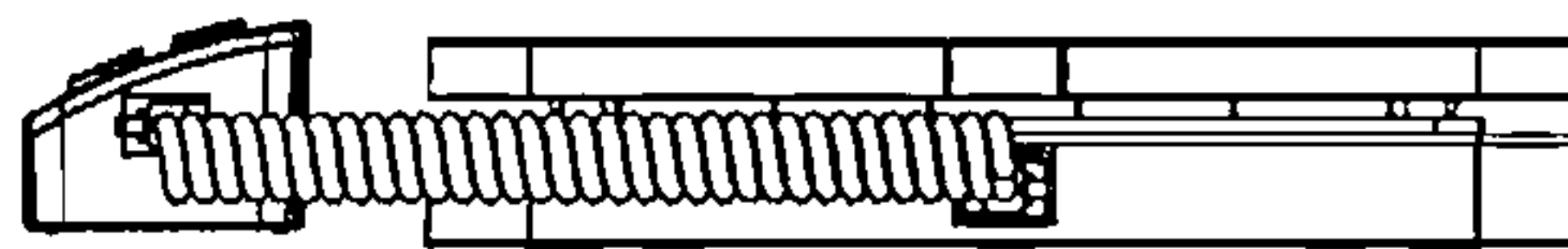

FIG.3

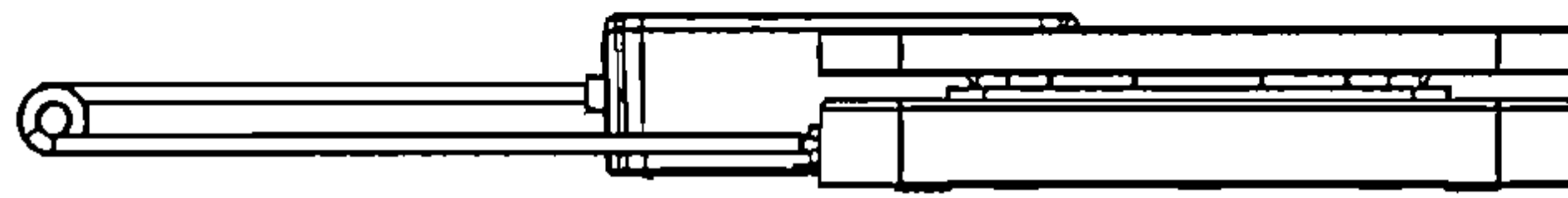

FIG. 4

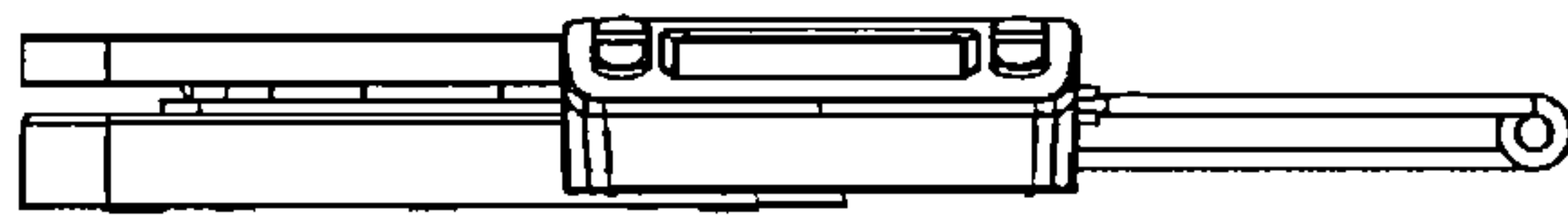

FIG. 5

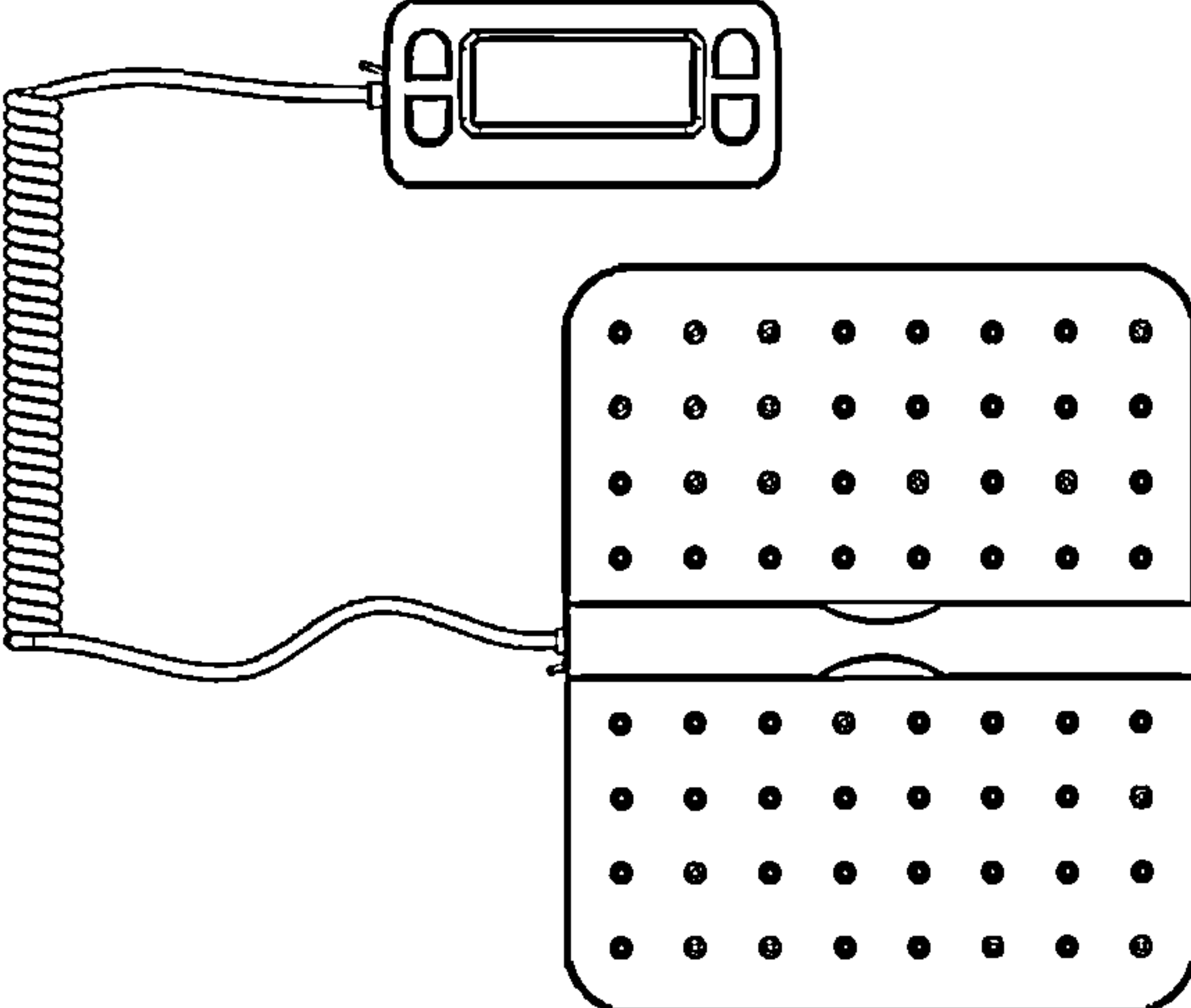

FIG.6

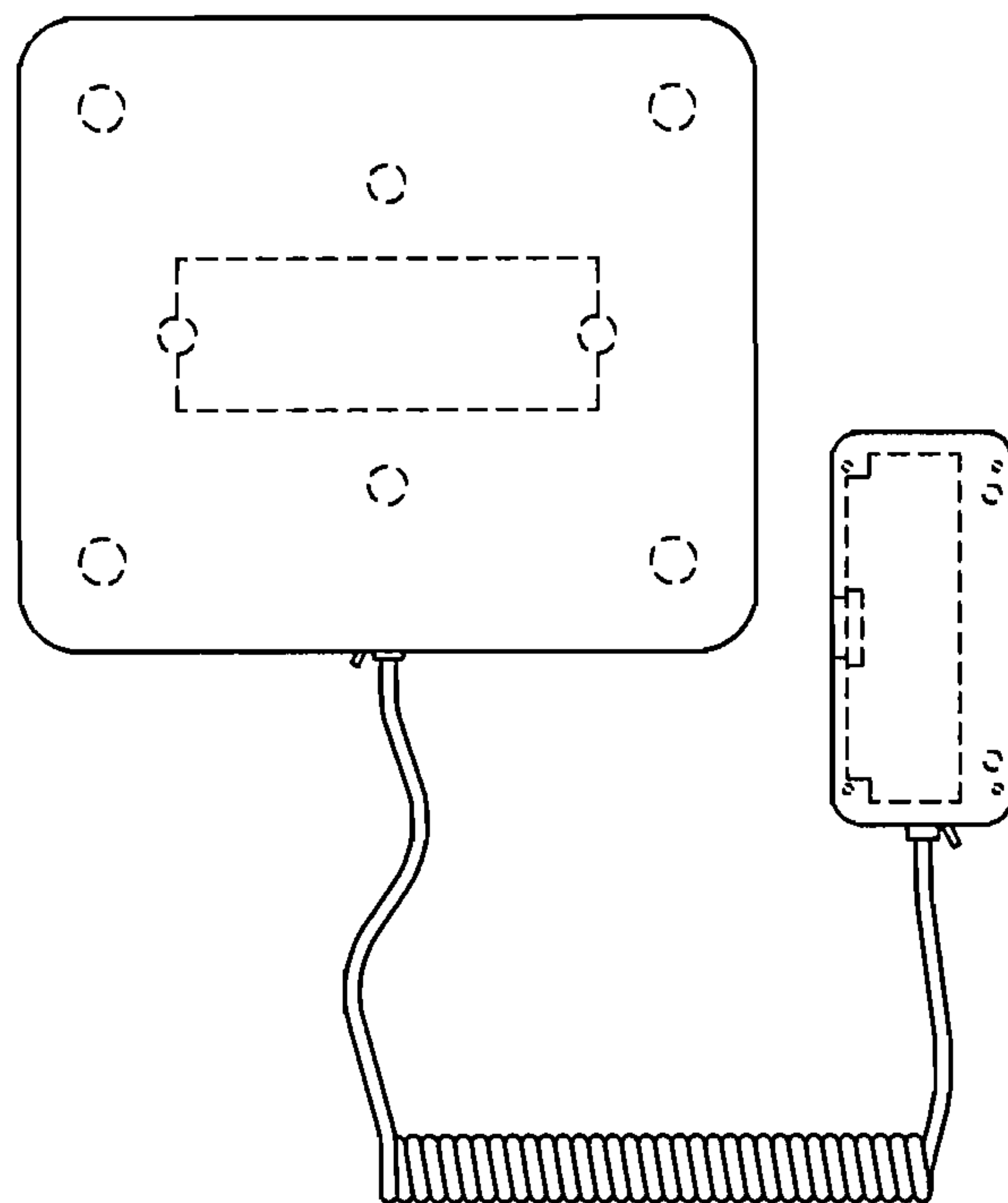

FIG. 7

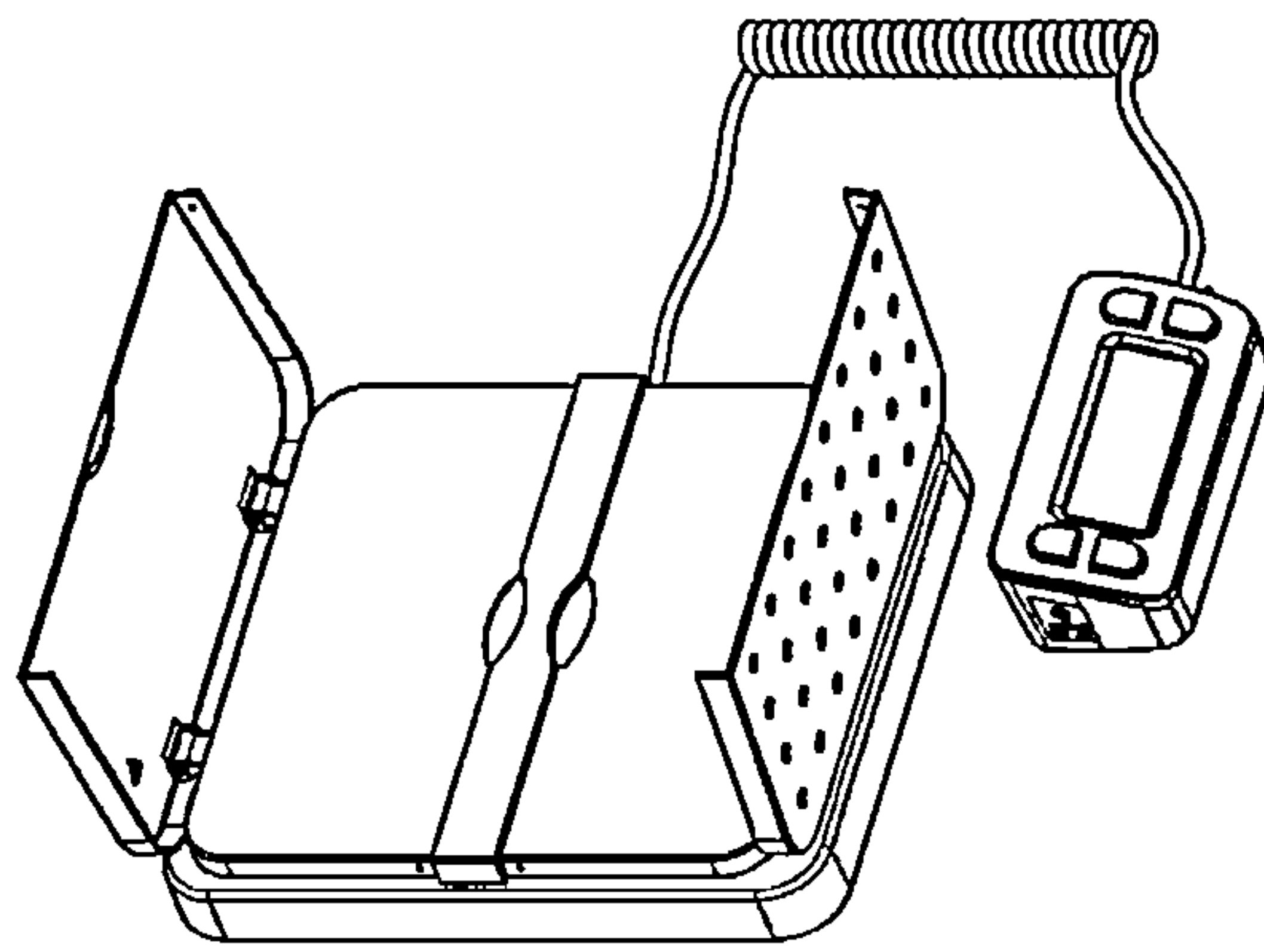

FIG.8