



US00D742245S

(12) **United States Design Patent**
Monforton et al.

(10) **Patent No.:** **US D742,245 S**

(45) **Date of Patent:** **** Nov. 3, 2015**

(54) **EXPANDED MICROWAVE FOODSTUFF PACKAGE**

(74) *Attorney, Agent, or Firm* — Kevin W. Raasch; Gregory P. Kaihoi

(71) Applicant: **General Mills, Inc.**, Minneapolis, MN (US)

(57) **CLAIM**

The ornamental design for an expanded microwave foodstuff package, as shown and described.

(72) Inventors: **Randal Joseph Monforton**, Minnetrista, MN (US); **Donald Stephen Mathers**, Plymouth, MN (US)

DESCRIPTION

(73) Assignee: **General Mills, Inc.**, Minneapolis, MN (US)

FIG. 1 is a perspective view of one embodiment of an expanded microwave foodstuff package of the claimed design;

(**) Term: **14 Years**

FIG. 2 is a front view of the package of FIG. 1;

(21) Appl. No.: **29/477,546**

FIG. 3 is a rear view of the package of FIG. 1;

(22) Filed: **Dec. 23, 2013**

FIG. 4 is a right side view of the package of FIG. 1;

(51) **LOC (10) Cl.** **09-05**

FIG. 5 is a left side view of the package of FIG. 1;

(52) **U.S. Cl.**

FIG. 6 is a top view of the package of FIG. 1;

USPC **D9/707**

FIG. 7 is a bottom view of the package of FIG. 1;

(58) **Field of Classification Search**

FIG. 8 is a perspective view of another embodiment of an expanded microwave foodstuff package of the claimed design;

USPC D9/702–714, 720–722, 414, 434–435, D9/696, 716, 771, 447, 522, 571–575, 682, D9/738–747, 516–517, 529–530, 547–549, D9/569, 537–538, 544, 503–505, 545; 383/6, 9, 22, 96, 61.1, 80–81, 104, 383/901, 63, 203, 107, 119, 120, 123; D24/118, 207; 222/107, 92, 206; 604/408, 410, 403; 220/495.03, 669, 220/675; 215/381–385, 12.1; D3/202, 303, D3/232, 244

FIG. 9 is a front view of the package of FIG. 8;

FIG. 10 is a rear view of the package of FIG. 8;

FIG. 11 is a right side view of the package of FIG. 8;

FIG. 12 is a left side view of the package of FIG. 8;

FIG. 13 is a top view of the package of FIG. 8;

FIG. 14 is a bottom view of the package of FIG. 8;

FIG. 15 is a perspective view of another embodiment of an expanded microwave foodstuff package of the claimed design;

FIG. 16 is a front view of the package of FIG. 15;

FIG. 17 is a rear view of the package of FIG. 15;

FIG. 18 is a right side view of the package of FIG. 15;

FIG. 19 is a left side view of the package of FIG. 15;

FIG. 20 is a top view of the package of FIG. 15; and,

FIG. 21 is a bottom view of the package of FIG. 15.

The broken line showing of portions of the expanded microwave foodstuff package is included for the purpose of illustrating unclaimed environmental structure and forms no part of the claimed design.

See application file for complete search history.

(56) **References Cited**

U.S. PATENT DOCUMENTS

4,810,844 A * 3/1989 Anderson 219/727
D393,590 S * 4/1998 Roney D9/705

(Continued)

Primary Examiner — Thomas Johannes

Assistant Examiner — Abraham Bahta

1 Claim, 20 Drawing Sheets

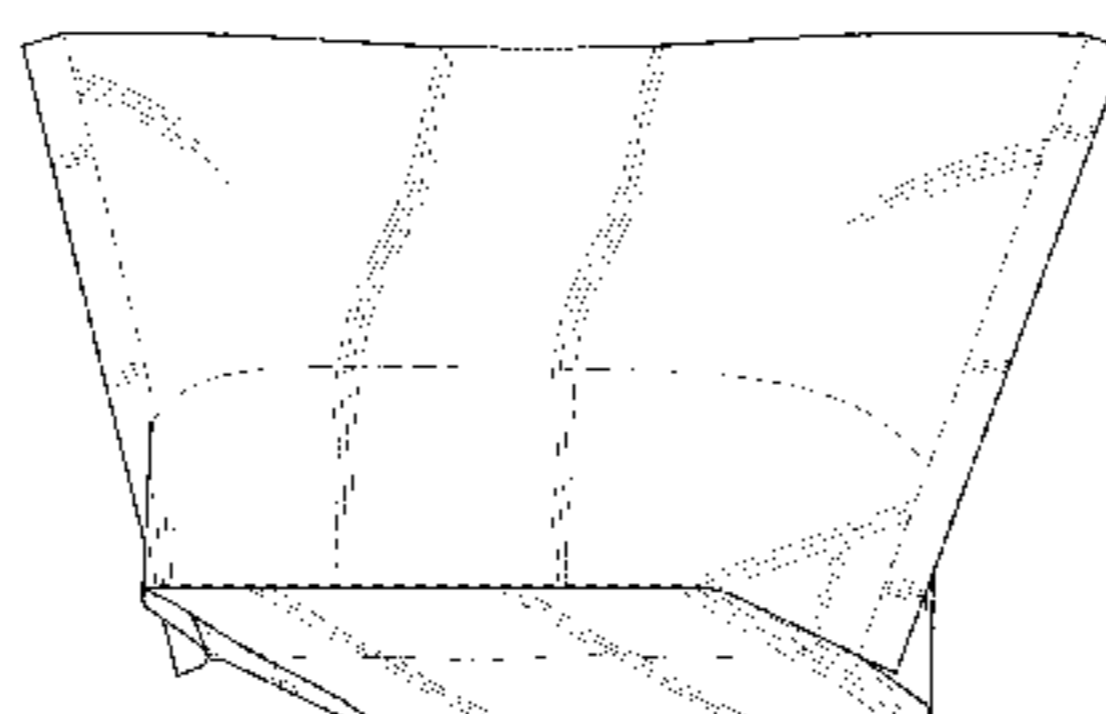
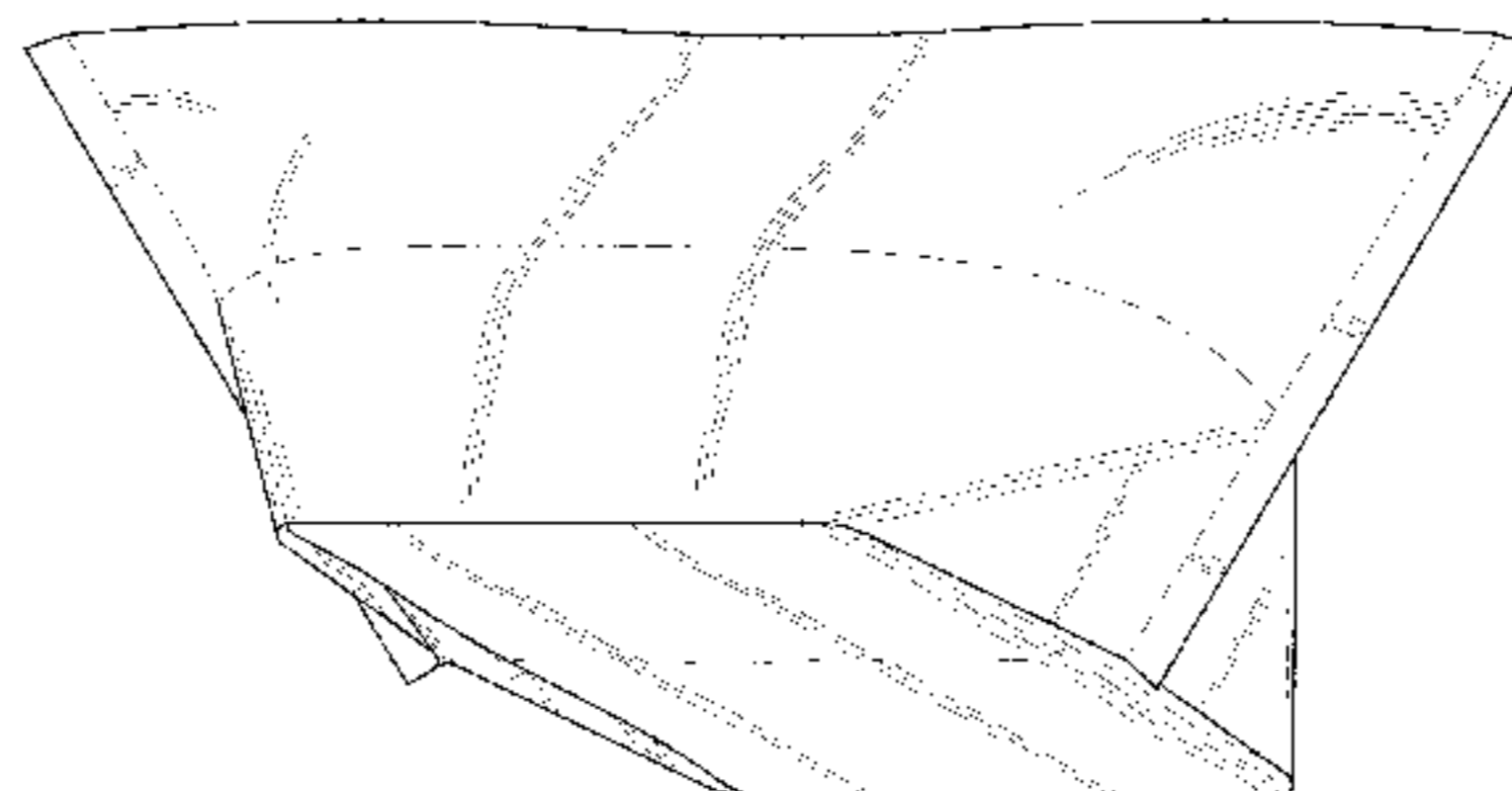

US D742,245 S

Page 2

(56)

References Cited

U.S. PATENT DOCUMENTS

D423,923 S * 5/2000 Sagel D9/707
D449,979 S * 11/2001 Planchard D9/703
D468,196 S * 1/2003 Graham D9/707
D501,410 S * 2/2005 Lin D9/707

D513,192 S * 12/2005 Lin D9/702
D552,482 S * 10/2007 Lin D9/703
D555,009 S * 11/2007 Lin D9/707
D567,668 S * 4/2008 Lin D9/707
D597,857 S * 8/2009 Lin D9/709
D602,377 S * 10/2009 Lin D9/709

* cited by examiner

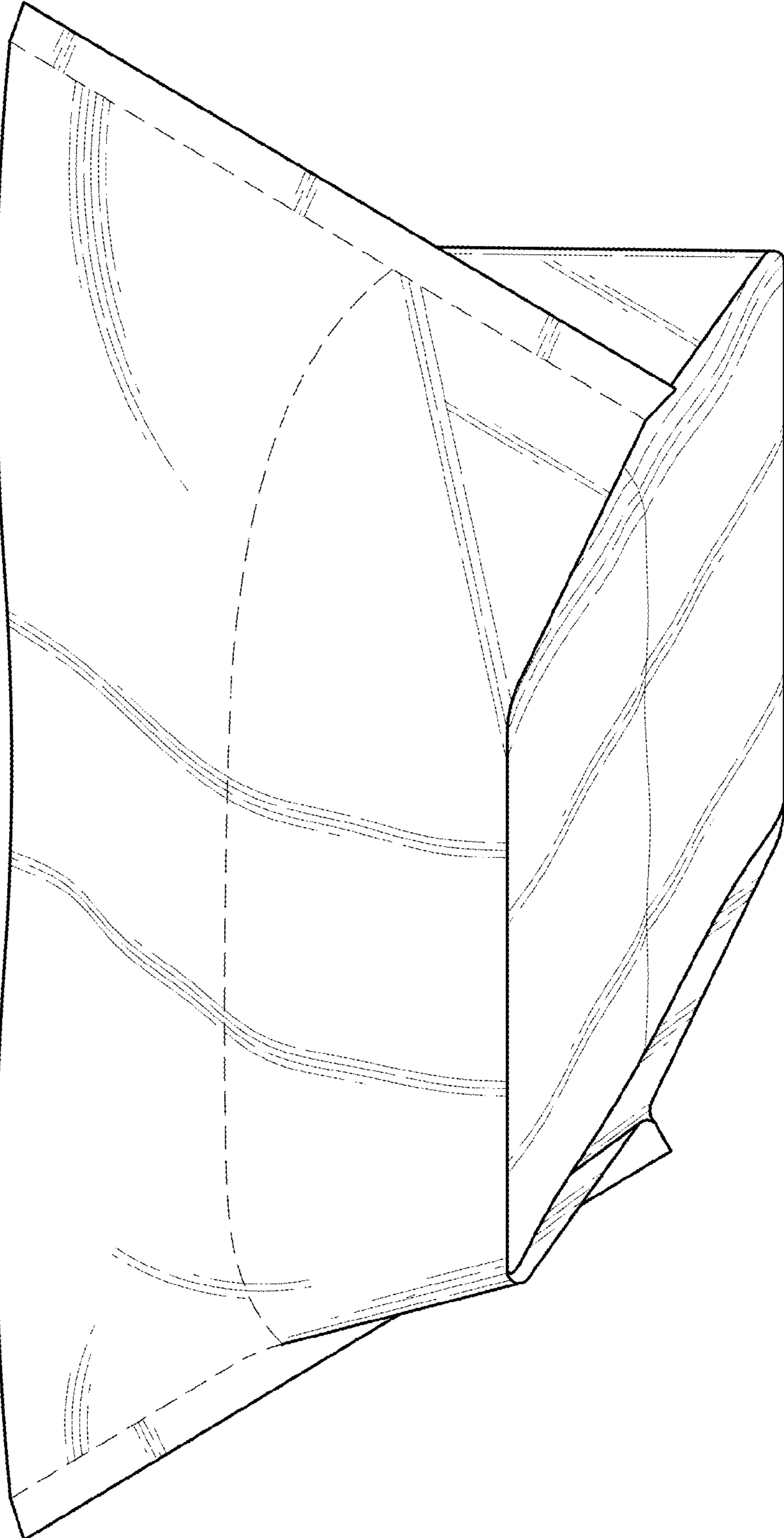

Fig. 1

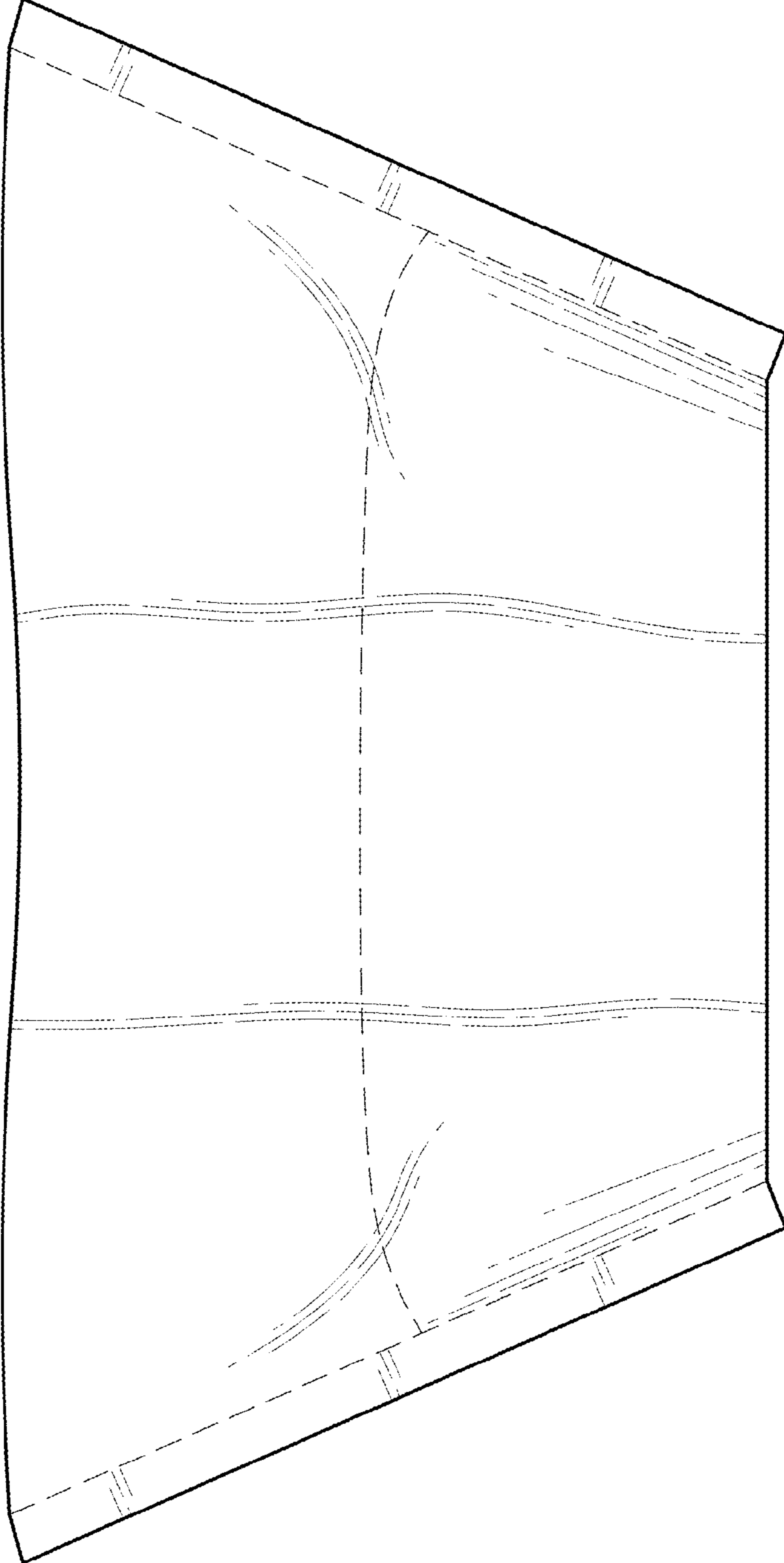

Fig. 2

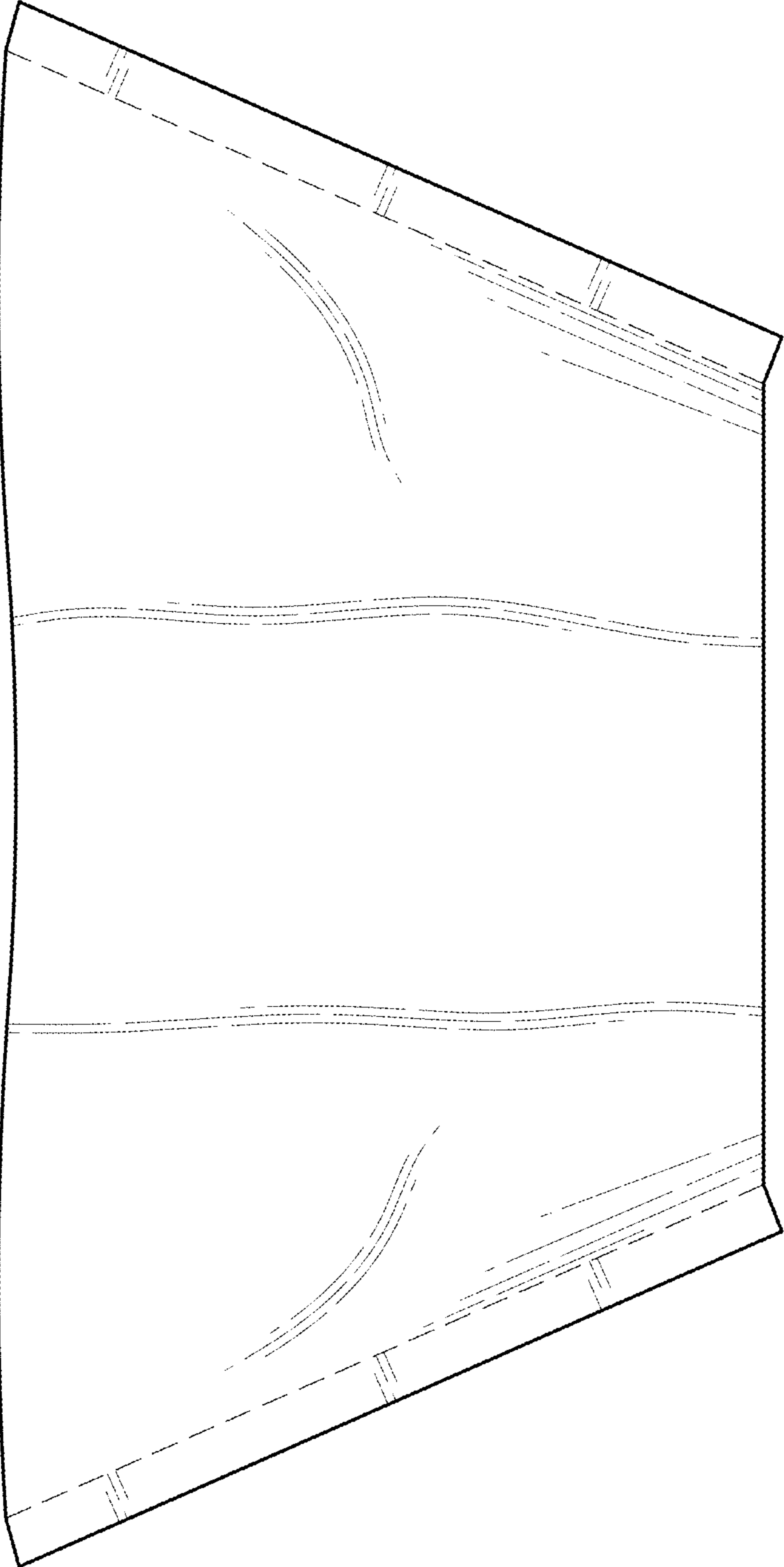

Fig. 3

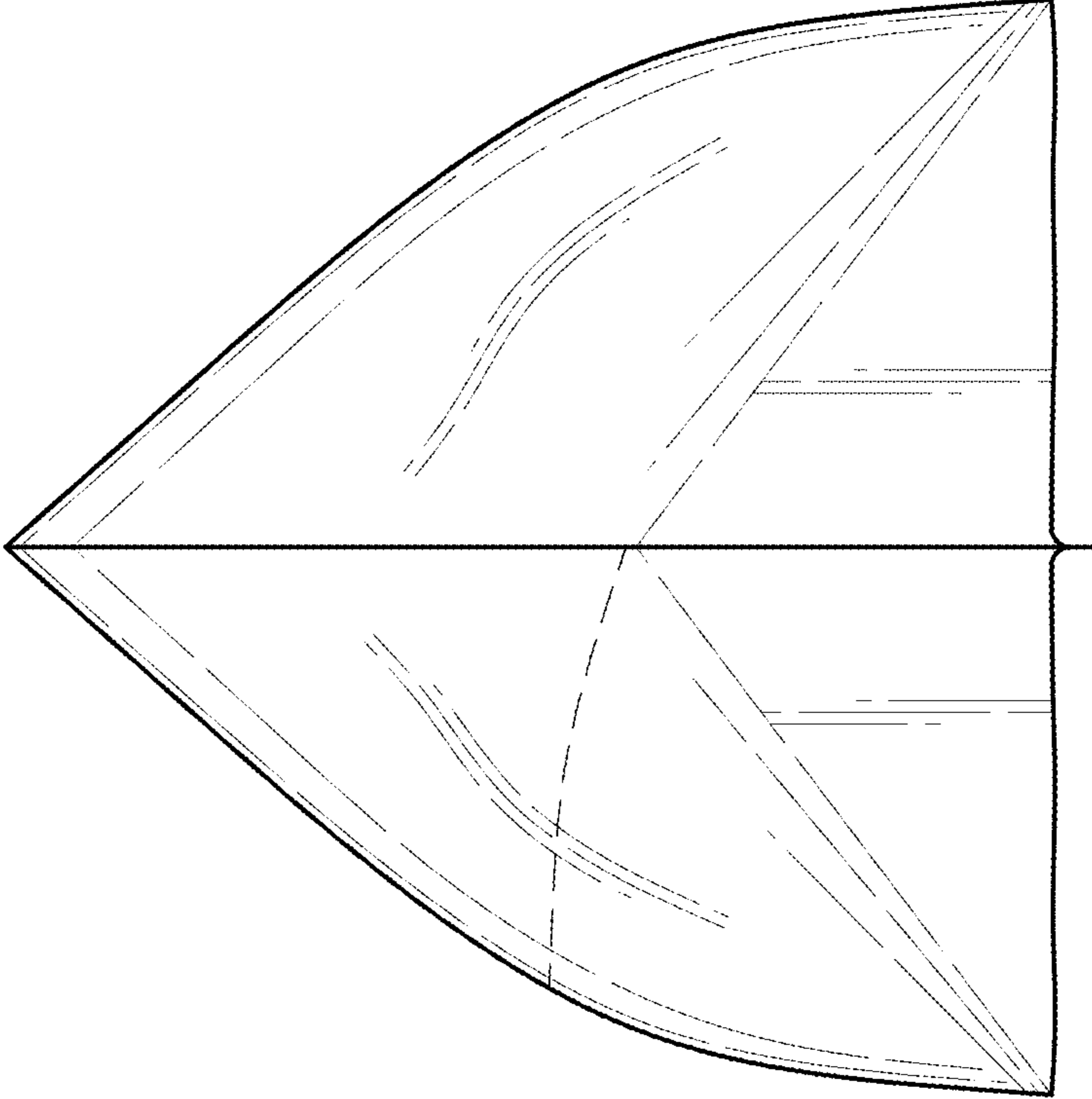

Fig. 4

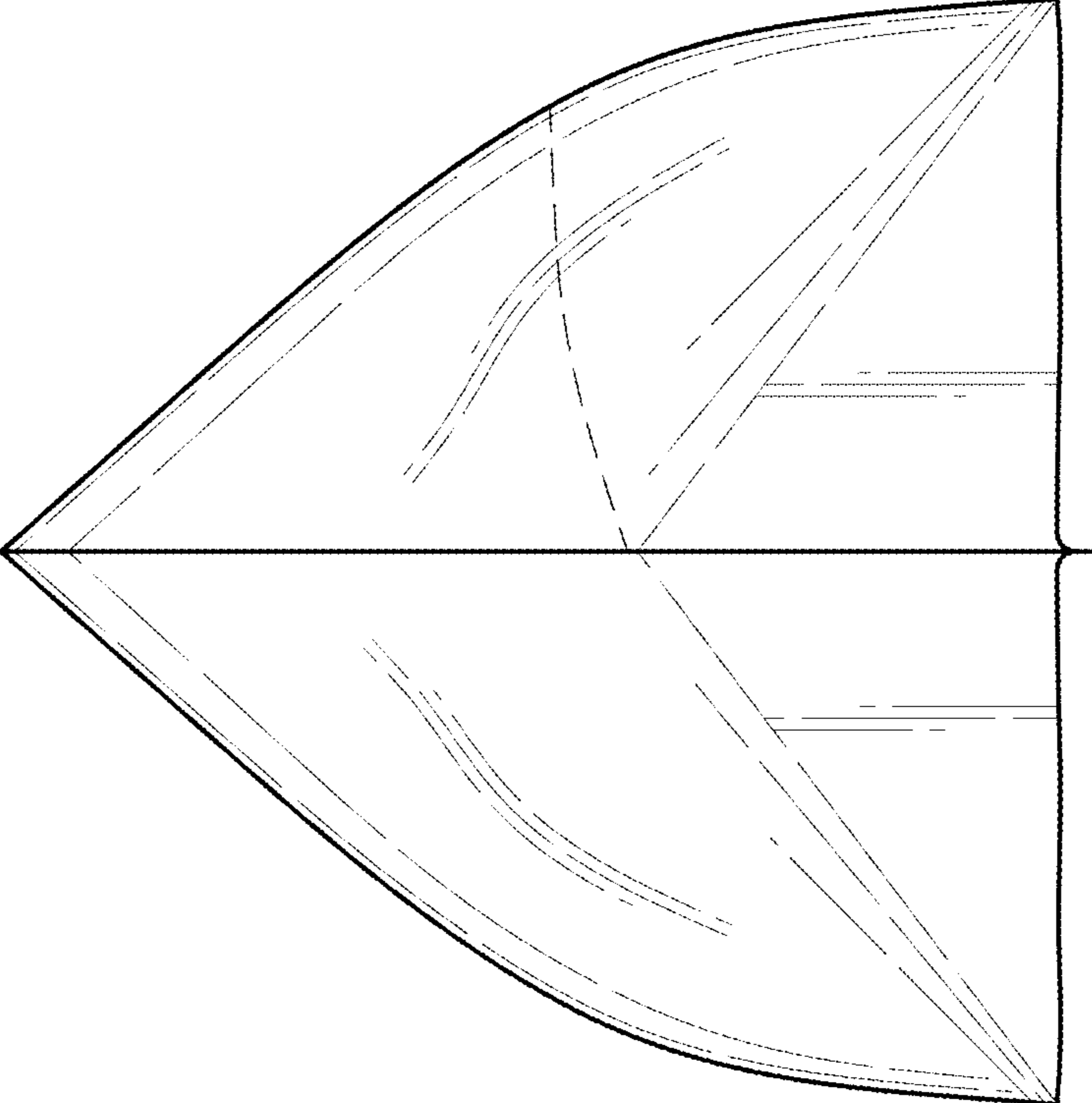

Fig. 5

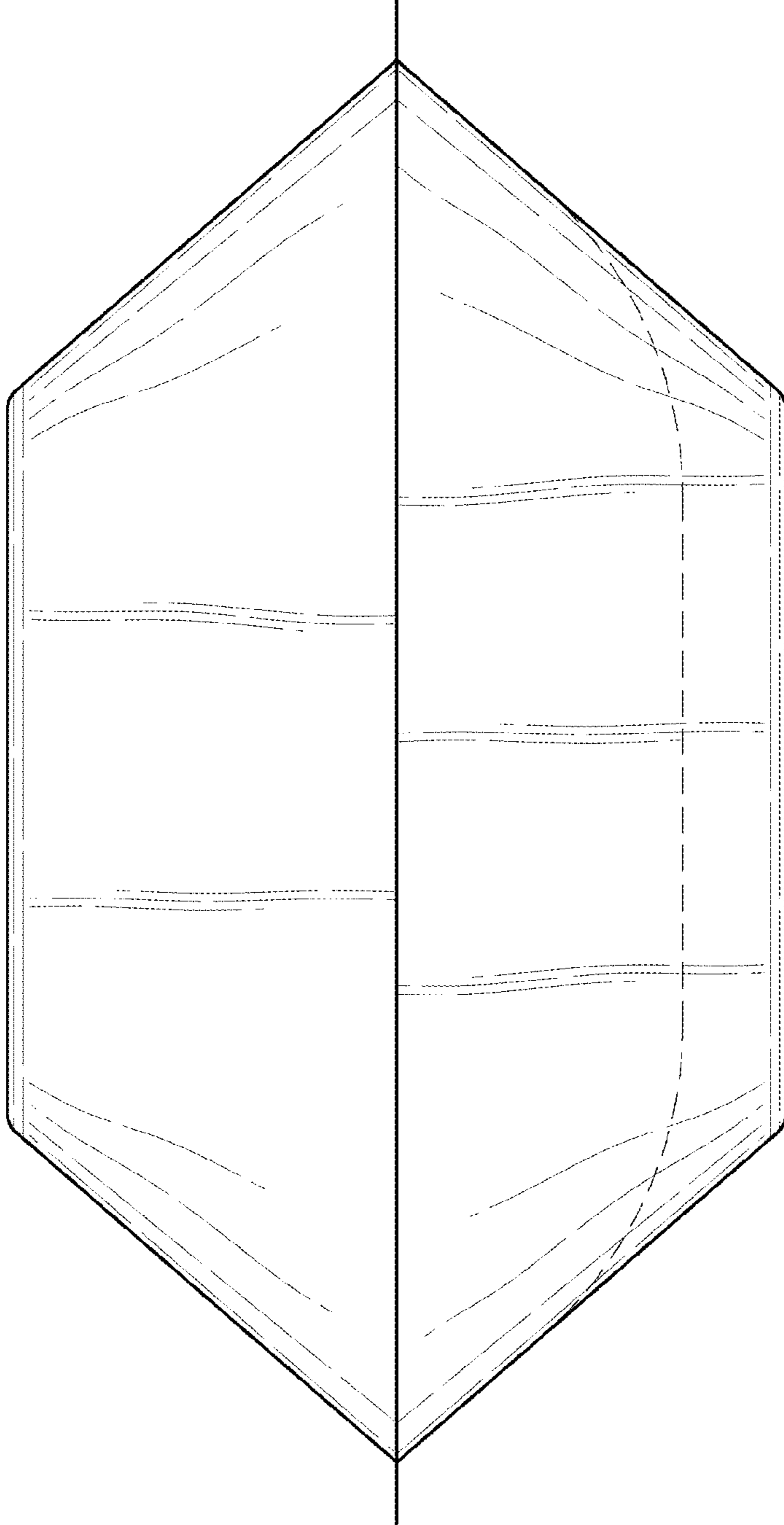

Fig. 6

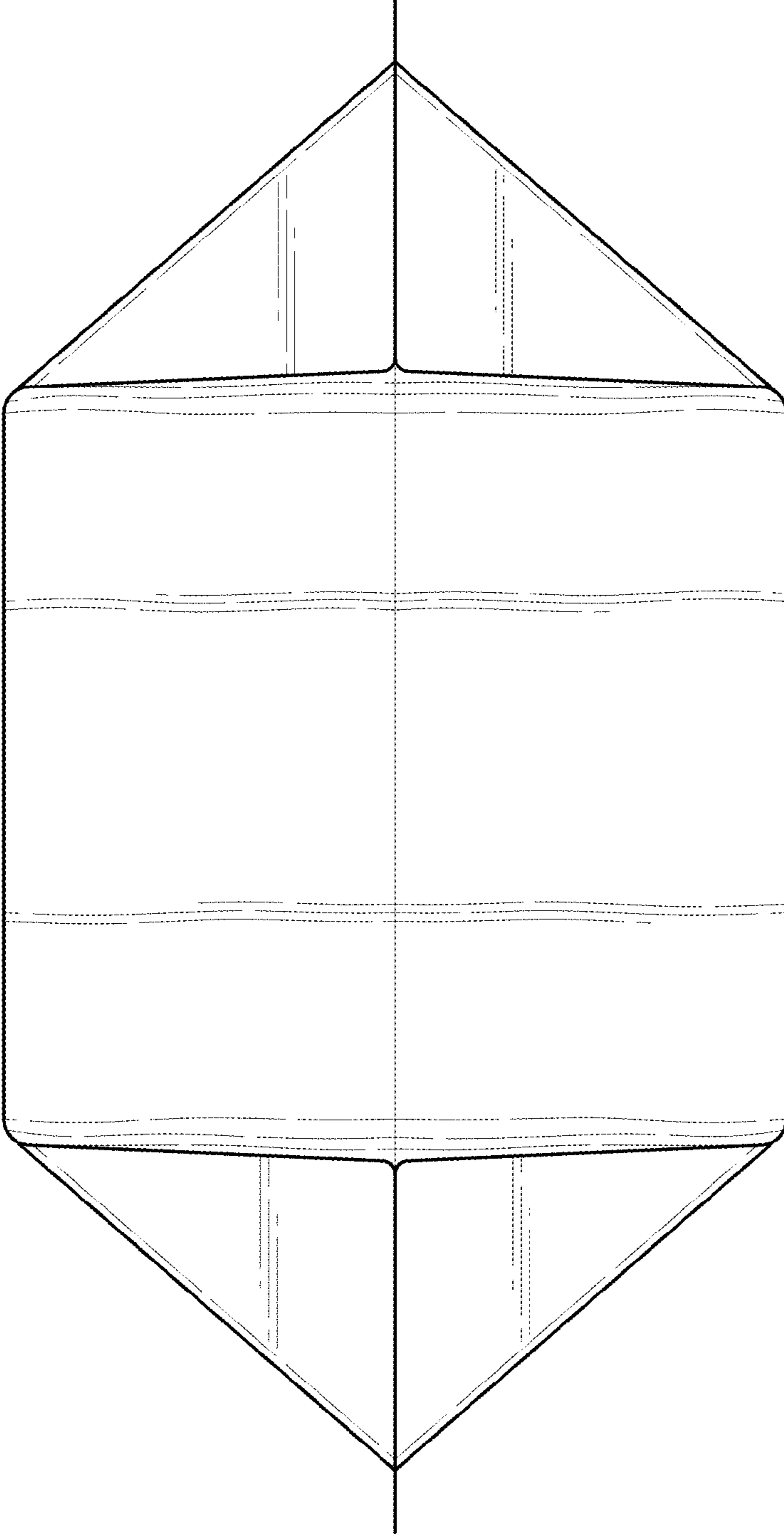

Fig. 7

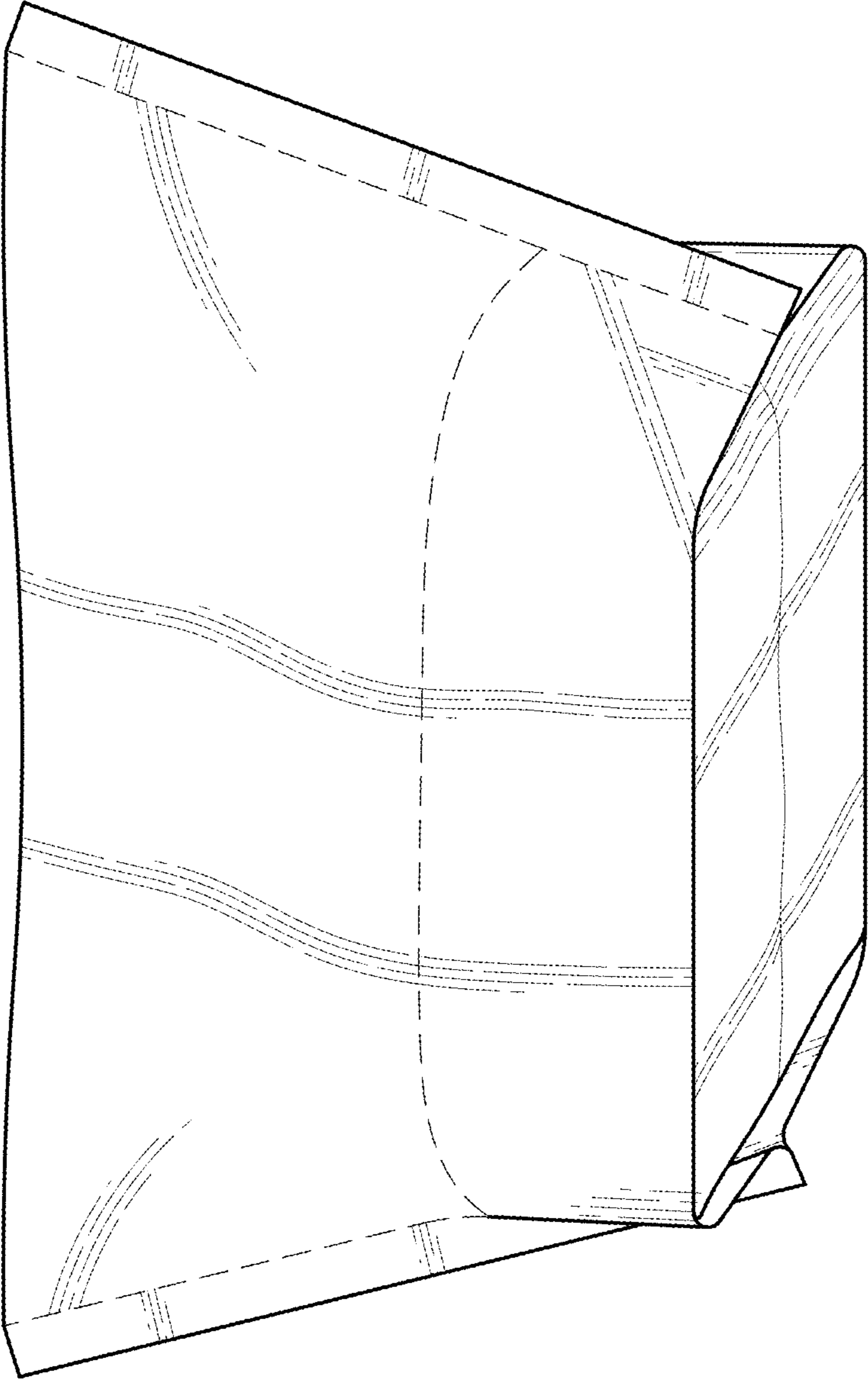

Fig. 8

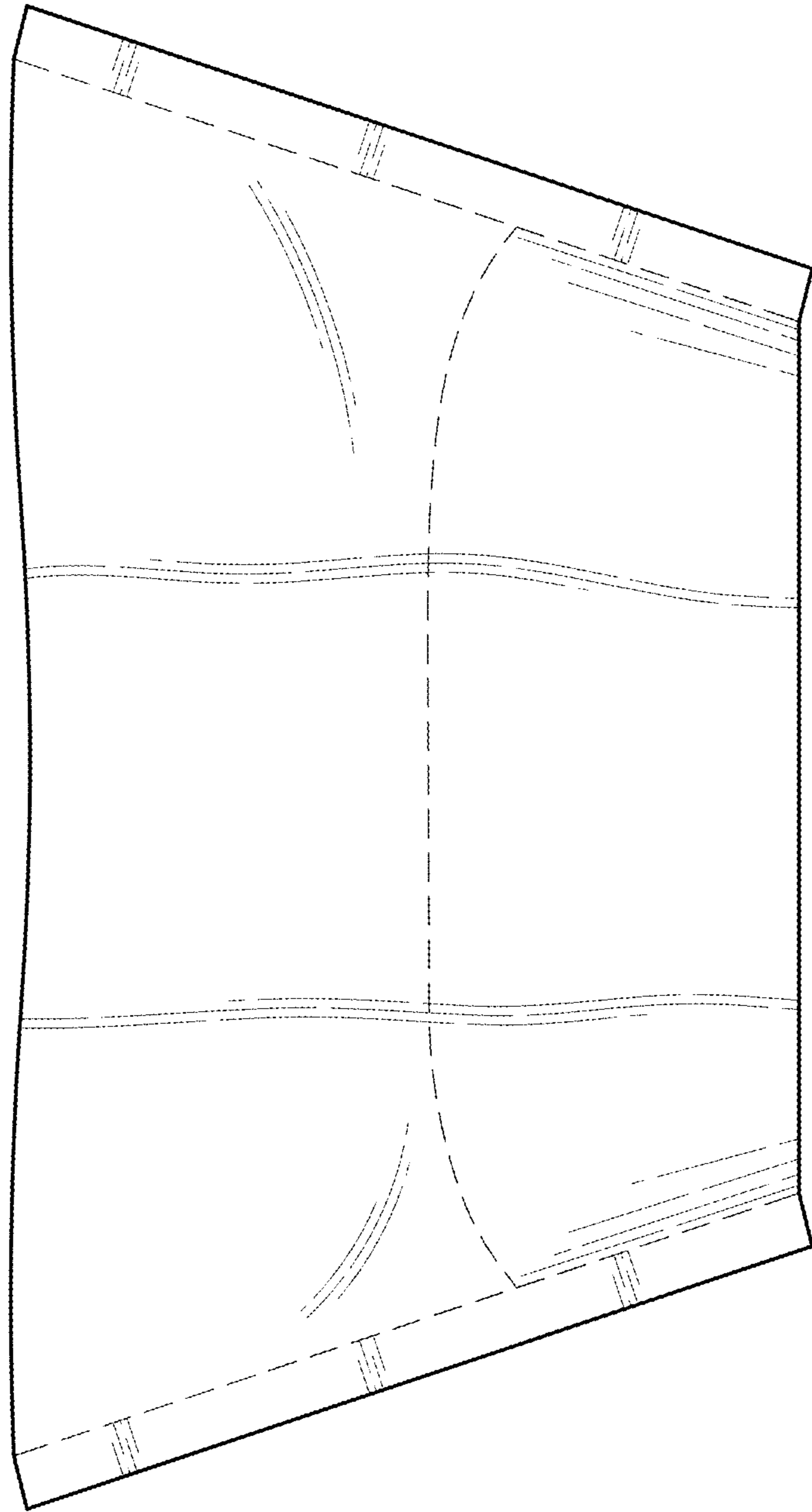

Fig. 9

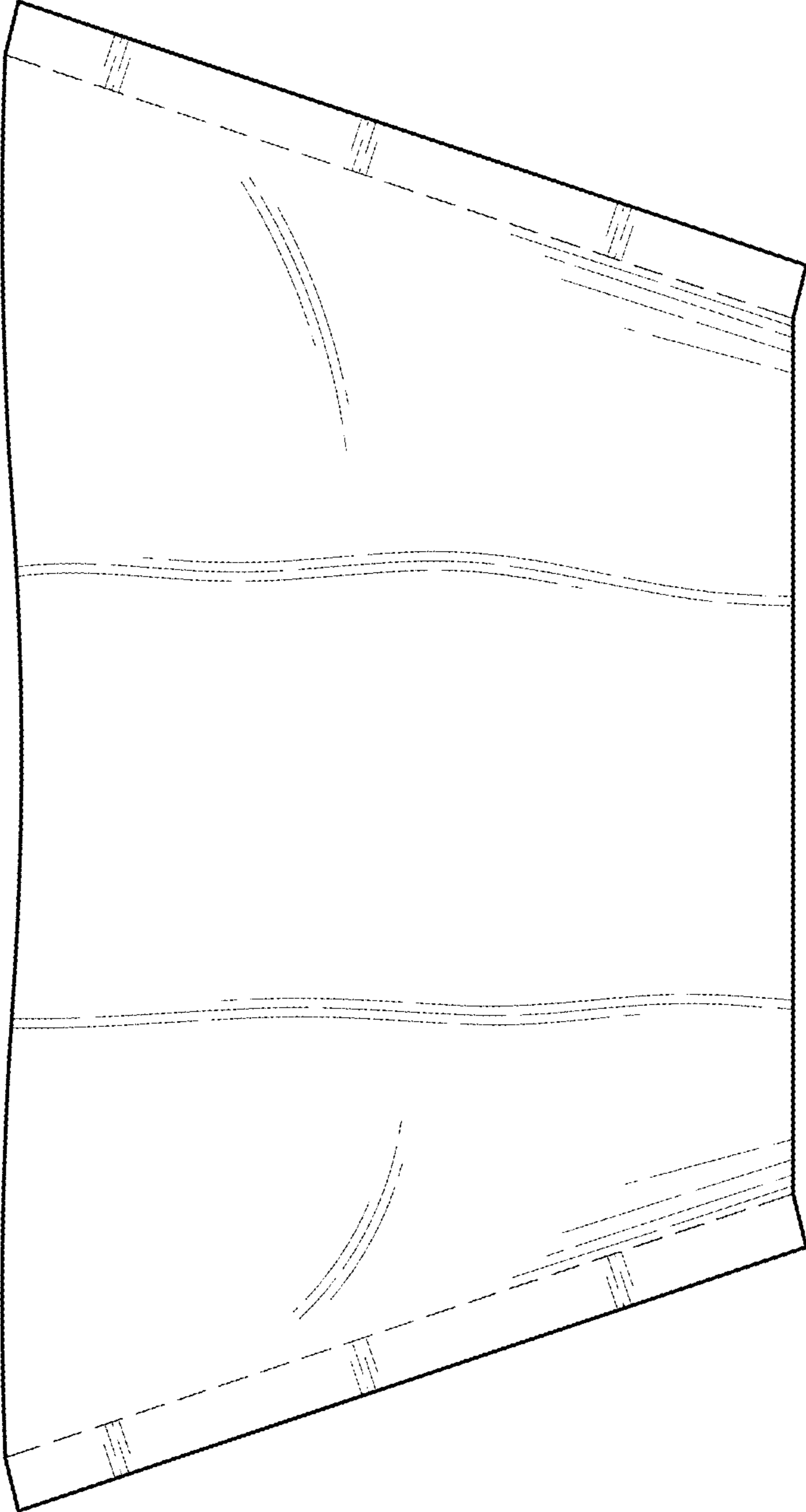

Fig. 10

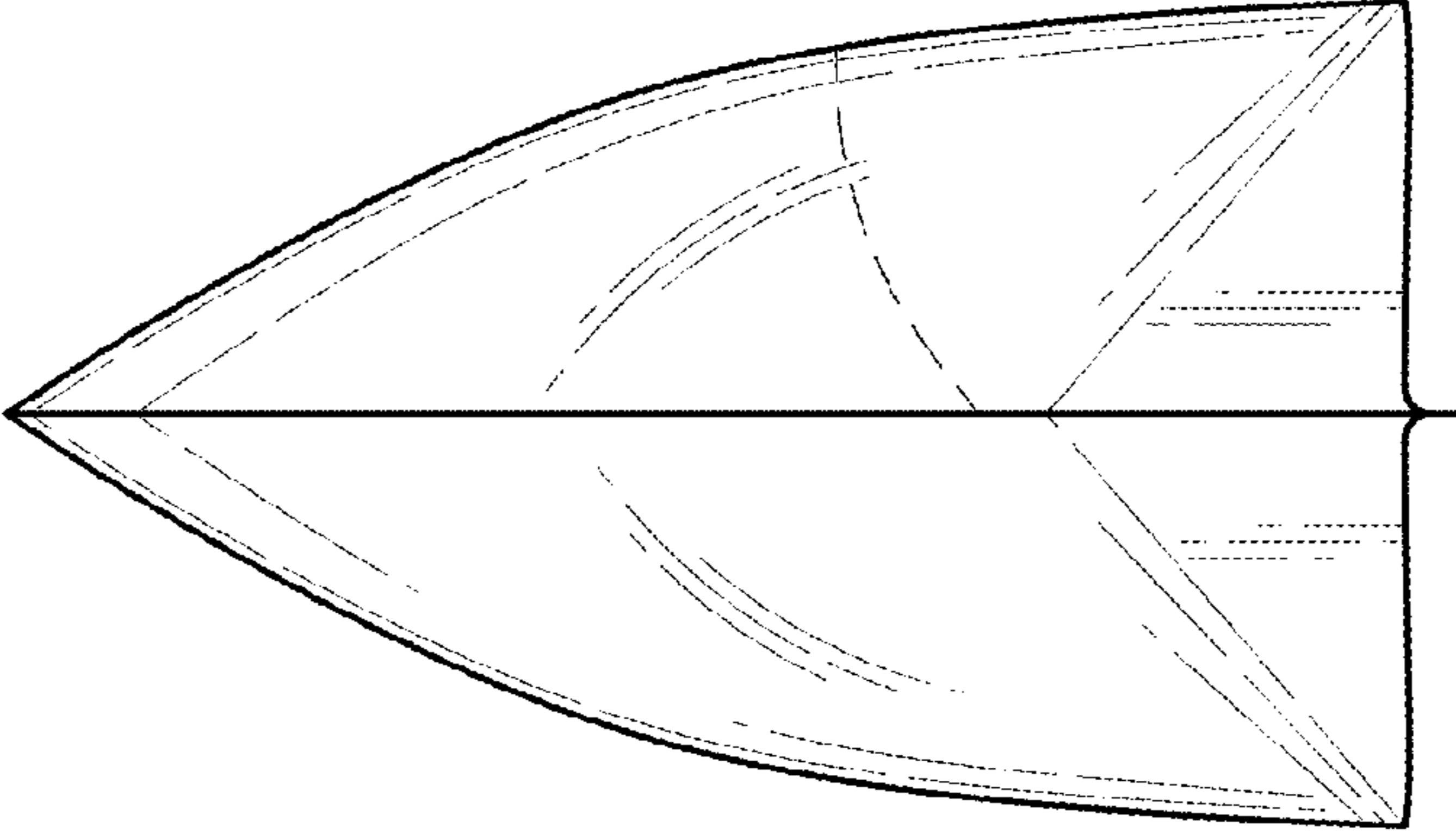

Fig. 12

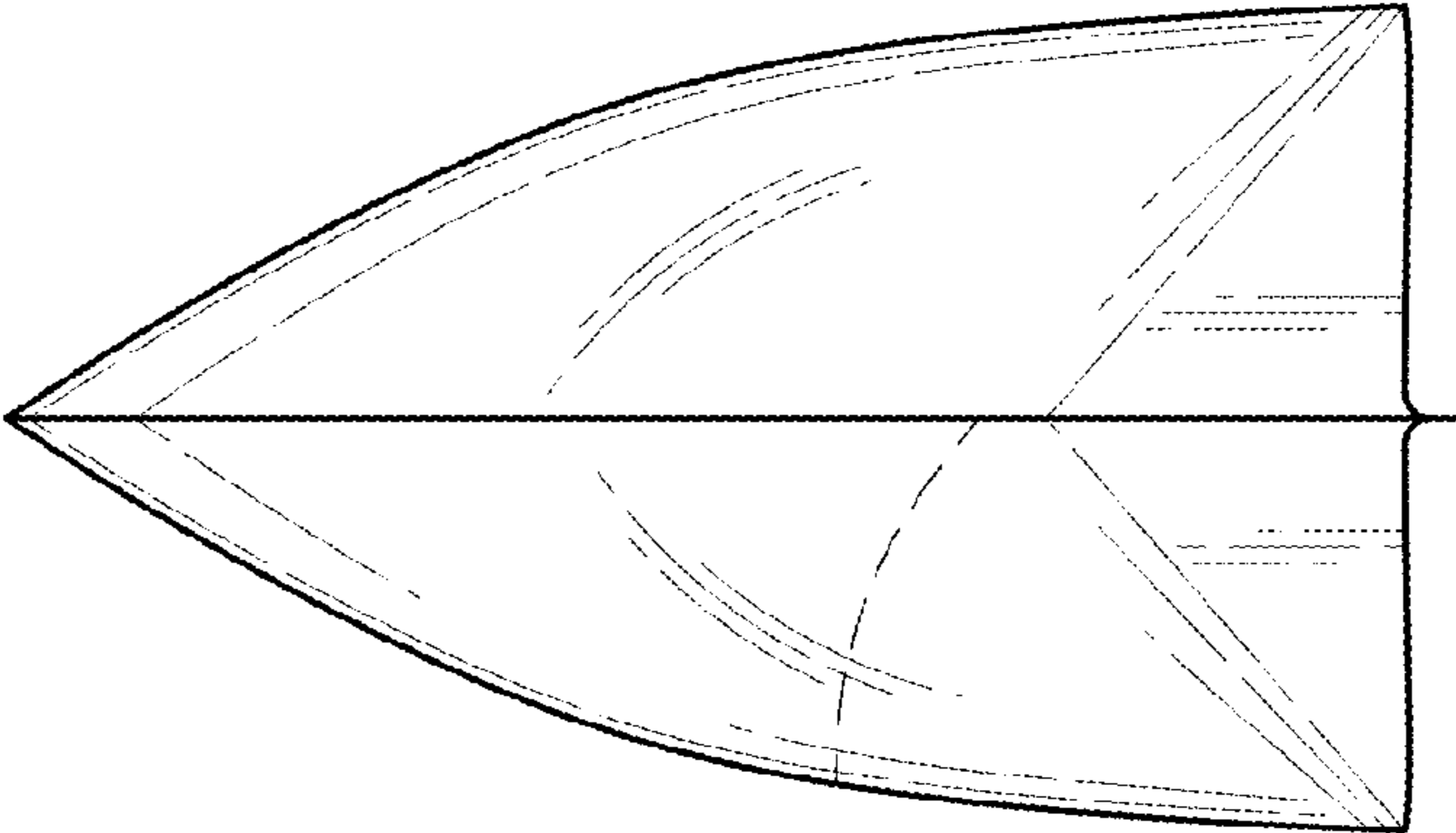

Fig. 11

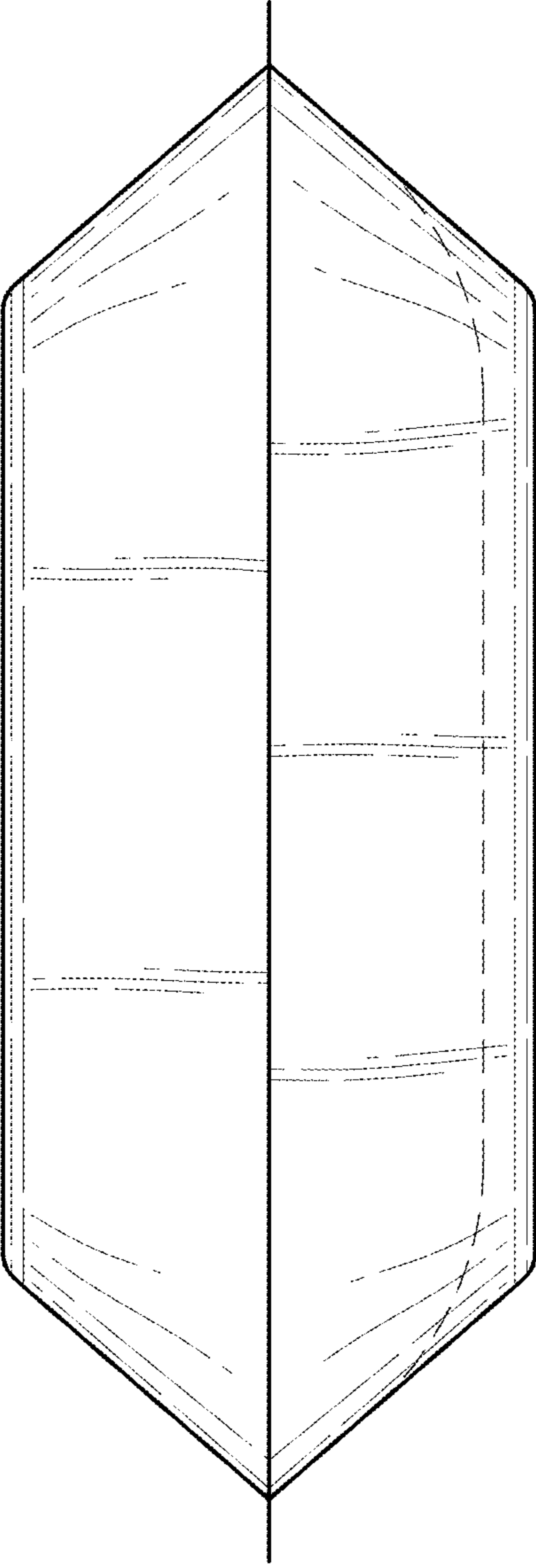

Fig. 13

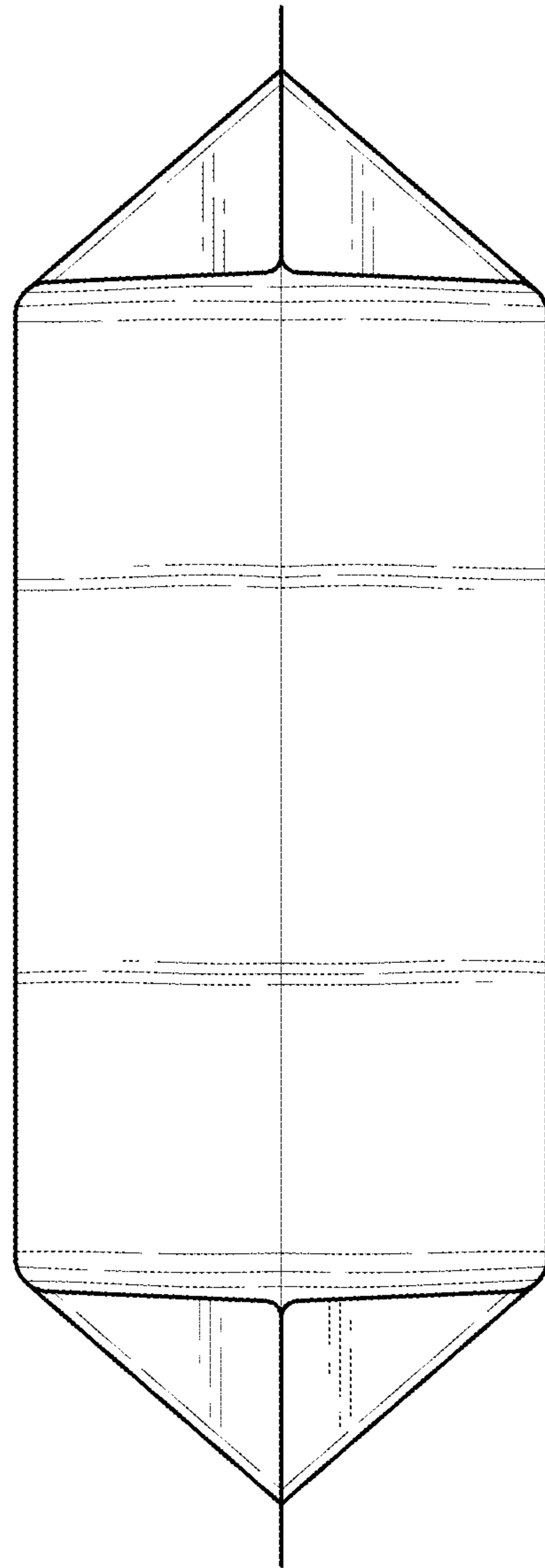

Fig. 14

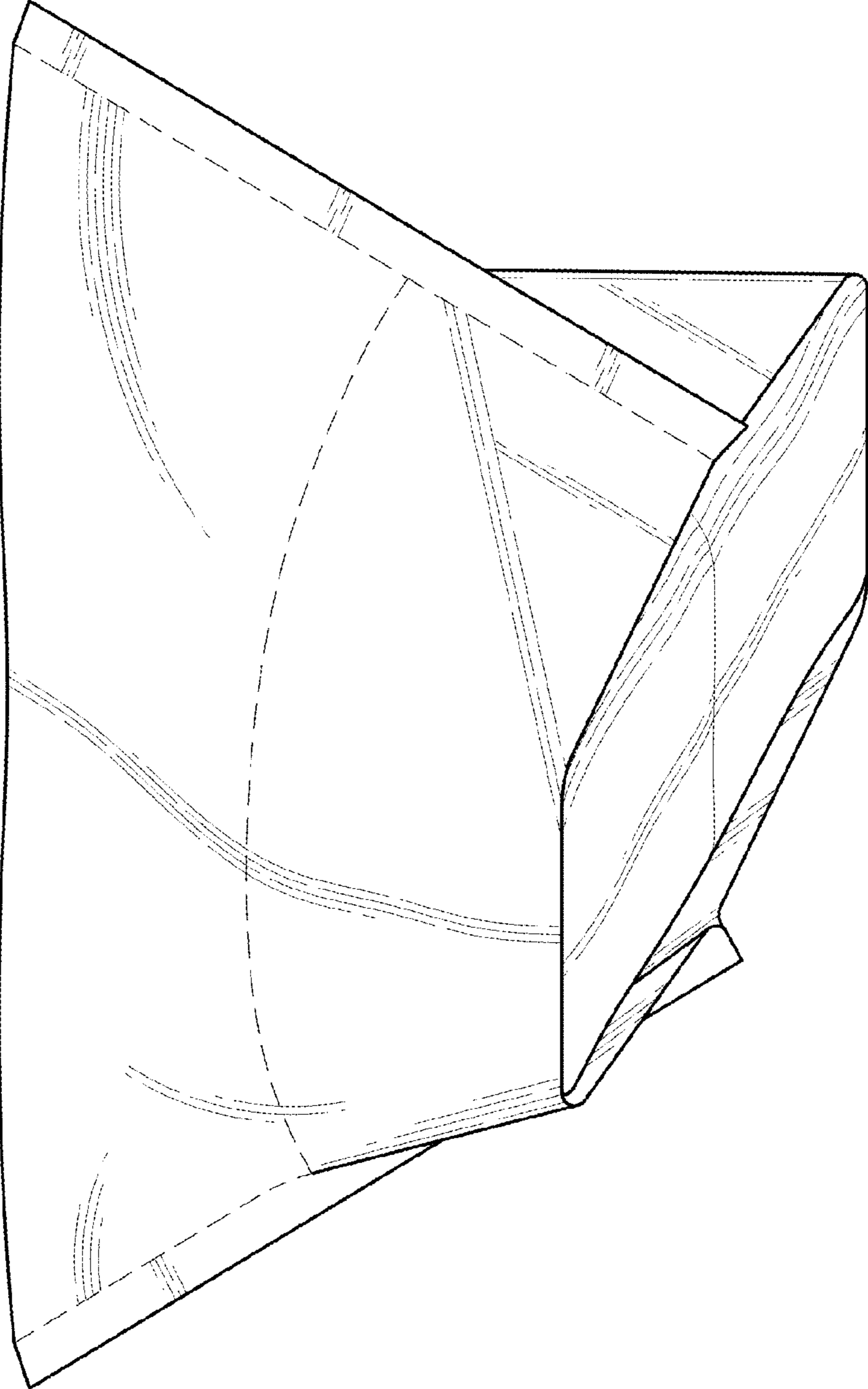

Fig. 15

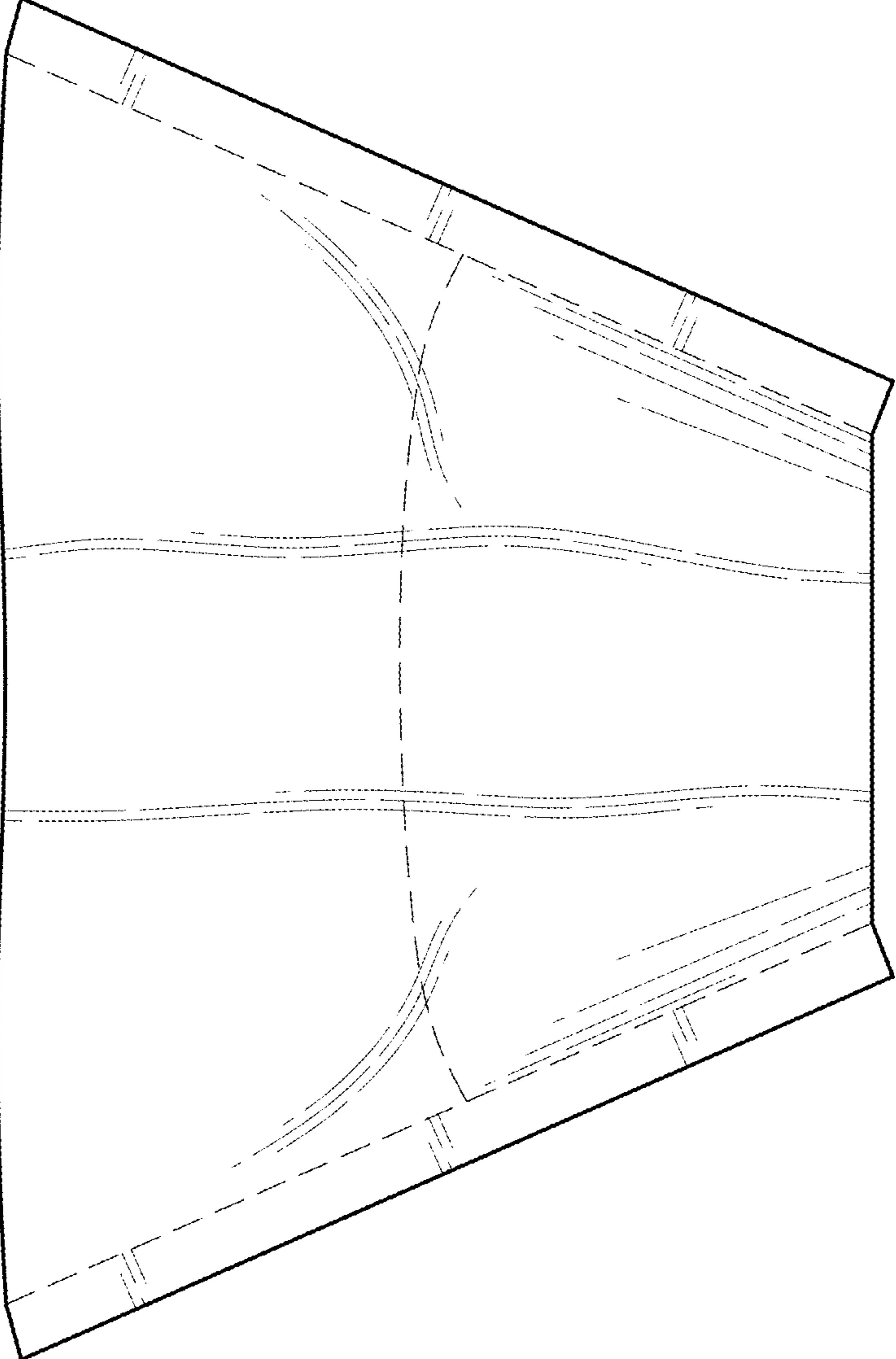

Fig. 16

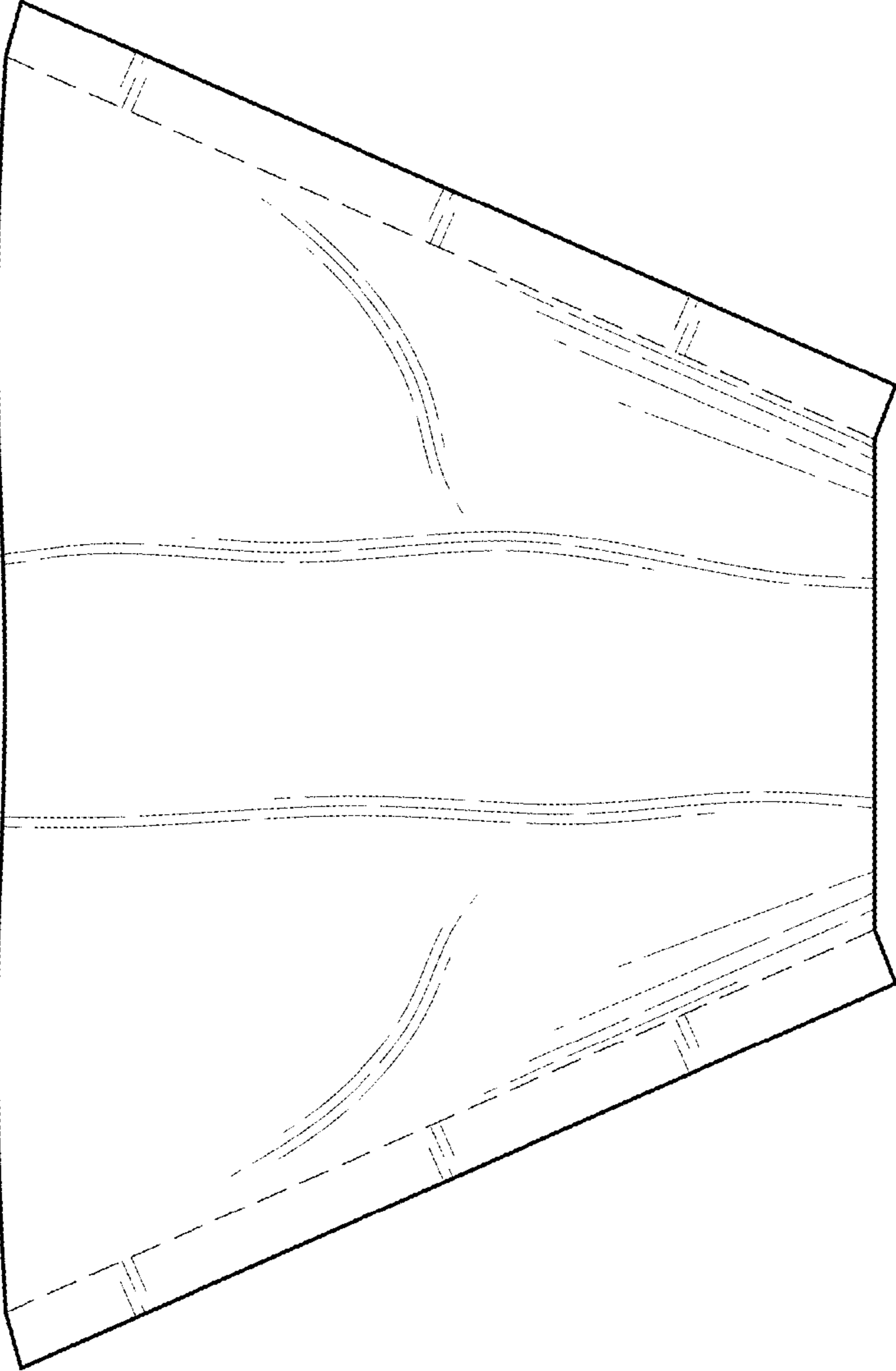

Fig. 17

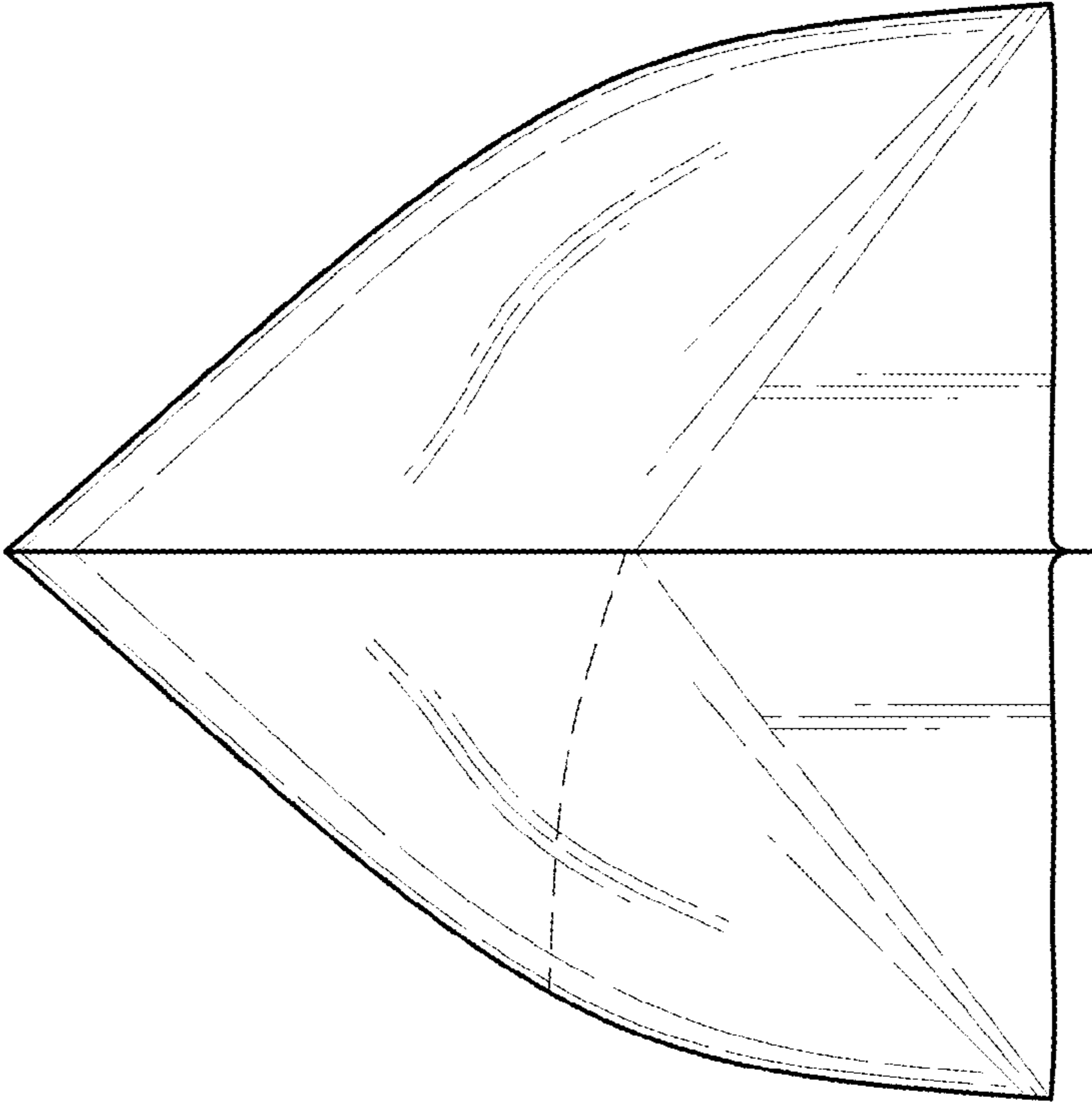

Fig. 18

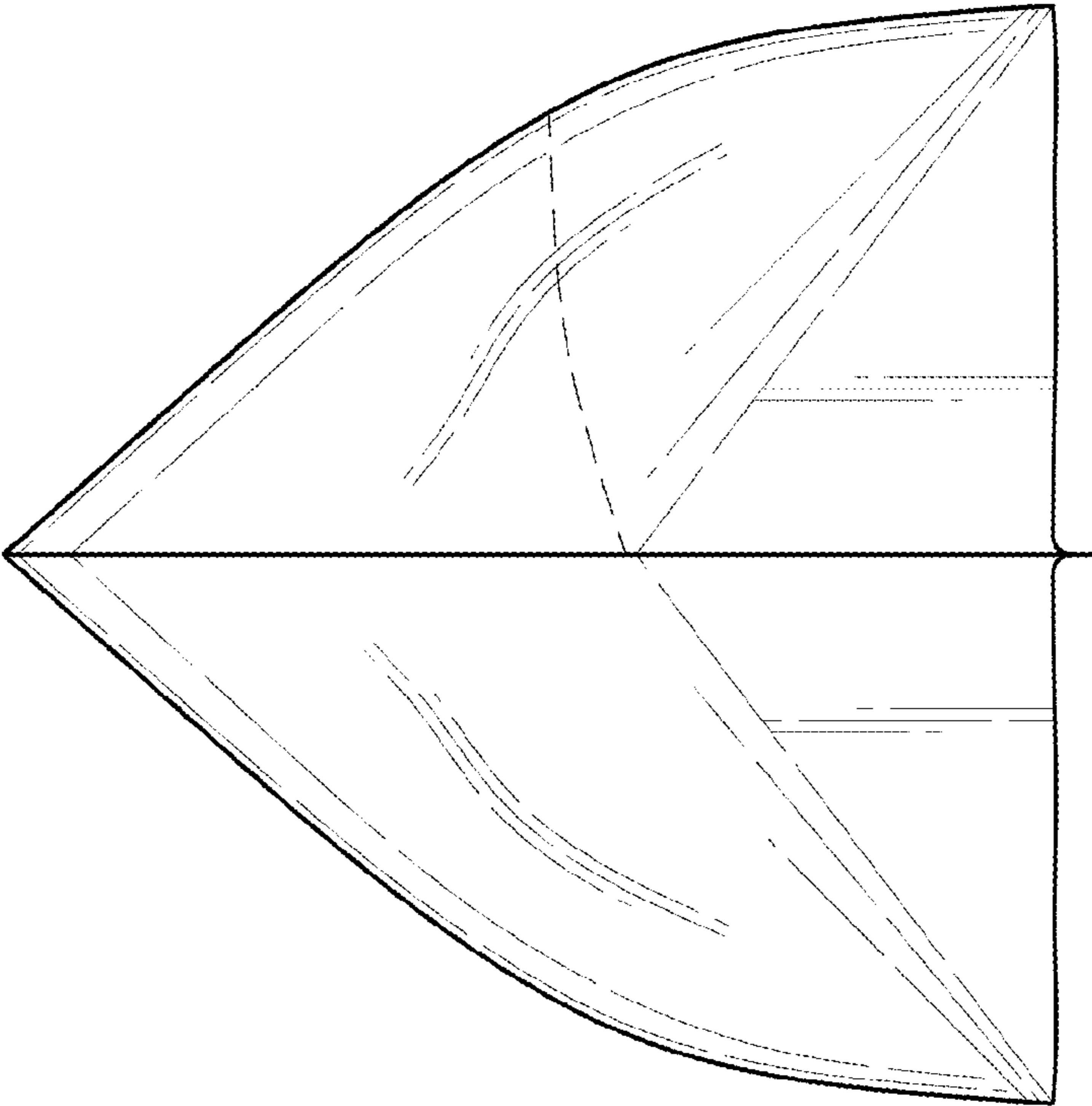

Fig. 19

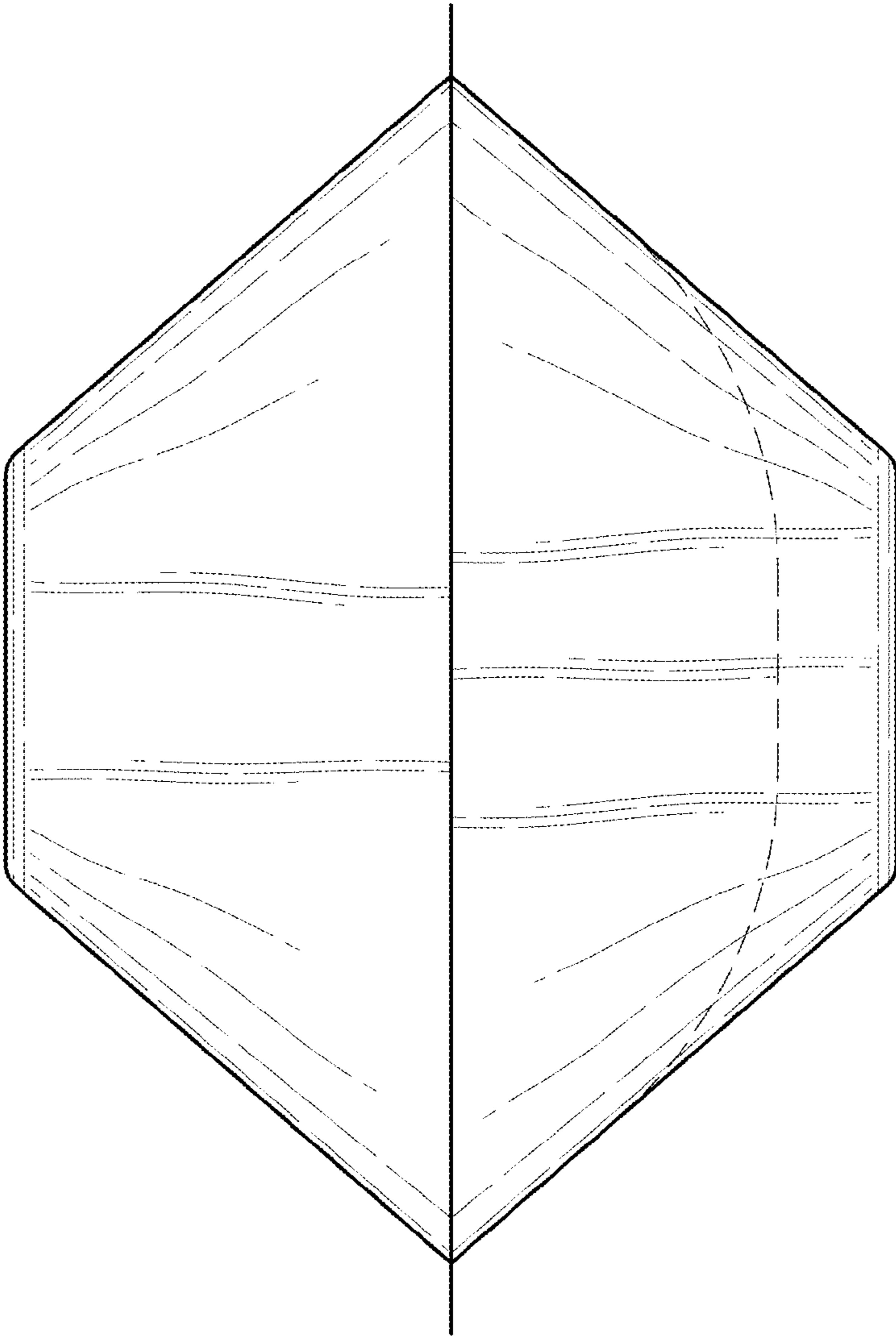

Fig. 20

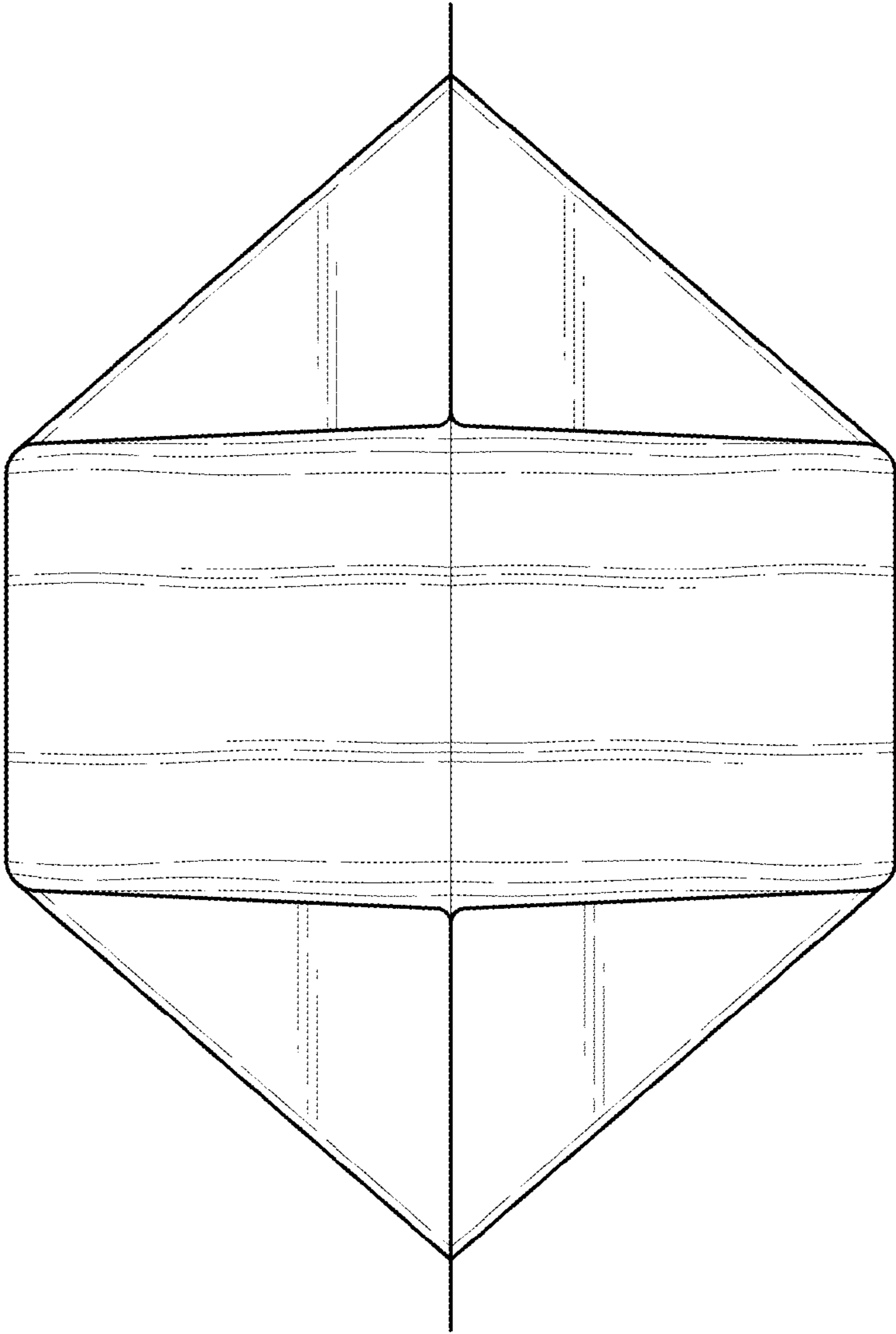

Fig. 21