



US00D742221S

(12) **United States Design Patent**  
**Casiddu**

(10) **Patent No.:** **US D742,221 S**  
(45) **Date of Patent:** **\*\* Nov. 3, 2015**

(54) **CAPSULE FOR MAKING BEVERAGES**

(71) Applicant: **CAFFITA SYSTEM S.p.A.**, Gaggio Montano (IT)

(72) Inventor: **Franco Casiddu**, Gaggio Montano (IT)

(73) Assignee: **Caffitaly System S.p.A.**, Gaggio Montano (Bologna) (IT)

(\*\*) Term: **14 Years**

(21) Appl. No.: **29/464,107**

(22) Filed: **Aug. 13, 2013**

(51) **LOC (10) Cl.** ..... **09-03**

(52) **U.S. Cl.**  
USPC ..... **D9/428**

(58) **Field of Classification Search**  
USPC ..... 220/564, 560.09, 568; D7/503, 513, D7/527, 541, 542, 545, 566, 586, 587, 601, D7/602, 612, 615, 619.1, 629, 630, 624.3, D7/373; 206/223, 541, 423, 501, 502, 503, 206/505, 508, 561, 564; 99/646 C, DIG. 15; D11/152, 153; D3/202, 203.3, 302, D3/304; D9/414, 416, 417, 418, 419, D9/420-438, 440, 447, 454, 499, 500, 502, D9/503, 904  
CPC ..... B65D 85/8043; B65D 85/8046; B65D 2565/385; B65D 2575/583; B65D 25/08; B65D 47/283; B65D 53/02; B65D 75/5883; B65D 81/18; B65D 81/3227; B65D 81/3277; B65D 85/70; B65D 2081/001; B65D 81/3238  
See application file for complete search history.

(56) **References Cited**

**U.S. PATENT DOCUMENTS**

D275,179 S \* 8/1984 Spencer et al. .... D9/520  
D539,643 S \* 4/2007 Abel ..... D9/424  
D645,340 S \* 9/2011 Menard et al. .... D9/428

D685,263 S \* 7/2013 Danenberg ..... D9/428  
D689,768 S \* 9/2013 Inderbitzin ..... D9/429  
D695,111 S \* 12/2013 Hansen et al. .... D9/429  
D697,797 S \* 1/2014 Hansen ..... D9/429  
D703,039 S \* 4/2014 Hansen ..... D9/429  
D715,649 S \* 10/2014 O'Brien ..... D9/500  
D716,648 S \* 11/2014 Tan ..... D9/416  
8,950,315 B2 \* 2/2015 Lai et al. .... 99/286  
2011/0005399 A1 \* 1/2011 Epars et al. .... 99/295  
2011/0111098 A1 \* 5/2011 Ricotti ..... 426/89  
2011/0142996 A1 \* 6/2011 Kruger ..... 426/80  
2012/0171332 A1 \* 7/2012 Lai et al. .... 426/78  
2014/0010926 A1 \* 1/2014 Digioni ..... 426/112  
2014/0037803 A1 \* 2/2014 Hansen ..... 426/115  
2014/0087028 A1 \* 3/2014 Orsi ..... 426/77  
2014/0220190 A1 \* 8/2014 Giovanni ..... 426/115

**FOREIGN PATENT DOCUMENTS**

EP 1944248 A1 \* 7/2008  
EP 2394932 A1 \* 12/2011

\* cited by examiner

*Primary Examiner* — Philip S Hyder

*Assistant Examiner* — Keith Frank

(74) *Attorney, Agent, or Firm* — Maginot, Moore & Beck, LLP

(57) **CLAIM**

The ornamental design for a capsule for making beverages, as shown and described.

**DESCRIPTION**

FIG. 1 is a front perspective view of a capsule for making beverages;

FIG. 2 is a side elevational view, with the view being the same 360° around the capsule thereof;

FIG. 3 is a top elevational view thereof; and,

FIG. 4 is a bottom elevational view thereof.

**1 Claim, 4 Drawing Sheets**

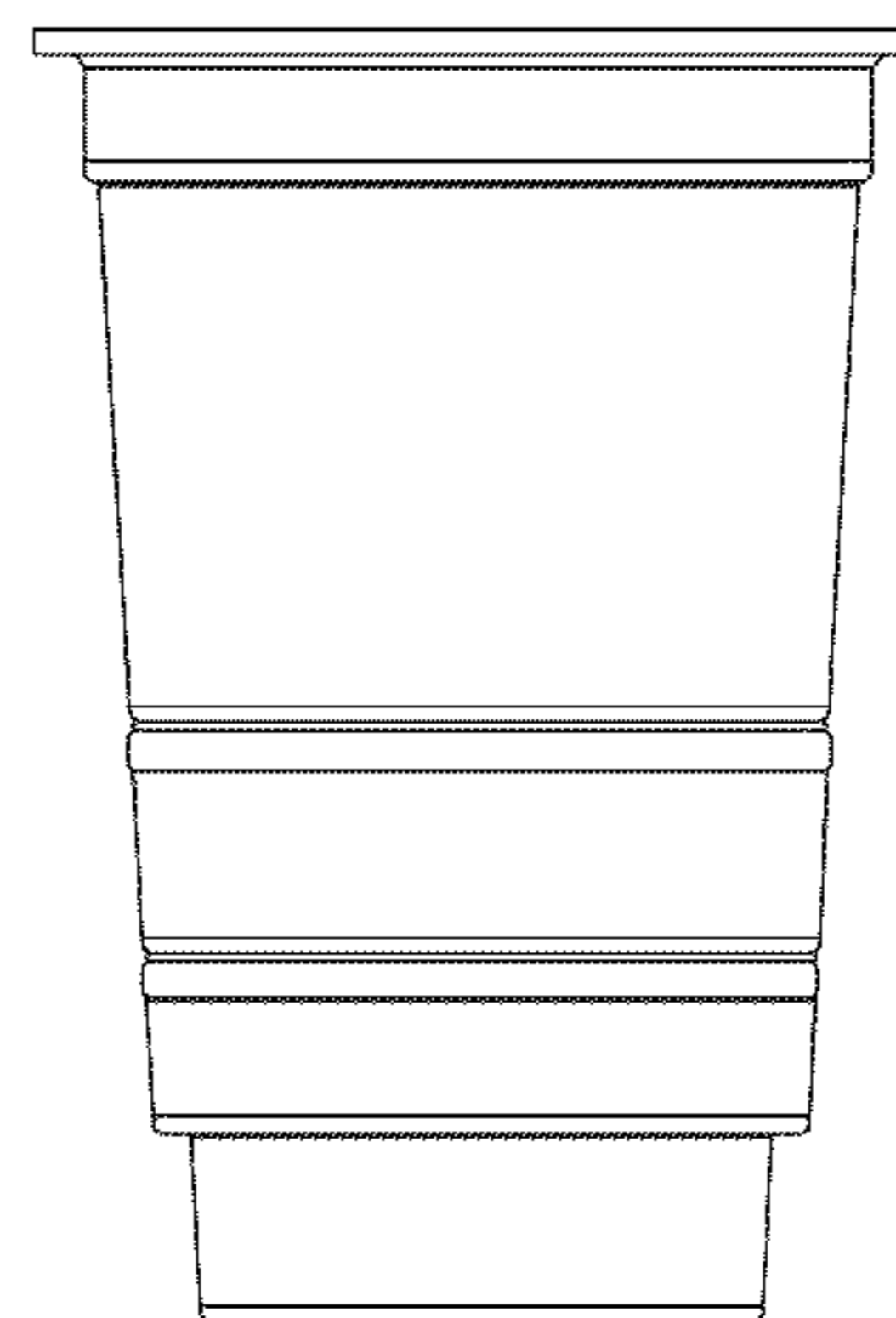
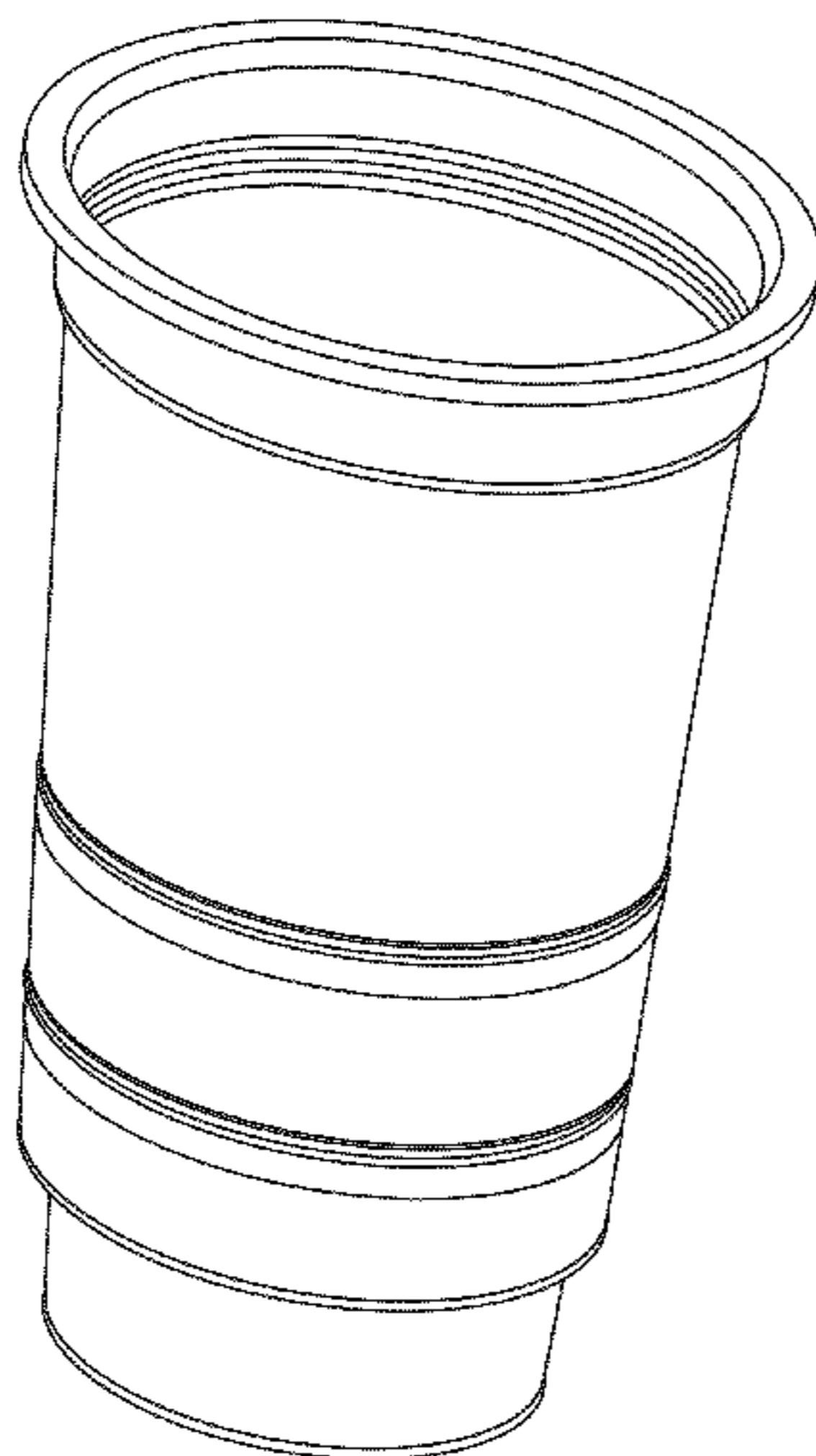

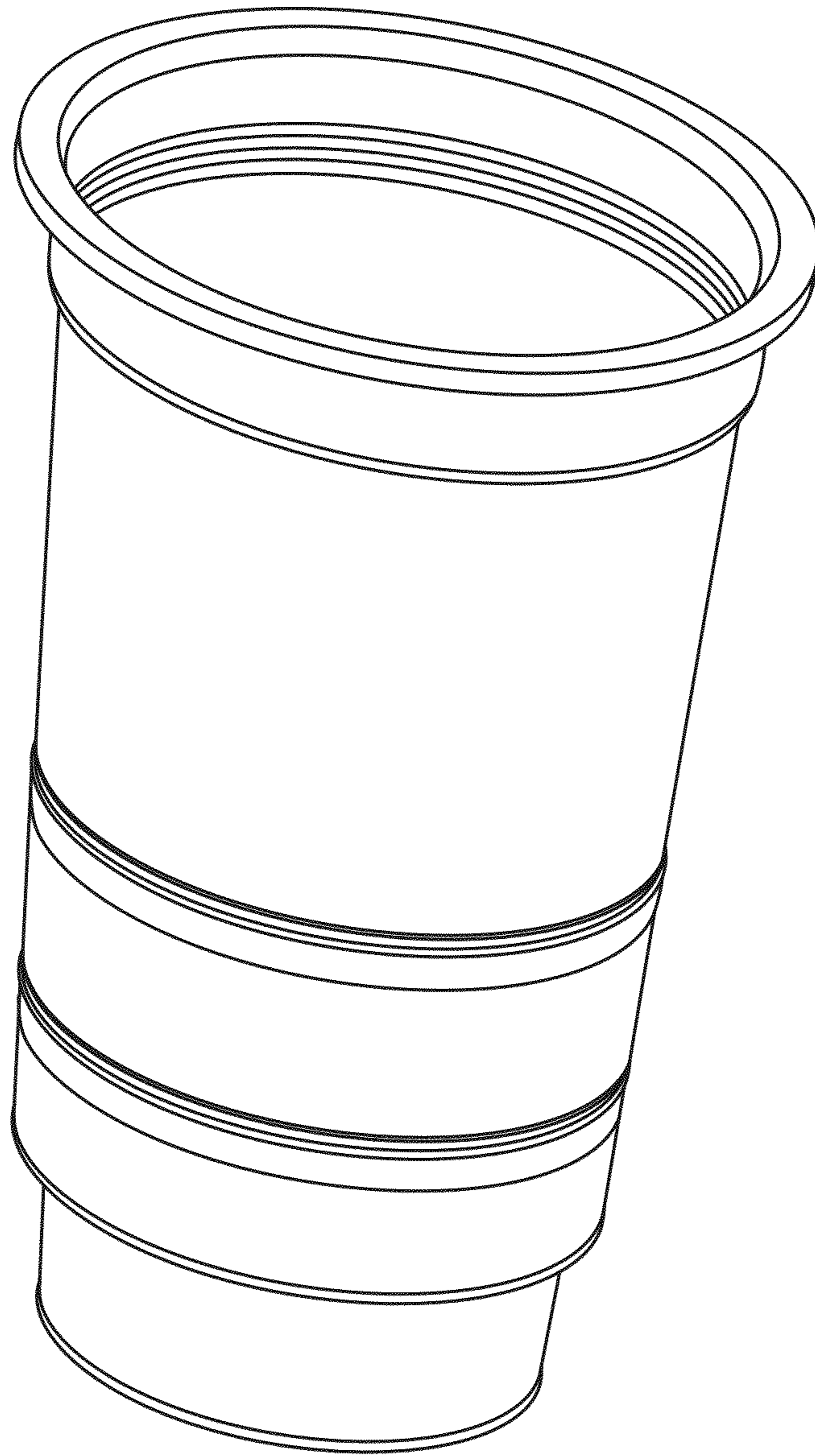

FIG. 1

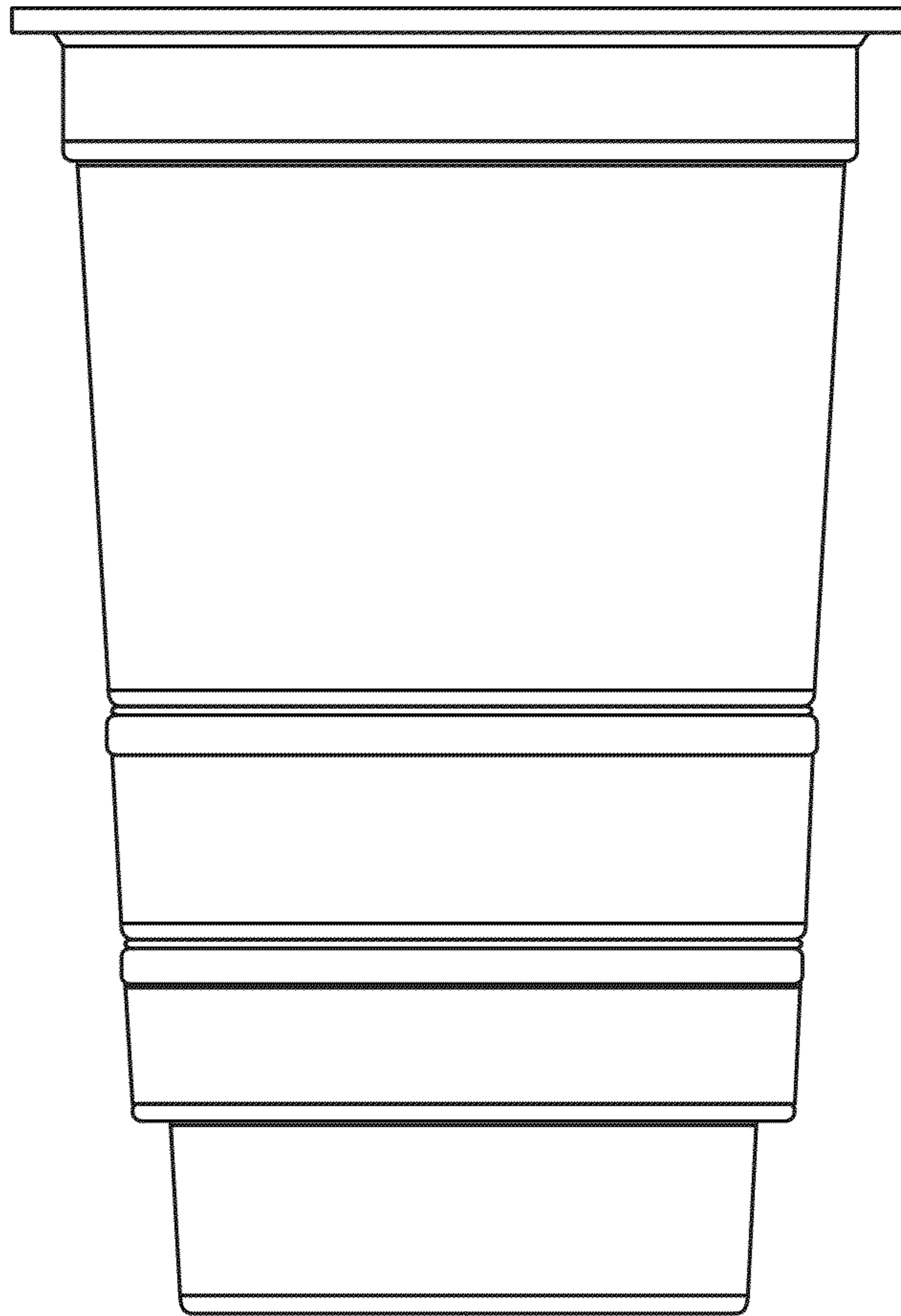

FIG. 2

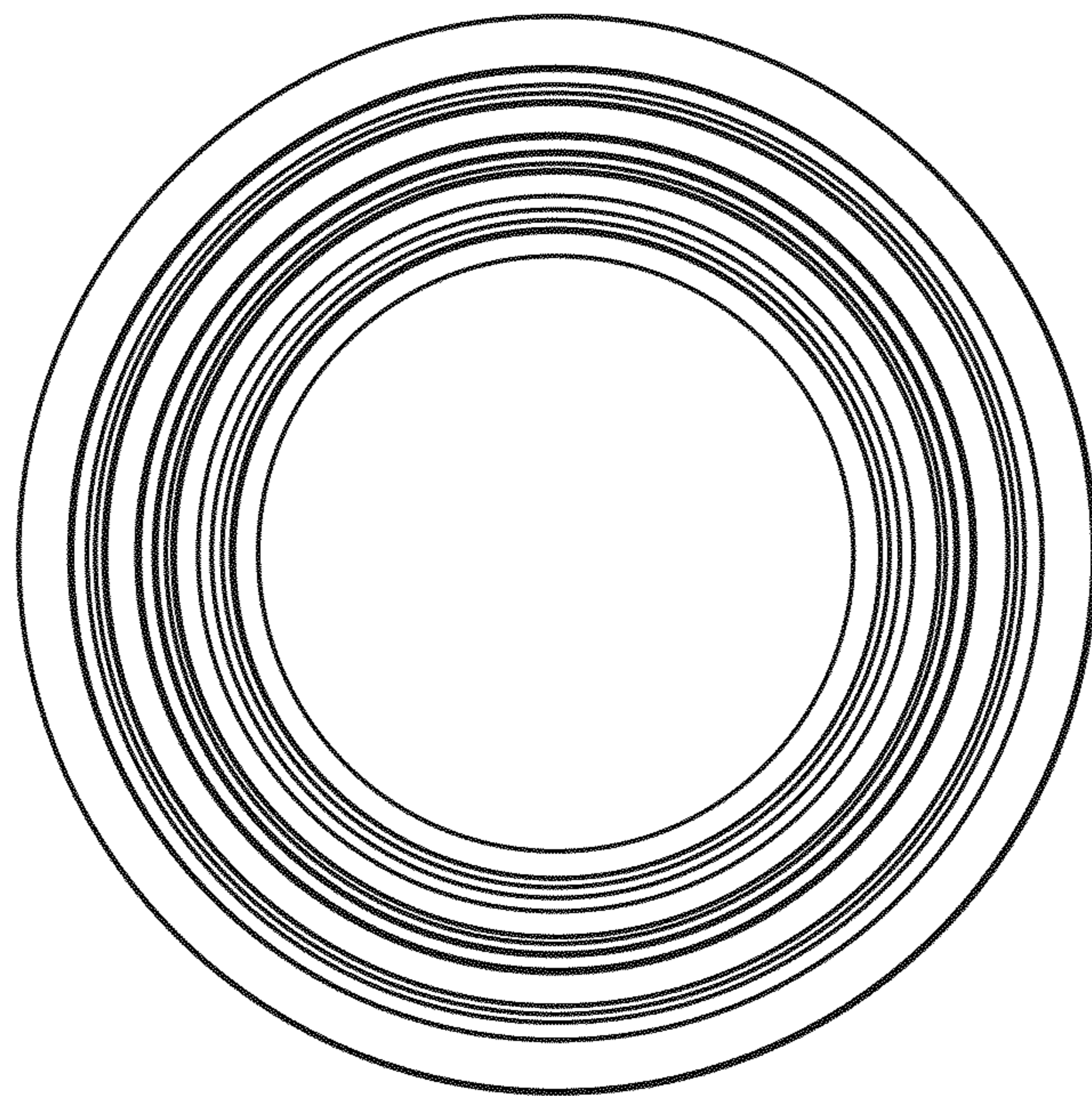

FIG. 3



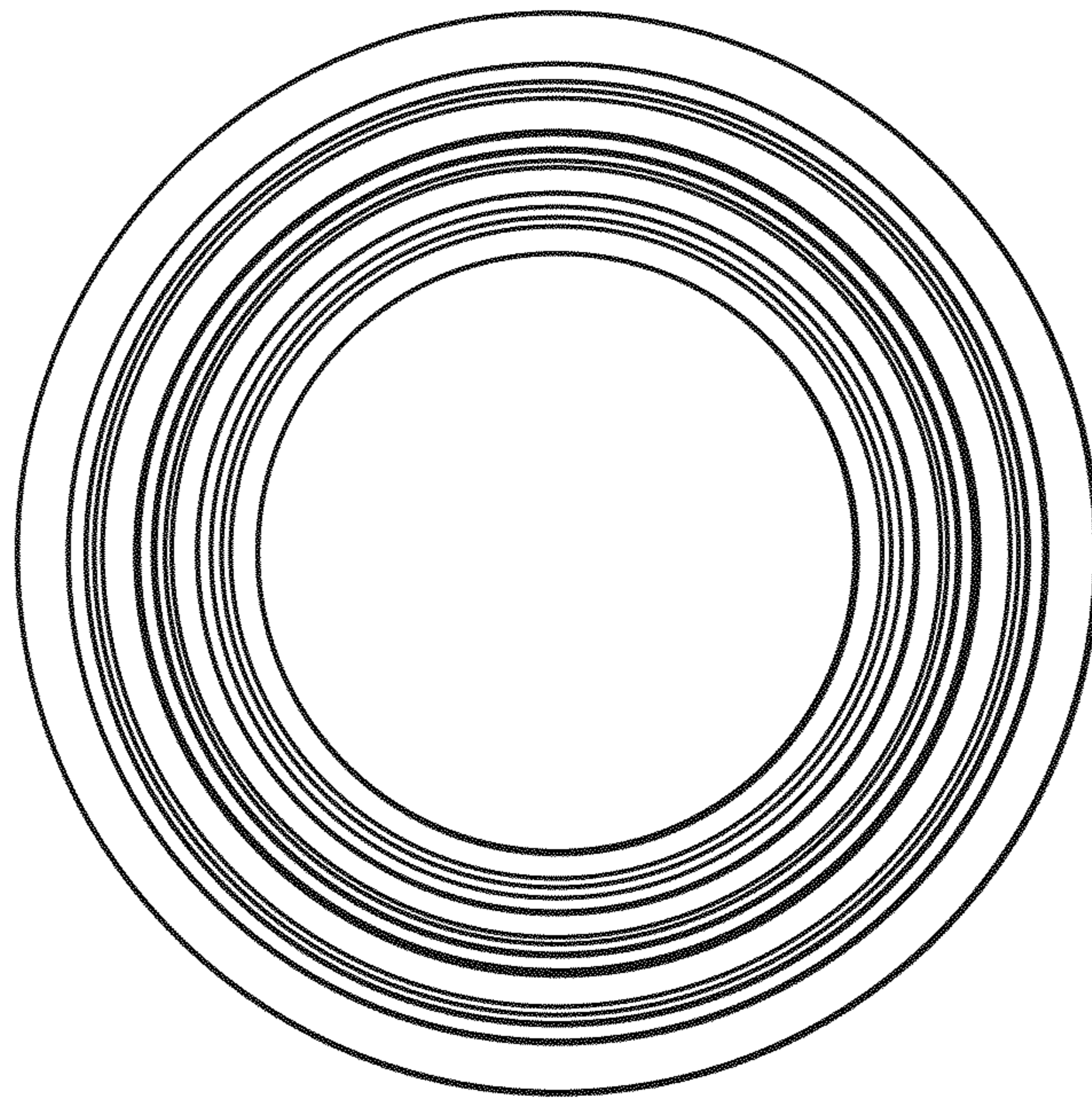

FIG. 4

UNITED STATES PATENT AND TRADEMARK OFFICE  
**CERTIFICATE OF CORRECTION**

PATENT NO. : D742,221 S  
APPLICATION NO. : 29/464107  
DATED : November 3, 2015  
INVENTOR(S) : Franco Casiddu

Page 1 of 6

It is certified that error appears in the above-identified patent and that said Letters Patent is hereby corrected as shown below:

Delete title page and substitute therefore with the attached title page consisting of the corrected illustrative figures.

Delete Drawing Sheets 1-4 and substitute therefore the attached Drawing Sheets 1-4. FIGS. 1-4 have been corrected.

Signed and Sealed this  
Twenty-third Day of February, 2016



Michelle K. Lee  
*Director of the United States Patent and Trademark Office*

(12) **United States Design Patent**  
**Casiddu**

(10) **Patent No.:** **US D742,221 S**  
(45) **Date of Patent:** **\*\* Nov. 3, 2015**

(54) **CAPSULE FOR MAKING BEVERAGES**  
(71) **Applicant:** **CAFFITA SYSTEM S.p.A.**, Gaggio Montano (IT)  
(72) **Inventor:** **Franco Casiddu**, Gaggio Montano (IT)  
(73) **Assignee:** **Caffitaly System S.p.A.**, Gaggio Montano (Bologna) (IT)  
(\*\*) **Term:** **14 Years**  
(21) **Appl. No.:** **29/464,107**

(22) **Filed:** **Aug. 13, 2013**  
(51) **LOC (10) Cl.** ..... **09-03**  
(52) **U.S. Cl.**  
USPC ..... **D9/428**  
(58) **Field of Classification Search**  
USPC ..... 220/564, 560.09, 568; D7/503, 513, D7/527, 541, 542, 545, 566, 586, 587, 601, 107/602, 612, 615, 619.1, 629, 630, 624.3, D7/373; 206/223, 541, 423, 501, 502, 503, 206/505, 508, 561, 564; 99/646 C, DIG. 15; D11/152, 153; D3/202, 203.3, 302, D3/304; D9/414, 416, 417, 418, 419, D9/420-438, 440, 447, 454, 499, 500, 502, D9/503, 904  
CPC ..... B65D 85/8043; B65D 85/8046; B65D 2565/385; B65D 2575/583; B65D 25/08; B65D 47/283; B65D 53/02; B65D 75/5883; B65D 81/18; B65D 81/3227; B65D 81/3277; B65D 85/70; B65D 2081/001; B65D 81/3238  
See application file for complete search history.

(56) **References Cited**  
**U.S. PATENT DOCUMENTS**

D275,179 S \* 8/1984 Spencer et al. .... D9/520  
D539,643 S \* 4/2007 Abel ..... D9/424  
D645,340 S \* 9/2011 Menard et al. .... D9/428

D685,263 S \* 7/2013 Danenberg ..... D9/428  
D689,768 S \* 9/2013 Inderbitzin ..... D9/429  
D695,111 S \* 12/2013 Hansen et al. .... D9/429  
D697,797 S \* 1/2014 Hansen ..... D9/429  
D703,039 S \* 4/2014 Hansen ..... D9/429  
D715,649 S \* 10/2014 O'Brien ..... D9/500  
D716,648 S \* 11/2014 Tan ..... D9/416  
8,950,315 B2 \* 2/2015 Lai et al. .... 99/286  
2011/0005399 A1 \* 1/2011 Fpars et al. .... 99/295  
2011/0111098 A1 \* 5/2011 Ricotti ..... 426/89  
2011/0142996 A1 \* 6/2011 Kruger ..... 426/80  
2012/0171332 A1 \* 7/2012 Lai et al. .... 426/78  
2014/0010926 A1 \* 1/2014 Digiumi ..... 426/112  
2014/0037803 A1 \* 2/2014 Hansen ..... 426/115  
2014/0087028 A1 \* 3/2014 Orsi ..... 426/77  
2014/0220190 A1 \* 8/2014 Giovanni ..... 426/115

**FOREIGN PATENT DOCUMENTS**

EP 1944248 A1 \* 7/2008  
EP 2394932 A1 \* 12/2011

\* cited by examiner

*Primary Examiner* — Philip S Hyder  
*Assistant Examiner* — Keith Frank  
(74) *Attorney, Agent, or Firm* — Maginot, Moore & Beck, LLP

(57) **CLAIM**  
The ornamental design for a capsule for making beverages, as shown and described.

**DESCRIPTION**

FIG. 1 is a front perspective view of a capsule for making beverages;  
FIG. 2 is a side elevational view, with the view being the same 360° around the capsule thereof;  
FIG. 3 is a top elevational view thereof; and,  
FIG. 4 is a bottom elevational view thereof.

**1 Claim, 4 Drawing Sheets**

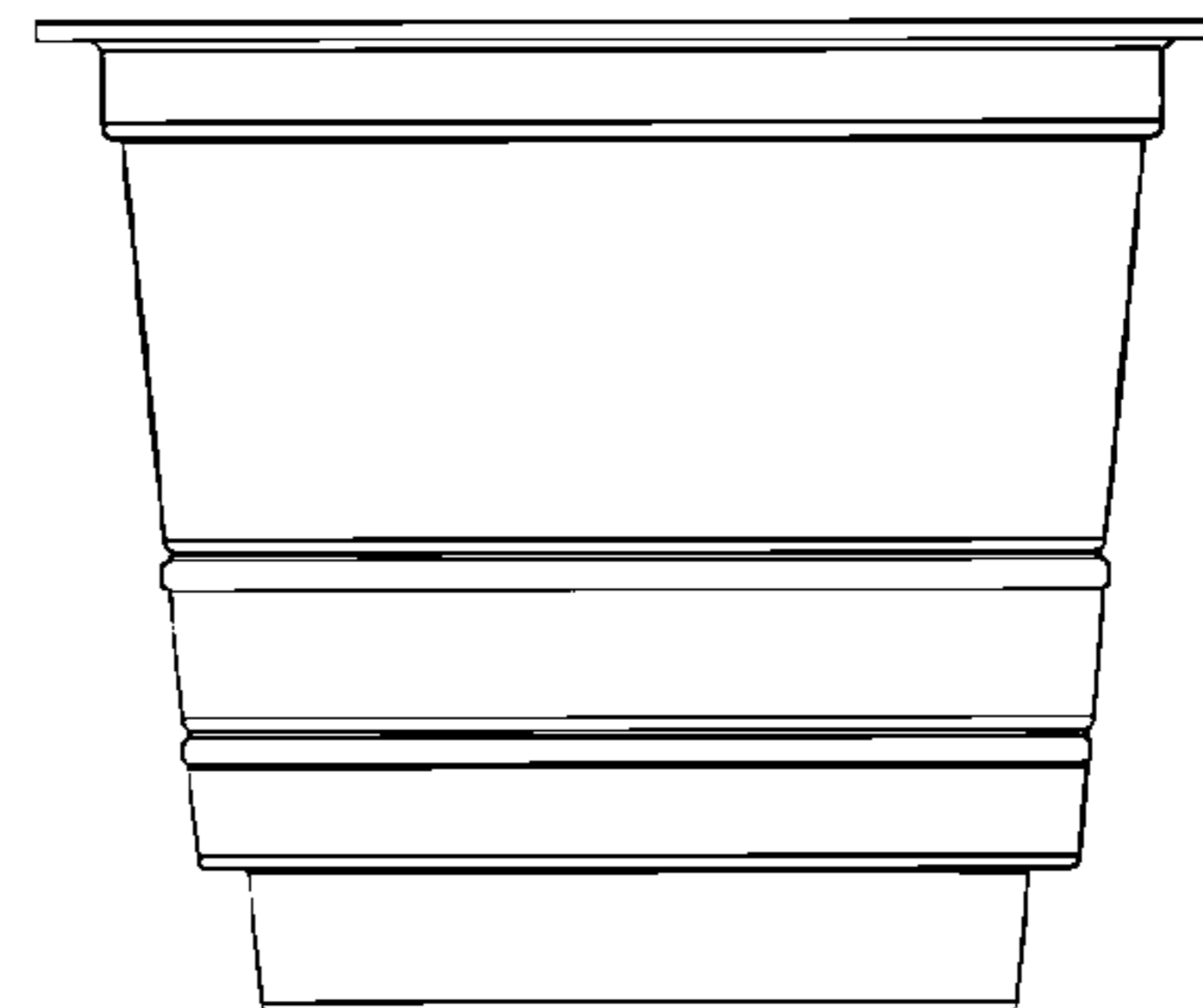
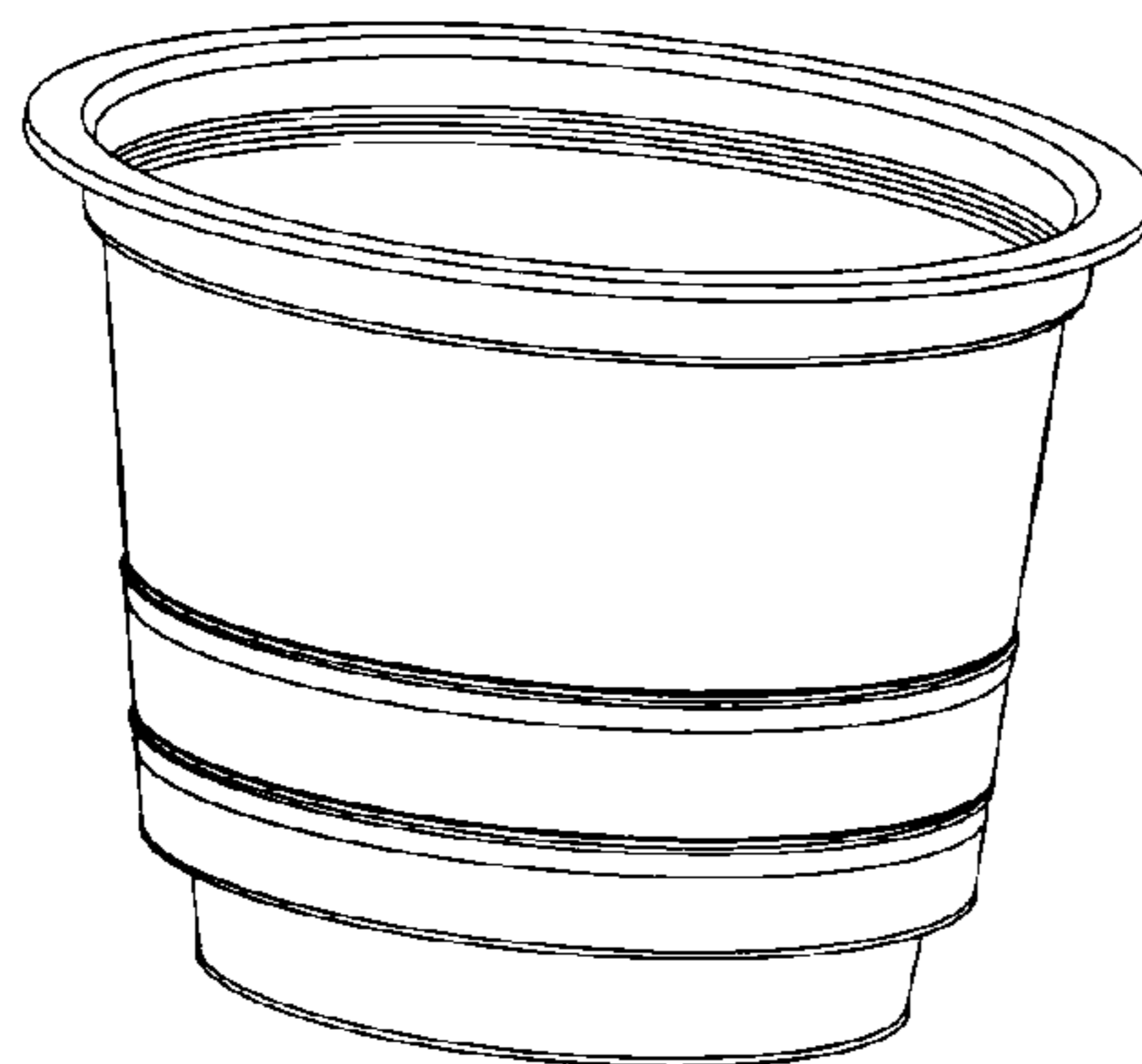



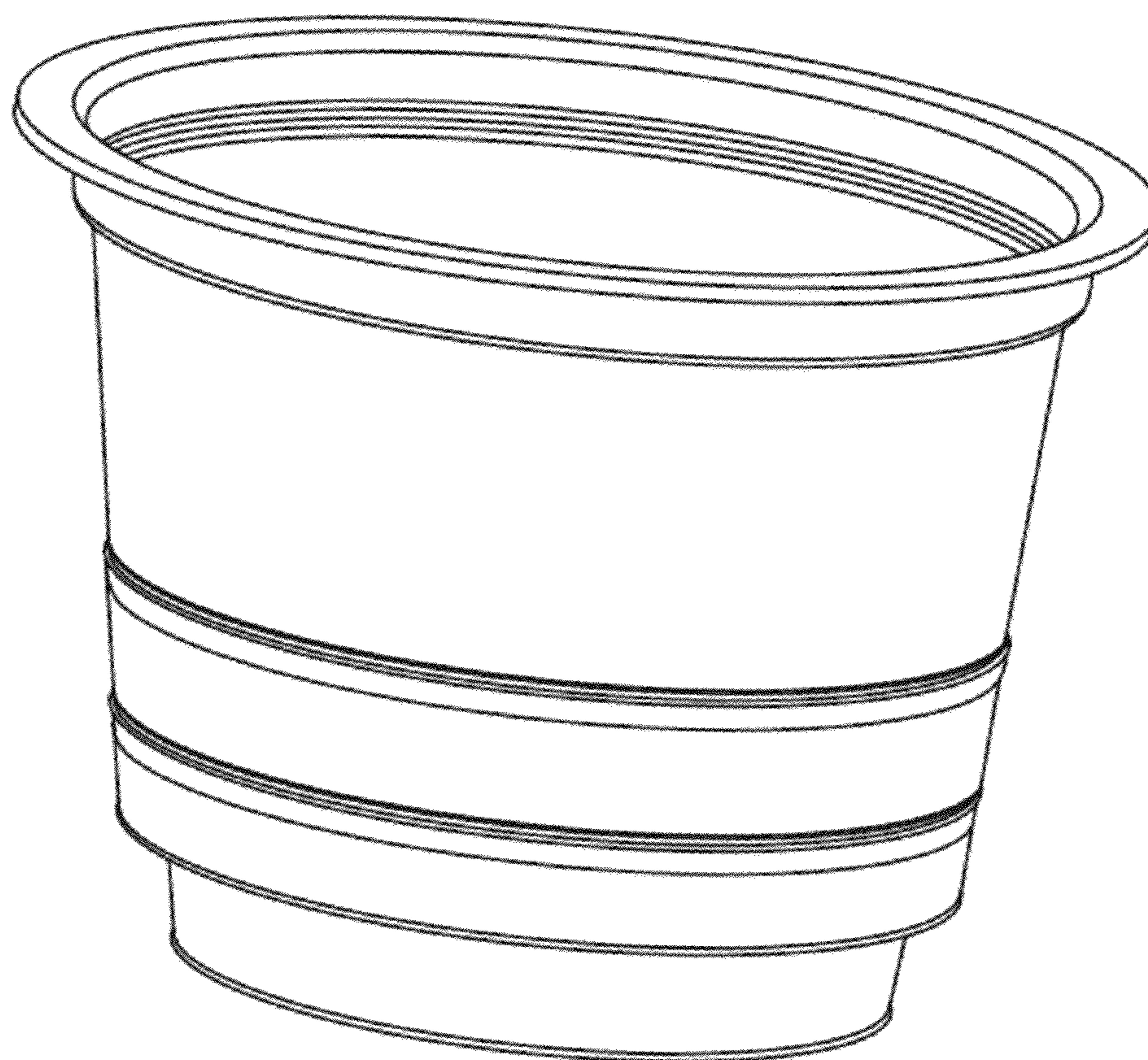

FIG. 1



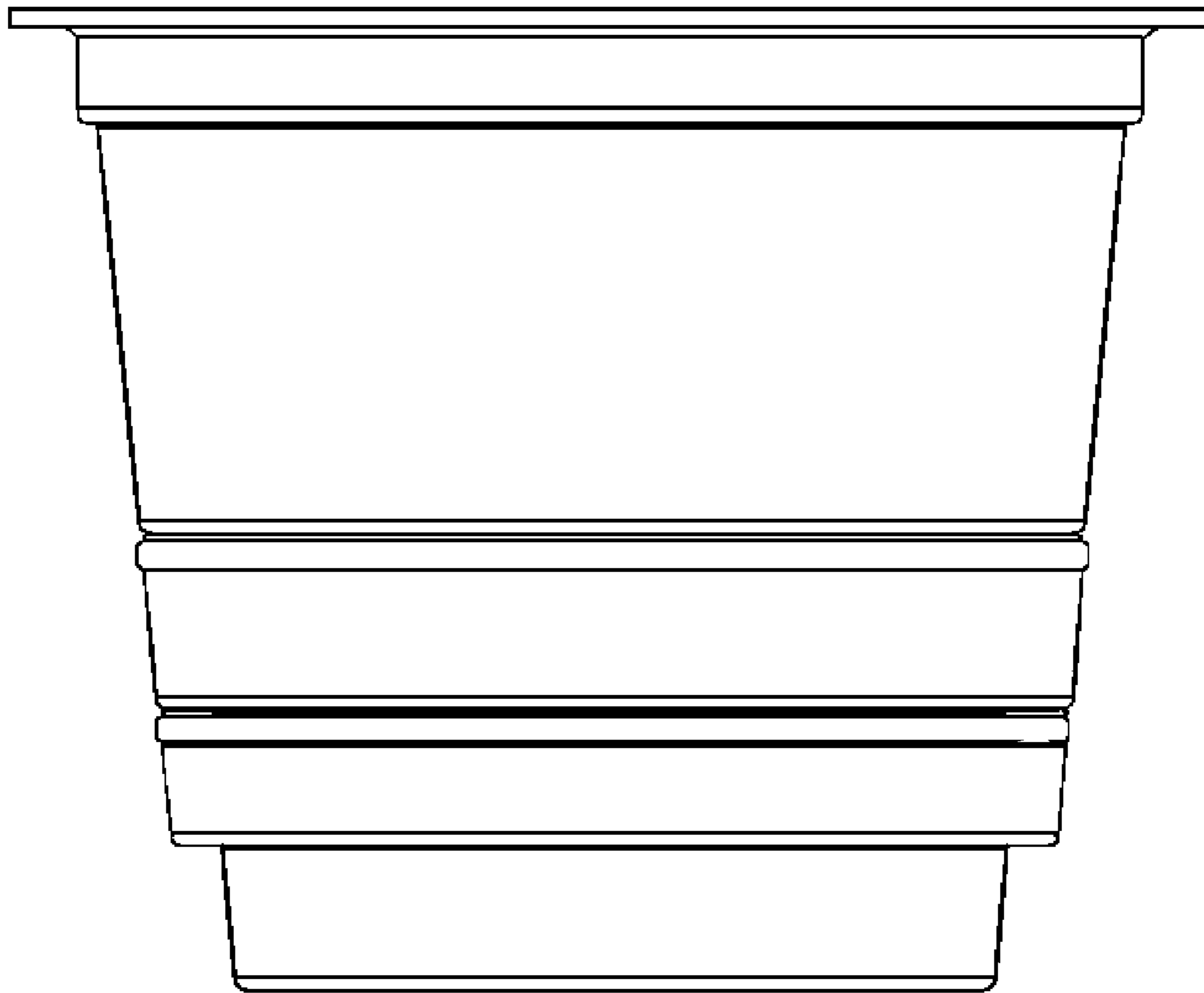

FIG. 2

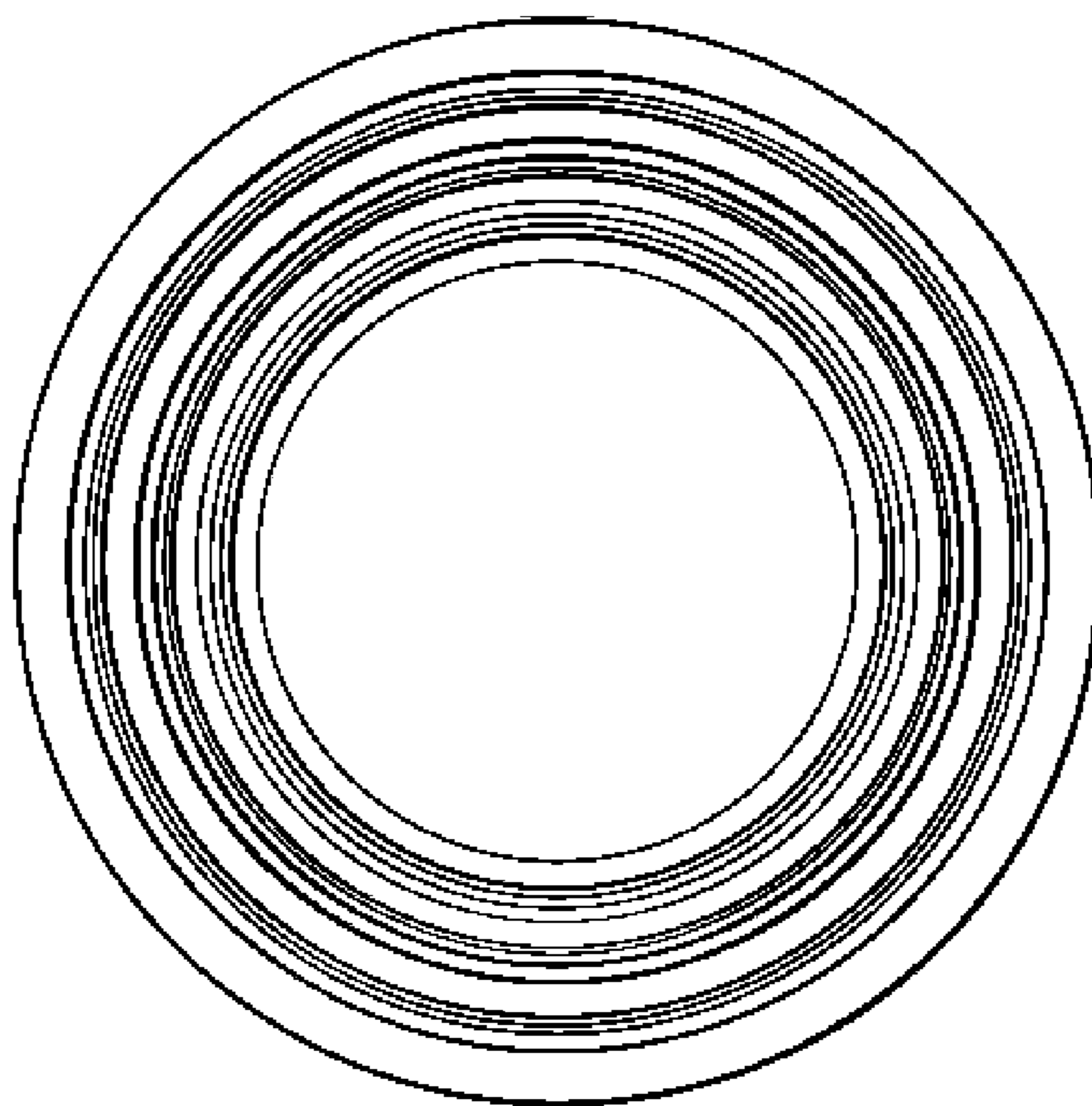

FIG. 3

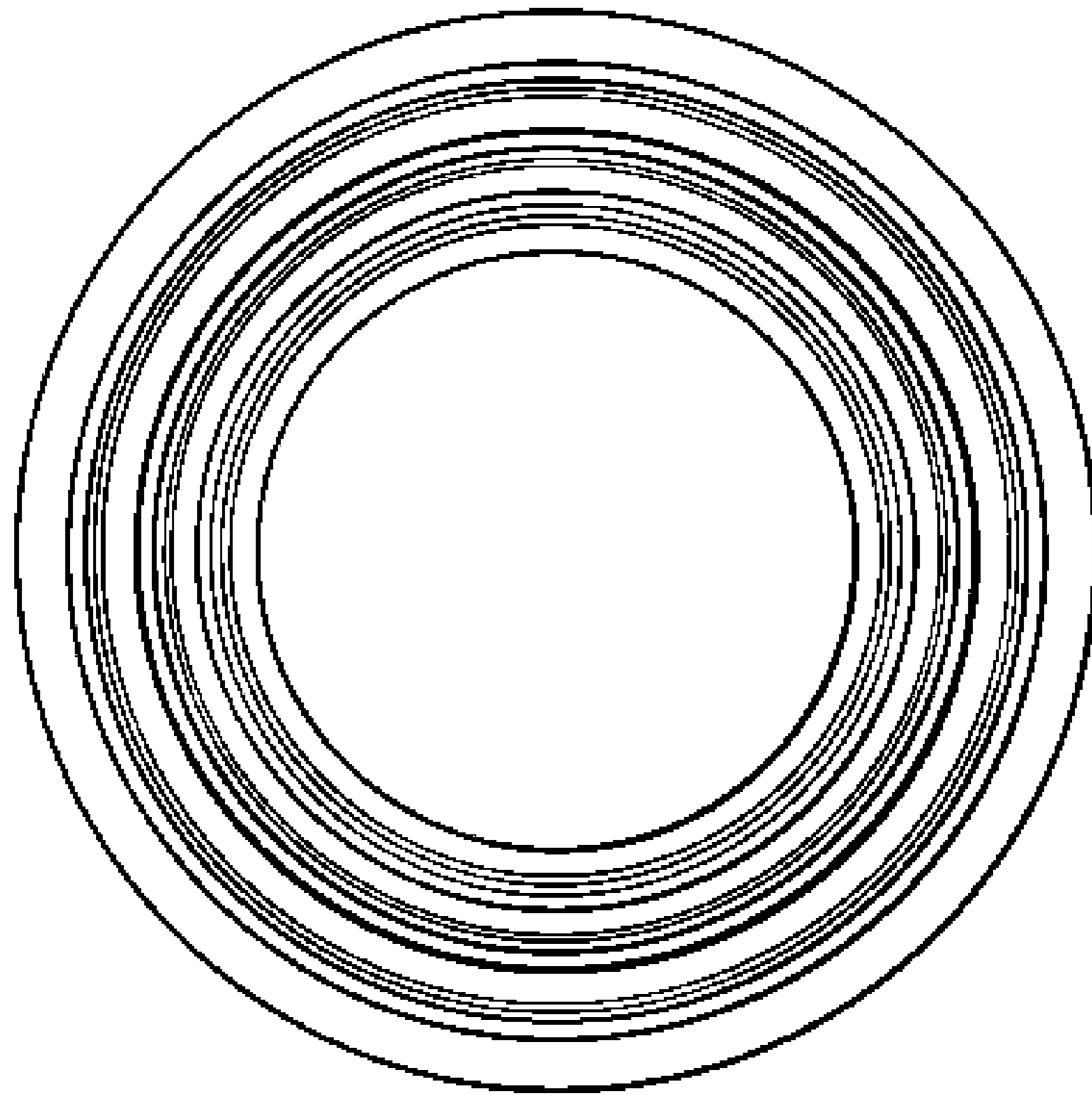

FIG. 4