



US00D742135S

(12) **United States Design Patent**
Dix

(10) **Patent No.:** **US D742,135 S**

(45) **Date of Patent:** **** Nov. 3, 2015**

(54) **SEAT**

(71) Applicant: **SOUTHERN MOTION, INC.**,
Pontotoc, MS (US)

(72) Inventor: **George K Dix**, Pontotoc, MS (US)

(73) Assignee: **Southern Motion, Inc.**, Pontotoc, MS
(US)

(**) Term: **14 Years**

(21) Appl. No.: **29/517,932**

(22) Filed: **Feb. 18, 2015**

(51) **LOC (10) Cl.** **06-01**

(52) **U.S. Cl.**
USPC **D6/381**

(58) **Field of Classification Search**
USPC 22/334–338, 349, 355, 361, 368–370,
22/376, 379–381, 716, 716.1, 716.2, 340,
22/354, 377, 709, 710, 716.4, 367;
297/16.1, 42, 94, 135, 175, 232, 233,
297/350, 351, 445.1, 448.1, 448.2, 451.9,
297/452.1, DIG. 7; 5/12.1, 12.2
CPC A47C 1/02; A47C 1/024; A47C 7/18;
A47C 7/24; A47C 17/00; A47C 17/02;
A47C 17/175

See application file for complete search history.

(56) **References Cited**

U.S. PATENT DOCUMENTS

D390,372 S *	2/1998	Lewis et al.	D6/381
D469,973 S *	2/2003	Ricci	D6/381
D470,325 S *	2/2003	Ricci	D6/381
D493,298 S *	7/2004	Ricci	D6/381
D495,517 S *	9/2004	Ricci	D6/381

D504,029 S *	4/2005	Ricci	D6/381
D504,030 S *	4/2005	Ricci	D6/381
D512,241 S *	12/2005	Ricci	D6/381

(Continued)

OTHER PUBLICATIONS

U.S. co-pending design U.S. Appl. No. 29/517,934, filed Feb. 18, 2015 “SEAT” pp. 1-19.

Primary Examiner — Sandra Snapp

(74) *Attorney, Agent, or Firm* — Thomas G. Peterson;
Bradley Arant Boult Cummings LLP

(57) **CLAIM**

The ornamental design for a seat, as shown and described.

DESCRIPTION

FIG. 1 shows a perspective view of a first embodiment of the seat in accordance with the new design.

FIG. 2 shows a front elevation view of the embodiment of FIG. 1.

FIG. 3 shows a rear view of the embodiment of FIG. 1.

FIG. 4 shows a top view of the embodiment of FIG. 1.

FIG. 5 shows a side view of the embodiment of FIG. 1.

FIG. 6 shows a perspective view of a second embodiment of the seat in accordance with the new design.

FIG. 7 shows a front elevation view of the embodiment of FIG. 6.

FIG. 8 shows a rear view of the embodiment of FIG. 6.

FIG. 9 shows a top view of the embodiment of FIG. 6.

FIG. 10 shows a perspective view of a third embodiment of the seat in accordance with the new design.

FIG. 11 shows a front elevation view of the embodiment of FIG. 10.

FIG. 12 shows a rear view of the embodiment of FIG. 10; and, FIG. 13 shows a top view of the embodiment of FIG. 10.

The dashed lines shown in the drawings illustrate environmental structure and form no part of the claimed design.

1 Claim, 13 Drawing Sheets

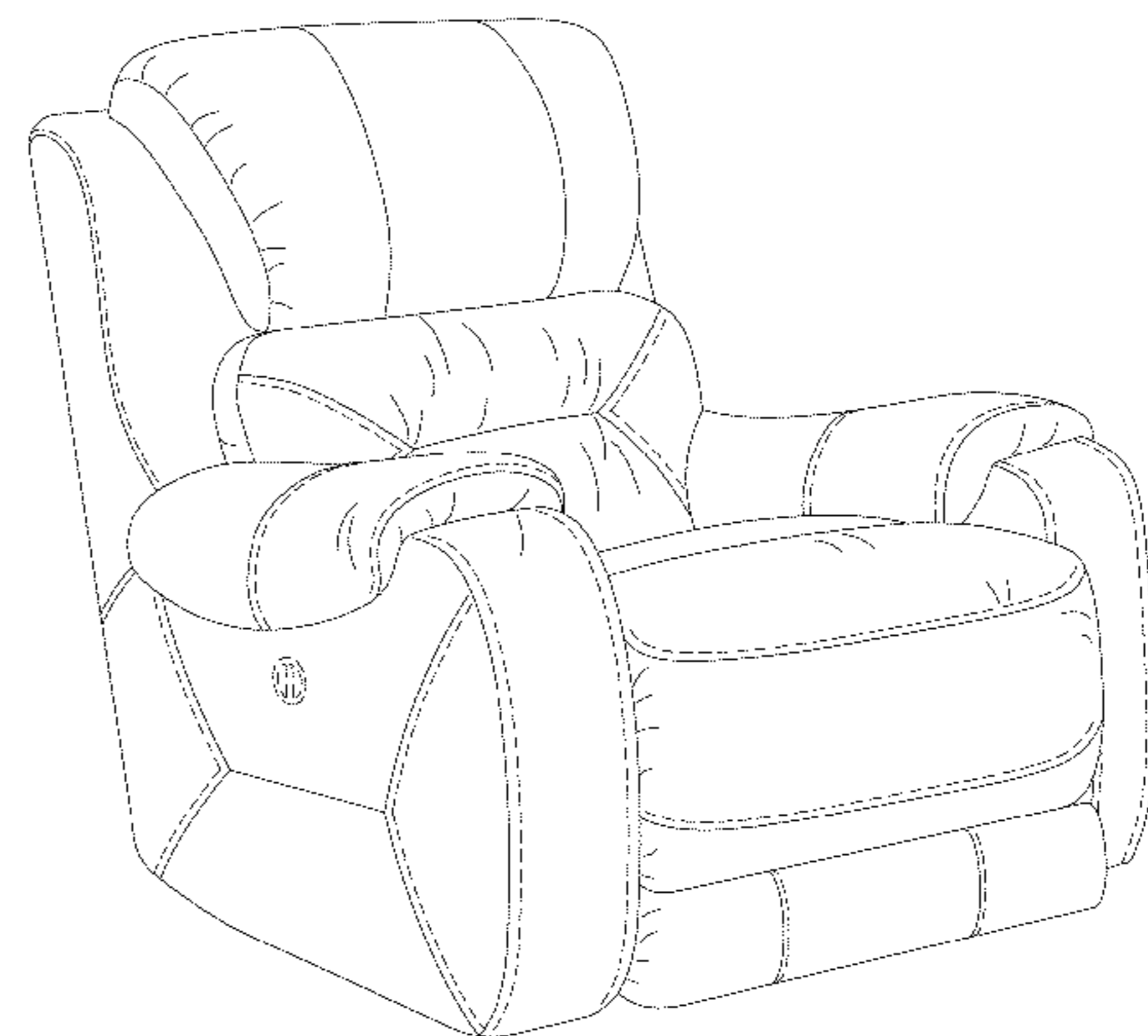
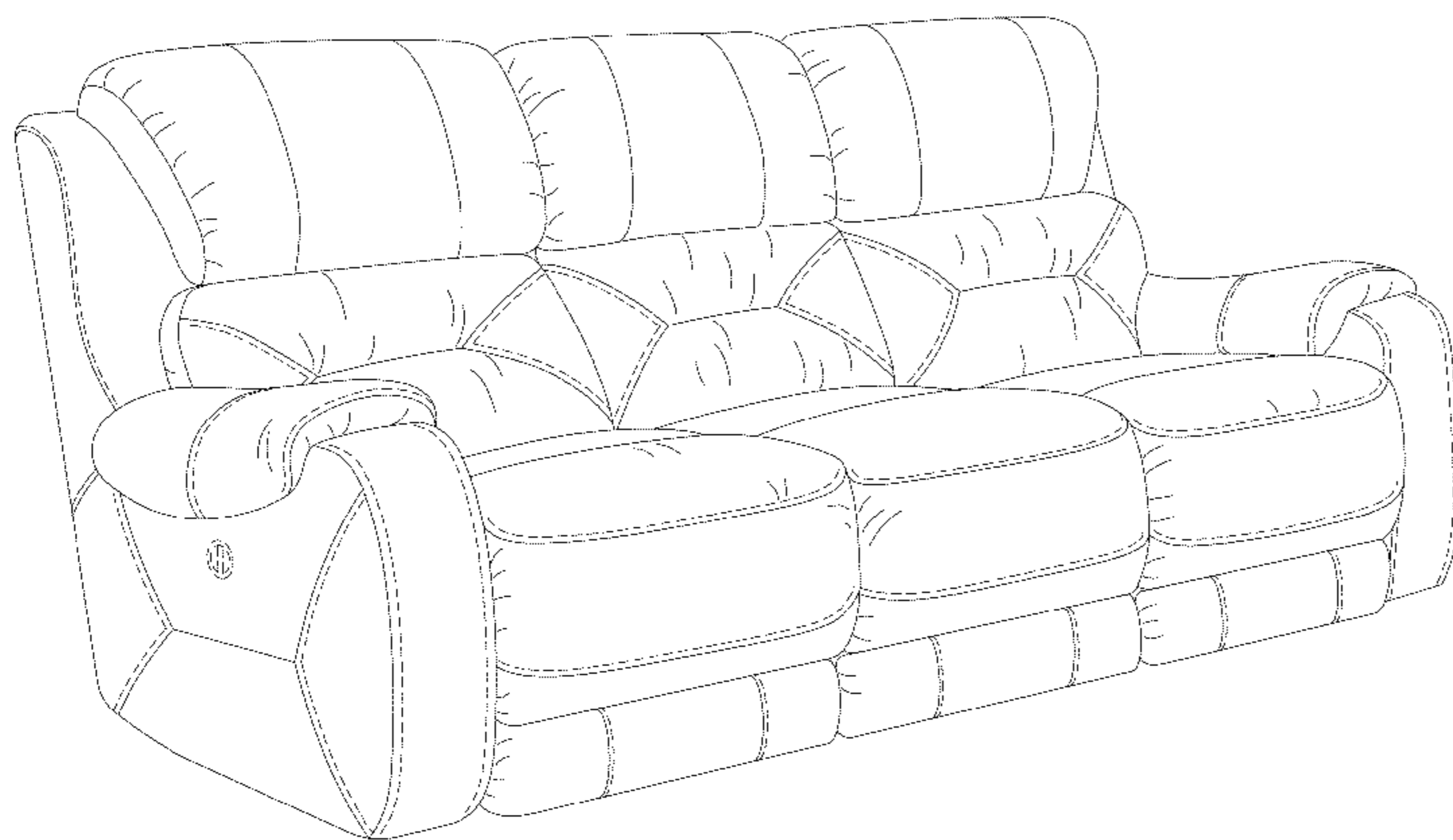

(56)

References Cited

U.S. PATENT DOCUMENTS

D512,847 S * 12/2005 Ricci D6/381
D522,868 S * 6/2006 Bowen et al. D9/528
D544,242 S * 6/2007 Ricci D6/381

D547,090 S * 7/2007 Natuzzi D6/381
D634,940 S * 3/2011 Crockett D6/381
D634,941 S * 3/2011 Crockett D6/381
D721,516 S * 1/2015 Adair et al. D6/381
D721,899 S * 2/2015 Adair et al. D6/381

* cited by examiner

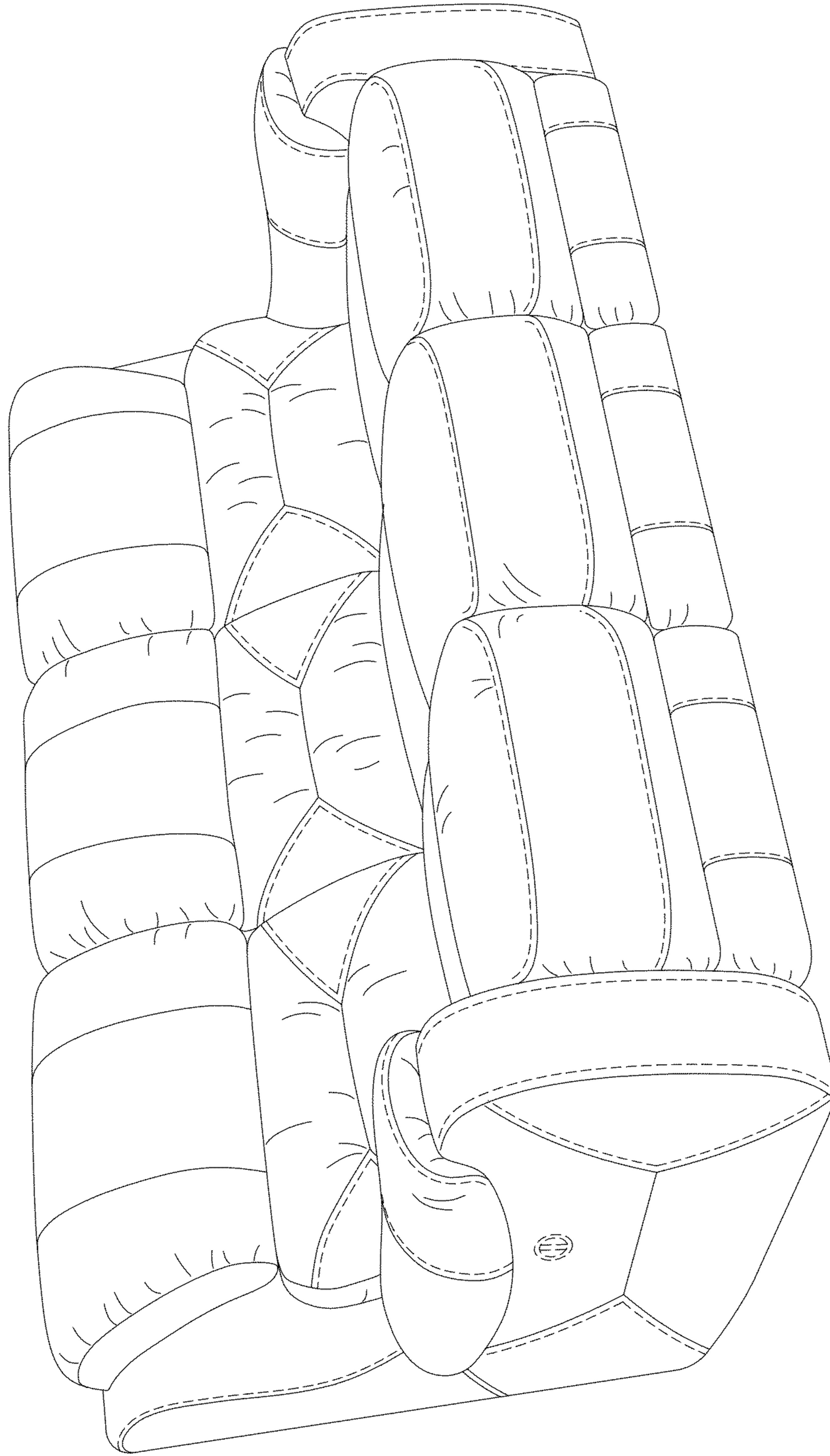

FIG. 1

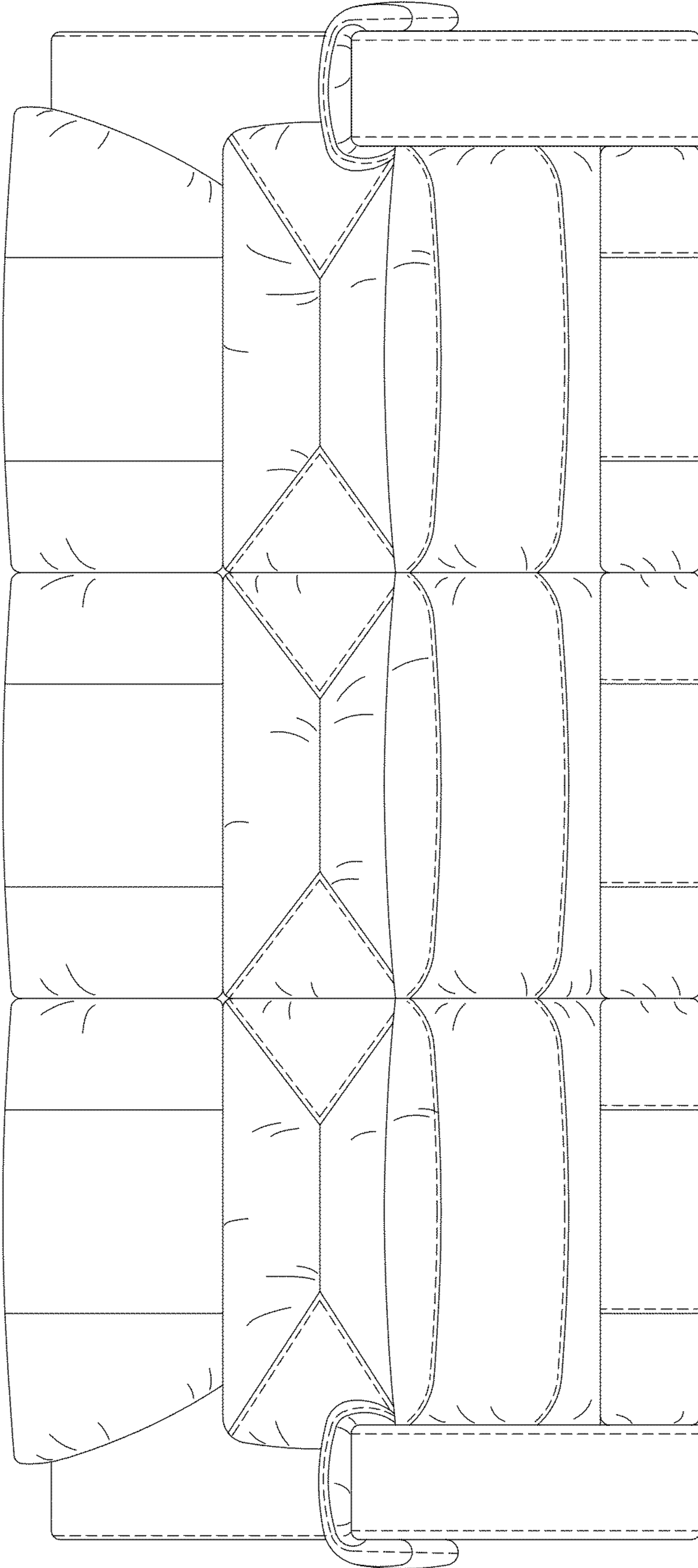

FIG. 2

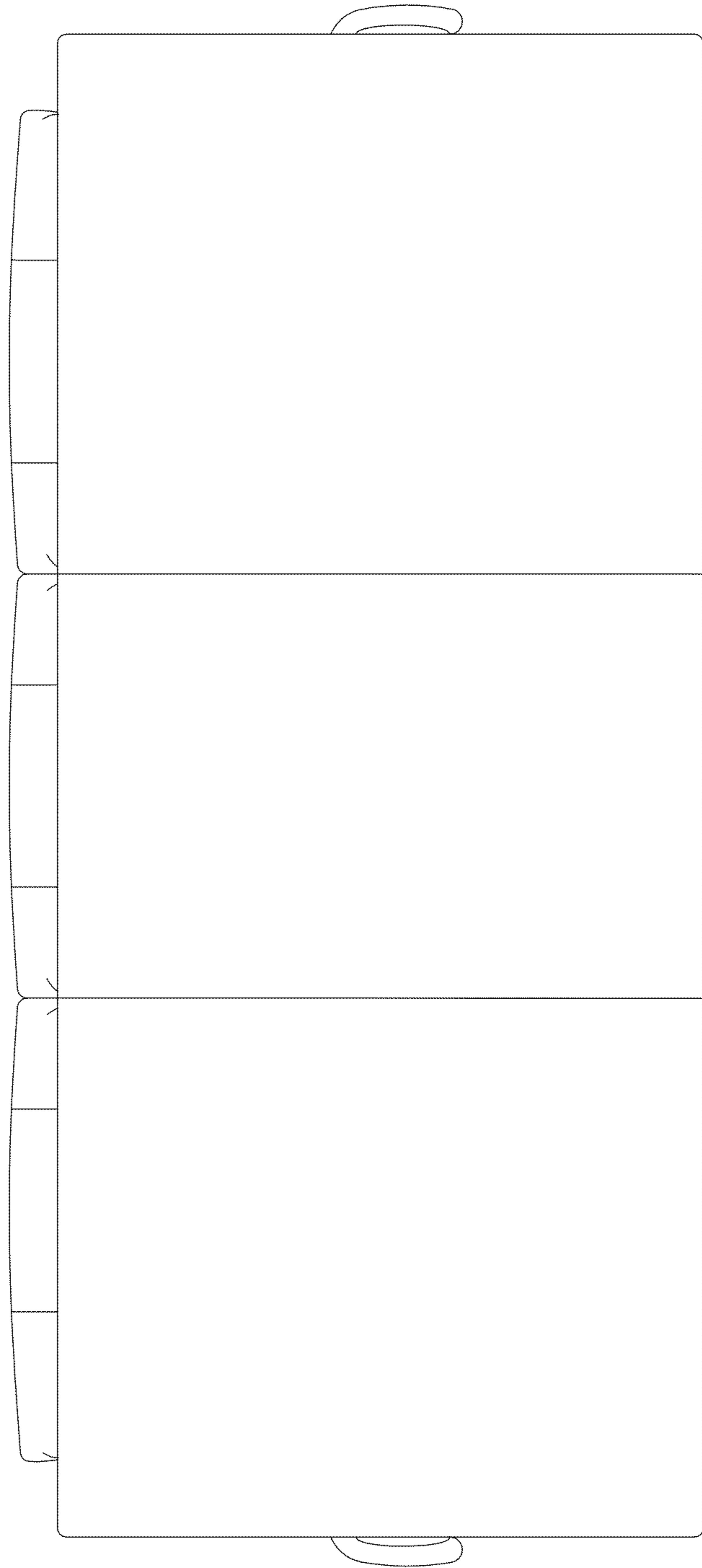

FIG. 3

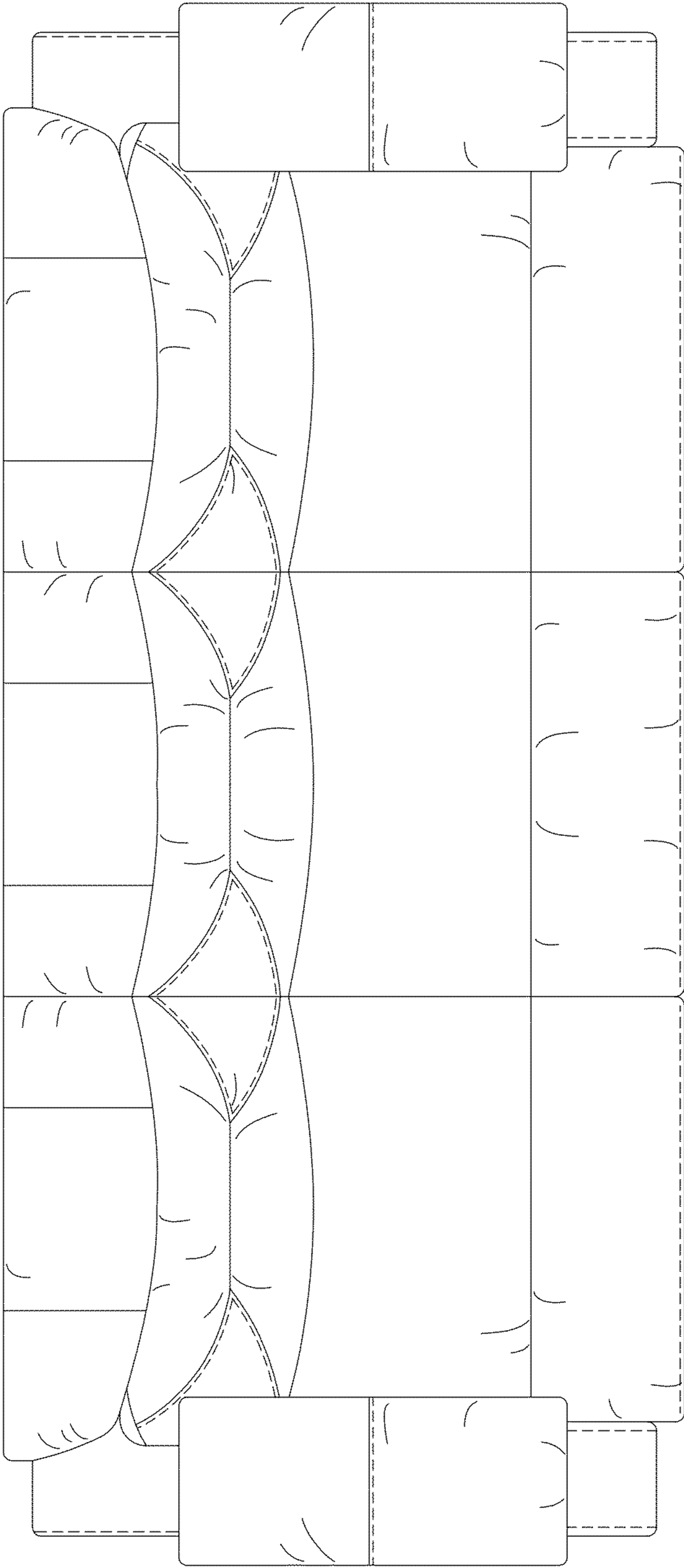

FIG. 4

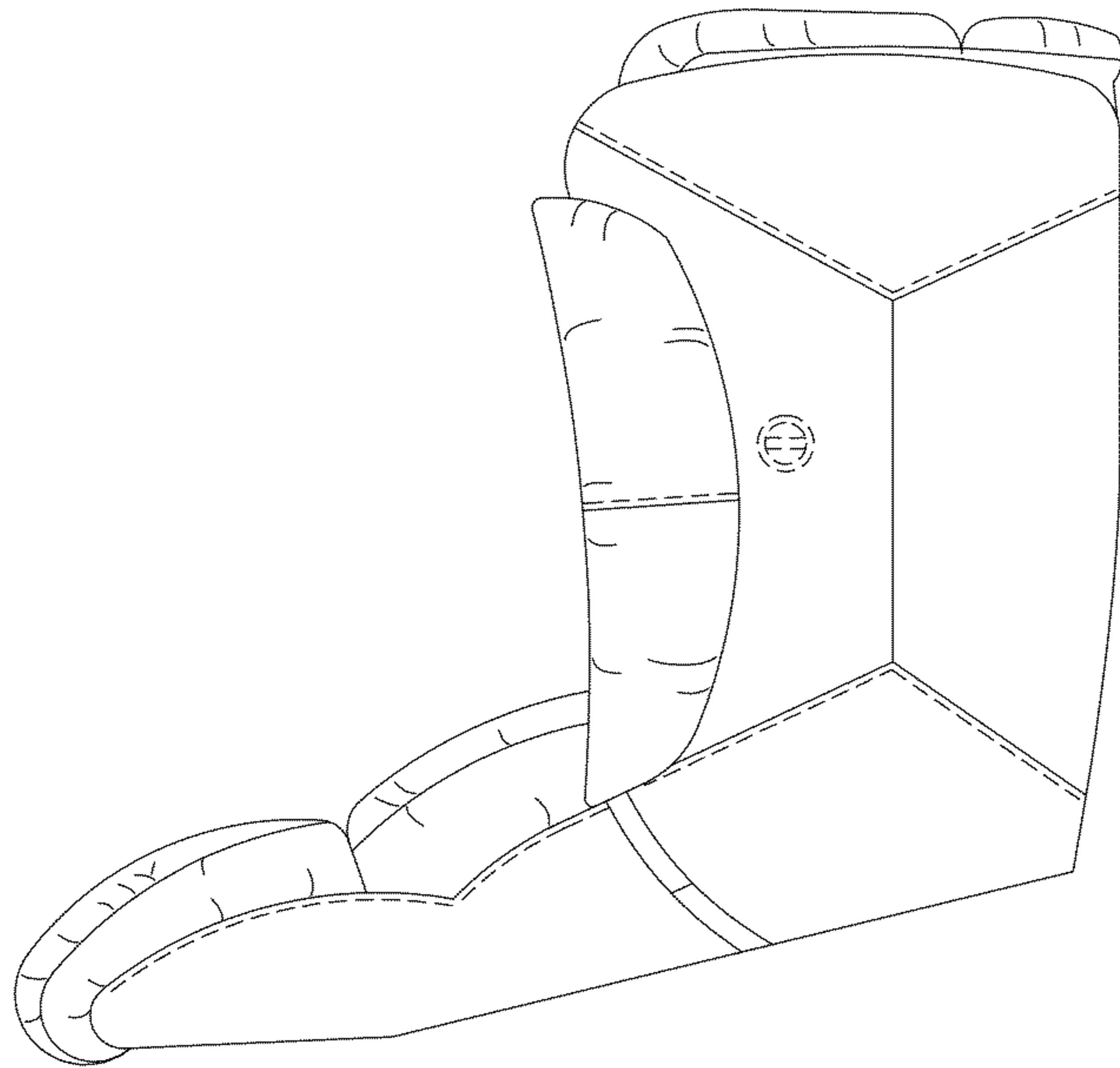

FIG. 5

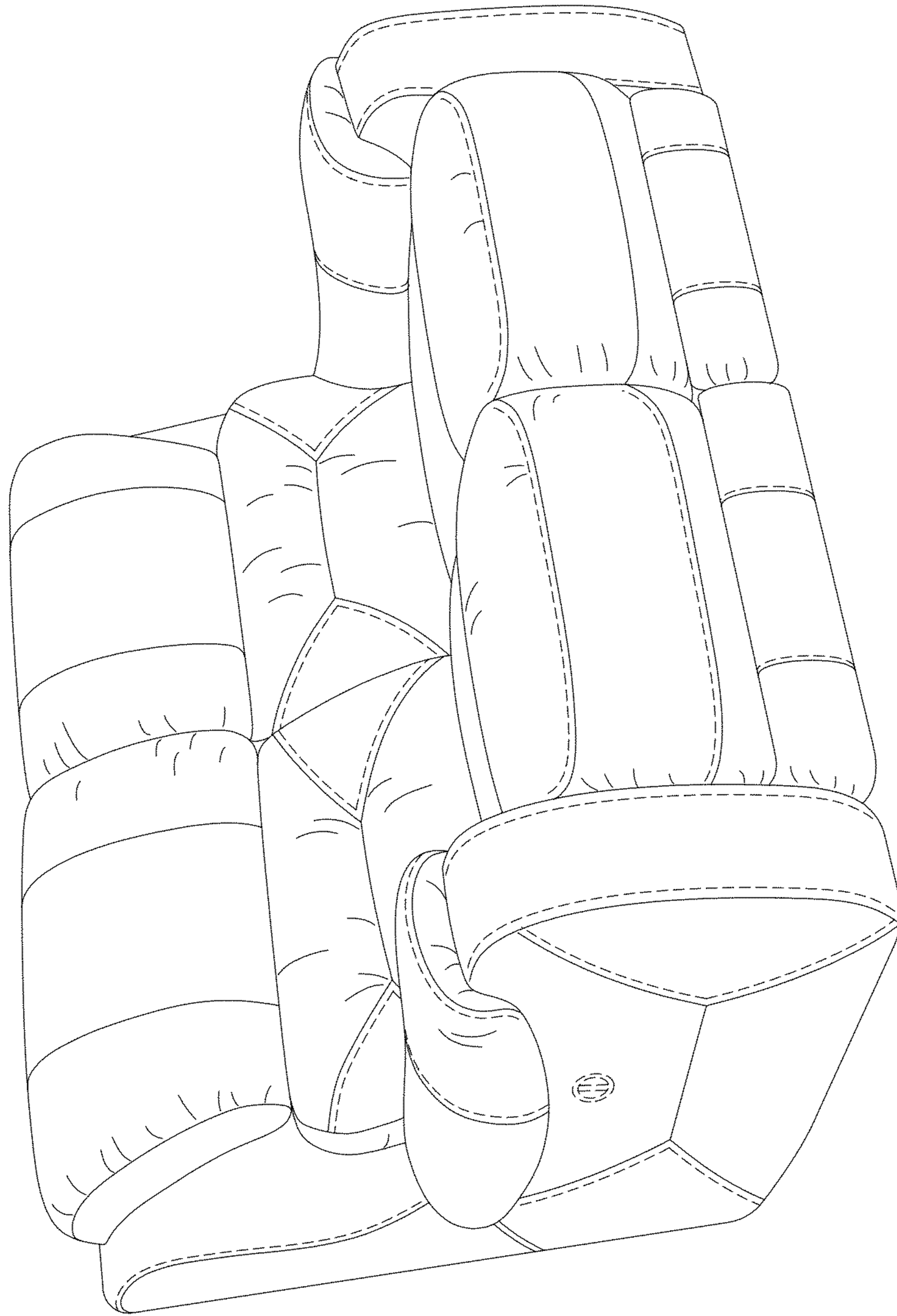

FIG. 6

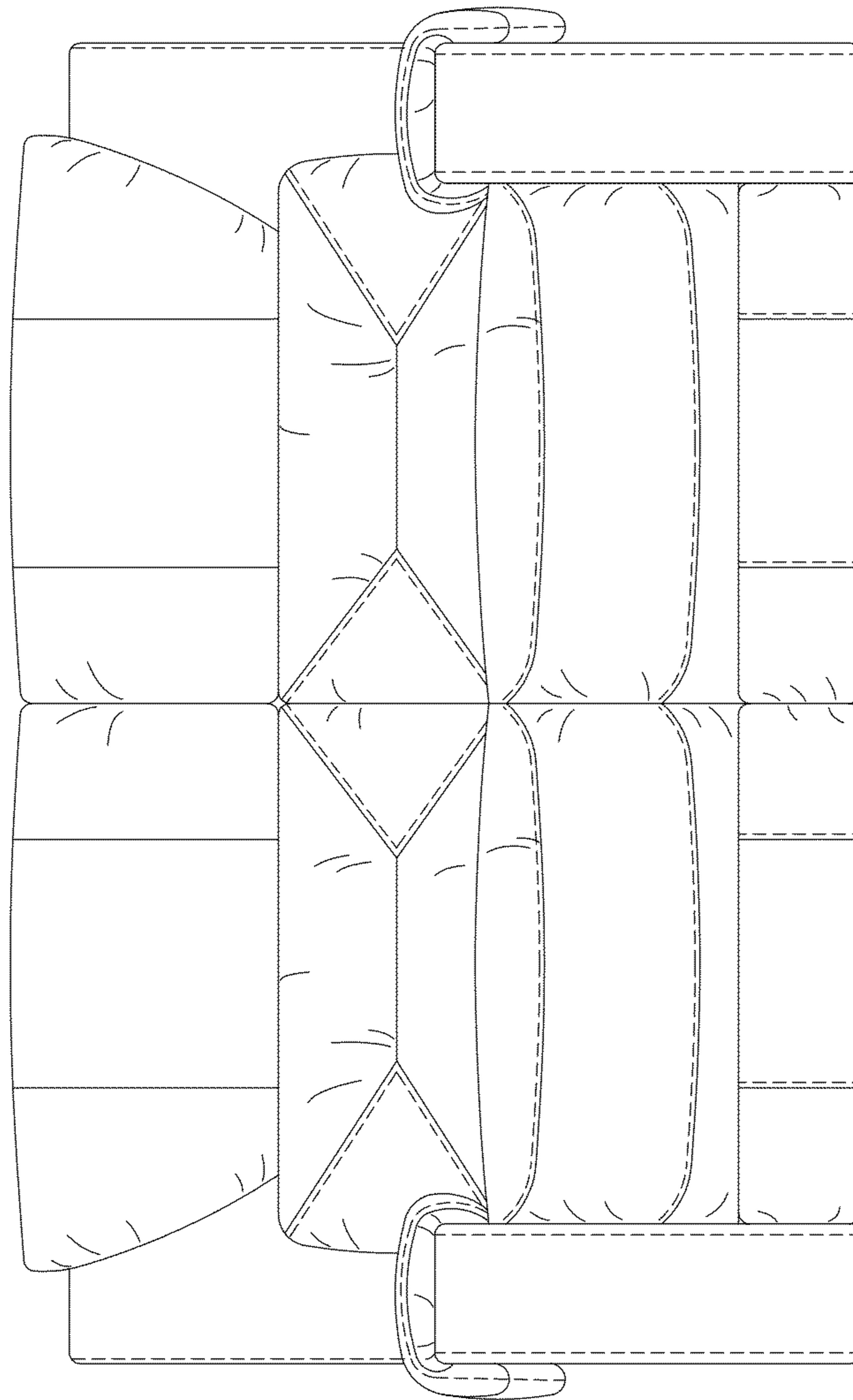

FIG. 7

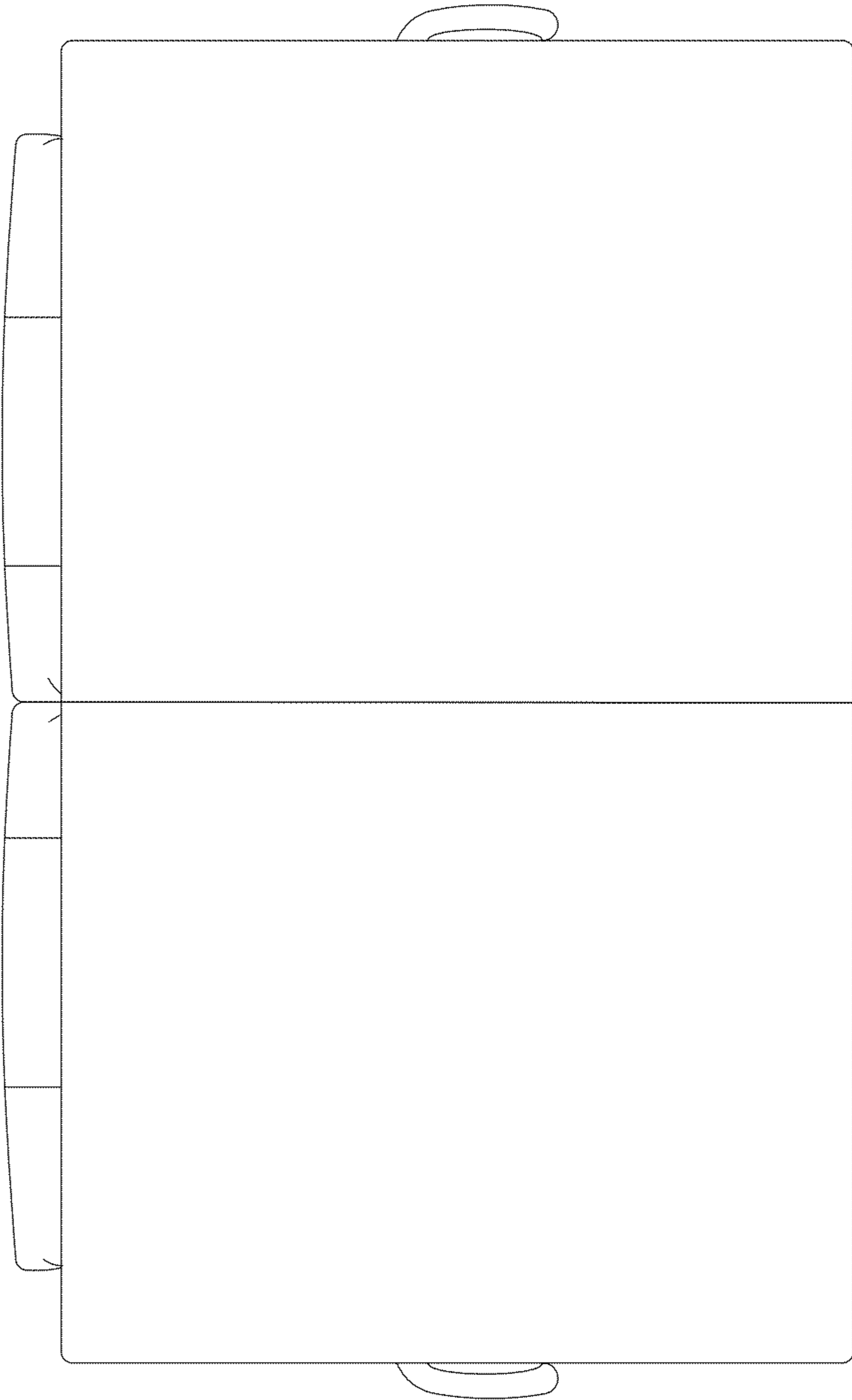

FIG. 8

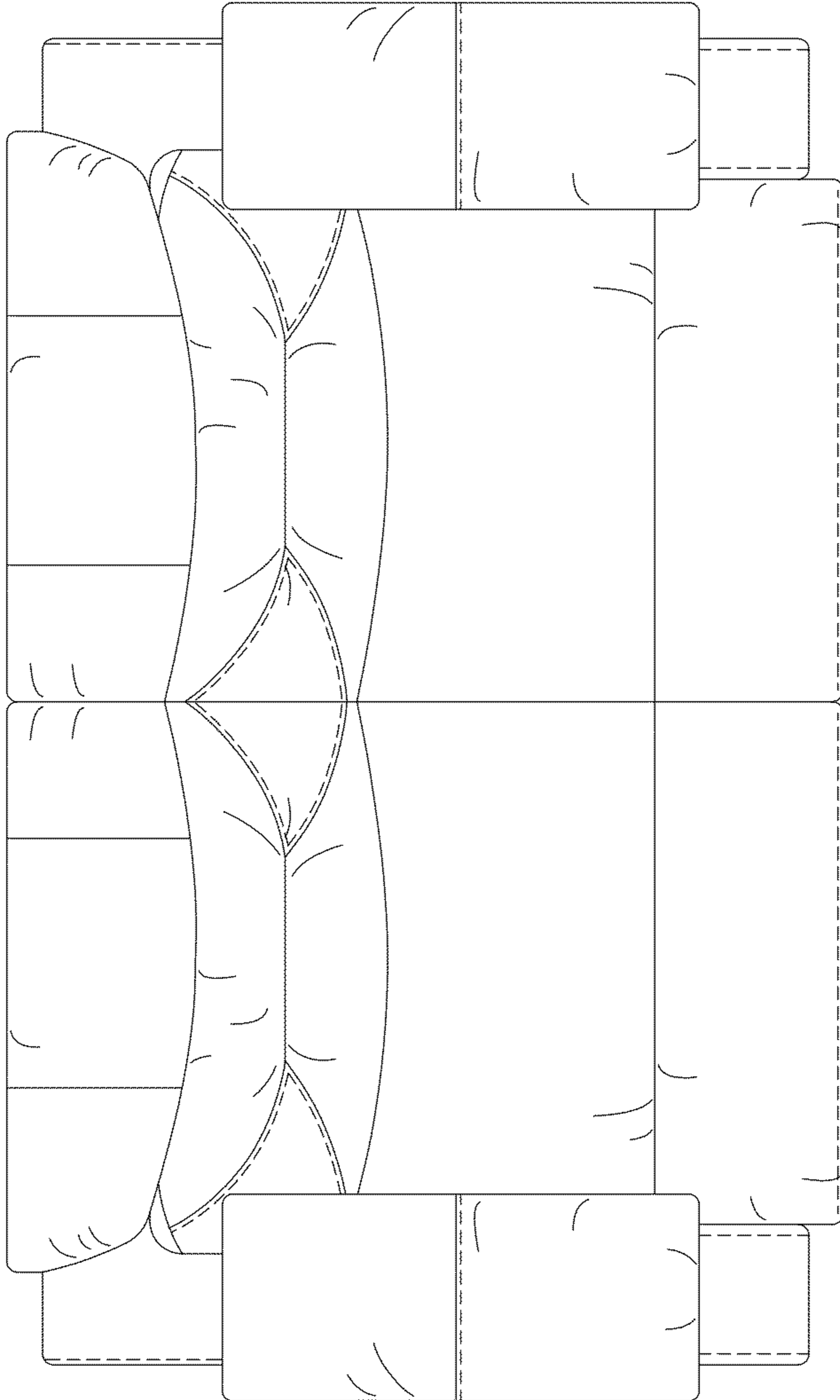

FIG. 9

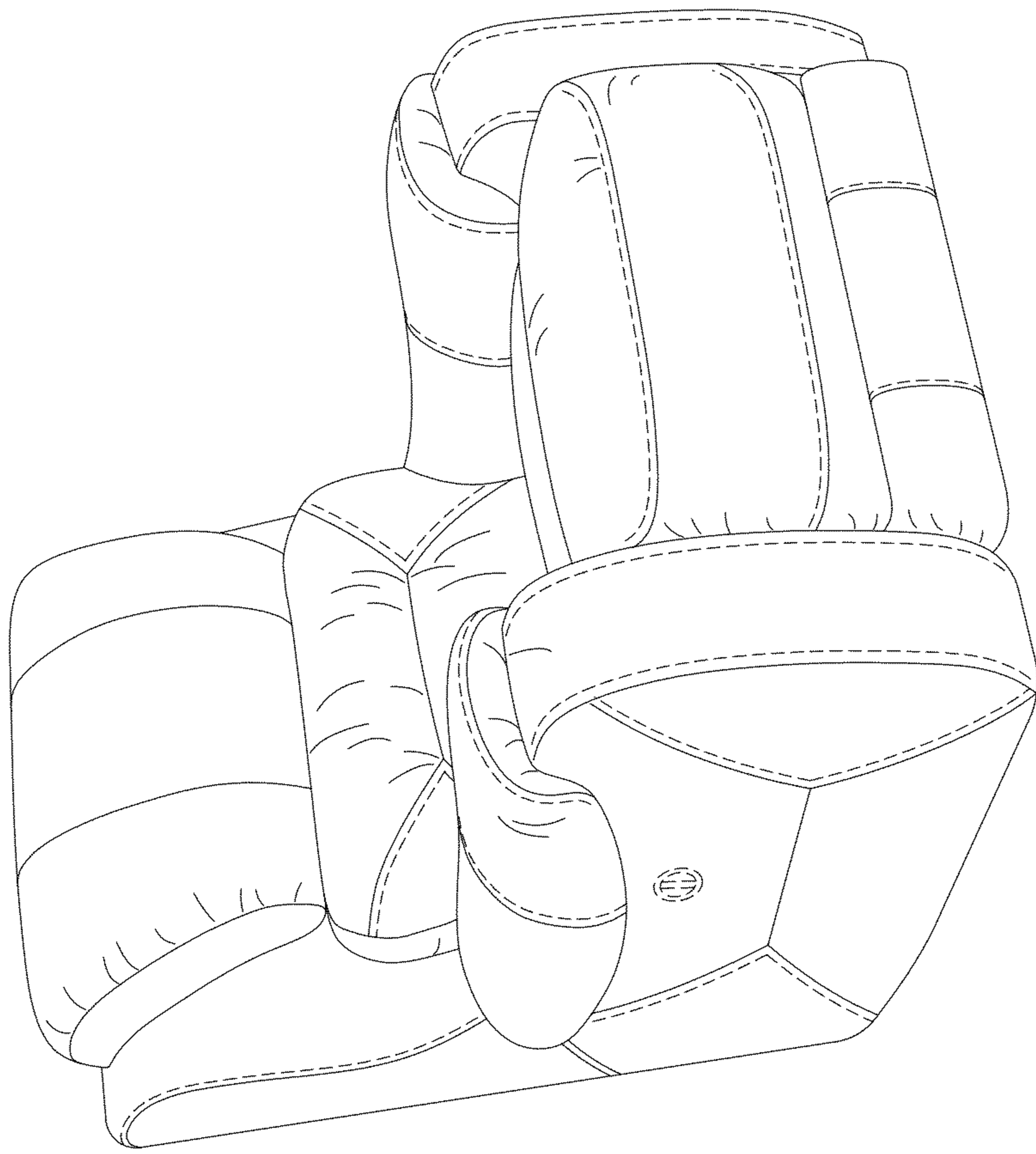

FIG. 10

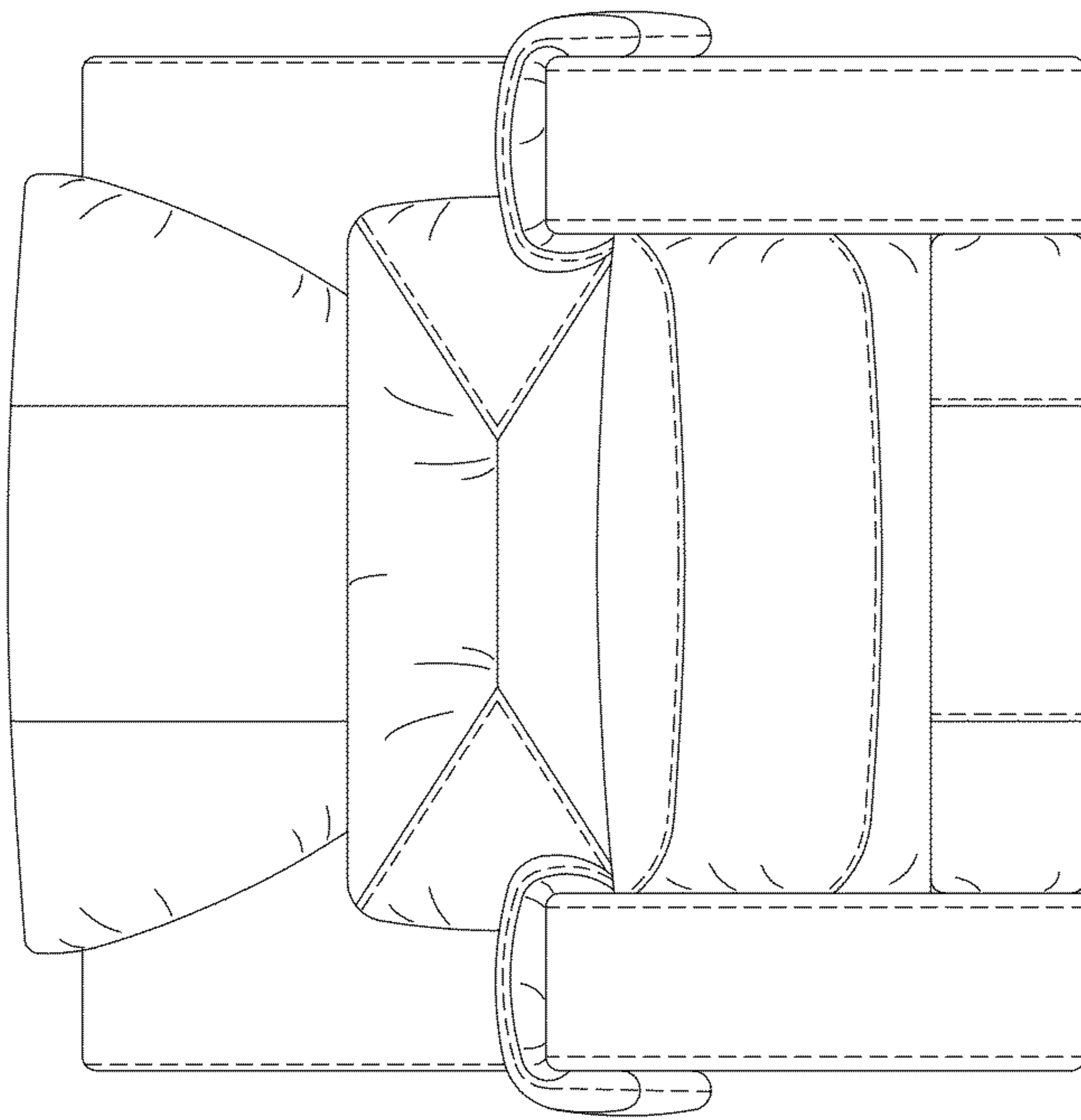

FIG. 11

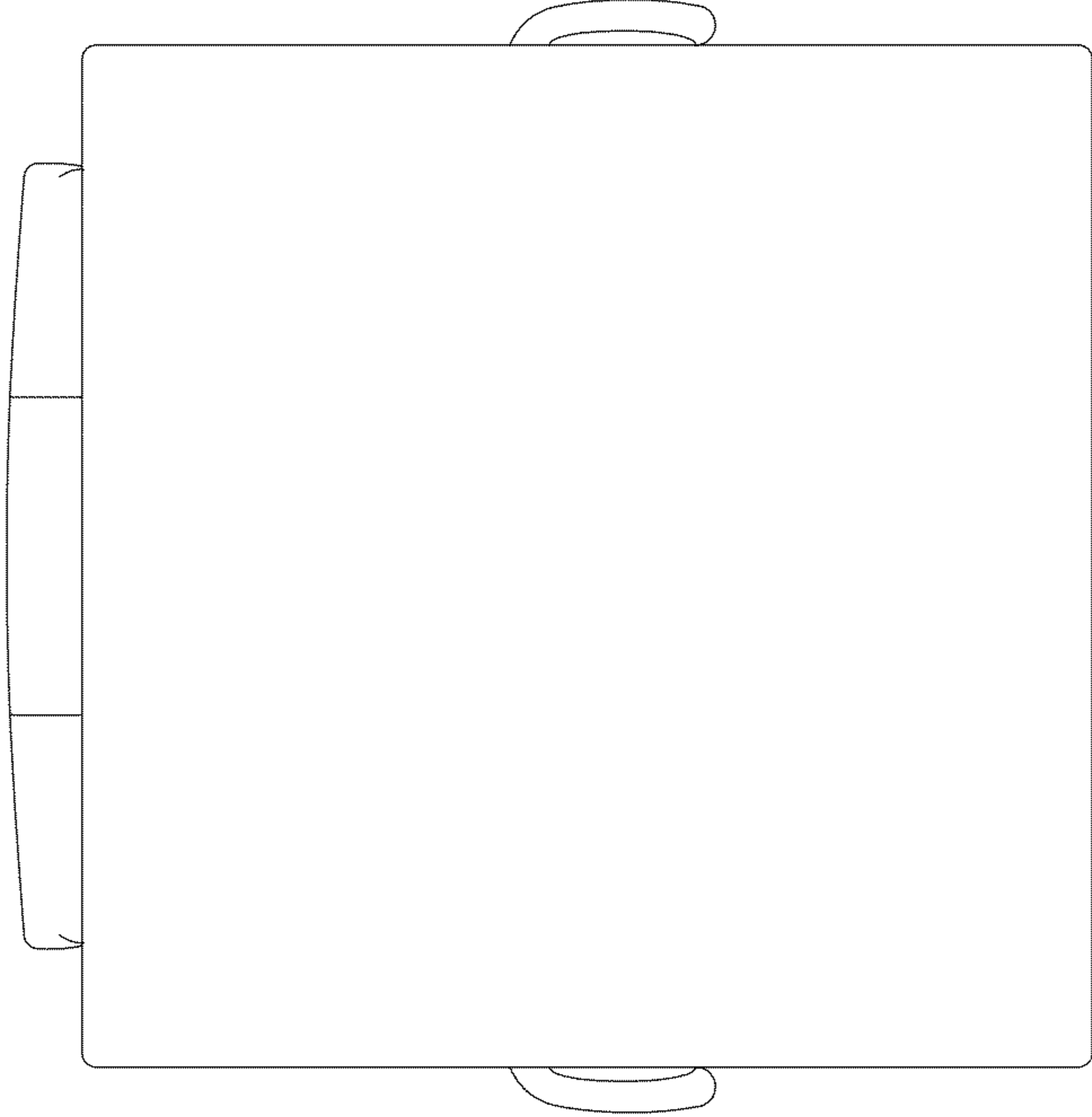

FIG. 12

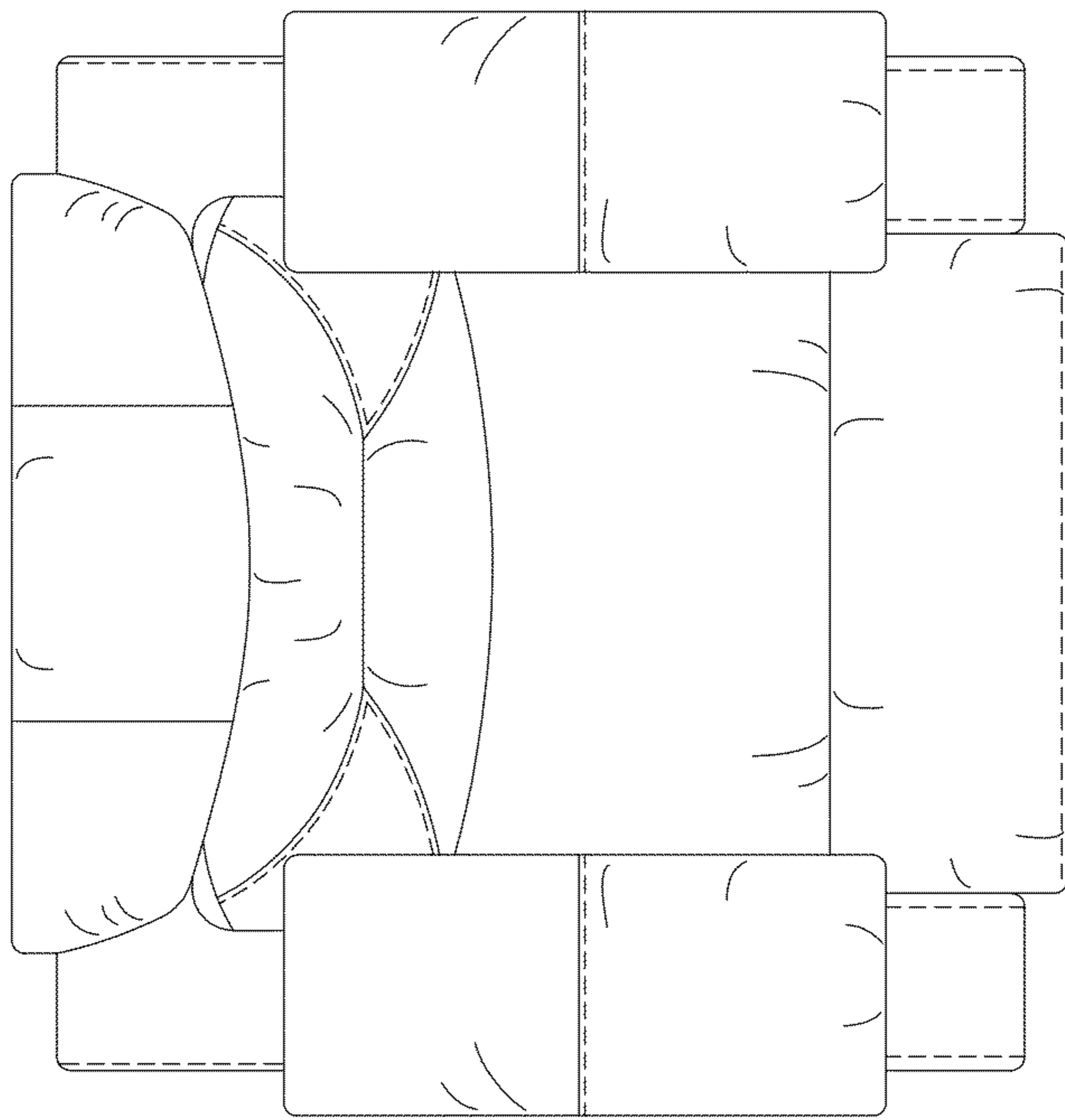

FIG. 13