



US00D742073S

(12) **United States Design Patent**  
**Zamolo et al.**

(10) **Patent No.:** **US D742,073 S**  
(45) **Date of Patent:** **\*\* Oct. 27, 2015**

- (54) **PRISONER RESTRAINT KIT**
- (71) Applicants: **Craig Zamolo**, Murphy's, CA (US);  
**Ronald O'Dell**, Danville, CA (US)
- (72) Inventors: **Craig Zamolo**, Murphy's, CA (US);  
**Ronald O'Dell**, Danville, CA (US)
- (73) Assignee: **SAFE RESTRAINTS, INC.**, Walnut  
Creek, CA (US)
- (\*\*) Term: **14 Years**
- (21) Appl. No.: **29/488,952**
- (22) Filed: **Apr. 24, 2014**
- (51) **LOC (10) Cl.** ..... **29-02**
- (52) **U.S. Cl.**  
USPC ..... **D29/100**
- (58) **Field of Classification Search**  
USPC ..... D29/100-101.5, 120.1, 120.2, 113;  
2/16, 17, 170; 24/16 PB; 70/14-19;  
119/770; 128/869, 878  
CPC ..... E05B 75/00  
See application file for complete search history.

7,581,416 B1 \* 9/2009 Lenertz ..... 70/16  
7,942,152 B1 \* 5/2011 Foster et al. .... 128/879  
8,056,927 B2 \* 11/2011 Singh ..... 280/806

\* cited by examiner

*Primary Examiner* — Randall Gholson

(57) **CLAIM**

The ornamental design for a prisoner restraint kit, as shown and described.

**DESCRIPTION**

FIG. 1 is front view of an upper harness part of the prisoner restraint kit of my design placed into an elevated position. FIG. 2 is a rear view thereof. FIG. 3 is a front view of an upper harness part of the prisoner restraint kit of my design. FIG. 4 is a rear view thereof. FIG. 5 is a bottom view thereof. FIG. 6 is a top view thereof. FIG. 7 is a left and right side view thereof. FIG. 8 is a front view of a lower harness part of the prisoner restraint kit of my design. FIG. 9 is a rear view thereof. FIG. 10 is a left side view thereof. FIG. 11 is a right side view thereof. FIG. 12 is a top view thereof. FIG. 13 is a bottom view thereof. FIG. 14 is the upper harness part of FIG. 9 and the lower harness part of FIG. 8 shown together as the prisoner restraint kit of my design. FIG. 15 is a front view of a hobble part of the prisoner restraint kit of my design. FIG. 16 is a side view thereof; and, FIG. 17 is a bottom view thereof. Portions of the prisoner restraint kit are shown separately for ease of illustration. The broken lines depict portions of the prisoner restraint kit that form no part of the claimed design.

(56) **References Cited**

**U.S. PATENT DOCUMENTS**

4,971,073 A \* 11/1990 Schneider ..... 128/874  
5,211,186 A \* 5/1993 Shoemaker et al. .... 5/628  
5,662,326 A \* 9/1997 Gebran ..... 273/239  
5,699,747 A 12/1997 O'Dell et al.  
5,728,059 A \* 3/1998 Wiesemann et al. .... 602/64  
5,829,443 A \* 11/1998 Cunningham ..... 128/869  
5,893,366 A \* 4/1999 Odell et al. .... 128/869  
D417,753 S \* 12/1999 Wiley ..... D29/101.1  
6,857,430 B2 \* 2/2005 Morris ..... 128/869  
7,266,850 B1 \* 9/2007 Strum et al. .... 2/2.5

**1 Claim, 10 Drawing Sheets**

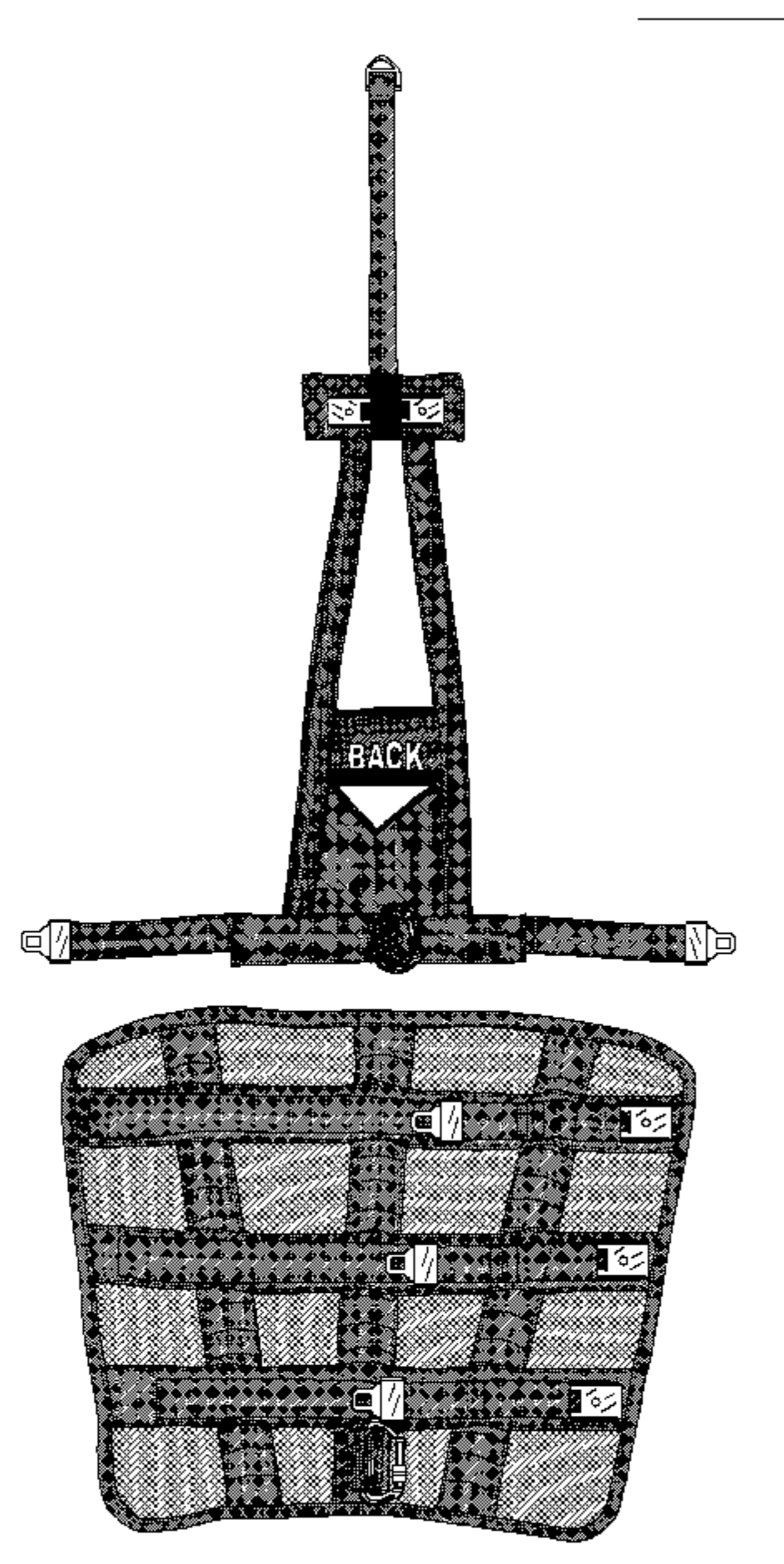

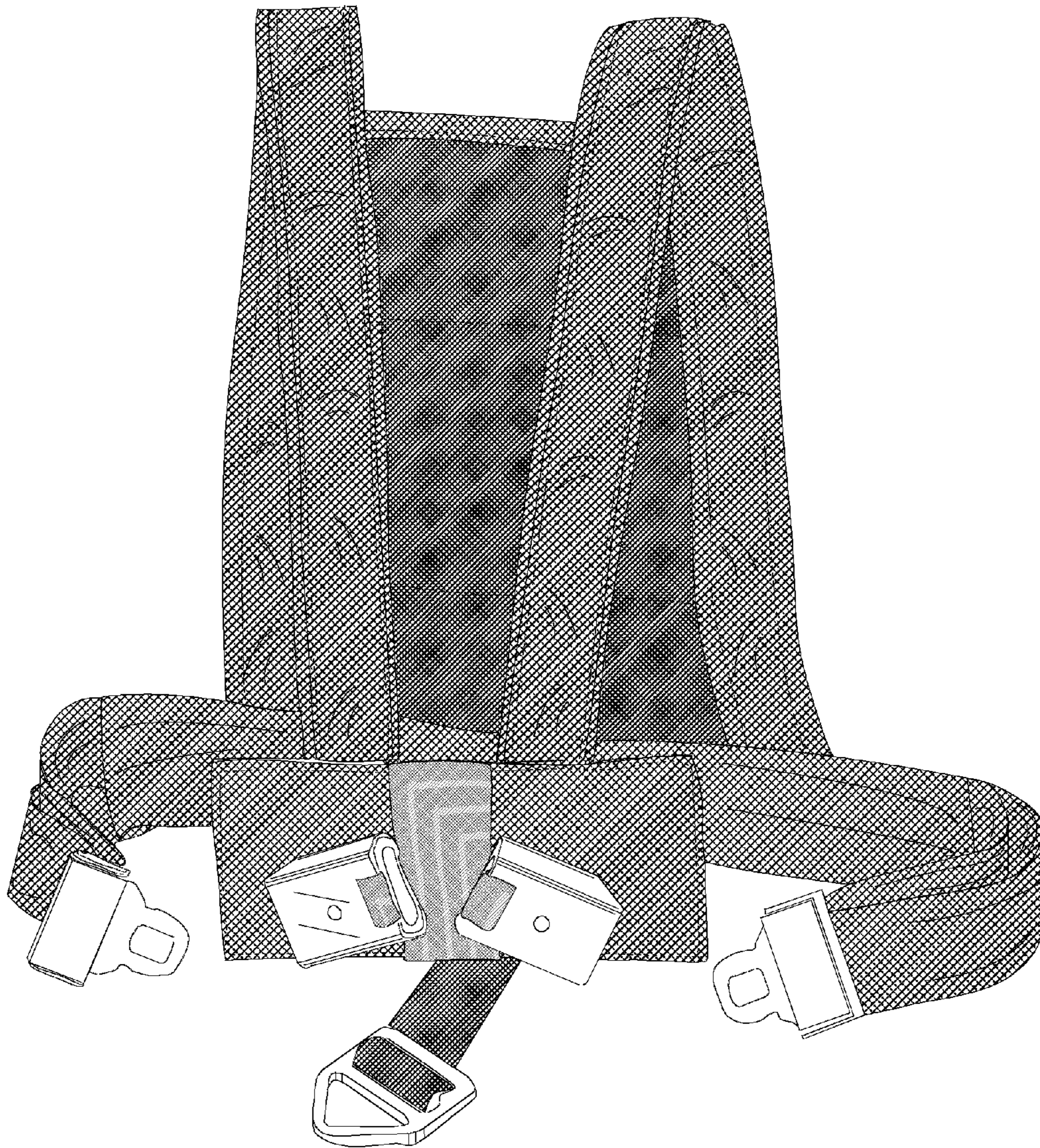

FIG. 1

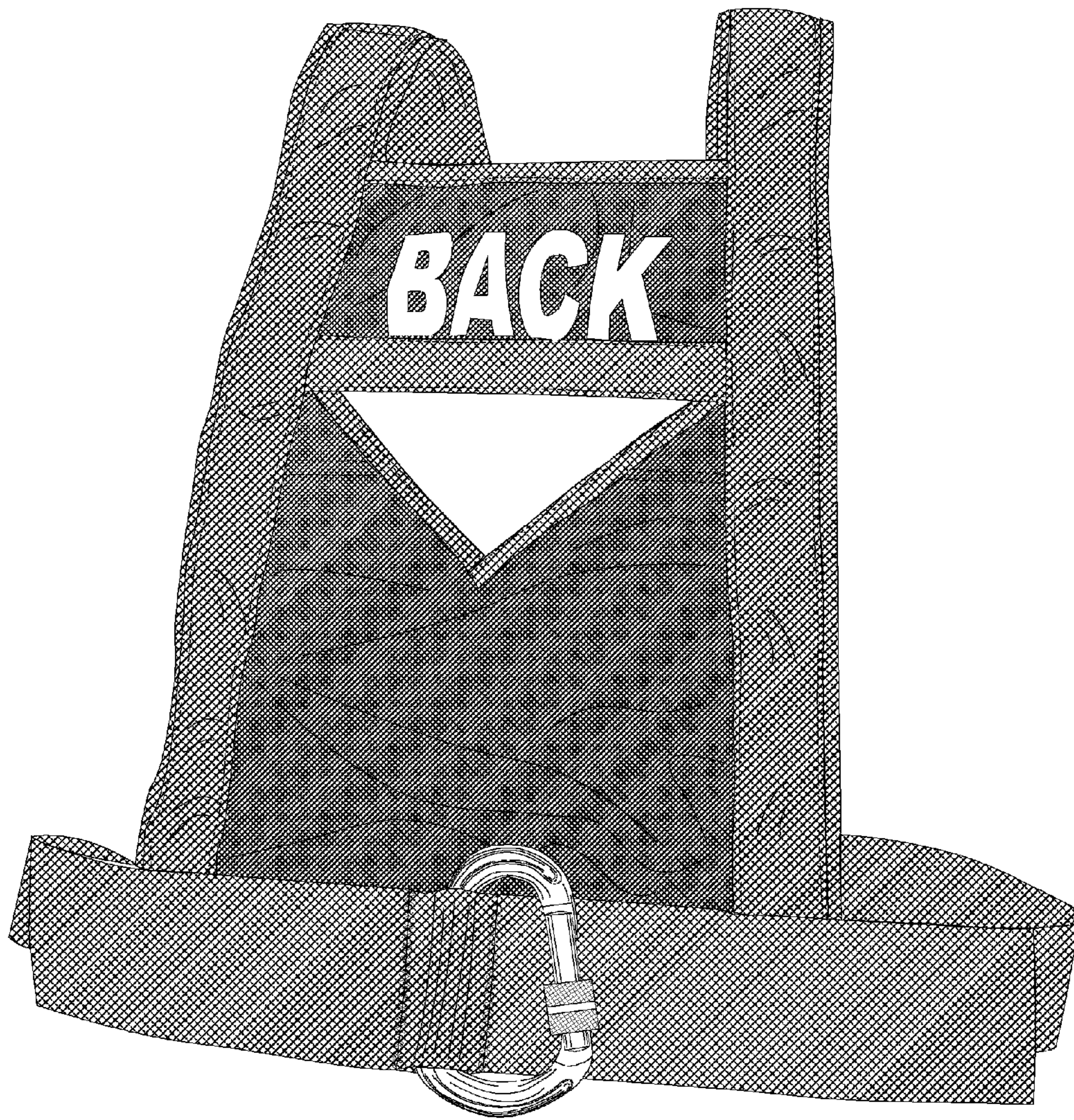

FIG. 2

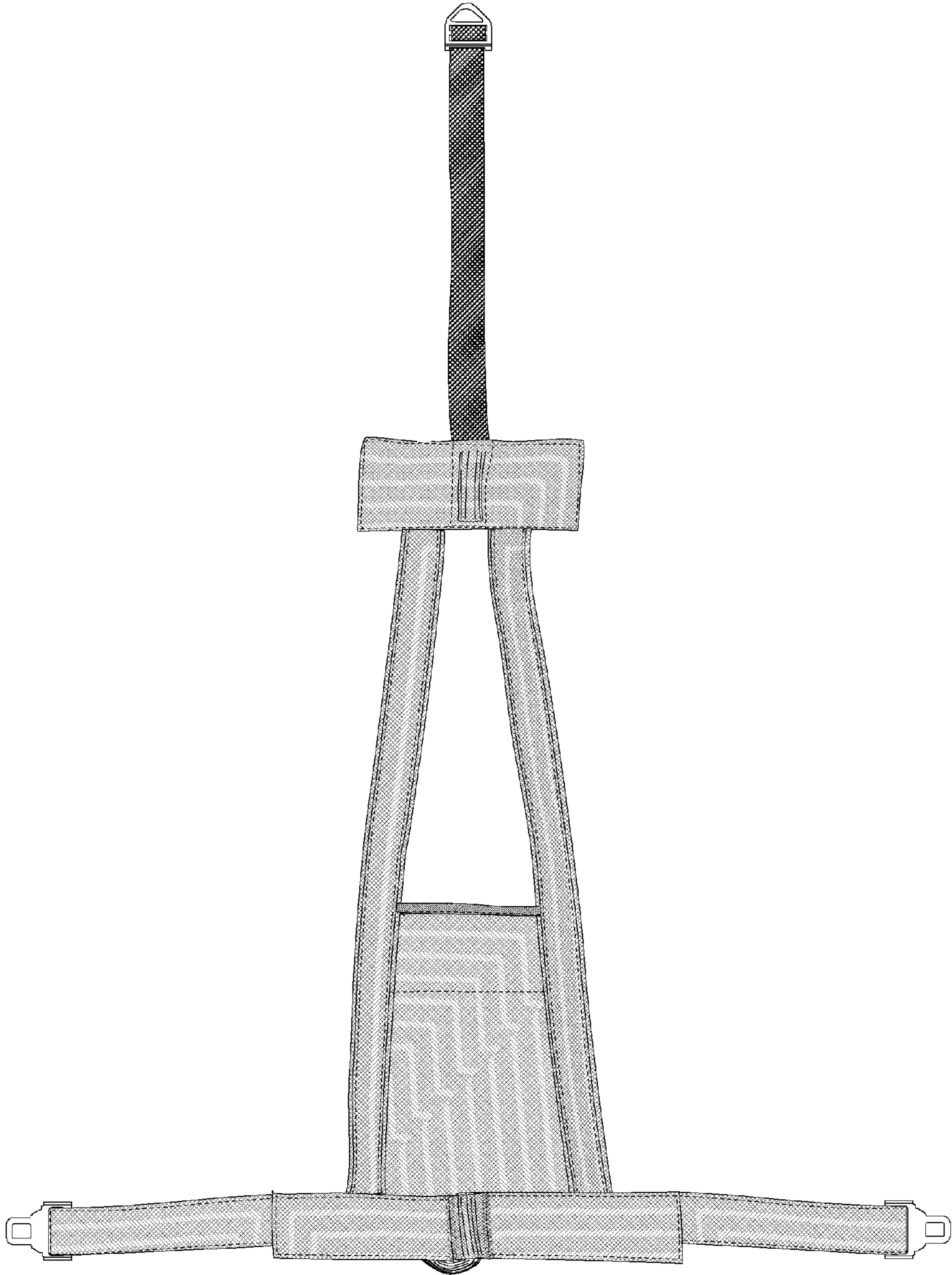

FIG. 3

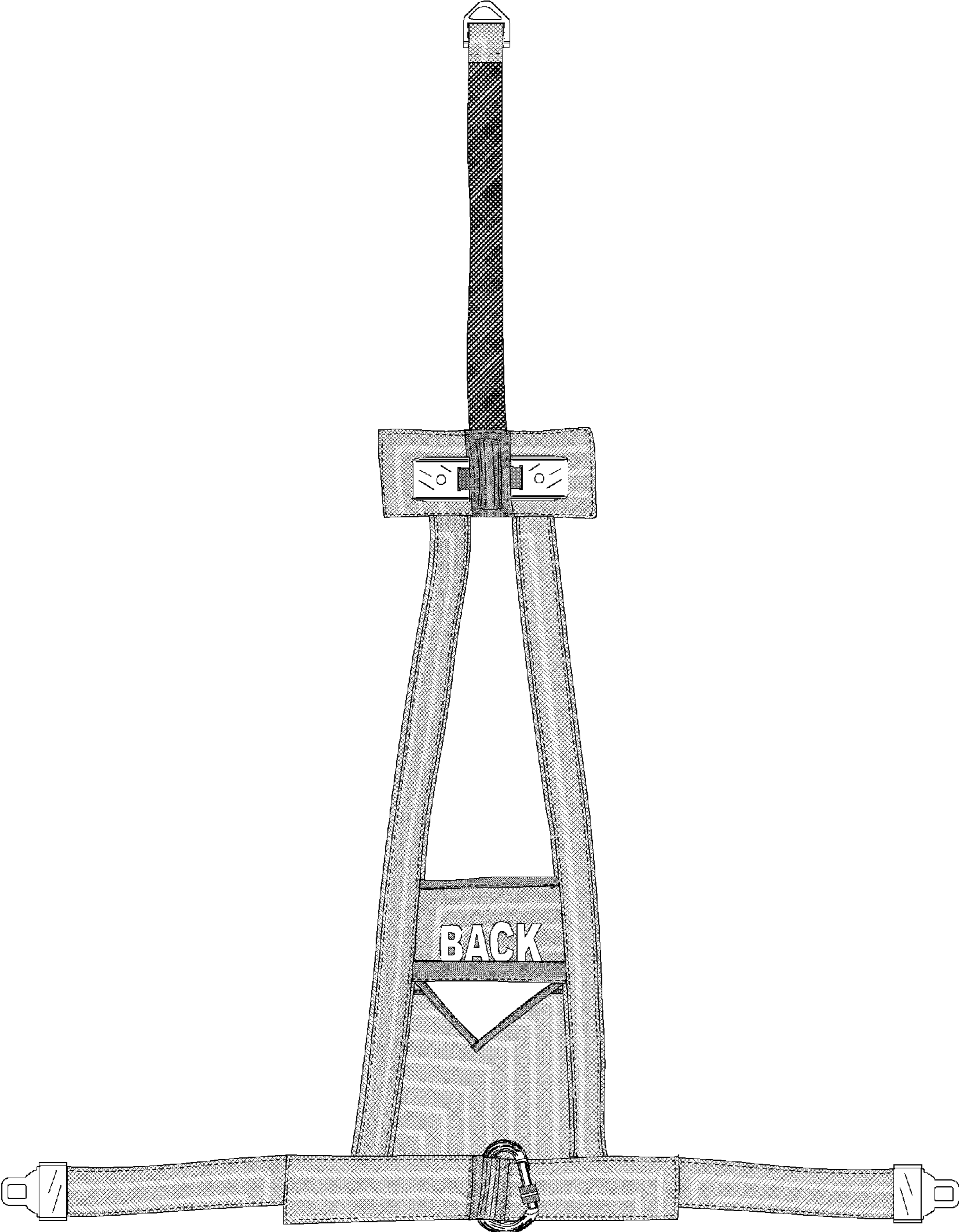

FIG. 4



FIG. 5



FIG. 6



FIG. 7



FIG. 8

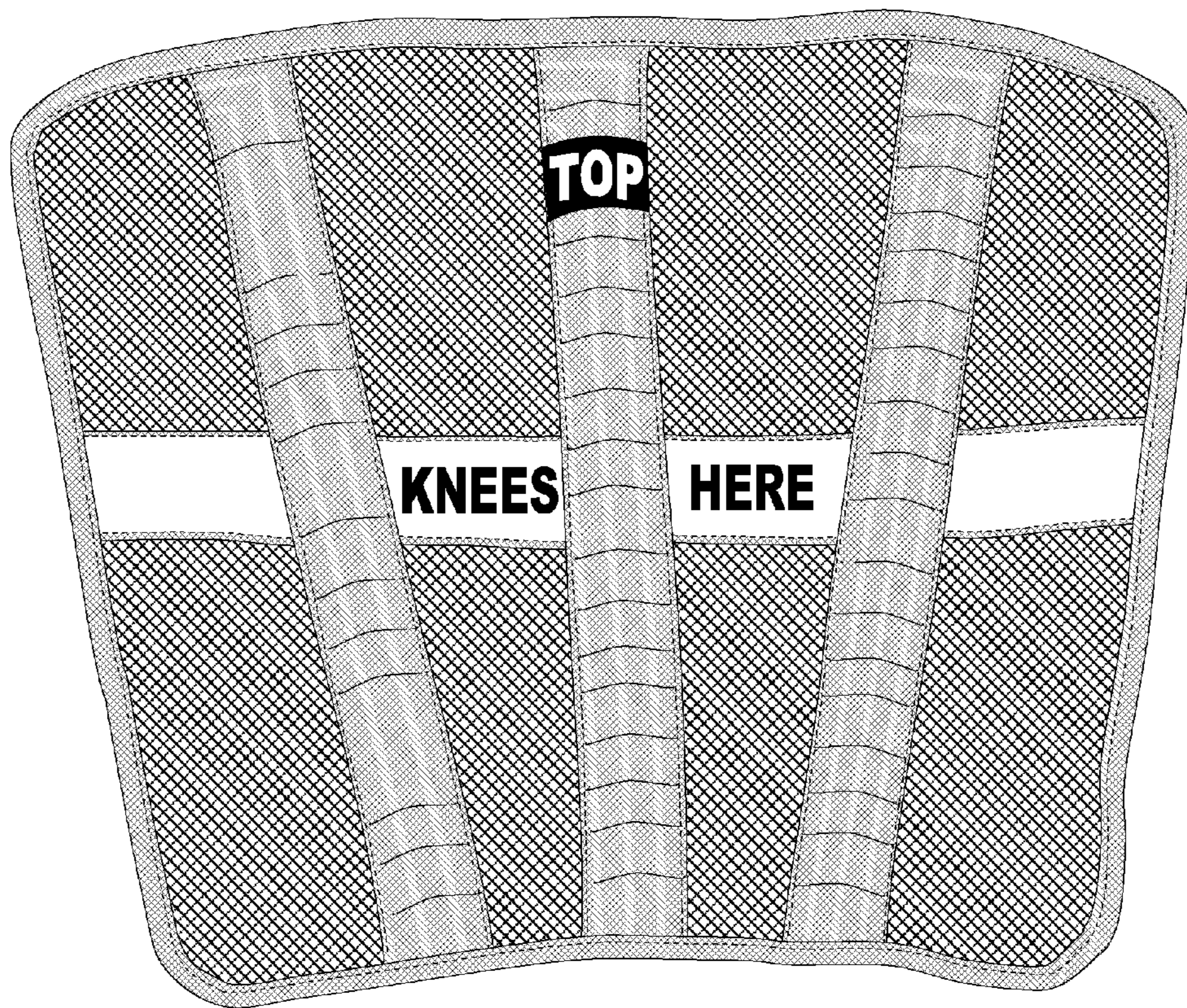

FIG. 9



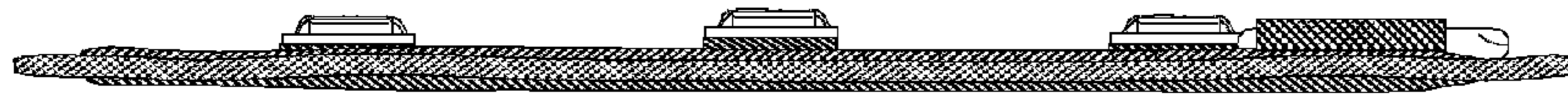

FIG. 10

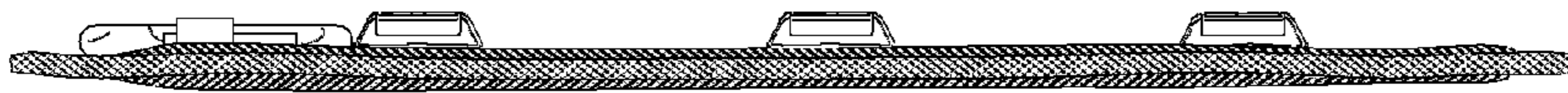

FIG. 11



FIG. 12

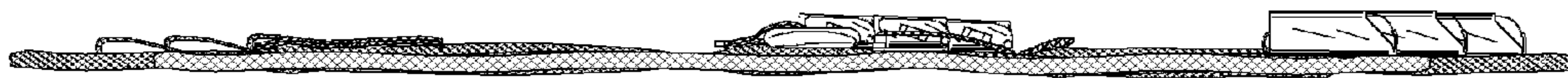

FIG. 13

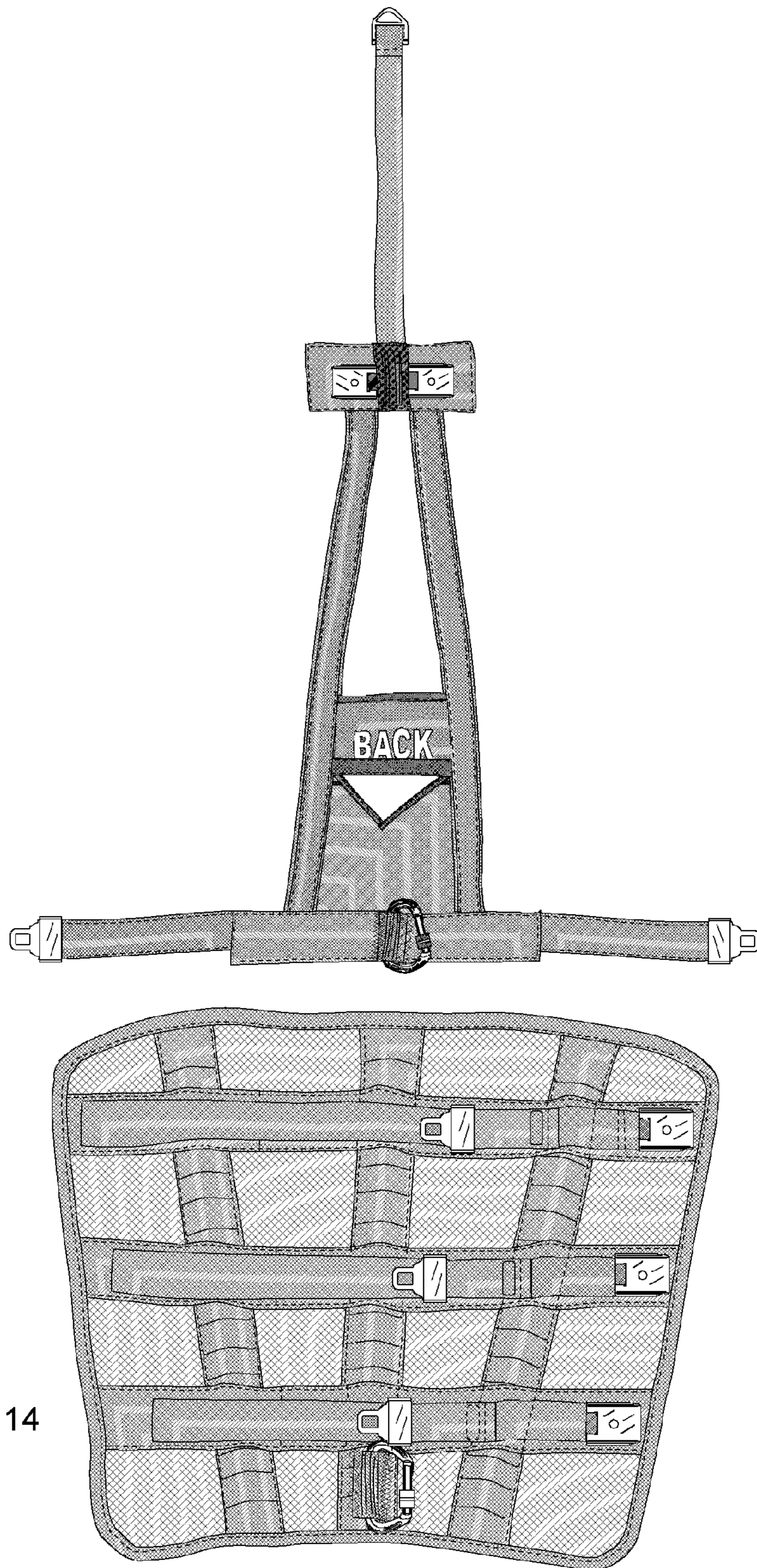

FIG. 14

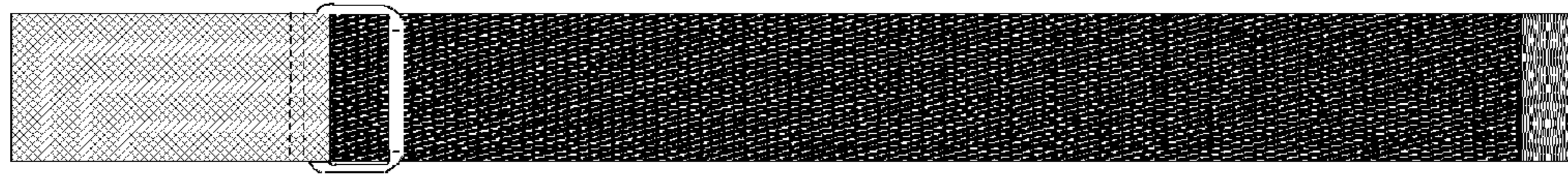

FIG. 15



FIG. 16

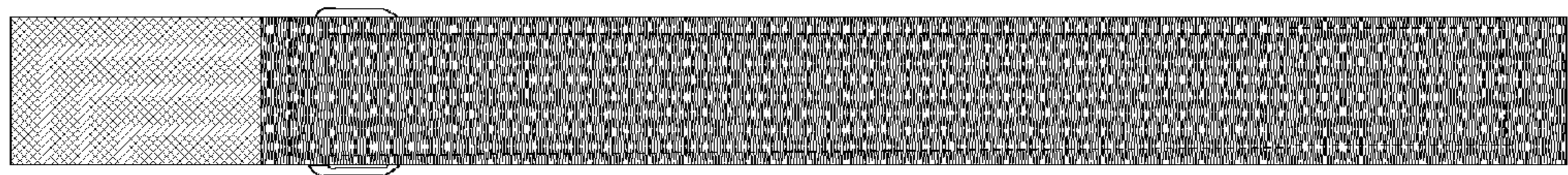

FIG. 17