



US00D741974S

(12) **United States Design Patent**
Lung

(10) **Patent No.:** **US D741,974 S**
(45) **Date of Patent:** **** Oct. 27, 2015**

(54) **GYMNASTICS GRIP BAND ACCESSORY**

(71) Applicant: **Chris Lung**, Waltham, MA (US)

(72) Inventor: **Chris Lung**, Waltham, MA (US)

(**) Term: **14 Years**

(21) Appl. No.: **29/465,438**

(22) Filed: **Aug. 28, 2013**

(51) **LOC (10) Cl.** **21-02**

(52) **U.S. Cl.**
USPC **D21/797**; D21/698

(58) **Field of Classification Search**
USPC D21/797, 694, 753; 482/23, 139, 37,
482/49, 44, 47, 93; D29/113, 114; 473/205,
473/212, 300, 464; D2/617
CPC A63B 2208/12; A63B 21/1438; A63B
21/1442; A63B 71/14; A63B 69/187; A63B
2209/10; A63B 21/10724; A63B 59/0025;
A63B 71/00; A63B 1/00; A63B 21/0552;
A63B 43/005; A63B 69/00; Y10S 2/917;
Y10S 482/90

See application file for complete search history.

(56) **References Cited**

U.S. PATENT DOCUMENTS

3,496,573	A *	2/1970	Pope et al.	2/161.6
3,945,045	A *	3/1976	Rhee	2/16
D275,219	S *	8/1984	Scales, Jr.	D29/120.1
D285,821	S *	9/1986	Kneisley	D29/120.1
4,720,279	A *	1/1988	Fritschen et al.	441/69
4,754,499	A *	7/1988	Pirie	2/20
5,081,715	A *	1/1992	Mascia	2/20
D331,042	S *	11/1992	Hassel et al.	D14/460
D340,990	S *	11/1993	Kawamura	D24/190
5,298,001	A *	3/1994	Goodson	482/23
5,353,440	A *	10/1994	Meldeau	2/161.1
5,770,297	A *	6/1998	Grubich	428/99
5,846,168	A *	12/1998	Murray	482/105
5,898,944	A *	5/1999	Vrany	2/161.4
6,666,795	B2 *	12/2003	Mah	482/23
6,898,802	B1 *	5/2005	Suarkeo	2/20
7,008,355	B2 *	3/2006	Emick	482/139
D650,530	S *	12/2011	Padin	D29/117.1

D665,089	S *	8/2012	Brown	D24/190
8,267,844	B2 *	9/2012	Kassel et al.	482/139
2003/0199364	A1 *	10/2003	Mah	482/23
2005/0081273	A1 *	4/2005	Ota	2/17
2006/0084557	A1 *	4/2006	Kassel et al.	482/139
2011/0256992	A1 *	10/2011	Grafman et al.	482/139

FOREIGN PATENT DOCUMENTS

FR 2785820 A1 * 5/2000 A63B 71/14

OTHER PUBLICATIONS

Gynastics grip found [online] [Date searched Oct. 15, 2014]Internet
<URL:http://en.wikipedia.org/wiki/File:Bar_grip_front.jpg.*
Gymnastics grip found [online] [Date searched Oct. 15,
2014]Internet <URL:http://www.ueg.org/en/5th-European-Men-s-
and-Women-s-Artistic-Gymnastic-Individual-.*
Internet search URL<http://www.deitchgrips.com/detail.
php?item=6[date searched Apr. 15, 2015].*
Internet search URL<http://bakadoenterprises.com/images/
mensdarebarvelcro.jpg[date searched Apr. 13, 2015].*
Internet search URL<http://www.usglove.com/mens-elite-high-bar-
velcro-brand-fasteners-gymnastics-grips/[date searched Apr. 15,
2015].*

* cited by examiner

Primary Examiner — Philip S Hyder

Assistant Examiner — Keith Frank

(74) *Attorney, Agent, or Firm* — Bay State IP, LLC

(57) **CLAIM**

The ornamental design for a gymnastics grip band accessory,
as shown and described.

DESCRIPTION

FIG. 1 is a front side perspective view showing my new
design;
FIG. 2 is a front view thereof;
FIG. 3 is a back view thereof;
FIG. 4 is a side view thereof;
FIG. 5 is a side view thereof;
FIG. 6 is a top view thereof; and,
FIG. 7 is a bottom view thereof.

1 Claim, 4 Drawing Sheets

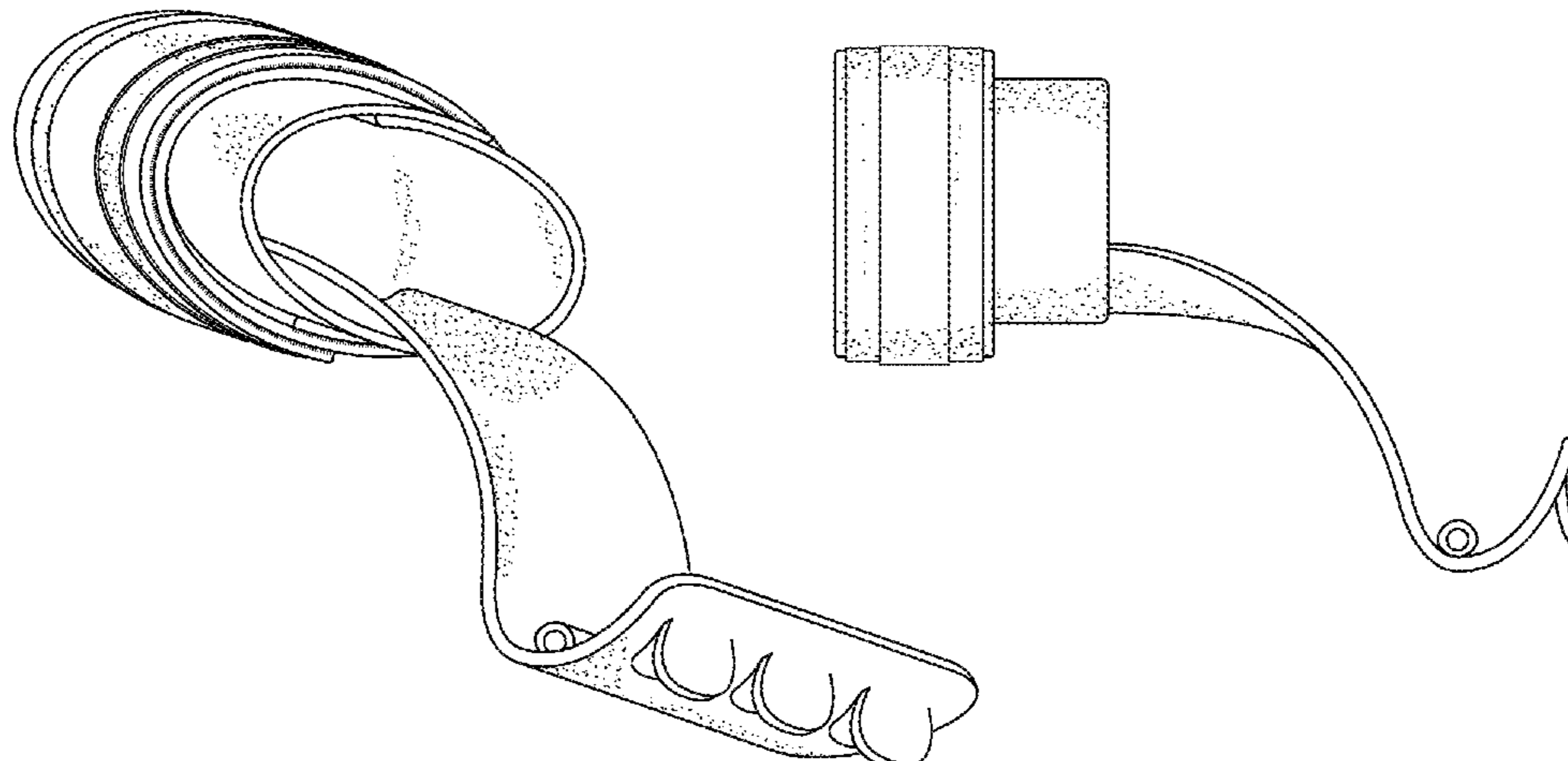

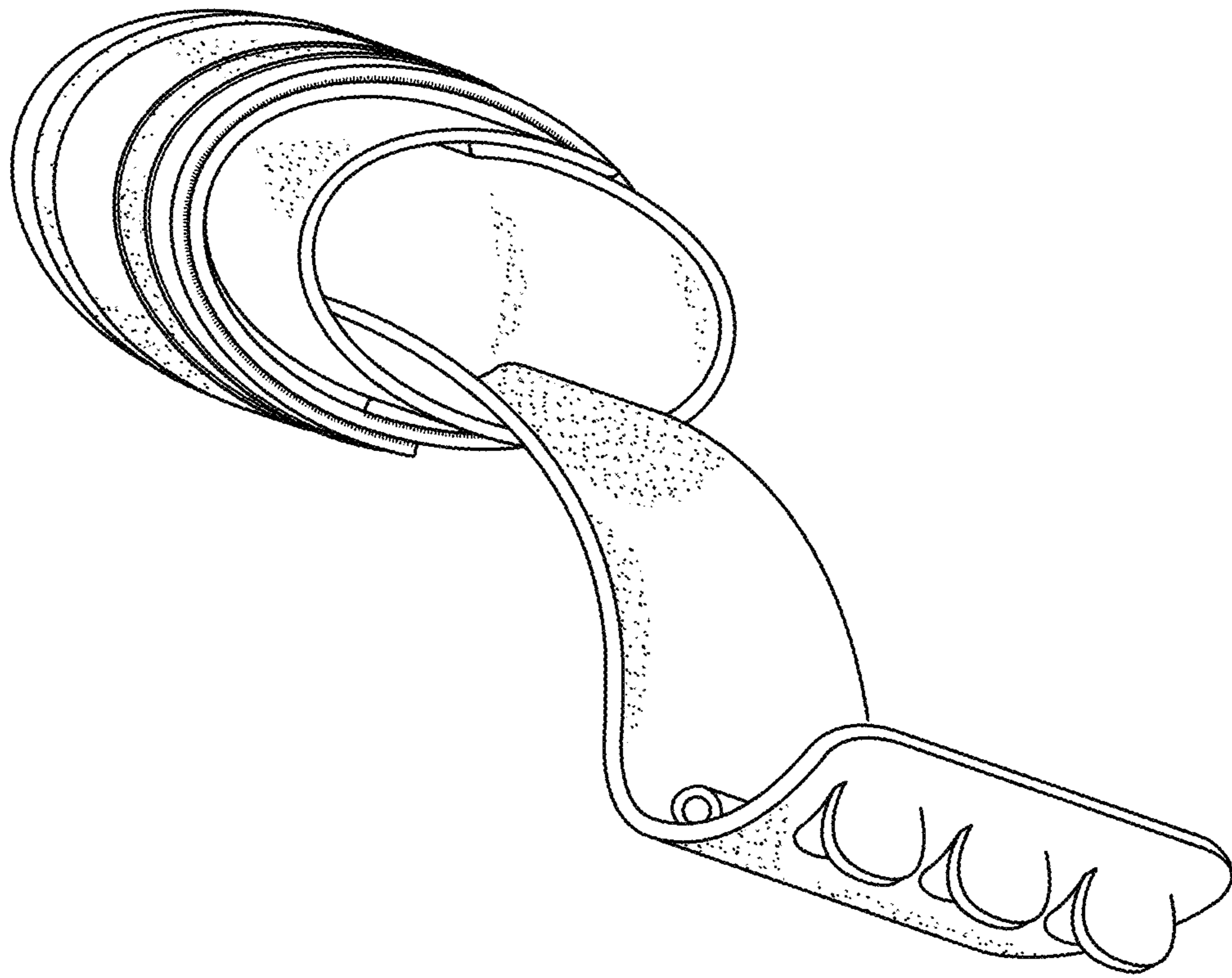

Fig. 1

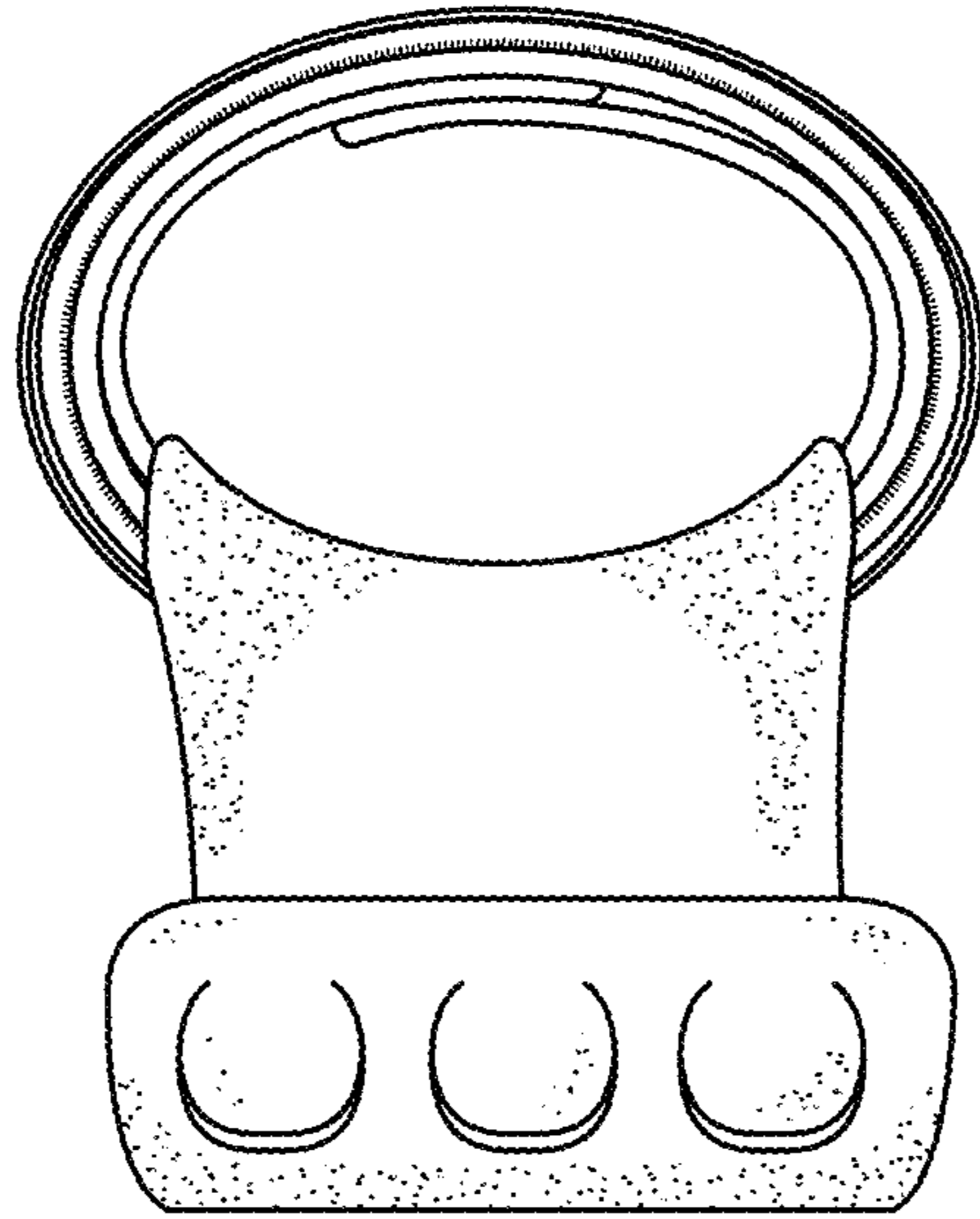

Fig. 2

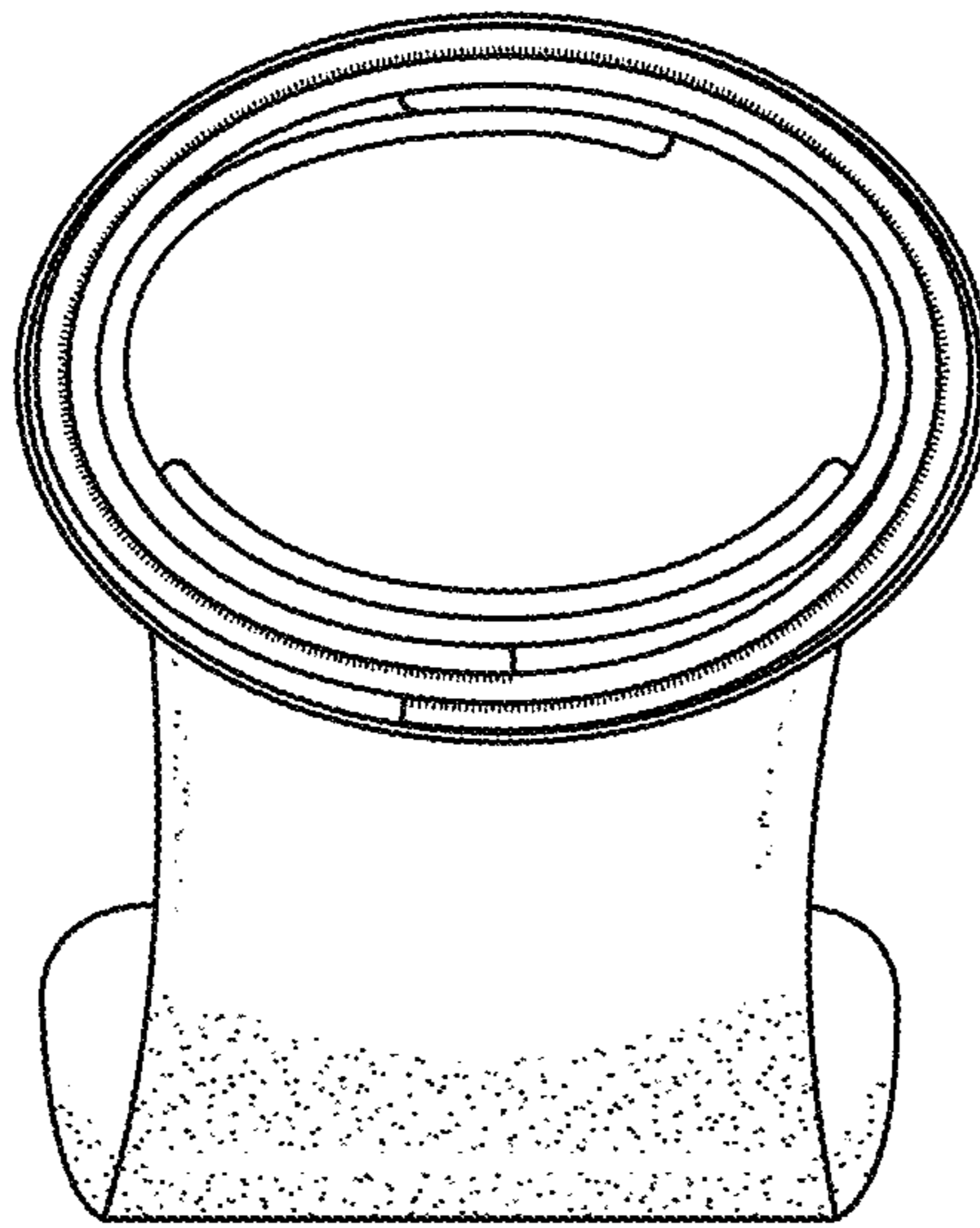

Fig. 3

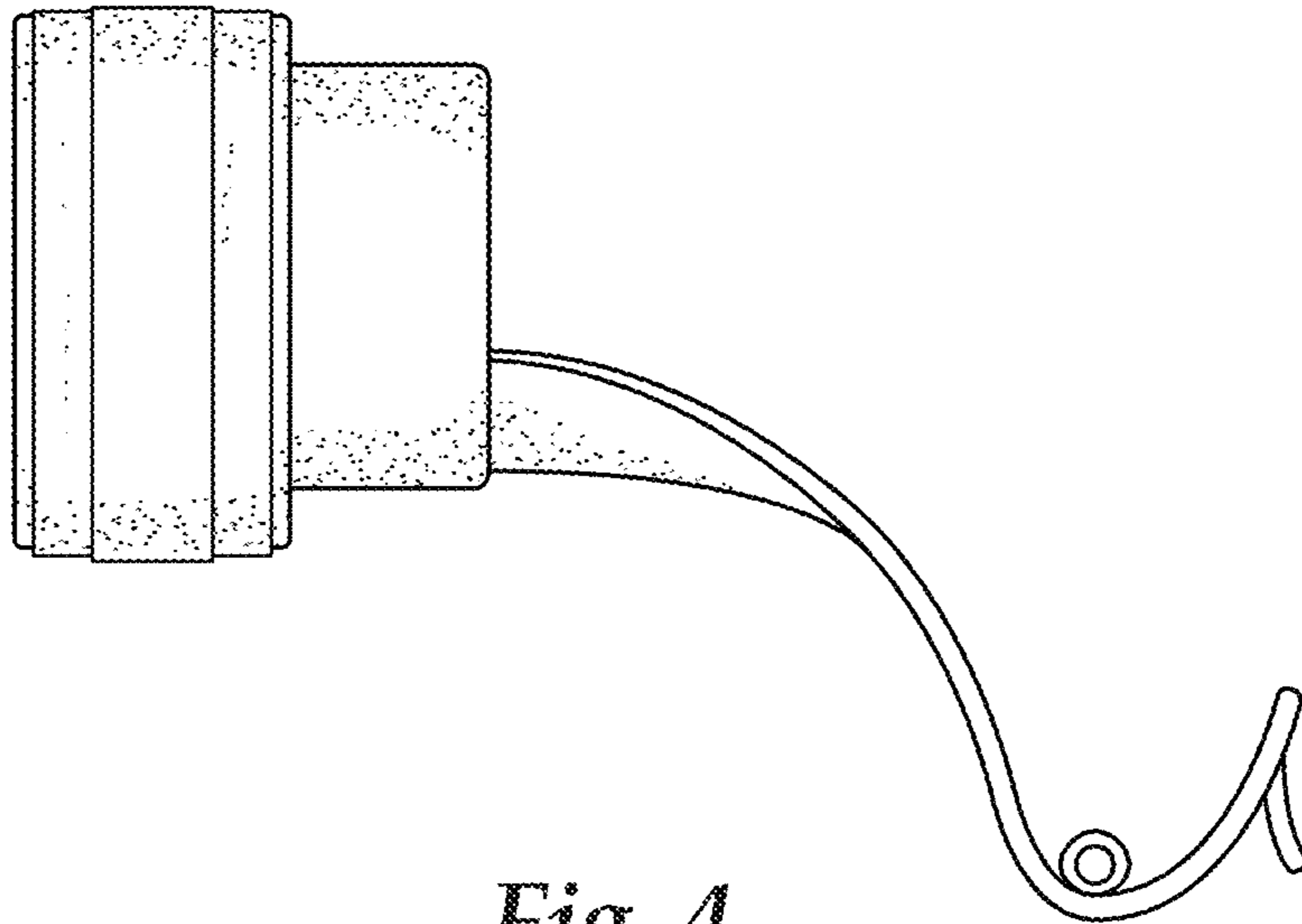

Fig. 4

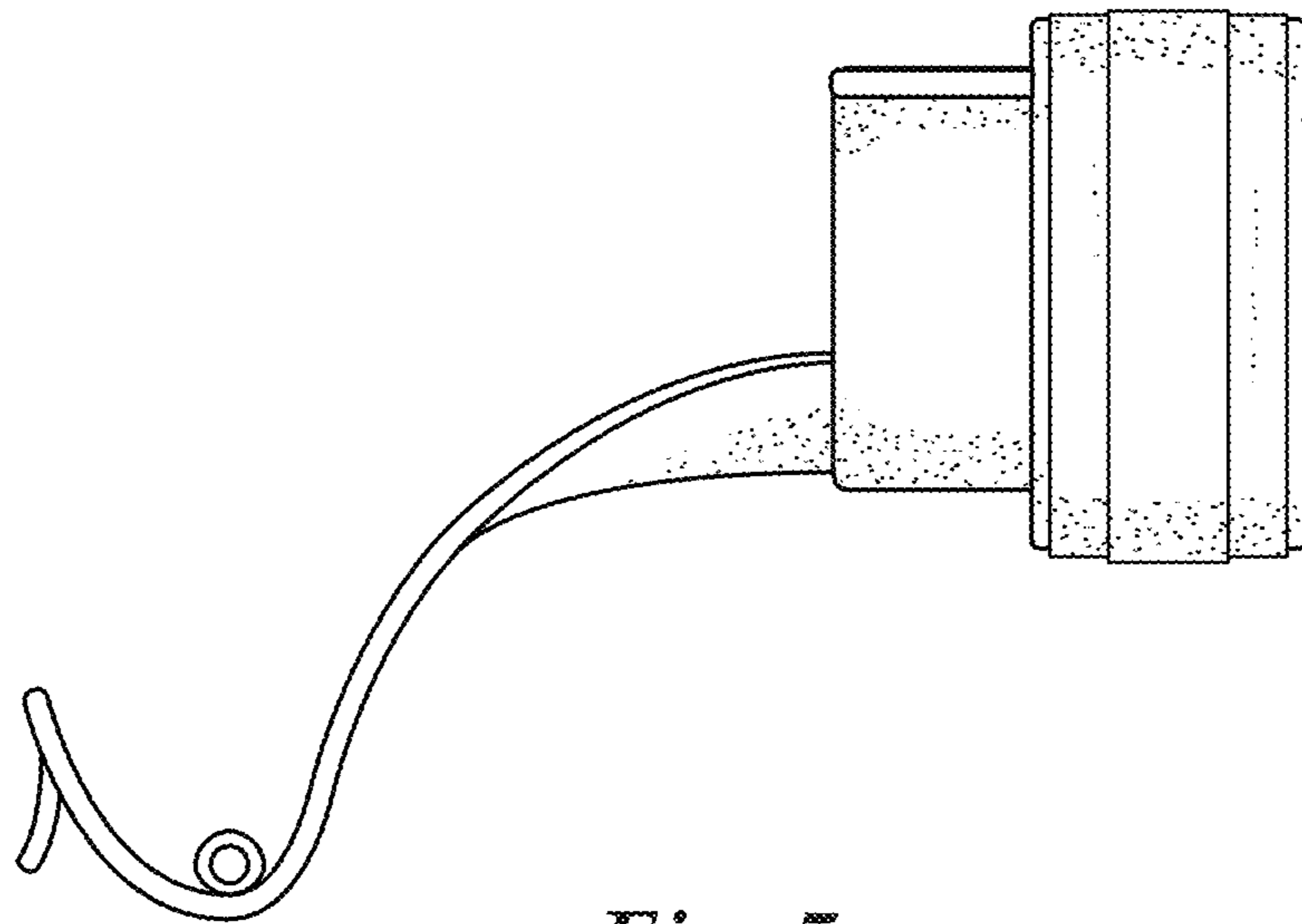

Fig. 5

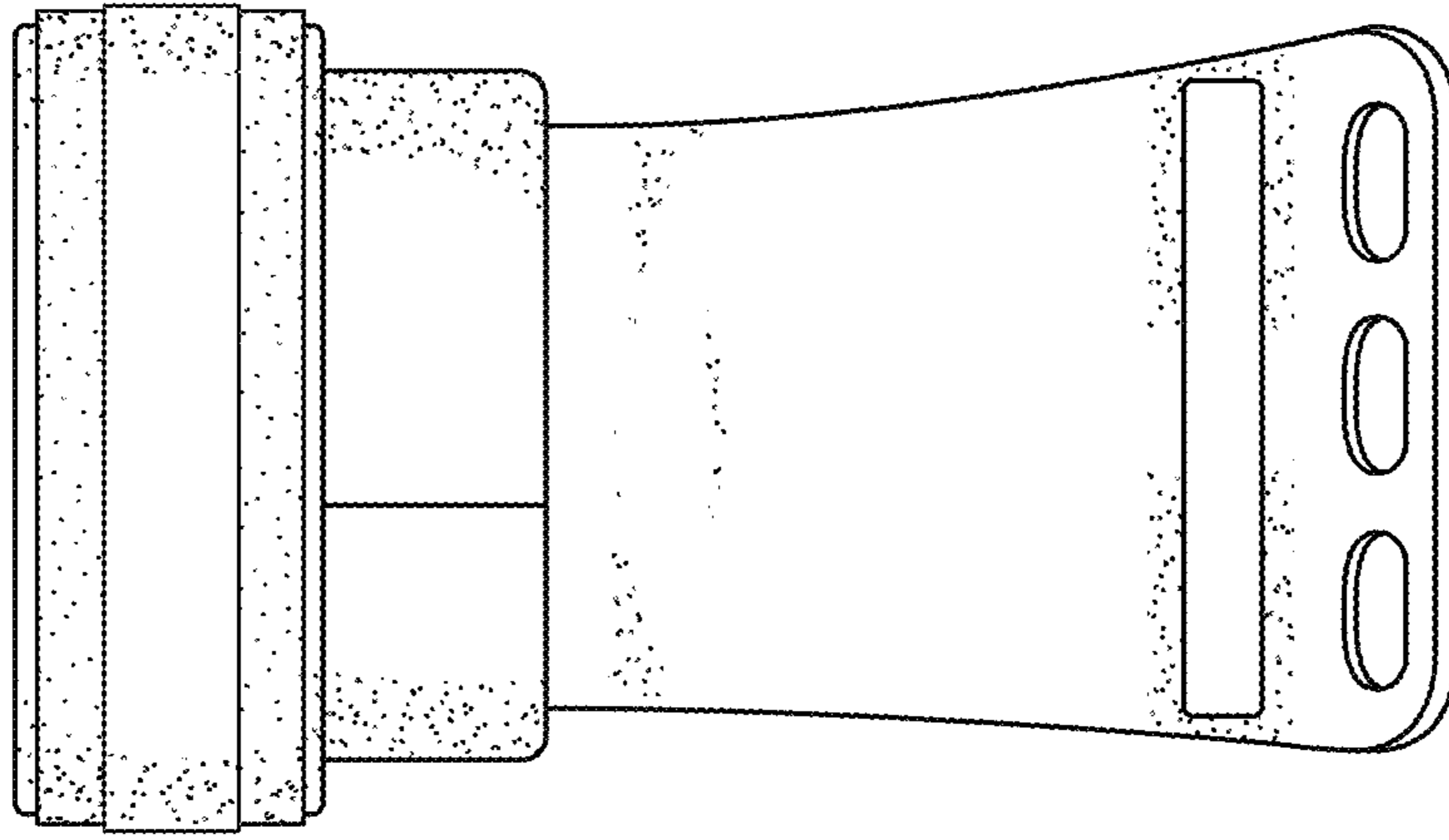

Fig. 6

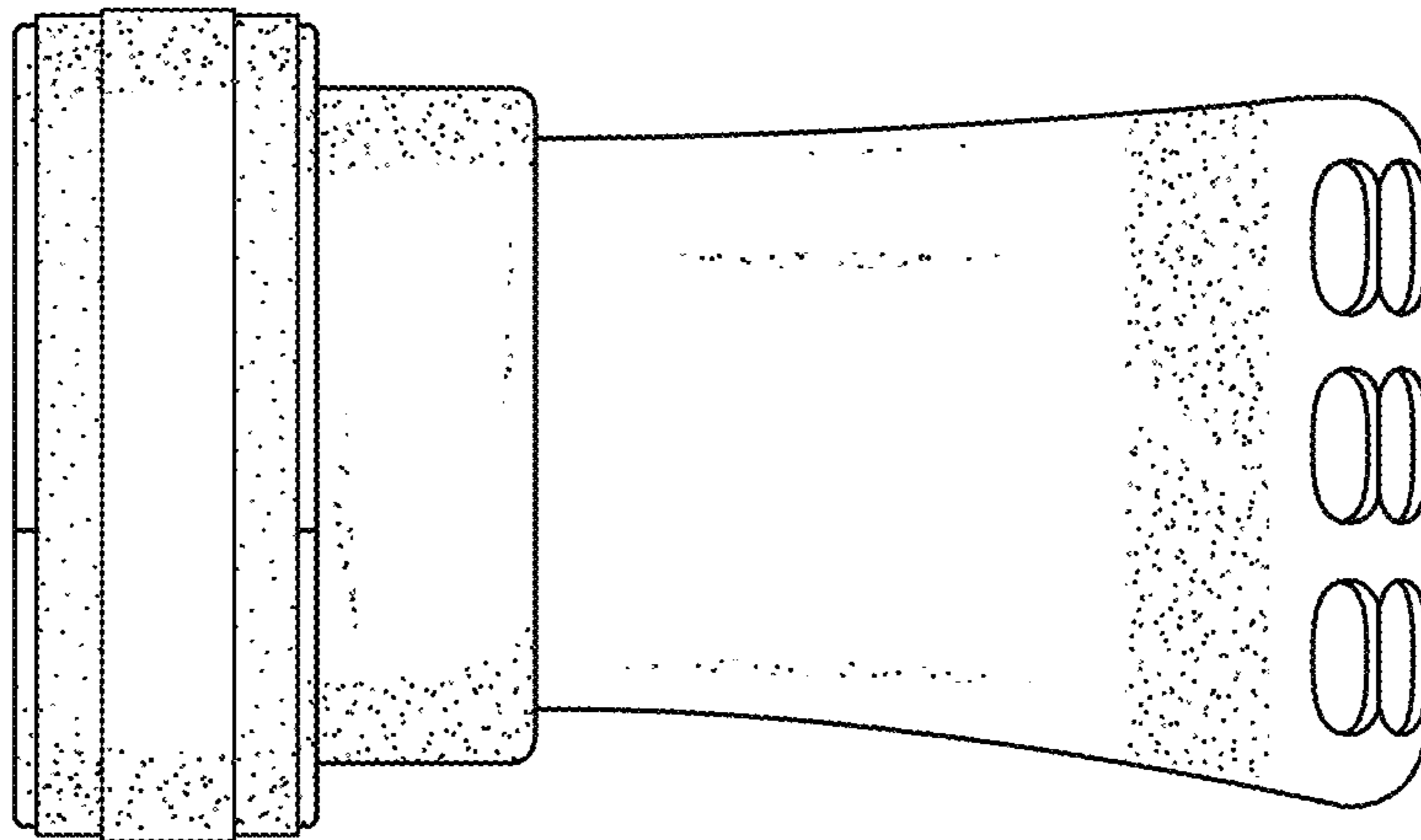

Fig. 7