



US00D741828S

(12) **United States Design Patent**  
**Shin et al.**

(10) **Patent No.:** **US D741,828 S**  
(45) **Date of Patent:** **\*\* Oct. 27, 2015**

- (54) **TELEVISION RECEIVER**
- (71) Applicant: **Samsung Electronics Co., Ltd.**,  
Suwon-si, Gyeonggi-do (KR)
- (72) Inventors: **Rina Shin**, Seoul (KR); **Hyung-Ho Hwangbo**, Seoul (KR); **Hae-Sung Park**, Seoul (KR); **Christopher Edward Bangle**, Clavesana (IT)
- (73) Assignee: **SAMSUNG ELECTRONICS CO., LTD.** (KR)
- (\*\*) Term: **14 Years**
- (21) Appl. No.: **29/472,299**
- (22) Filed: **Nov. 11, 2013**
- (30) **Foreign Application Priority Data**  
May 11, 2013 (KR) ..... 30-2013-0024875
- (51) **LOC (10) Cl.** ..... **14-03**
- (52) **U.S. Cl.**  
USPC ..... **D14/126**
- (58) **Field of Classification Search**  
USPC ..... D14/371-382, 125-134, 239, 448-452, D14/136, 341, 479, 389, 397, 308, 412, 157, D14/155, 511, 432, 498, 138 AD, 336, 337, D14/447; 361/679.02; 348/836, 838, 180, 348/184, 325, 739; 248/917-924, 465; 345/104; D6/300, 301, 302, 308, D6/310-314; D21/392; D18/18; D19/113  
CPC ..... G01F 1/1601  
See application file for complete search history.

D525,607 S *	7/2006	Chia	.....	D14/126
D592,625 S *	5/2009	Hwang	.....	D14/130
D598,444 S *	8/2009	Xie et al.	.....	D14/336
D655,684 S *	3/2012	Kim et al.	.....	D14/126
D662,506 S *	6/2012	Skinner et al.	.....	D14/451
D684,981 S *	6/2013	Chang et al.	.....	D14/451
D699,205 S *	2/2014	Kim et al.	.....	D14/126
D709,470 S *	7/2014	Ryu et al.	.....	D14/126
D714,749 S *	10/2014	Park et al.	.....	D14/126
8,950,725 B2 *	2/2015	Huang et al.	.....	248/917
D725,619 S *	3/2015	Choi	.....	D14/126

\* cited by examiner

*Primary Examiner* — Susan Bennett Hattan  
*Assistant Examiner* — Brett Miller  
(74) *Attorney, Agent, or Firm* — Cantor Colburn LLP

(57) **CLAIM**  
The ornamental design for a television receiver, as shown and described.

**DESCRIPTION**

FIG. 1 is a perspective view of a television receiver, showing our new design;  
FIG. 2 is a front view thereof;  
FIG. 3 is a rear view thereof;  
FIG. 4 is a side view thereof;  
FIG. 5 is another side view thereof;  
FIG. 6 is a top plan view thereof;  
FIG. 7 is a bottom plan view thereof;  
FIG. 8 is a rear perspective view thereof; and,  
FIG. 9 is an enlarged cross section view in FIG. 4.  
The broken lines are for environmental purpose only and form no part of the claimed design.  
The shade lines in the figures show contour and not surface ornamentation.

- (56) **References Cited**  
U.S. PATENT DOCUMENTS  
D491,943 S \* 6/2004 Whitehorn et al. .... D14/375

**1 Claim, 7 Drawing Sheets**

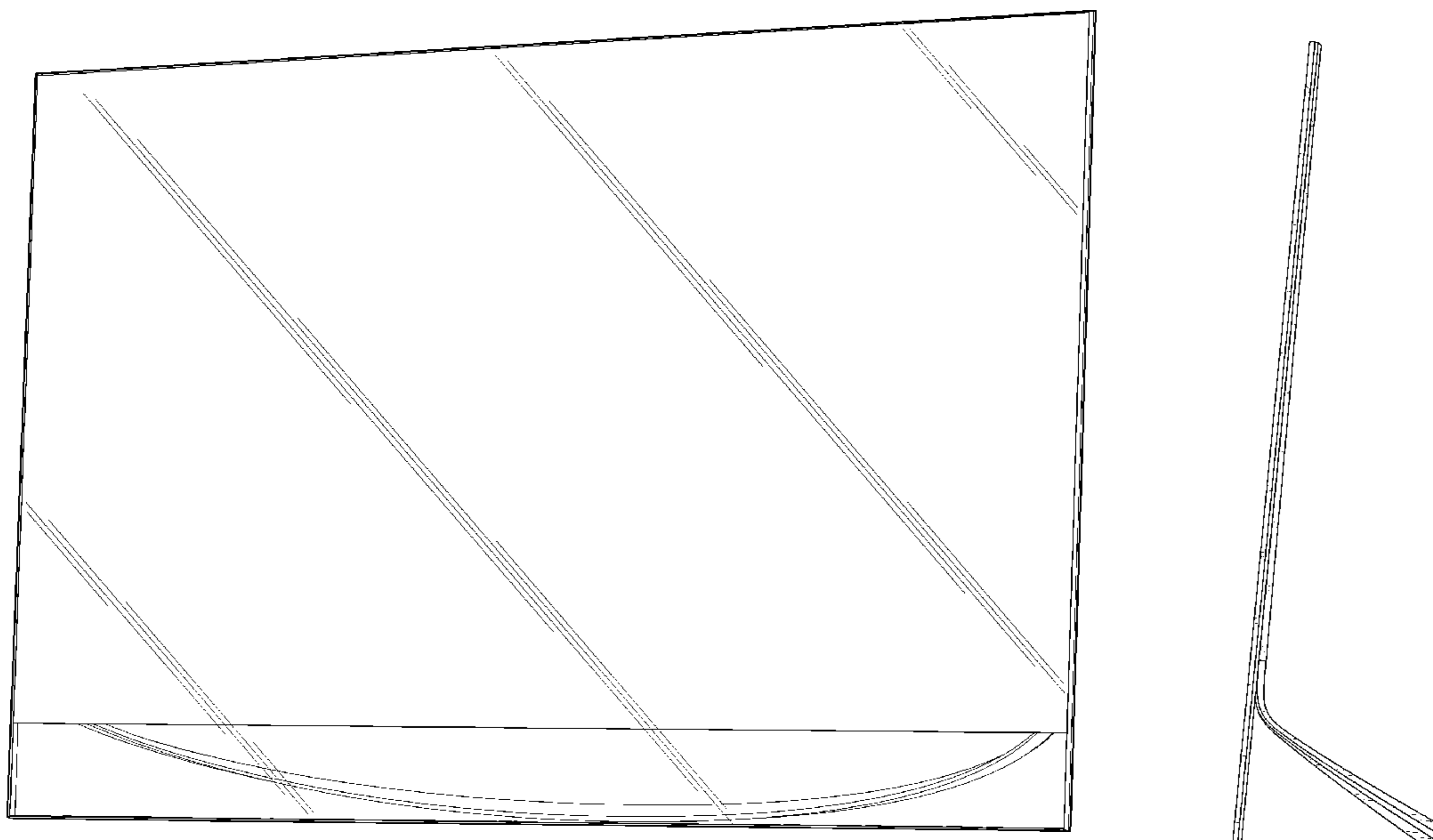

FIG. 1

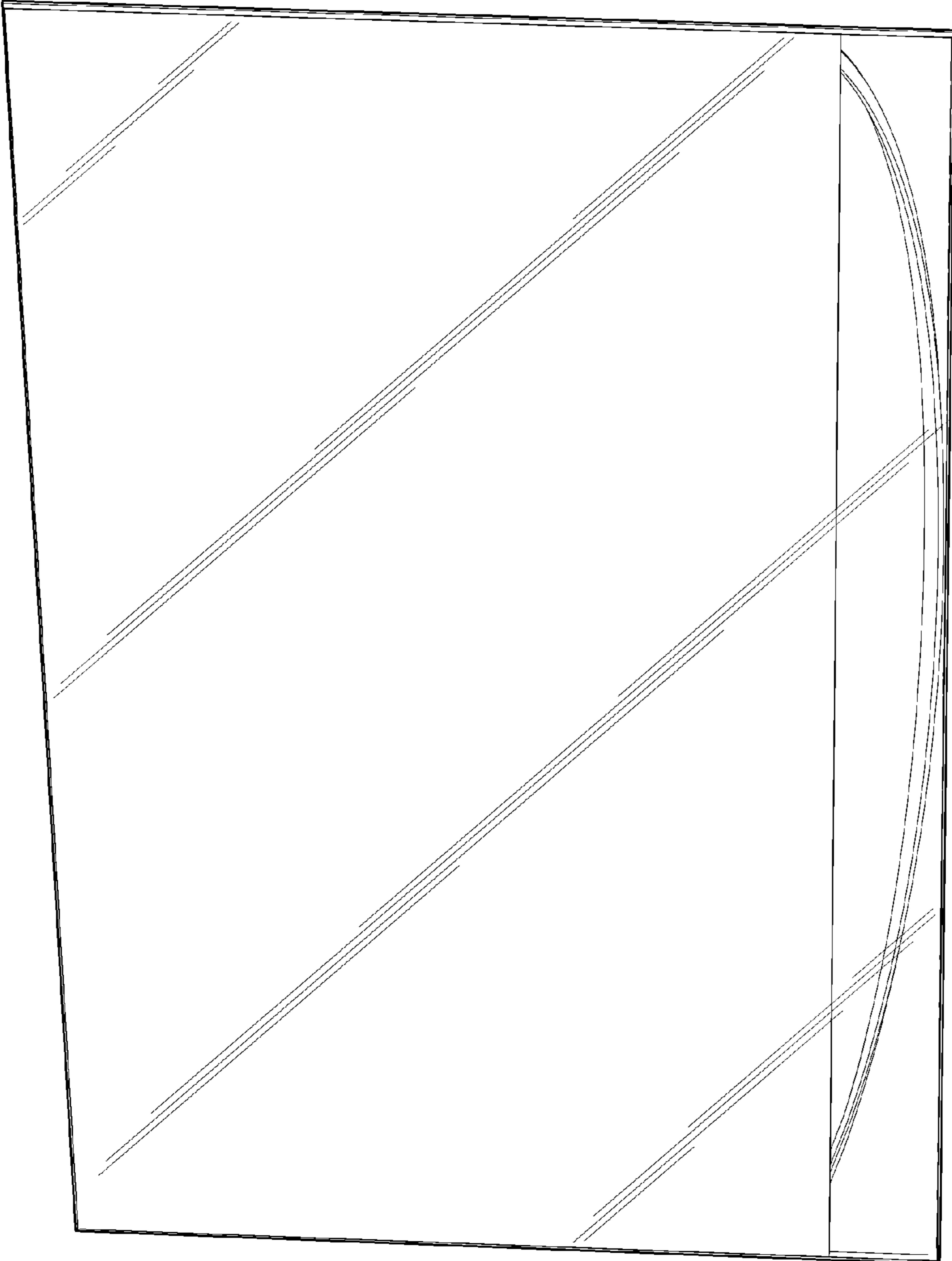

FIG. 2

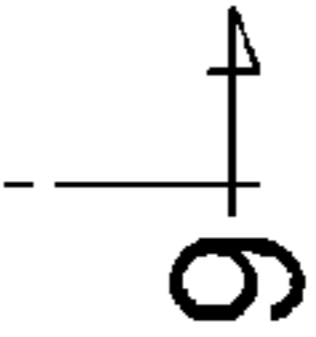
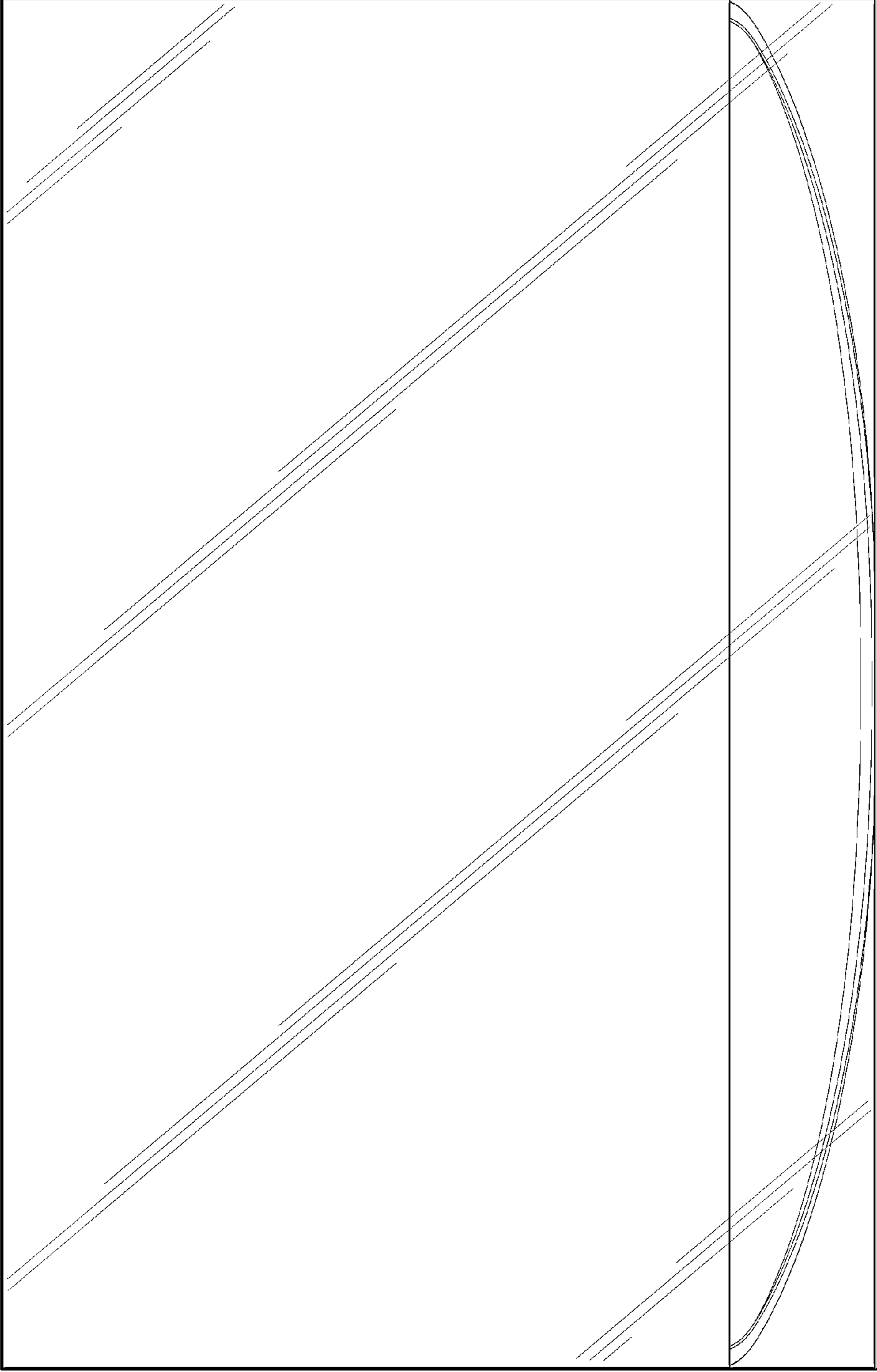
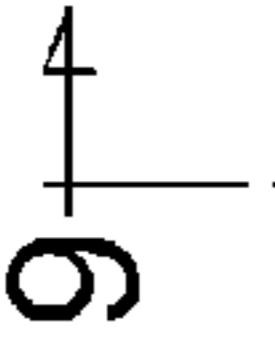

FIG. 3

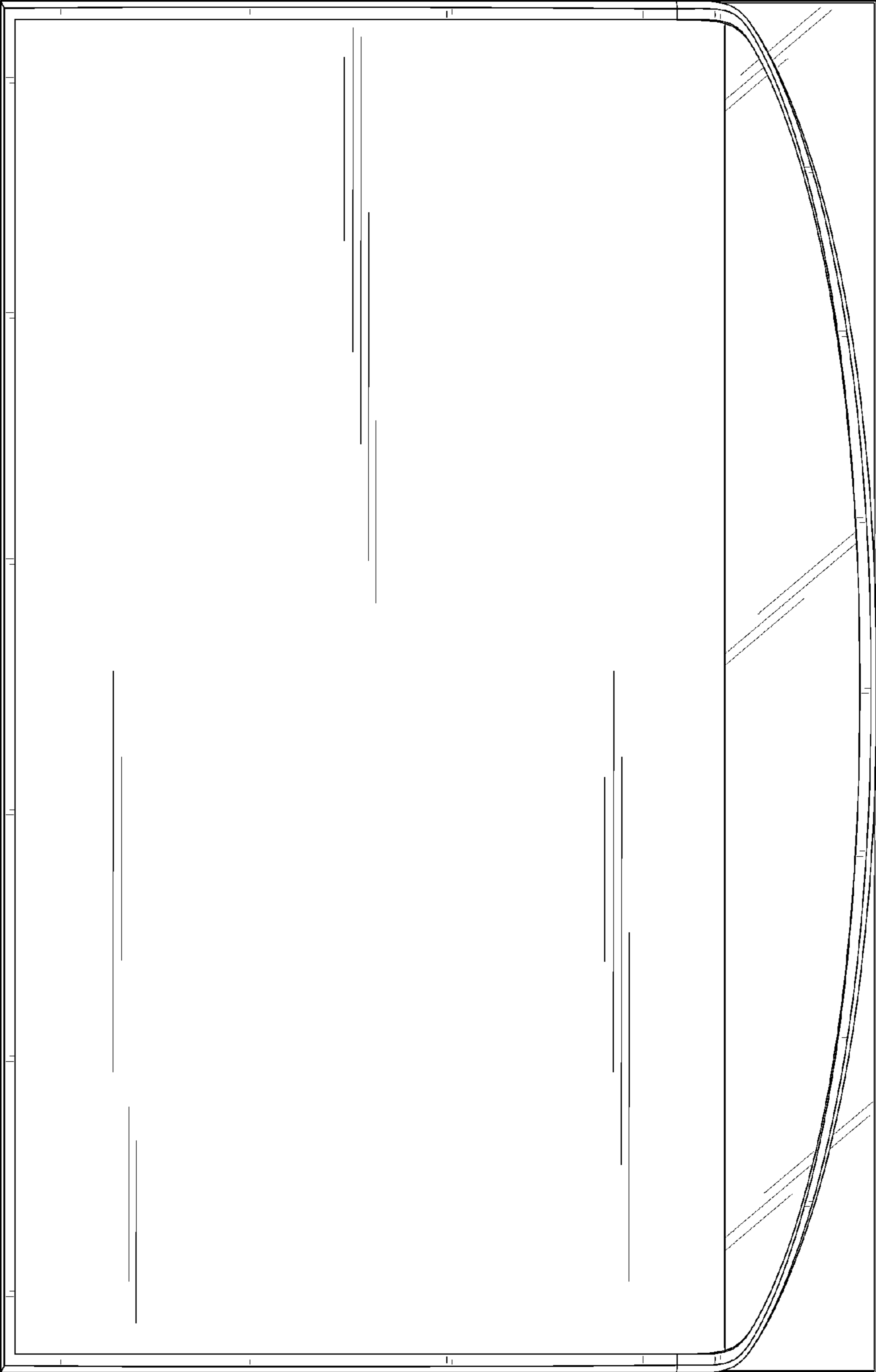

FIG. 5



FIG. 4

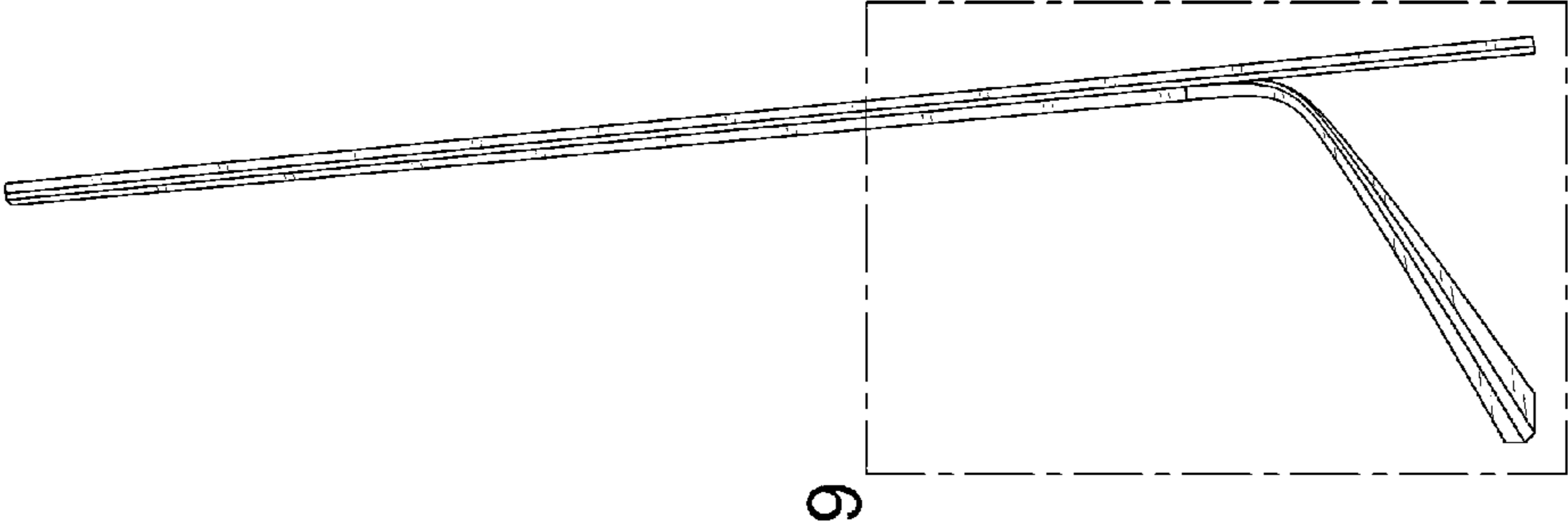

FIG. 6

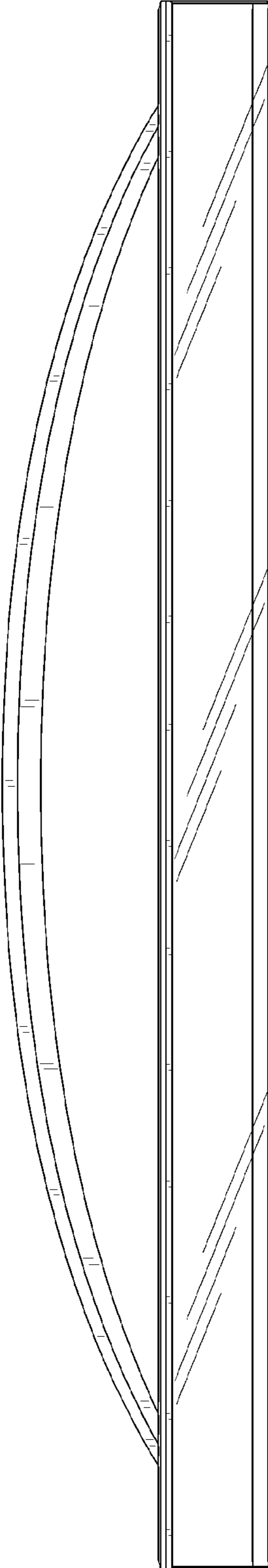

FIG. 7

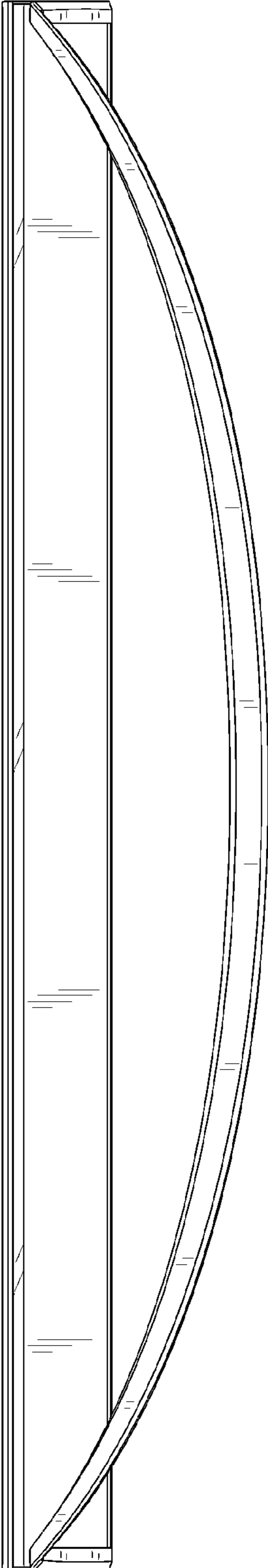

FIG. 8

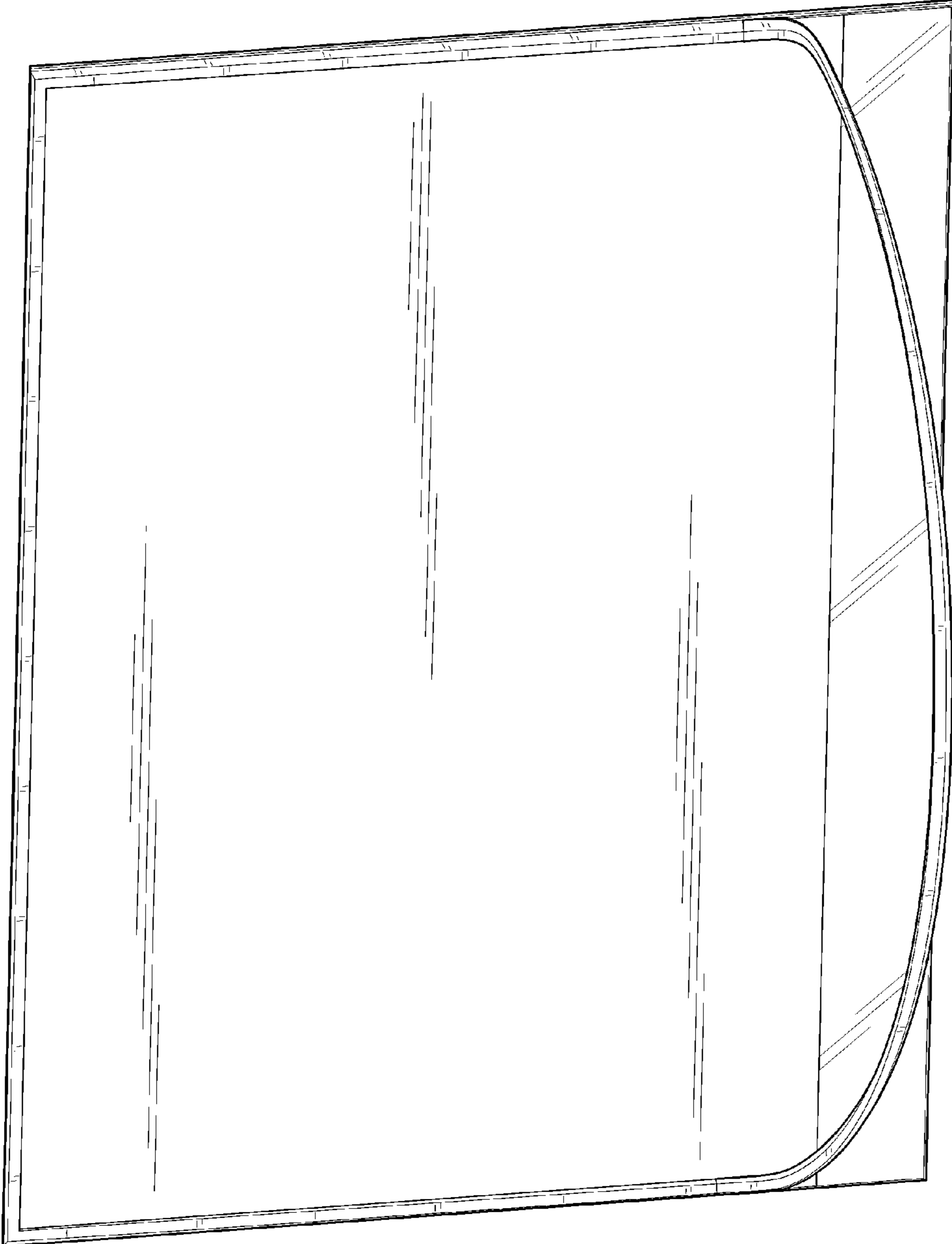

FIG. 9

