



US00D741797S

(12) **United States Design Patent**
Liu

(10) **Patent No.:** **US D741,797 S**

(45) **Date of Patent:** **** Oct. 27, 2015**

(54) **CHARGER**

(71) Applicant: **Qiuming Liu**, Guangdong (CN)

(72) Inventor: **Qiuming Liu**, Guangdong (CN)

(**) Term: **14 Years**

(21) Appl. No.: **29/500,417**

(22) Filed: **Aug. 25, 2014**

(30) **Foreign Application Priority Data**

Mar. 3, 2014 (CN) 2014 3 0039515

(51) **LOC (10) CL.** **13-02**

(52) **U.S. Cl.**
USPC **D13/108**

(58) **Field of Classification Search**
USPC D13/107–110, 118–119, 182, 199;
D14/251, 253, 432, 434; 320/107–115;
D27/172, 193, 194
CPC Y02E 60/12; Y02T 90/14; Y02T 90/122;
Y02T 90/128; Y02T 90/163; H02J 7/025;
H02J 7/0042; H02J 7/0044; H02J 7/0045;
H02J 7/0003; H01F 38/14; H01R 13/6675;
H01M 2/1022; H01M 2/1055; H01M 10/44;
H01M 10/46; H01M 10/425; B60L 11/182;
A24F 47/008

See application file for complete search history.

(56) **References Cited**

U.S. PATENT DOCUMENTS

D649,932 S * 12/2011 Symons D13/108
D673,110 S * 12/2012 Sasada et al. D13/108
D680,063 S * 4/2013 Sasada D13/103

D686,987 S * 7/2013 Vanstone et al. D13/108
D693,765 S * 11/2013 Workman et al. D13/110
D704,629 S * 5/2014 Liu D13/108
D704,634 S * 5/2014 Eidelman et al. D13/108
D718,233 S * 11/2014 Aumiller et al. D13/108
D718,712 S * 12/2014 Aumiller et al. D13/108
D725,034 S * 3/2015 Chen D13/108
2014/0014124 A1* 1/2014 Glasberg et al. 131/328
2014/0196732 A1* 7/2014 Liu 131/329

* cited by examiner

Primary Examiner — Rosemary K Tarcza

(74) *Attorney, Agent, or Firm* — Locke Lord LLP; Tim Tingkang Xia, Esq.

(57) **CLAIM**

The ornamental design for a charger, as shown and described.

DESCRIPTION

FIG. 1 is a front elevational view of an embodiment of a charger;
FIG. 2 is a rear elevational view of the embodiment of the charger;
FIG. 3 is a left side elevational view of the embodiment of the charger;
FIG. 4 is a right side elevational view of the embodiment of the charger;
FIG. 5 is a top plan view of the embodiment of the charger;
FIG. 6 is a bottom plan view of the embodiment of the charger; and,
FIG. 7 is a perspective view of the embodiment of the charger.
The broken lines shown in the drawings are included for the purpose of illustrating environmental structure and form no part of the claimed design.

1 Claim, 6 Drawing Sheets

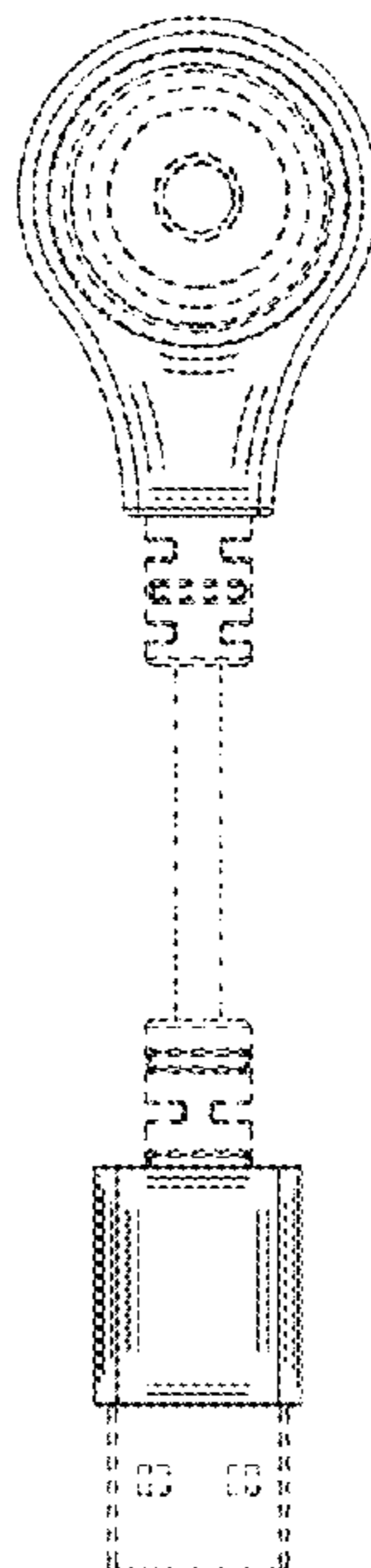

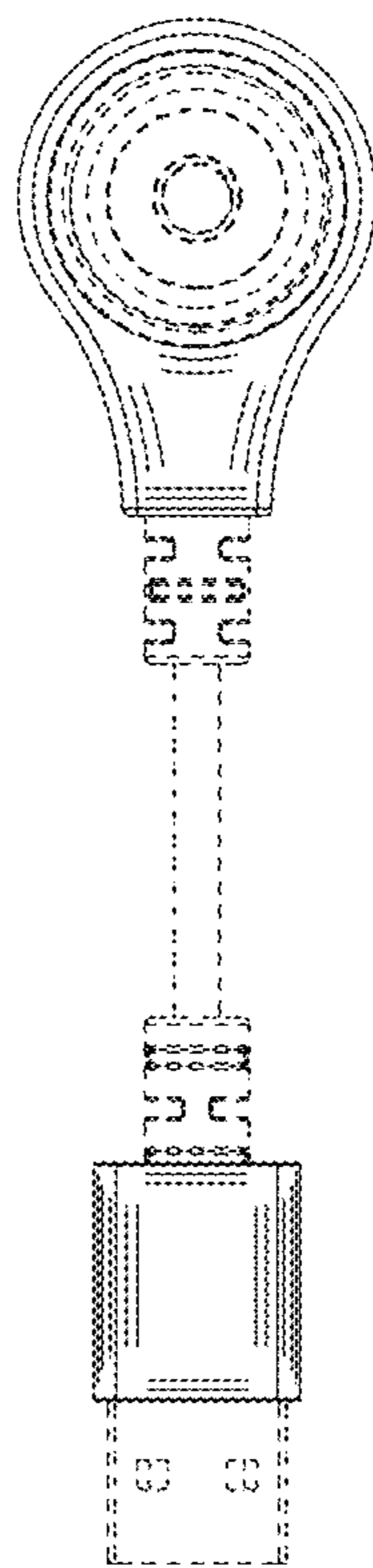

Fig. 1

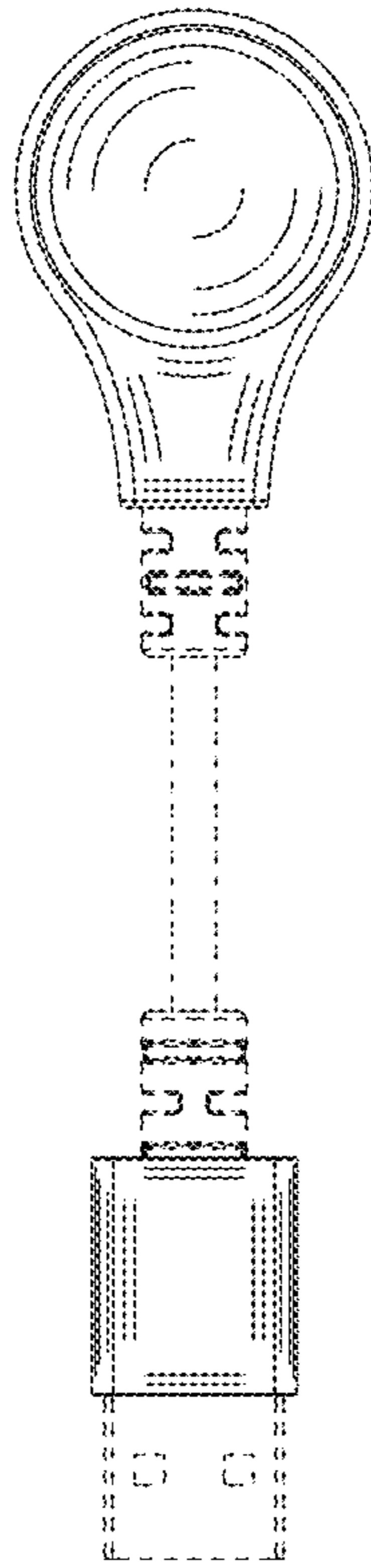

Fig. 2

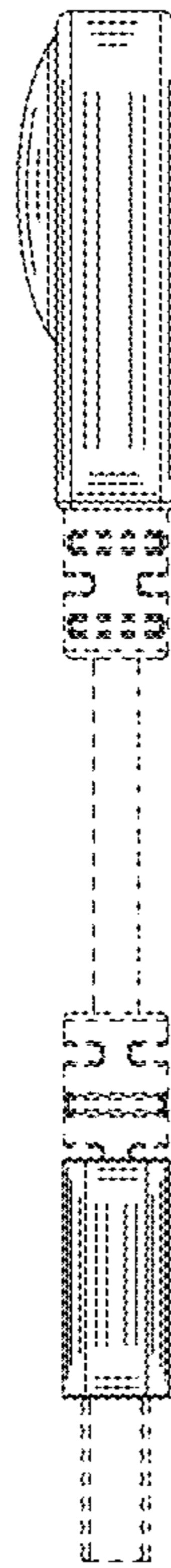

Fig. 3

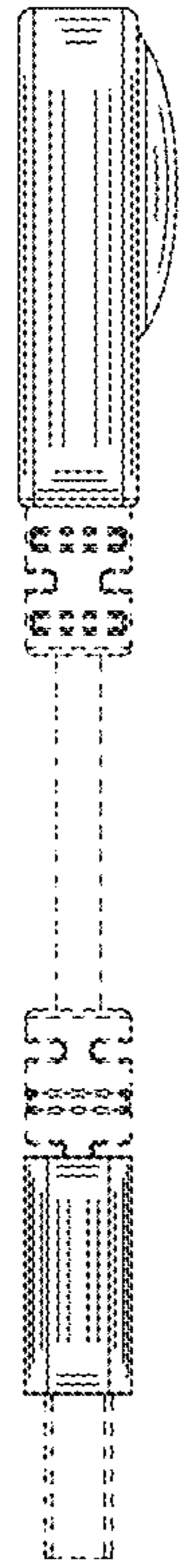

Fig. 4

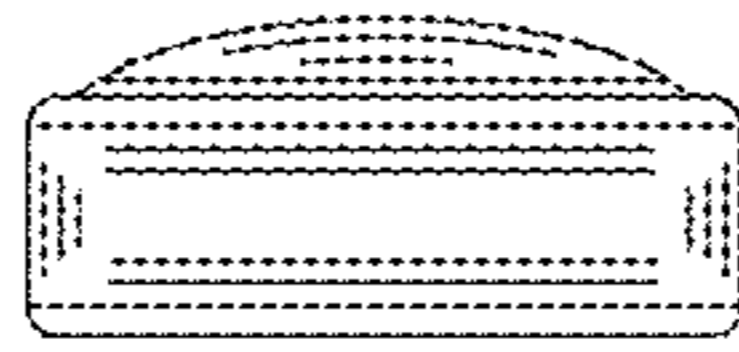

Fig. 5



Fig. 6

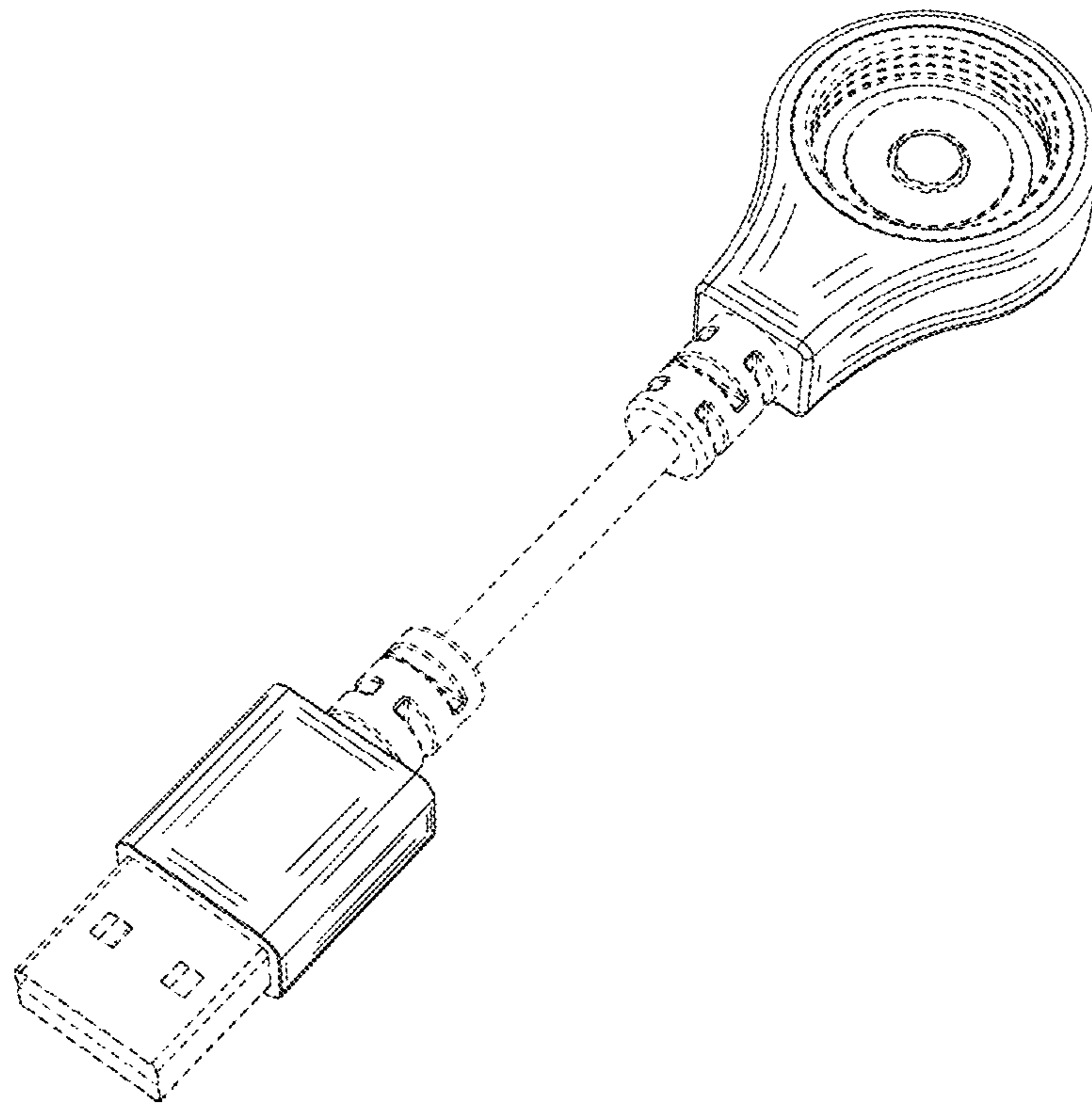

Fig. 7