



US00D741777S

(12) **United States Design Patent**
Henderson

(10) **Patent No.:** **US D741,777 S**

(45) **Date of Patent:** **** Oct. 27, 2015**

(54) **BICYCLE WHEEL SKEWER**

(71) Applicant: **Neal Henderson**, Escondido, CA (US)

(72) Inventor: **Neal Henderson**, Escondido, CA (US)

(**) Term: **14 Years**

(21) Appl. No.: **29/501,514**

(22) Filed: **Sep. 4, 2014**

(51) **LOC (10) Cl.** **12-16**

(52) **U.S. Cl.**

USPC **D12/213**

(58) **Field of Classification Search**

USPC D12/204-213, 400; 301/37.41, 124.1,
301/110.5; 297/380; D8/14

CPC B60B 27/02; B62H 5/00; B62K 25/02;
B62K 2206/00

See application file for complete search history.

(56) **References Cited**

U.S. PATENT DOCUMENTS

D34,971	S *	8/1901	Rictor	D12/213
D35,244	S *	10/1901	Jackson	D12/213
5,984,423	A	11/1999	Becker		
6,588,852	B2 *	7/2003	Mason	301/37.41
7,140,694	B2 *	11/2006	Mason	301/37.41
7,267,410	B2 *	9/2007	Ito et al.	301/5.21
D565,492	S *	4/2008	Chiang	D12/213
D626,054	S *	10/2010	Walthert	D12/213
8,251,452	B2 *	8/2012	Hill	297/380
2007/0052285	A1	3/2007	Montague		
2011/0139840	A1	6/2011	Kraeuter		

* cited by examiner

Primary Examiner — Stacia Cadmus

(74) *Attorney, Agent, or Firm* — Mark Wisnosky

(57) **CLAIM**

The ornamental design for a bicycle wheel skewer, as shown and described.

DESCRIPTION

FIG. 1 is a perspective top view of the nut of the invented bicycle wheel skewer.

FIG. 2 is a perspective bottom view of the nut of FIG. 1.

FIG. 3 is a right side view of the nut of FIG. 1.

FIG. 4 is a left side view of the nut of FIG. 1.

FIG. 5 is a rear view of the nut of FIG. 1.

FIG. 6 is a front view of the nut of FIG. 1.

FIG. 7 is a top view of the nut of FIG. 1.

FIG. 8 is a bottom view of the nut of FIG. 1.

FIG. 9 is a top view of the bolt of the invented bicycle wheel skewer.

FIG. 10 is a bottom view of the bolt of FIG. 9.

FIG. 11 is a front view of the bolt of FIG. 9. The Back View is the same and not shown.

FIG. 12 is a left side view of a bolt of FIG. 9. The right side view is identical and not shown; and,

FIG. 13 is an assembled perspective view of the invented bicycle wheel skewer using the parts [nut and bolt] shown in FIGS. 1-12.

The nut and bolt of the bicycle wheel skewer are shown separately in FIGS. 1-8 and FIGS. 9-12 respectively for ease of illustration.

1 Claim, 6 Drawing Sheets

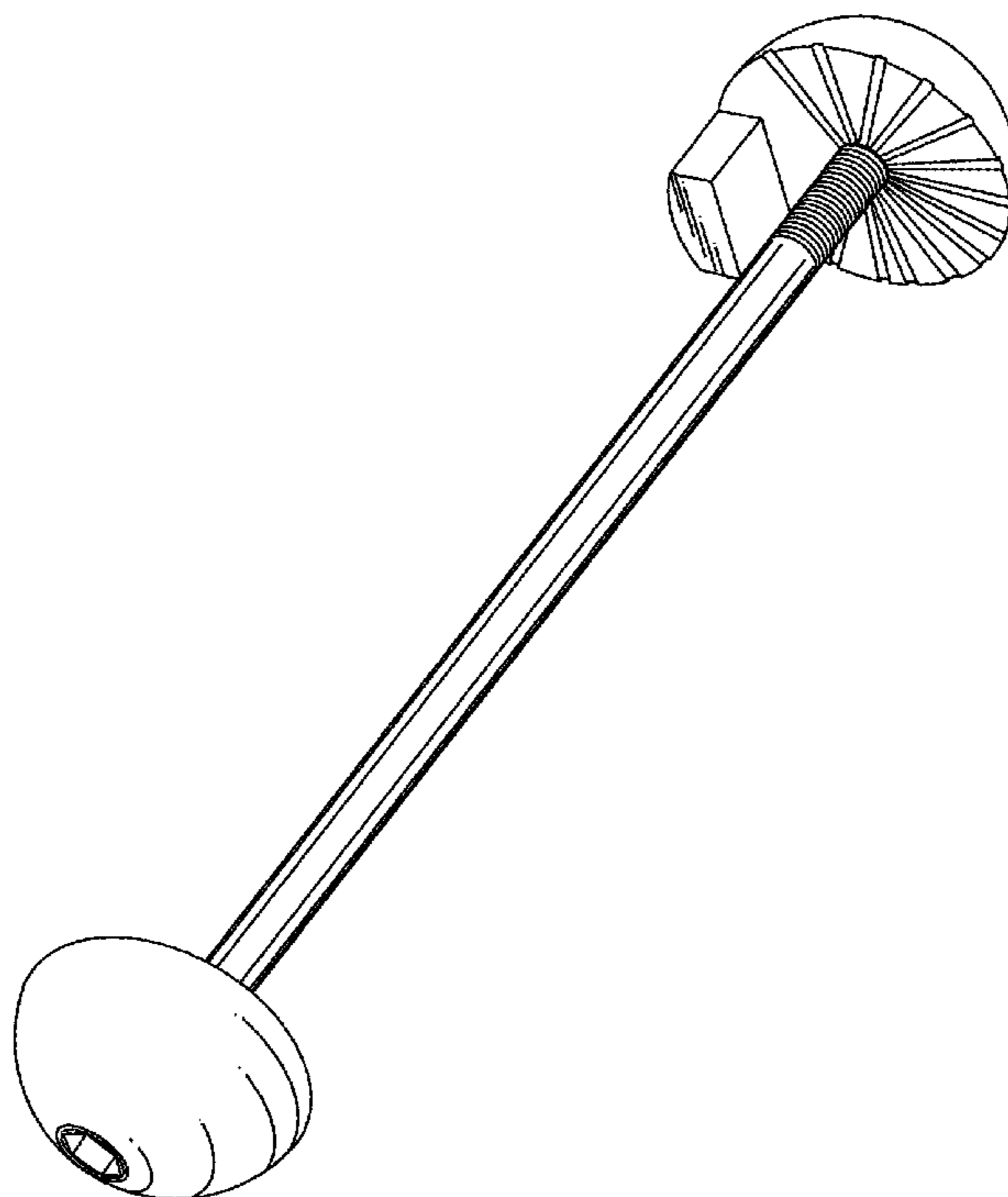

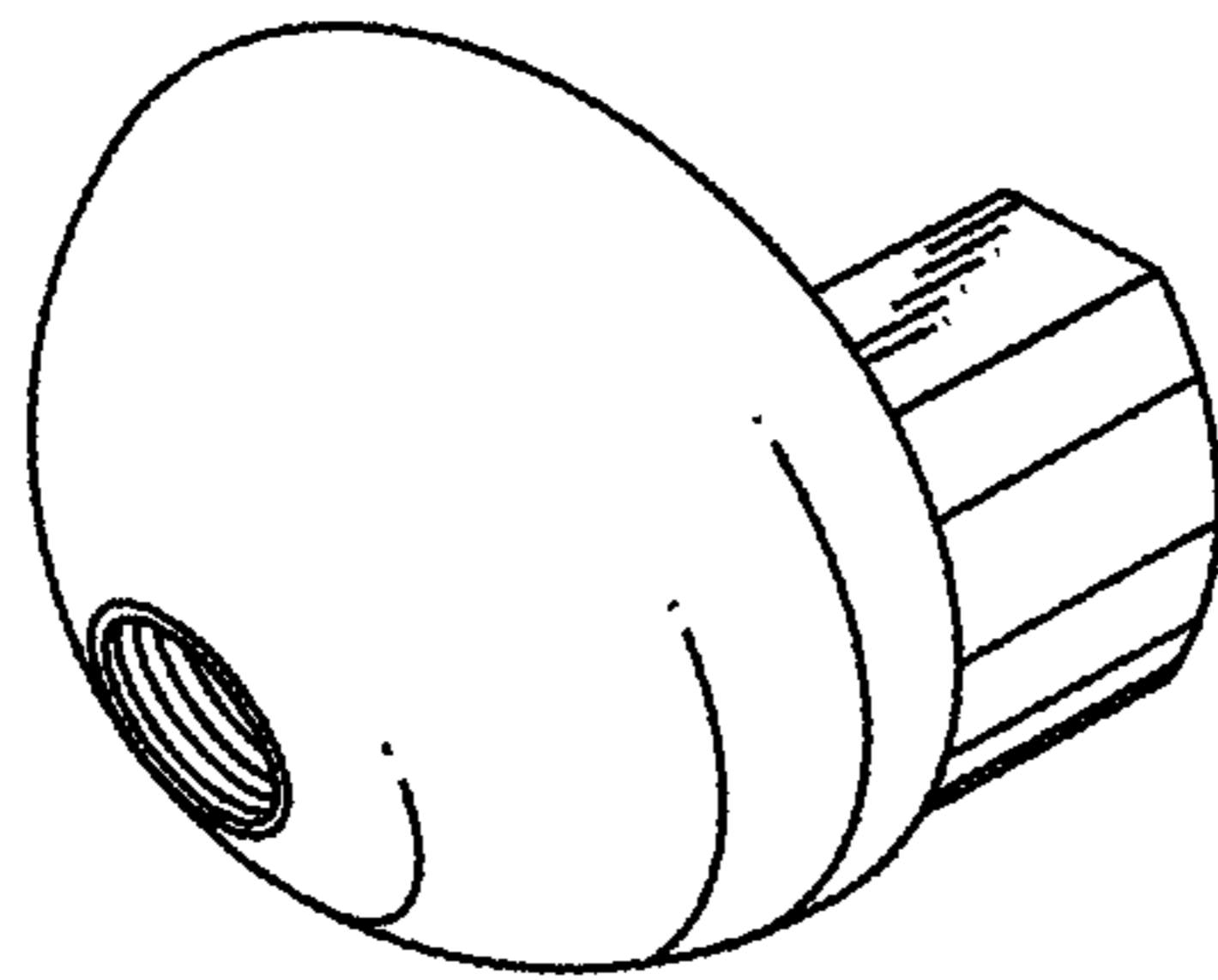

Fig. 1

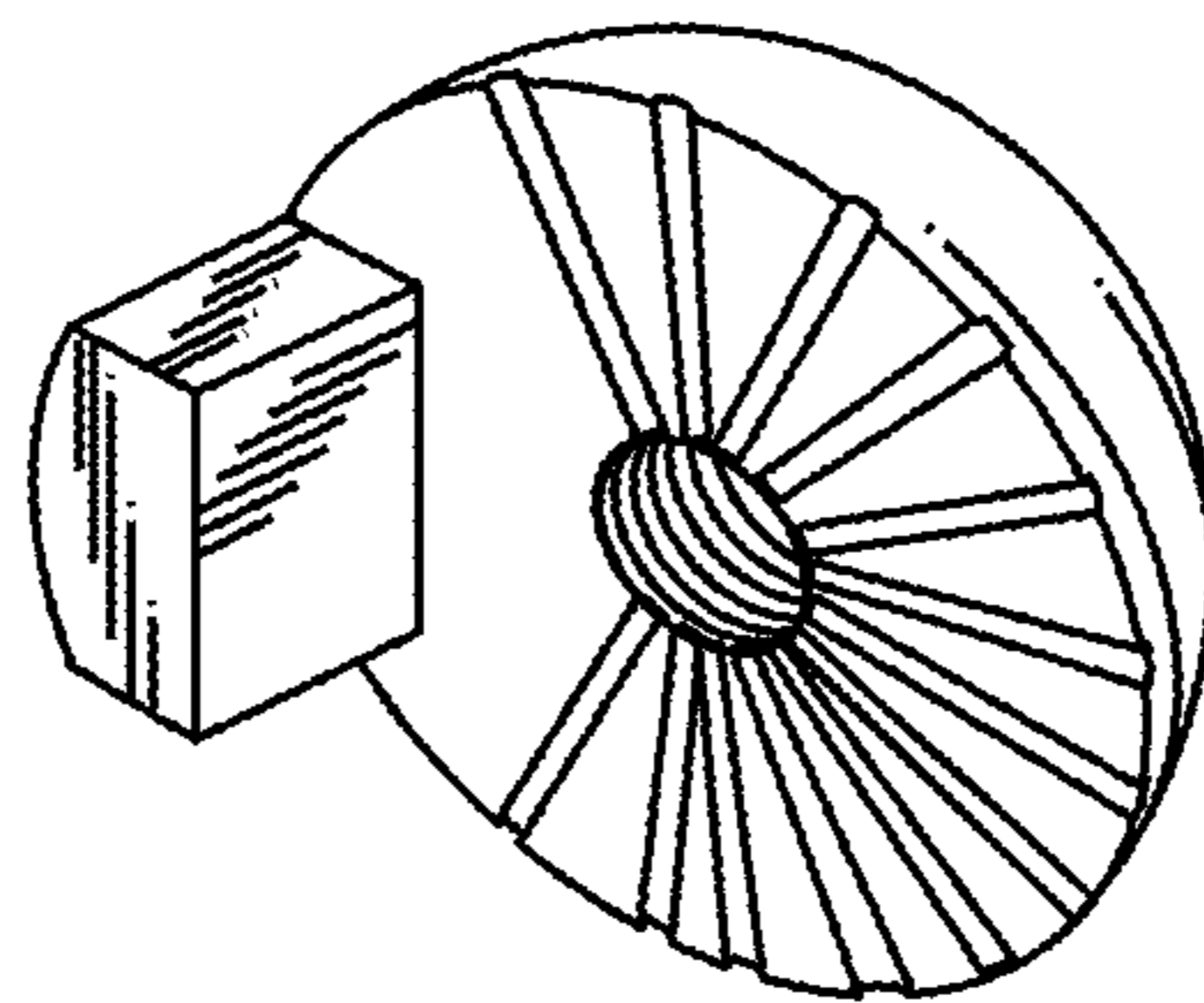

Fig. 2

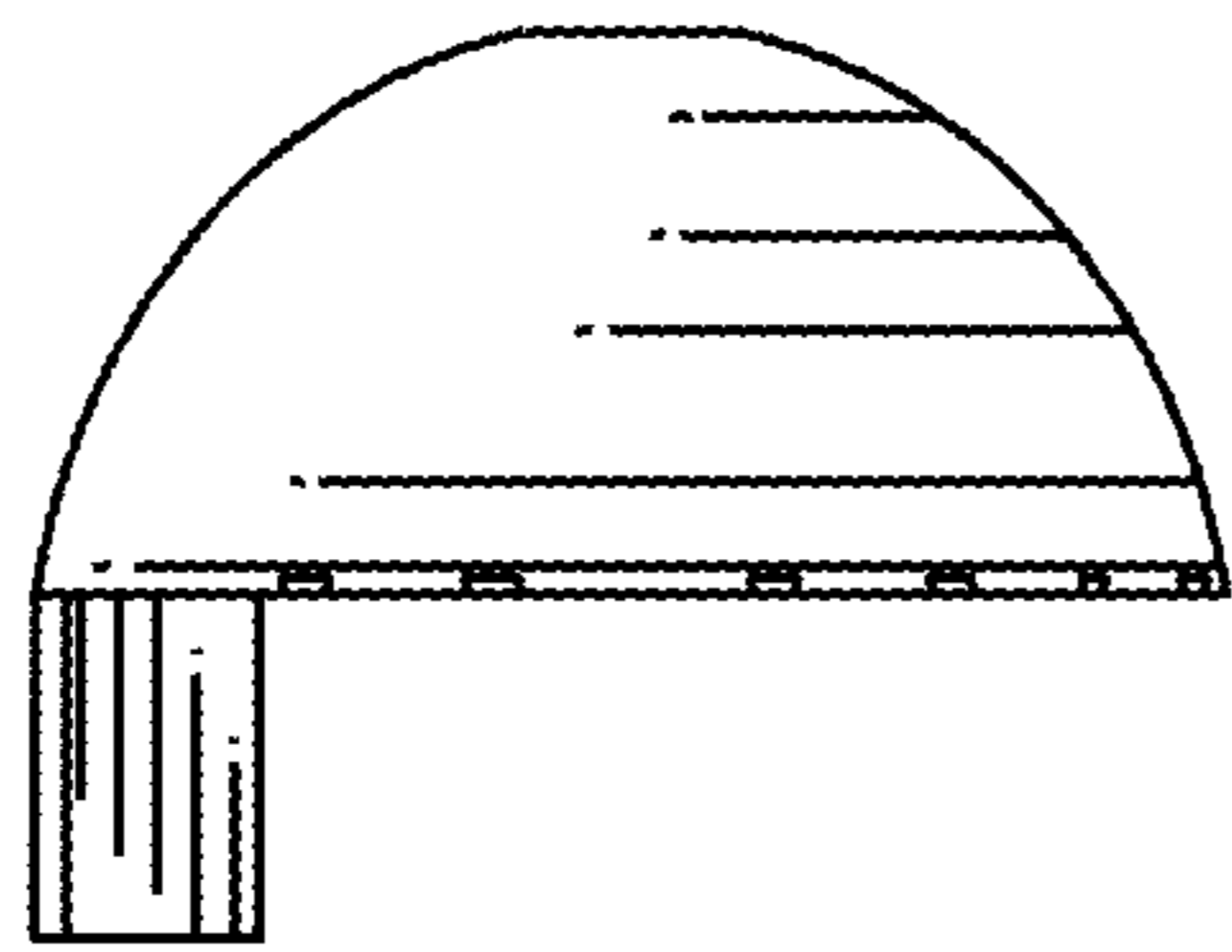

Fig. 3

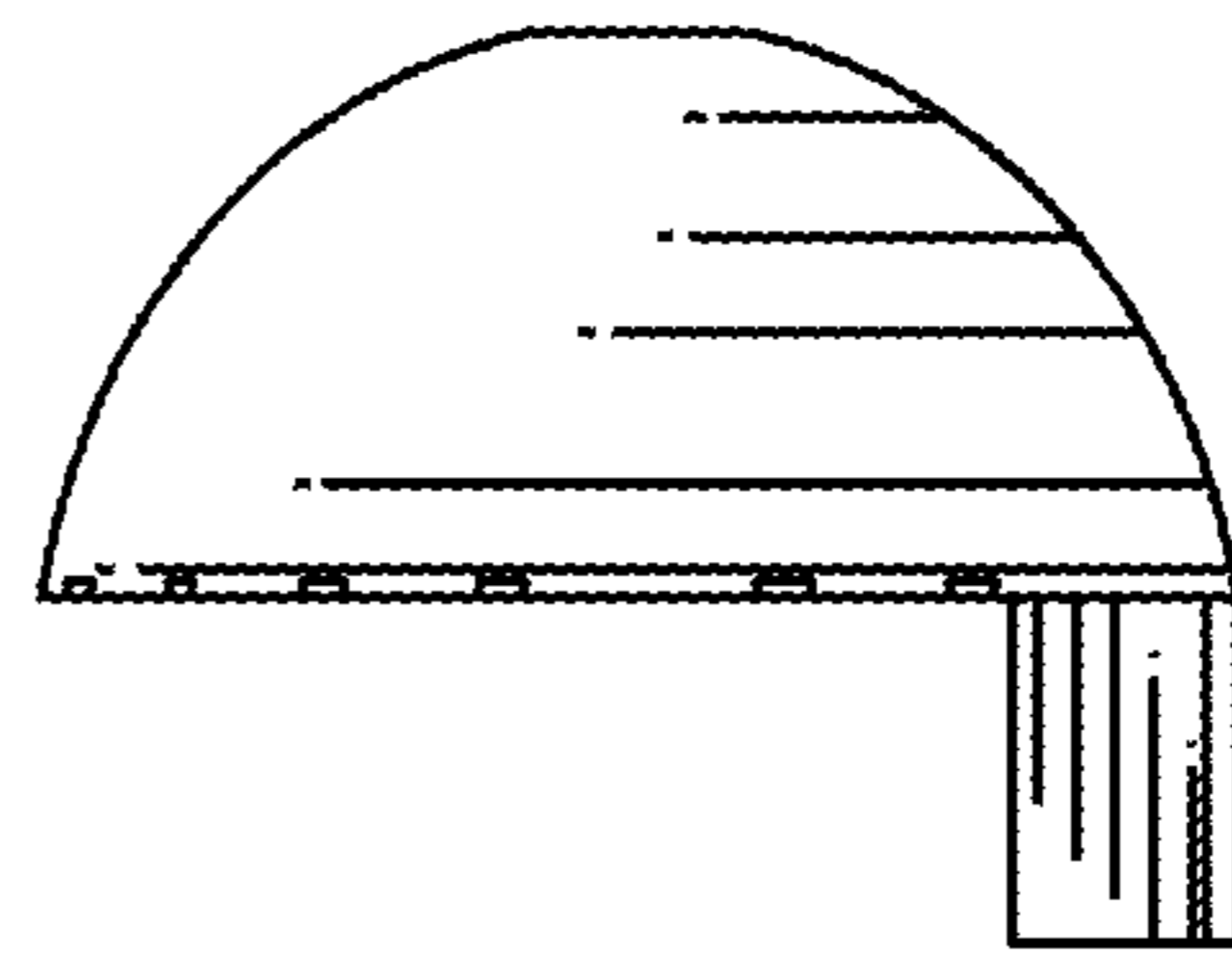

Fig. 4

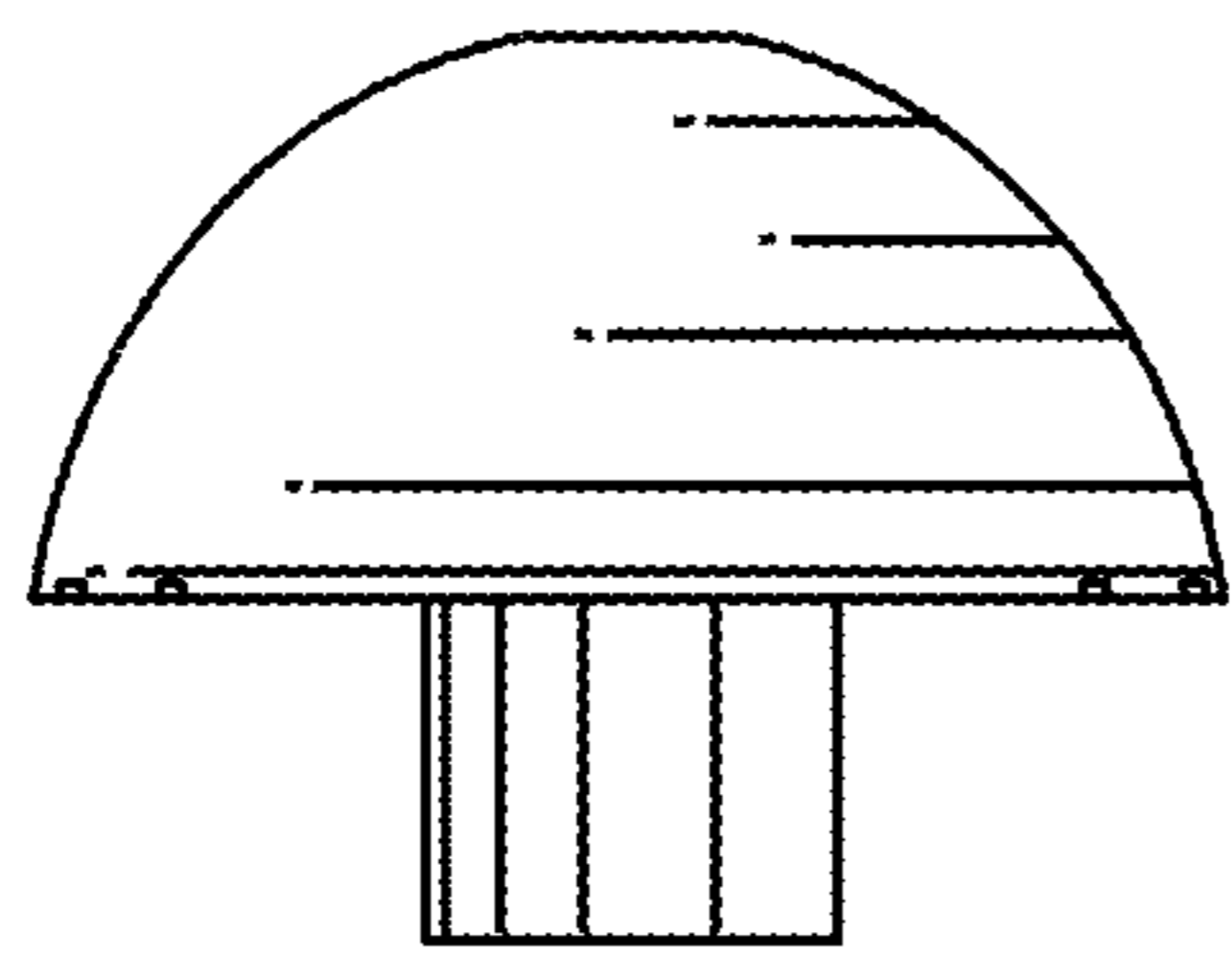

Fig. 5

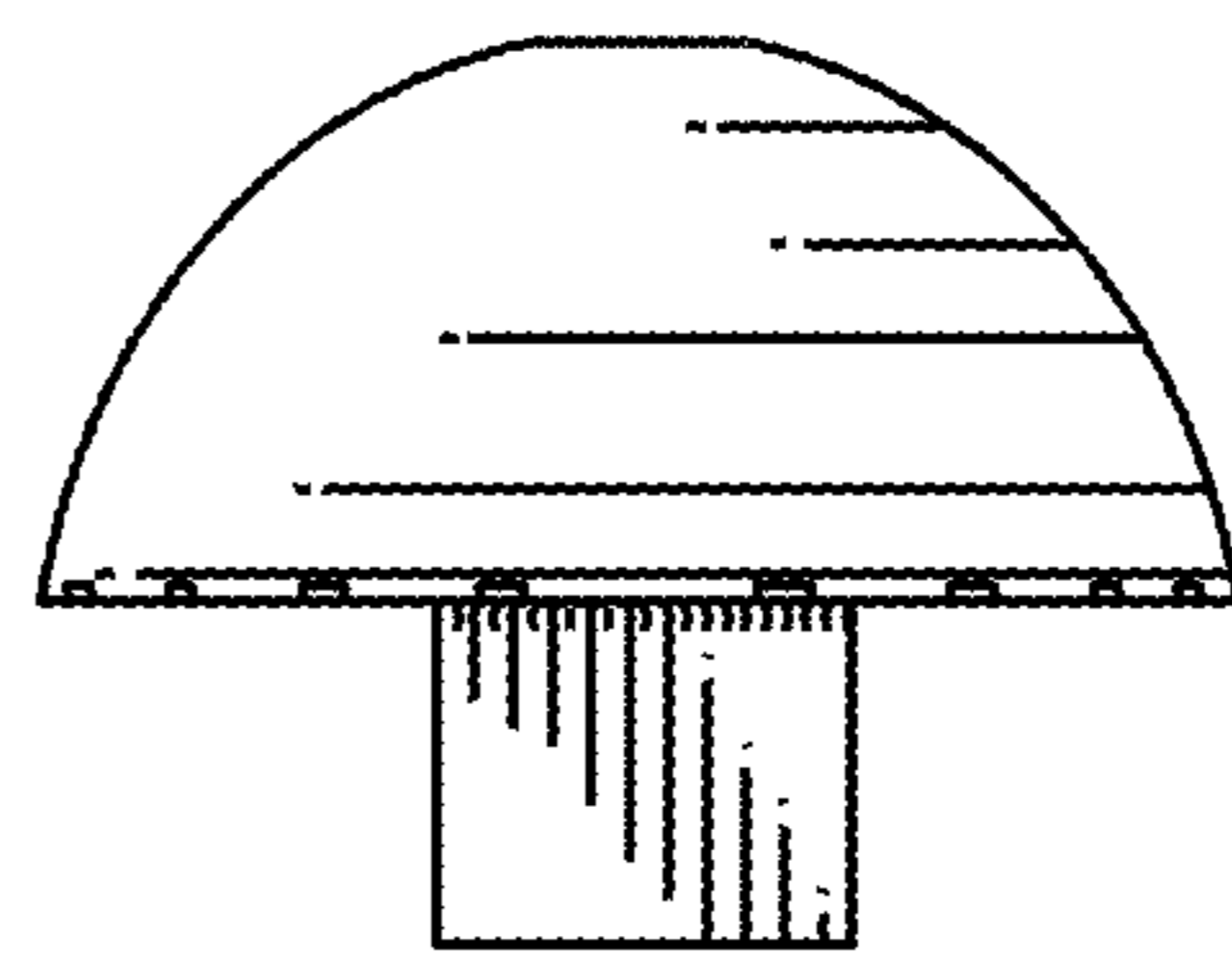

Fig. 6

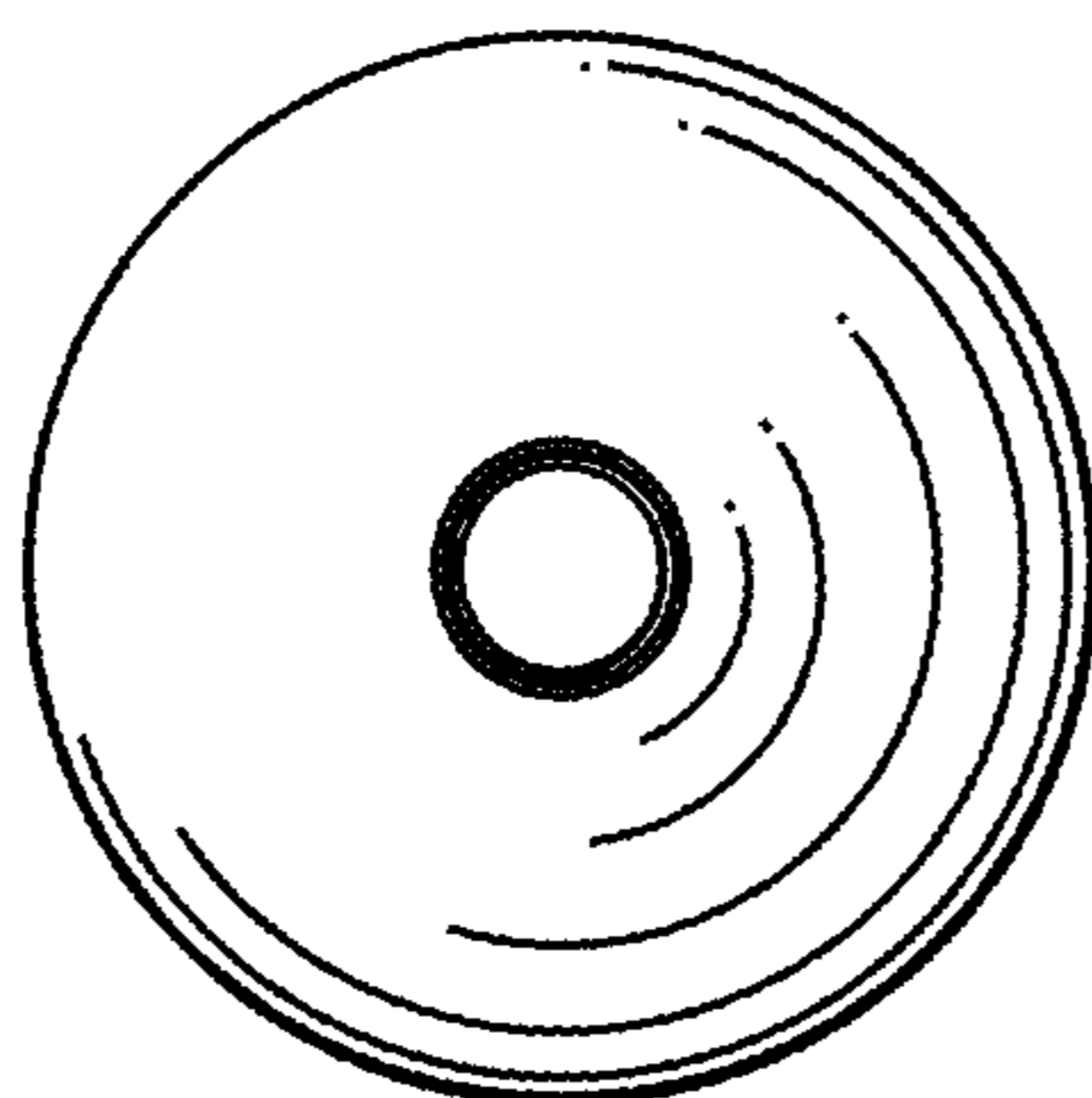

Fig. 7

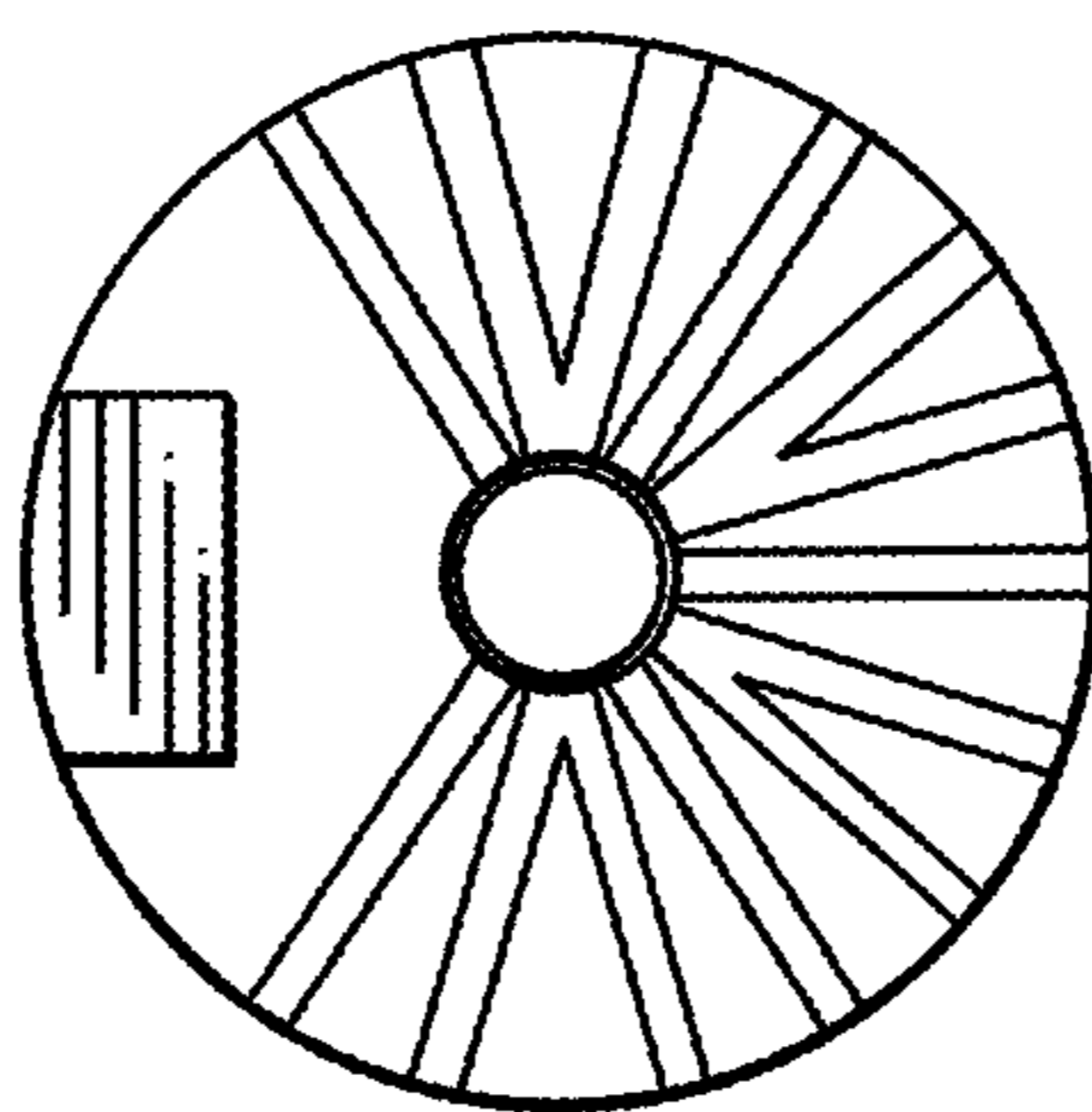

Fig. 8

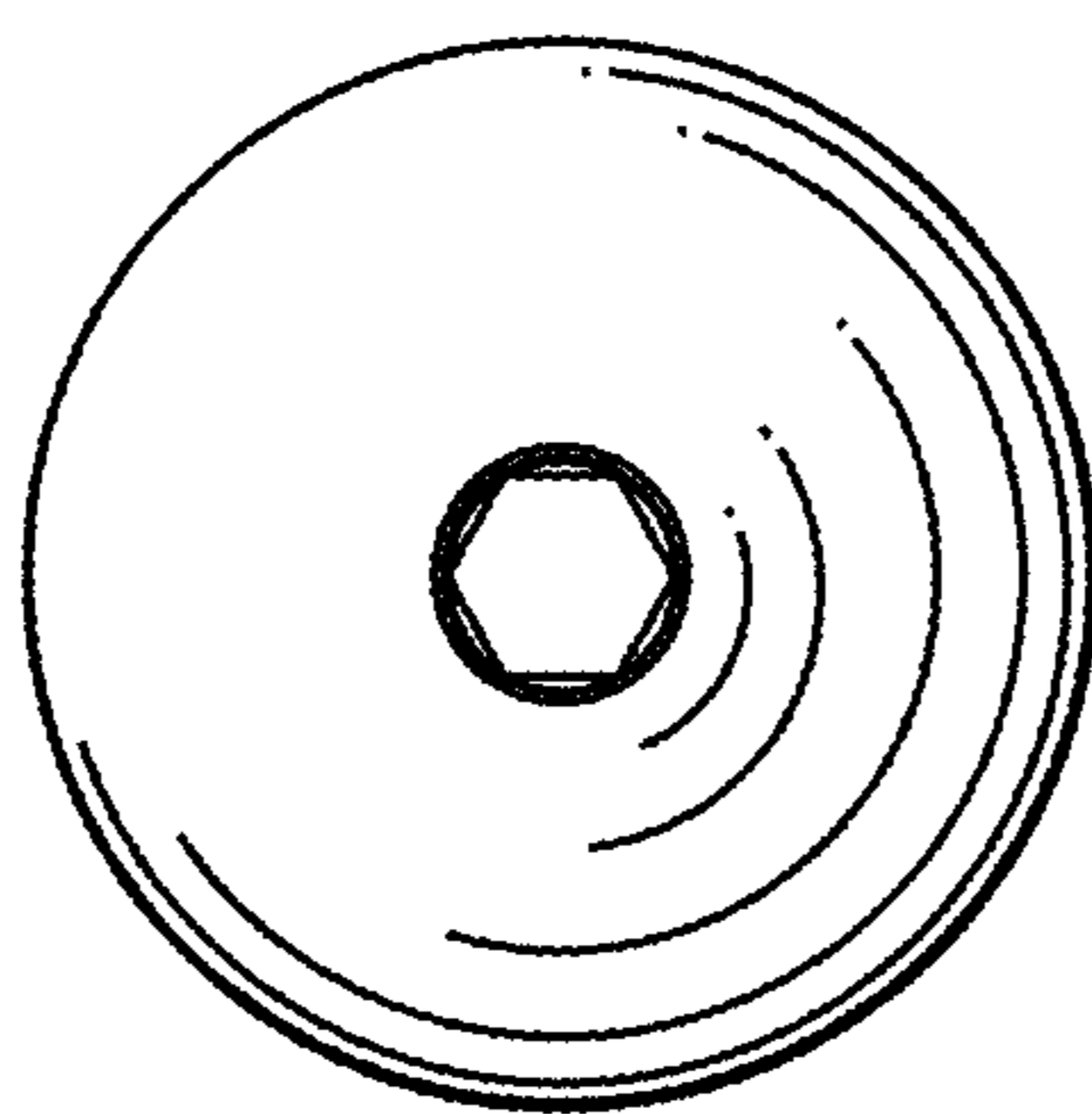

Fig. 9

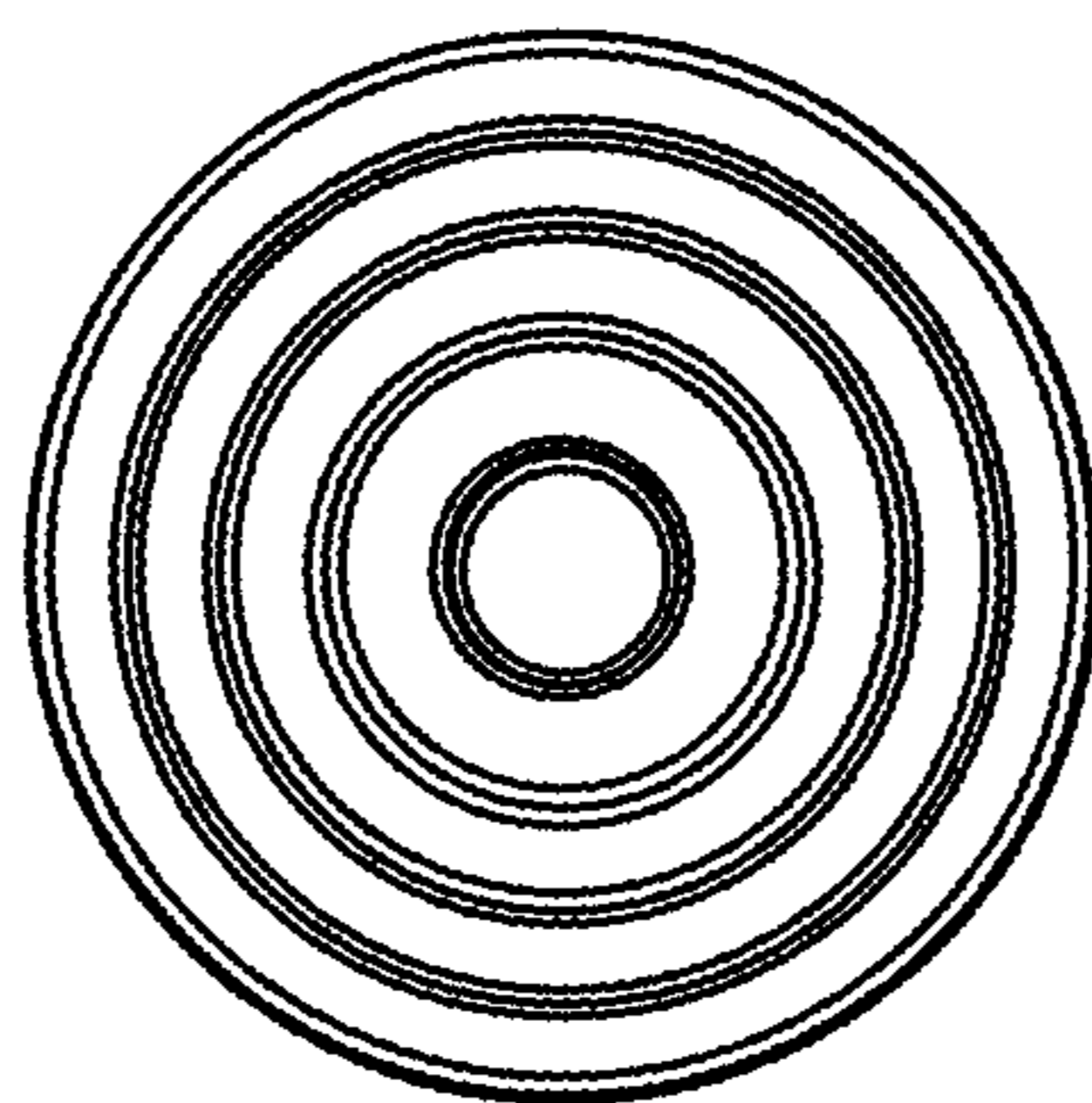

Fig. 10

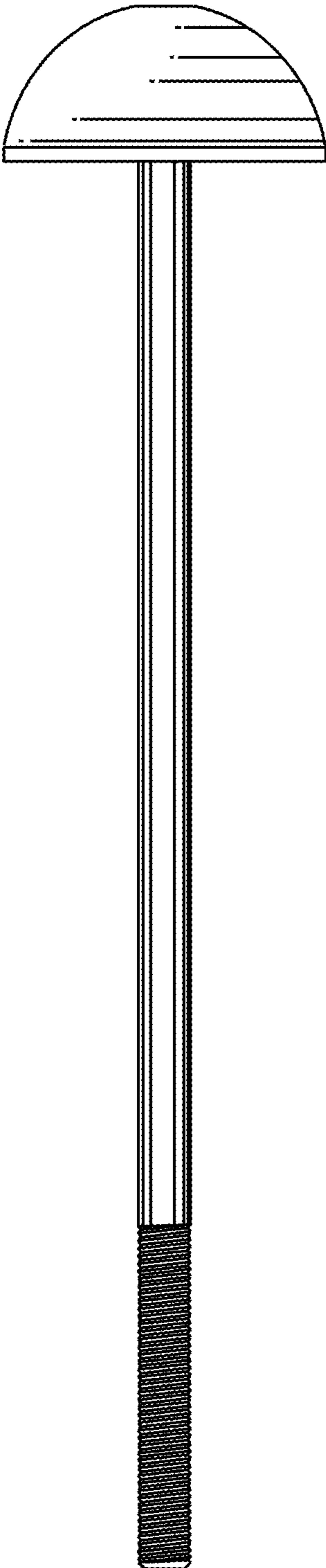

Fig. 11

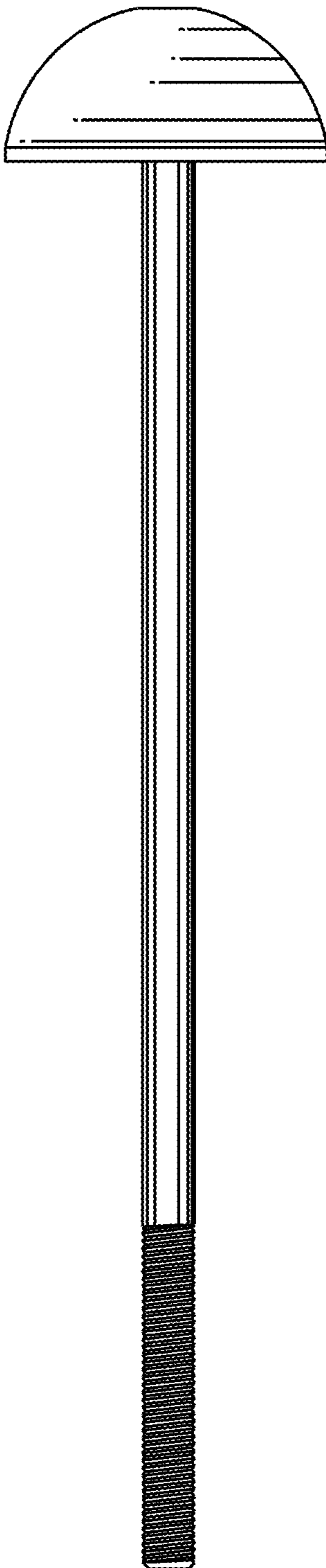

Fig. 12

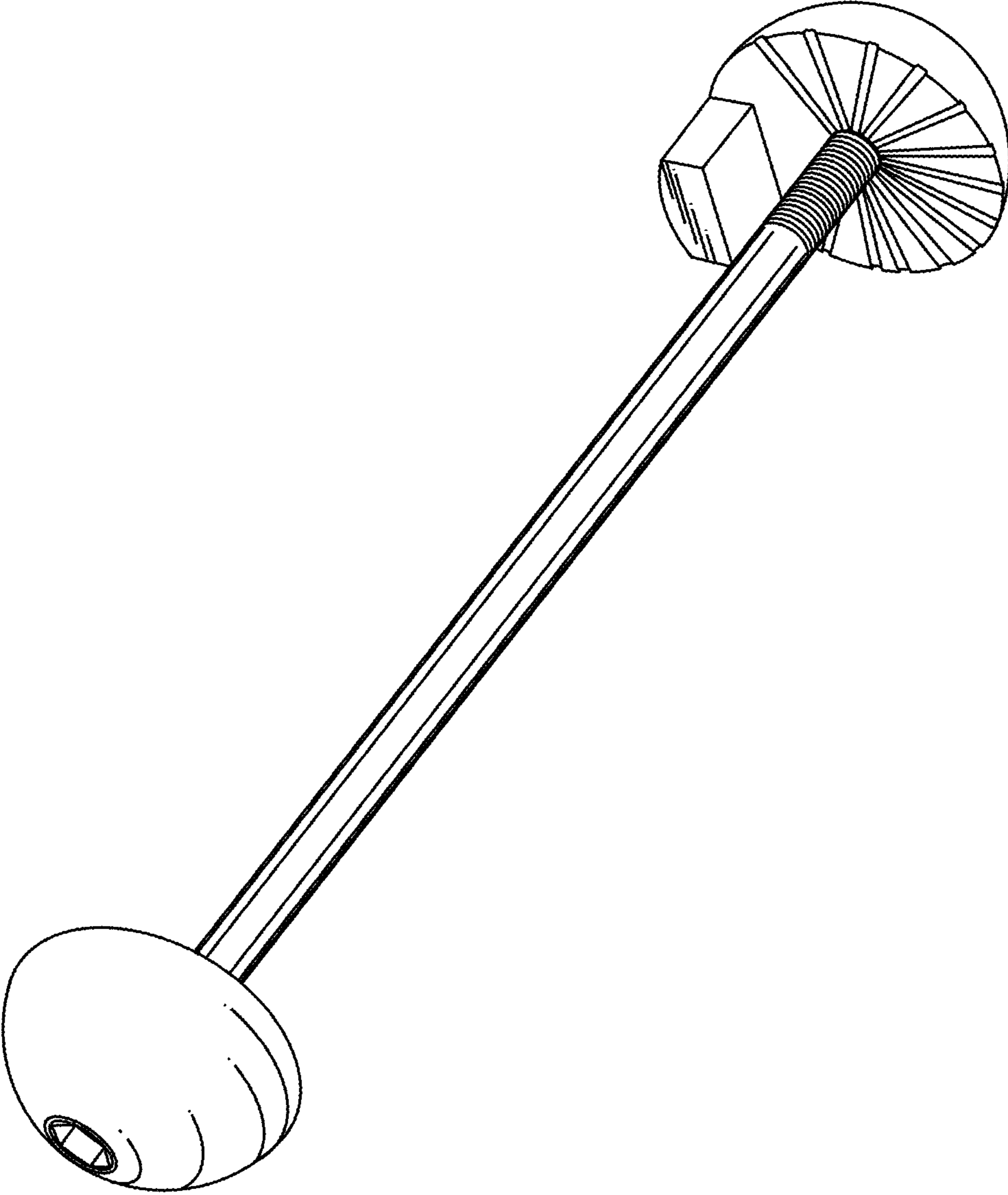

Fig. 13