



US00D741754S

(12) **United States Design Patent**  
**Cusack**

(10) **Patent No.:** **US D741,754 S**  
(45) **Date of Patent:** **\*\* Oct. 27, 2015**

(54) **BOTTLE HOLDER**

(71) Applicant: **Doug Cusack**, Cottage Grove, WI (US)

(72) Inventor: **Doug Cusack**, Cottage Grove, WI (US)

(73) Assignee: **Trek Bicycle Corporation**, Waterloo, WI (US)

(\*\*) Term: **14 Years**

(21) Appl. No.: **29/462,983**

(22) Filed: **Aug. 12, 2013**

(51) **LOC (10) Cl.** ..... **12-11**

(52) **U.S. Cl.**  
USPC ..... **D12/114**

(58) **Field of Classification Search**  
USPC ..... D12/114; 224/457, 414; 190/103;  
220/560; 206/457; 248/311.2, 215;  
D7/620; 70/233, 18, 30  
CPC ..... B62J 7/04; B62J 11/00; B62J 9/00;  
B62J 9/001; B62J 7/08; B62J 7/00; B62K  
27/003; B62K 27/12  
See application file for complete search history.

(56) **References Cited**

**U.S. PATENT DOCUMENTS**

D337,288 S \* 7/1993 Ringle' ..... D12/114  
D348,641 S \* 7/1994 Tsushi ..... D12/411  
D460,572 S \* 7/2002 Lee ..... D26/26  
D463,219 S \* 9/2002 Tsai ..... D7/620  
6,637,244 B2 \* 10/2003 Haraughty ..... 70/233

D491,018 S \* 6/2004 Vinarsky ..... D7/507  
D594,706 S \* 6/2009 Bernard ..... D7/620  
8,602,278 B2 \* 12/2013 Sweigart ..... 224/414  
2004/0256428 A1 \* 12/2004 Meggiolan ..... 224/414  
2005/0156001 A1 \* 7/2005 Dal Pra et al. .... 224/414  
2006/0284040 A1 \* 12/2006 Nixon et al. .... 248/311.2  
2011/0056907 A1 \* 3/2011 Willows et al. .... 215/382  
2011/0147423 A1 \* 6/2011 Serpell ..... 224/414  
2012/0037677 A1 \* 2/2012 Valiquette ..... 224/414  
2012/0104063 A1 \* 5/2012 Sweigart ..... 224/414  
2012/0125963 A1 \* 5/2012 Awh ..... 224/457  
2012/0228175 A1 \* 9/2012 Ressel et al. .... 206/457  
2013/0087572 A1 \* 4/2013 Dinges et al. .... 220/737  
2013/0270315 A1 \* 10/2013 Tsai ..... 224/414  
2014/0110202 A1 \* 4/2014 Vesterby ..... 190/103

\* cited by examiner

*Primary Examiner* — Robert M Spear  
*Assistant Examiner* — Ryan Harvey

(57) **CLAIM**

The ornamental design for a bottle holder, as shown and described.

**DESCRIPTION**

FIG. 1 is a side view of a bottle holder showing my new design;  
FIG. 2 is a top view thereof;  
FIG. 3 is a bottom view thereof;  
FIG. 4 is rear view thereof;  
FIG. 5 is a front view thereof;  
FIG. 6 is a first perspective view thereof; and,  
FIG. 7 is a second perspective view thereof.

**1 Claim, 7 Drawing Sheets**

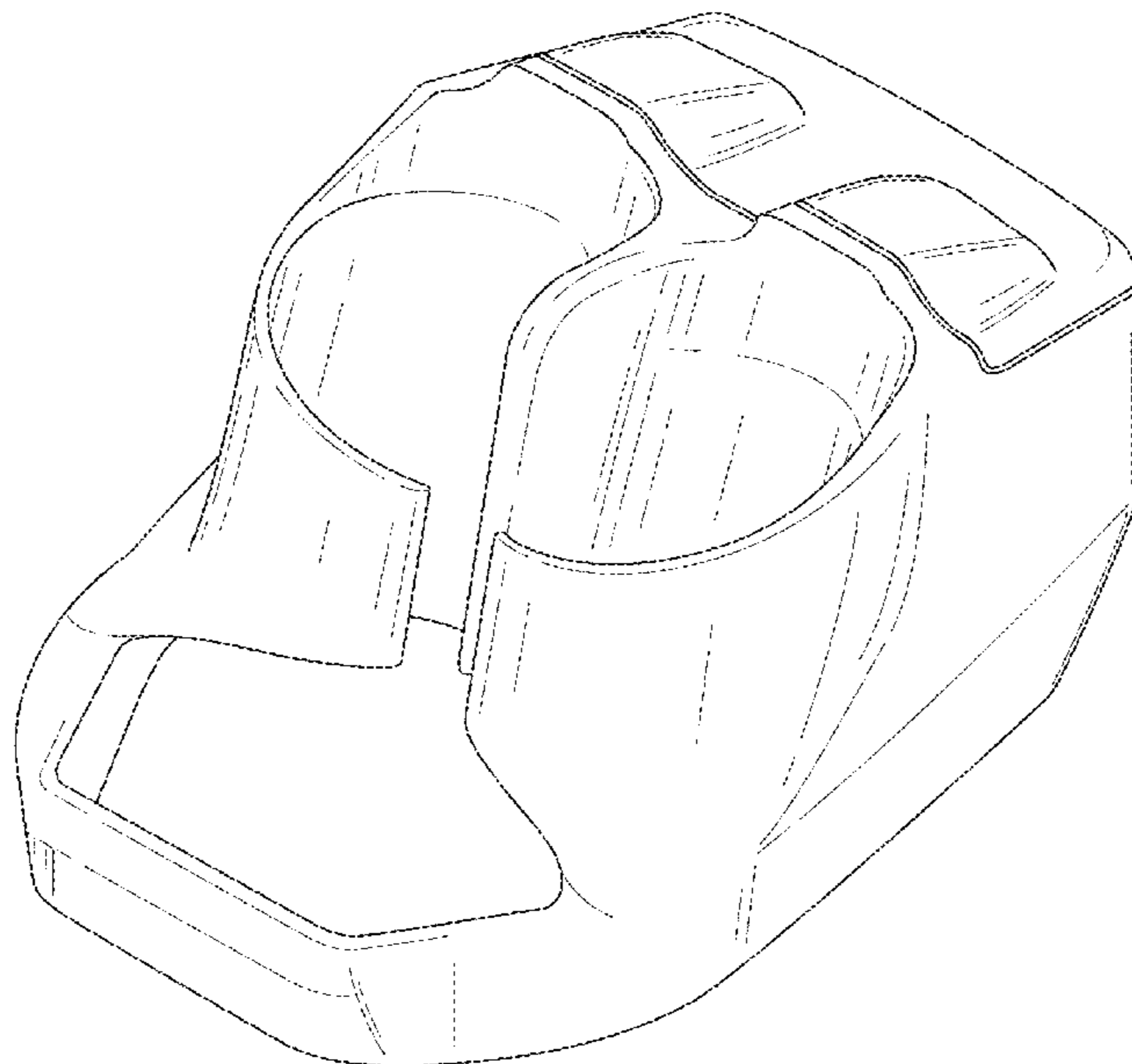

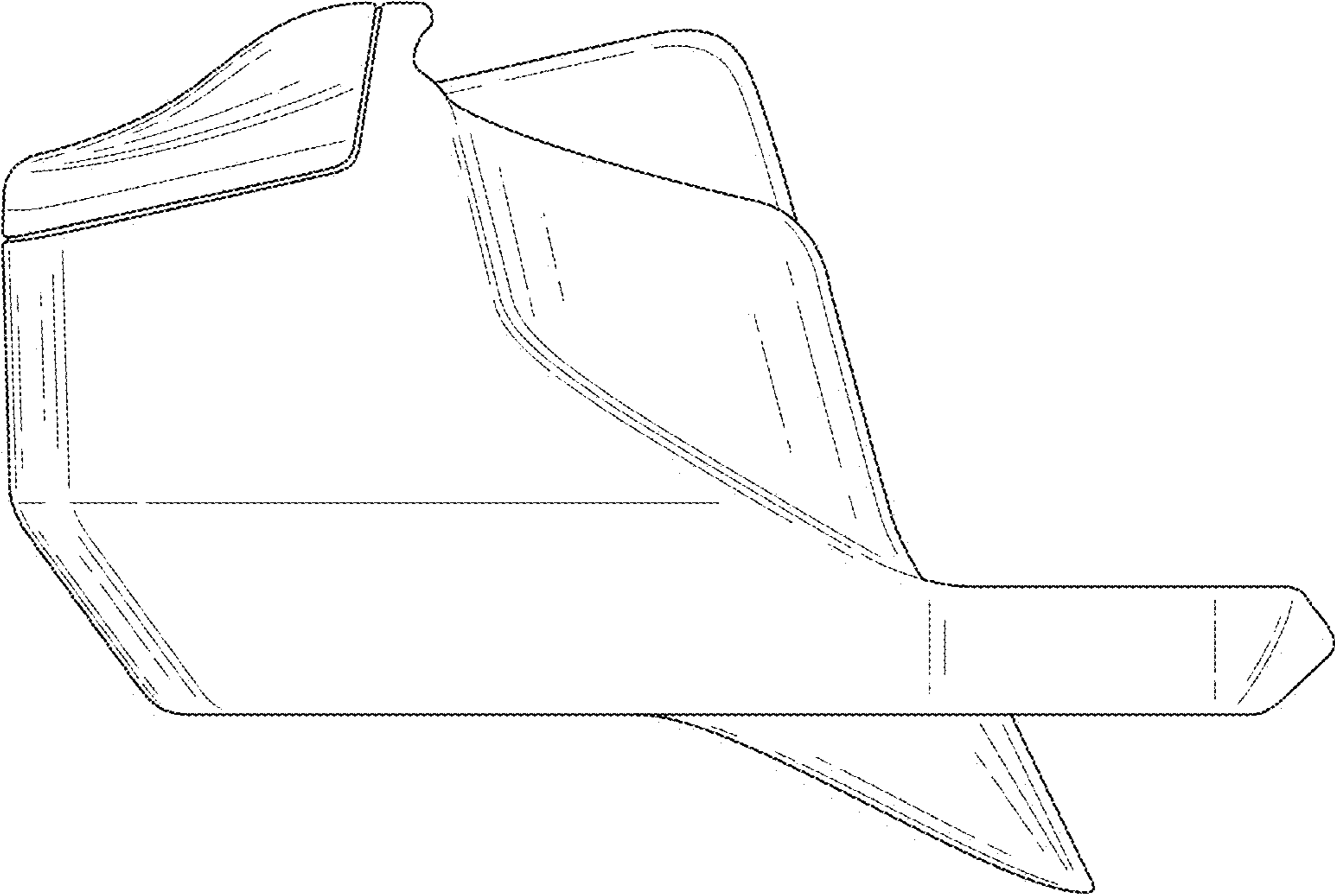

FIG. 1

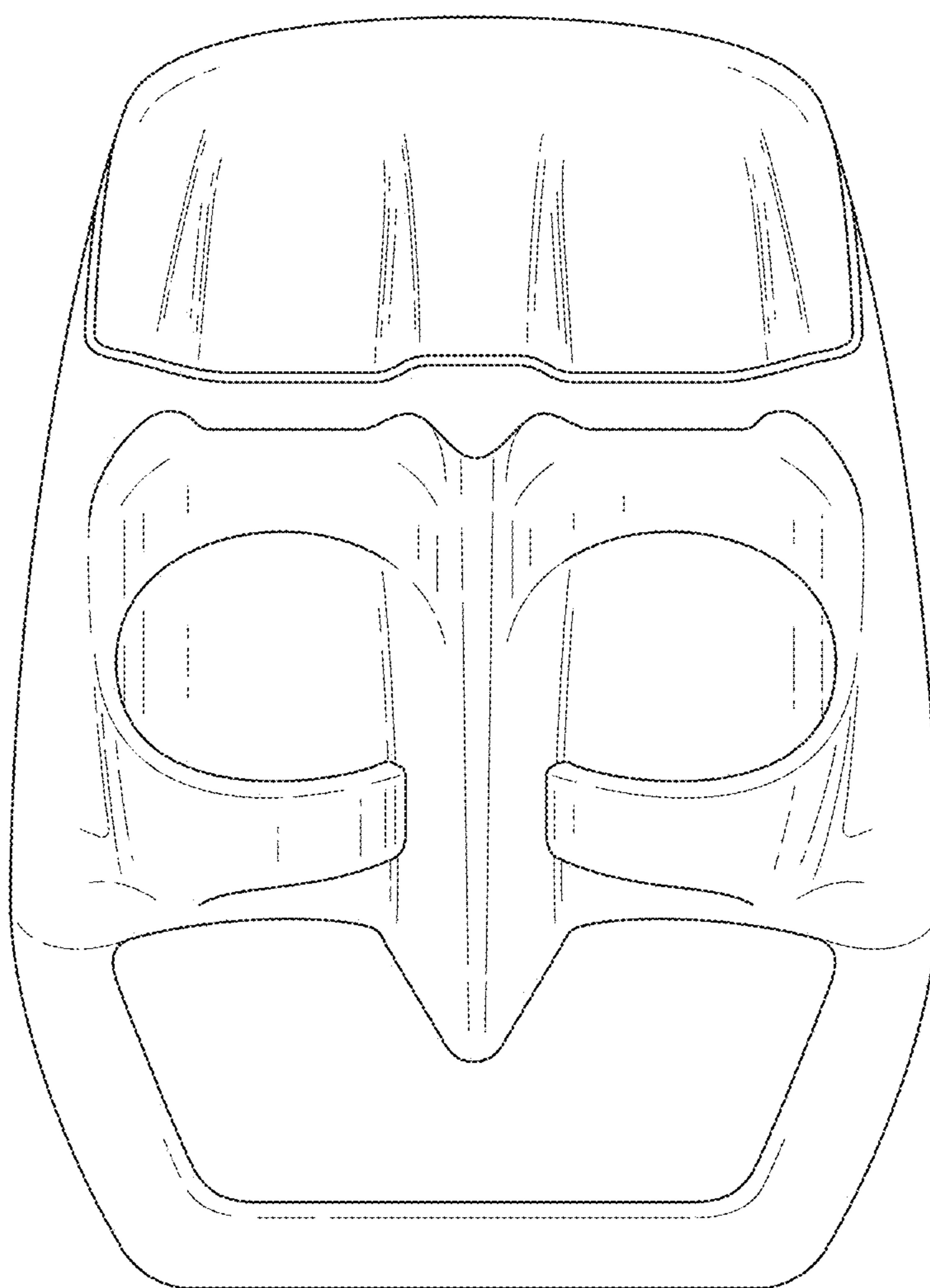

FIG. 2

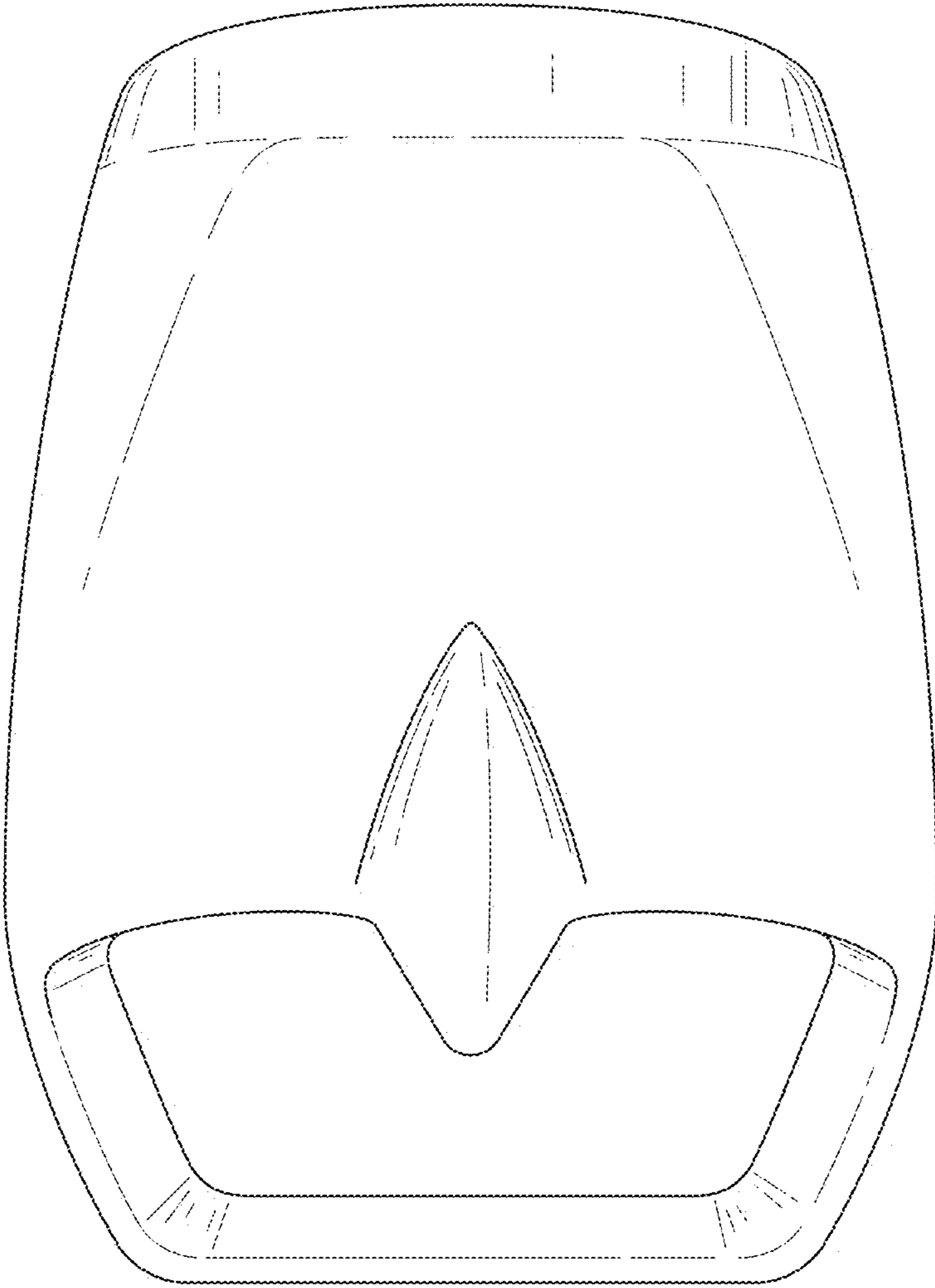

FIG. 3

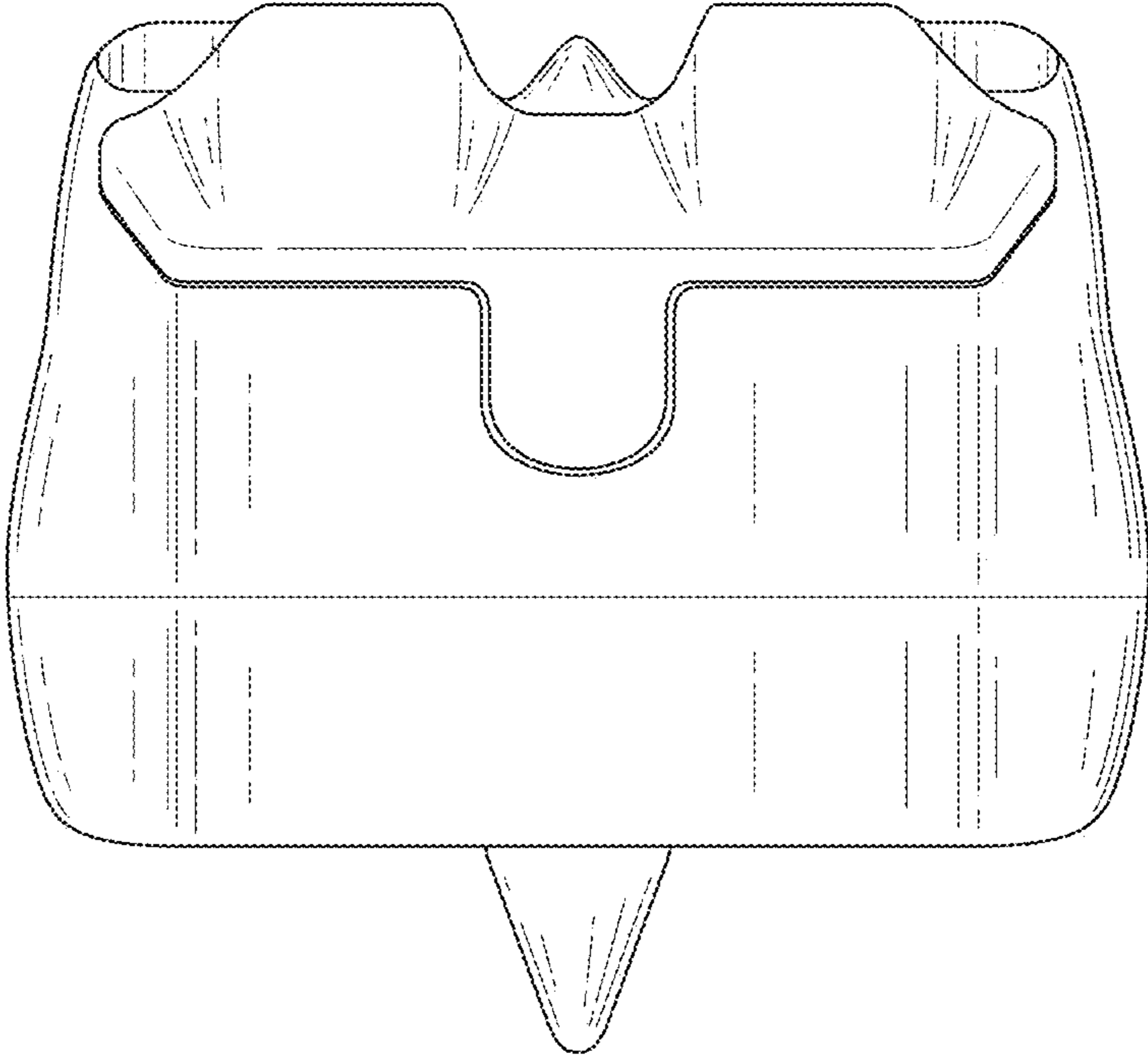

FIG. 4

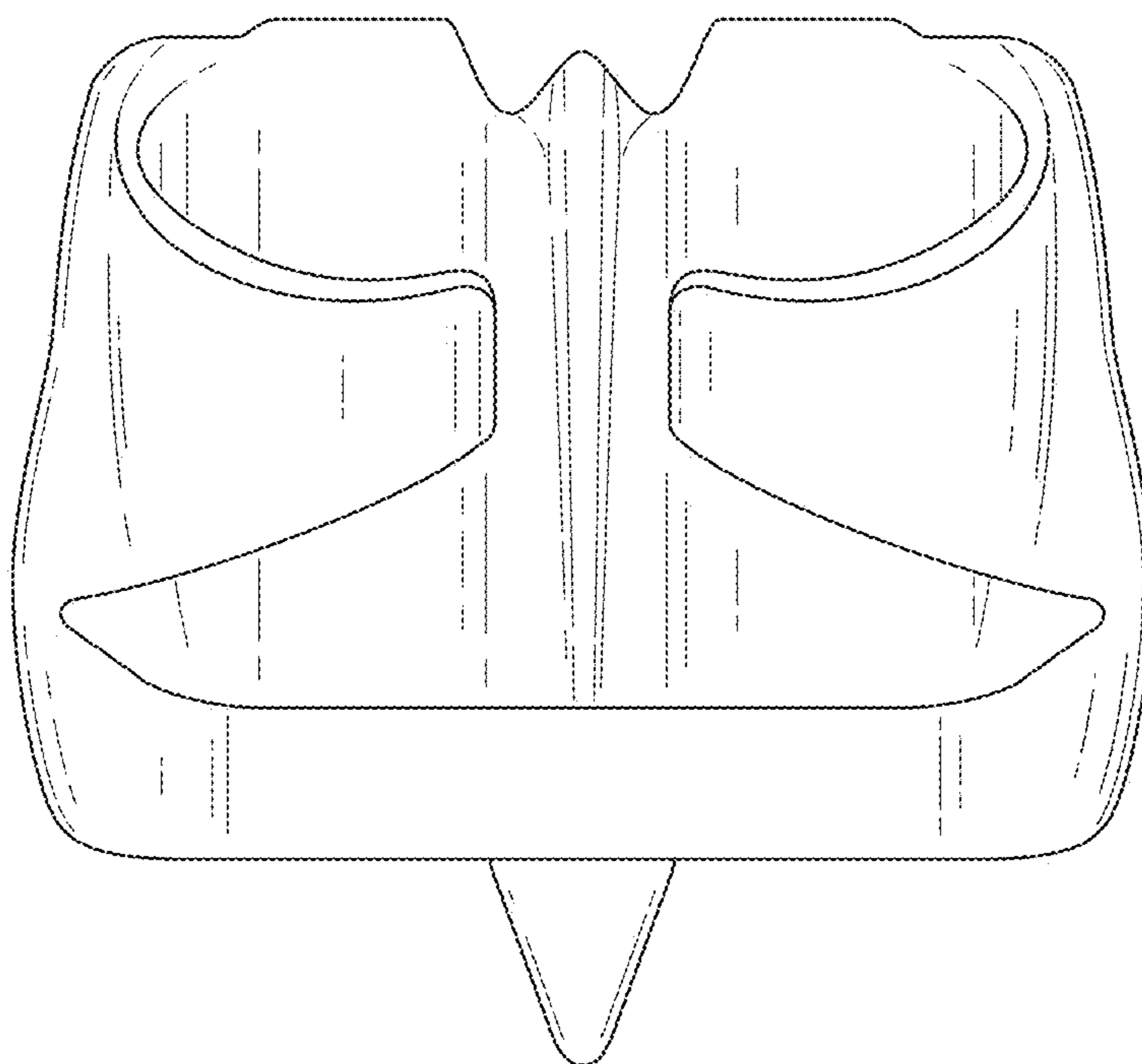

FIG. 5

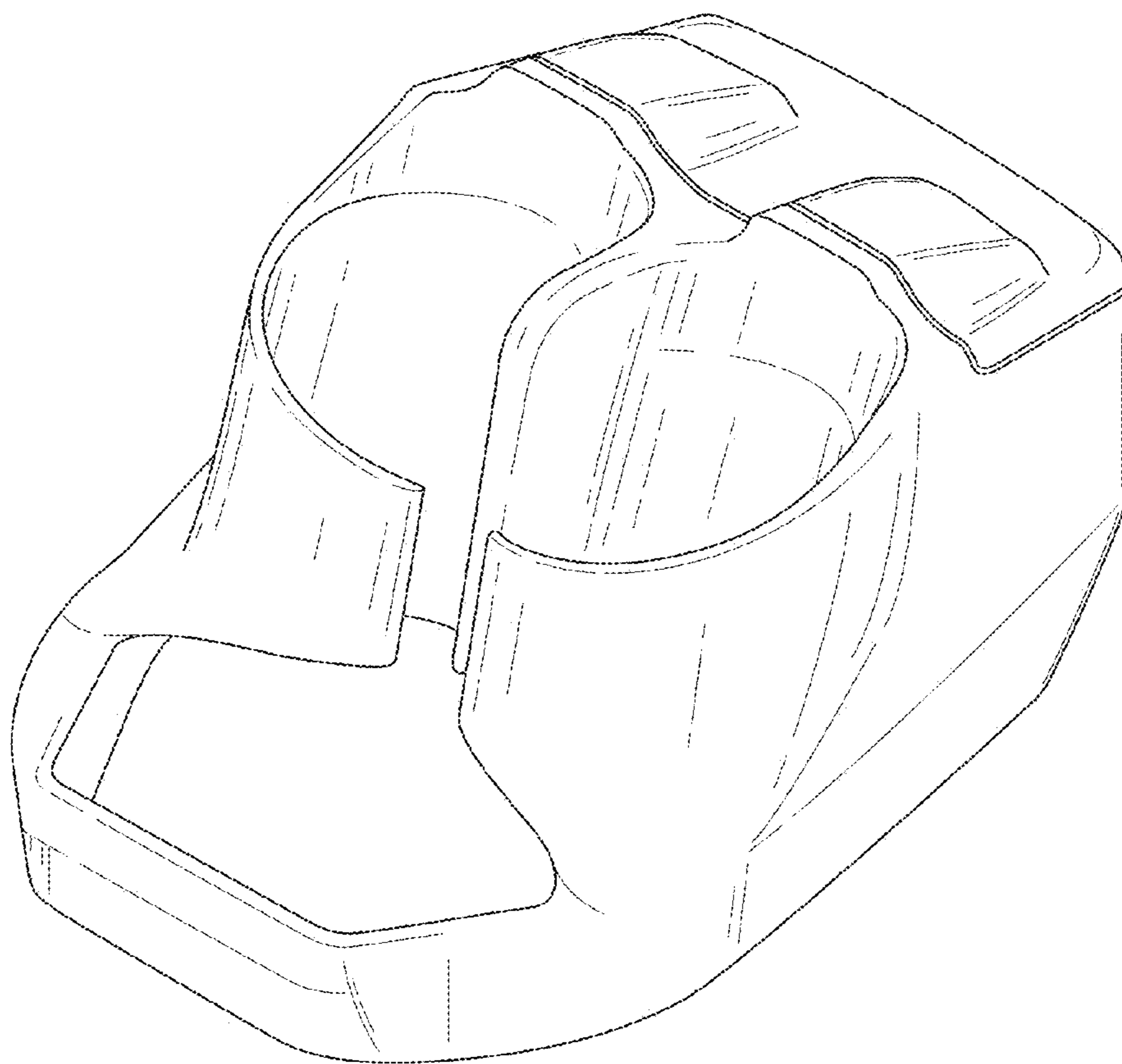

FIG. 6

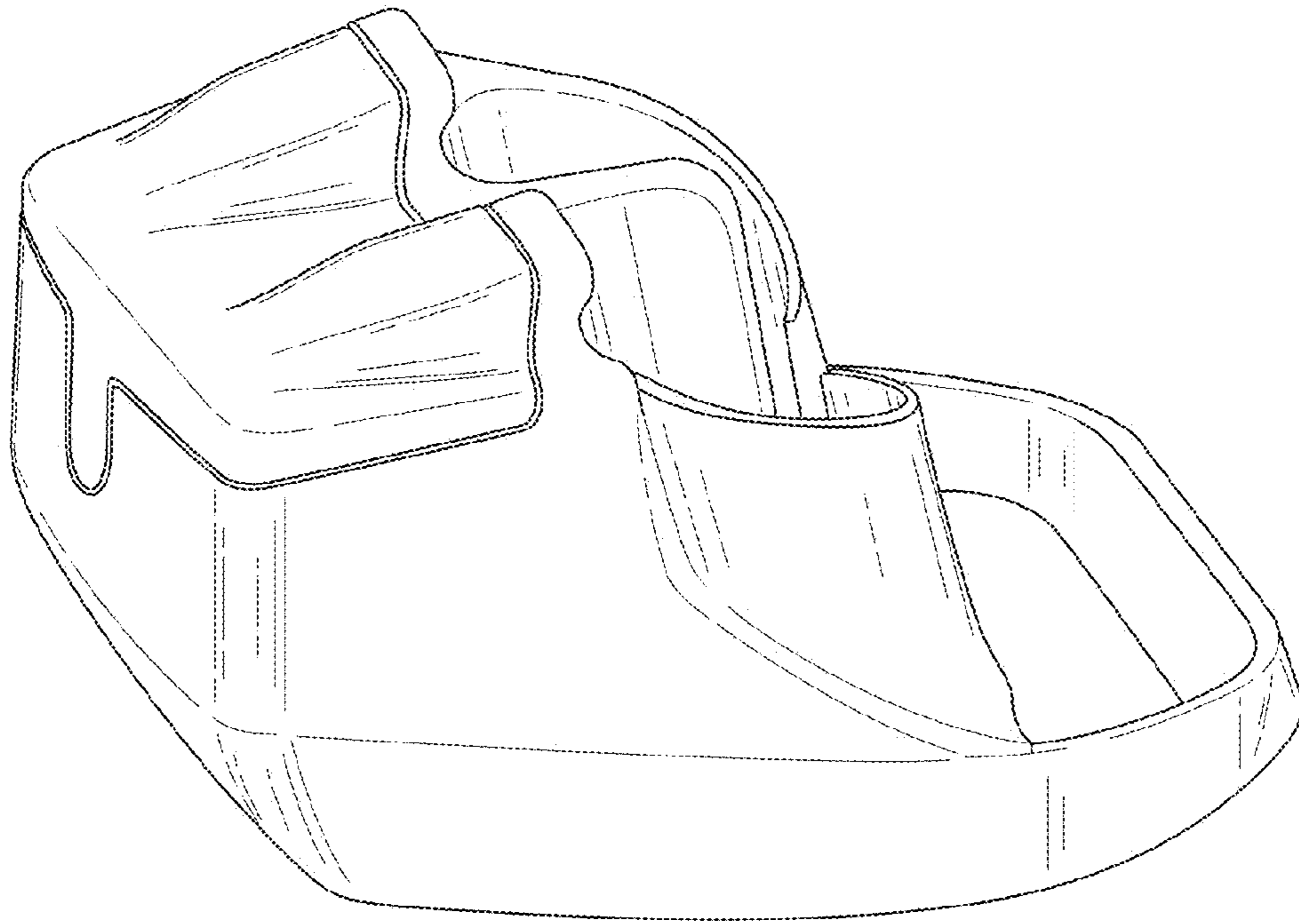

FIG. 7