



US00D741748S

(12) **United States Design Patent**  
**Ng**

(10) **Patent No.:** **US D741,748 S**  
(45) **Date of Patent:** **\*\* Oct. 27, 2015**

(54) **SLIDE FASTENER**

(71) Applicant: **Wang Lap Ronny Ng**, New Territories  
(HK)

(72) Inventor: **Wang Lap Ronny Ng**, New Territories  
(HK)

(\*\*) Term: **14 Years**

(21) Appl. No.: **29/494,084**

(22) Filed: **Jun. 17, 2014**

(30) **Foreign Application Priority Data**

Dec. 18, 2013 (HK) ..... 1302261

(51) **LOC (10) Cl.** ..... **02-07**

(52) **U.S. Cl.**  
USPC ..... **D11/221**

(58) **Field of Classification Search**

USPC ..... D11/200-201, 221; 24/381-383,  
24/385-387, 414-431, 4, 412; 2/265;  
D2/641; 294/2, 3.6; 223/111

CPC ..... A44B 19/00; A44B 19/02; A44B 19/04;  
A44B 19/10; A44B 19/24; A44B 19/26;  
A44B 19/30; A44B 19/06

See application file for complete search history.

(56) **References Cited**

**U.S. PATENT DOCUMENTS**

2,368,911 A \* 2/1945 Andler ..... 24/381  
2,398,592 A \* 4/1946 Morin ..... 24/410  
2,660,774 A \* 12/1953 Heimann et al. .... 24/412  
5,394,593 A \* 3/1995 Aoki ..... 24/411

D712,785 S \* 9/2014 Ng ..... D11/221  
D724,996 S \* 3/2015 Hung ..... D11/221  
D732,424 S \* 6/2015 Ng ..... D11/221  
D732,425 S \* 6/2015 Ng ..... D11/221

\* cited by examiner

*Primary Examiner* — Ralf Seifert

(74) *Attorney, Agent, or Firm* — Gloria Tsui-Yip, Esq.;  
Miskin & Tsui-Yip LLP

(57) **CLAIM**

The ornamental design for a slide fastener, as shown and described.

**DESCRIPTION**

FIG. 1 is a front elevational view of one element of my new design;

FIG. 2 is a top plan view thereof;

FIG. 3 is a rear elevational view thereof;

FIG. 4 is a bottom plan view thereof;

FIG. 5 is a left side view thereof;

FIG. 6 is a right side view thereof;

FIG. 7 is a top and left perspective view thereof;

FIG. 8 is a bottom and right perspective view thereof;

FIG. 9 is a front elevational view of a plurality of elements of my new design interlocking with each other in a closed position;

FIG. 10 is a perspective view thereof; and,

FIG. 11 is a perspective view of a plurality of elements of my new design interlocking with each other in a partially open position.

The broken line showing of the planar surfaces where the elements are attached in FIG. 11 illustrate environmental matter which form no part of the claimed design.

**1 Claim, 4 Drawing Sheets**

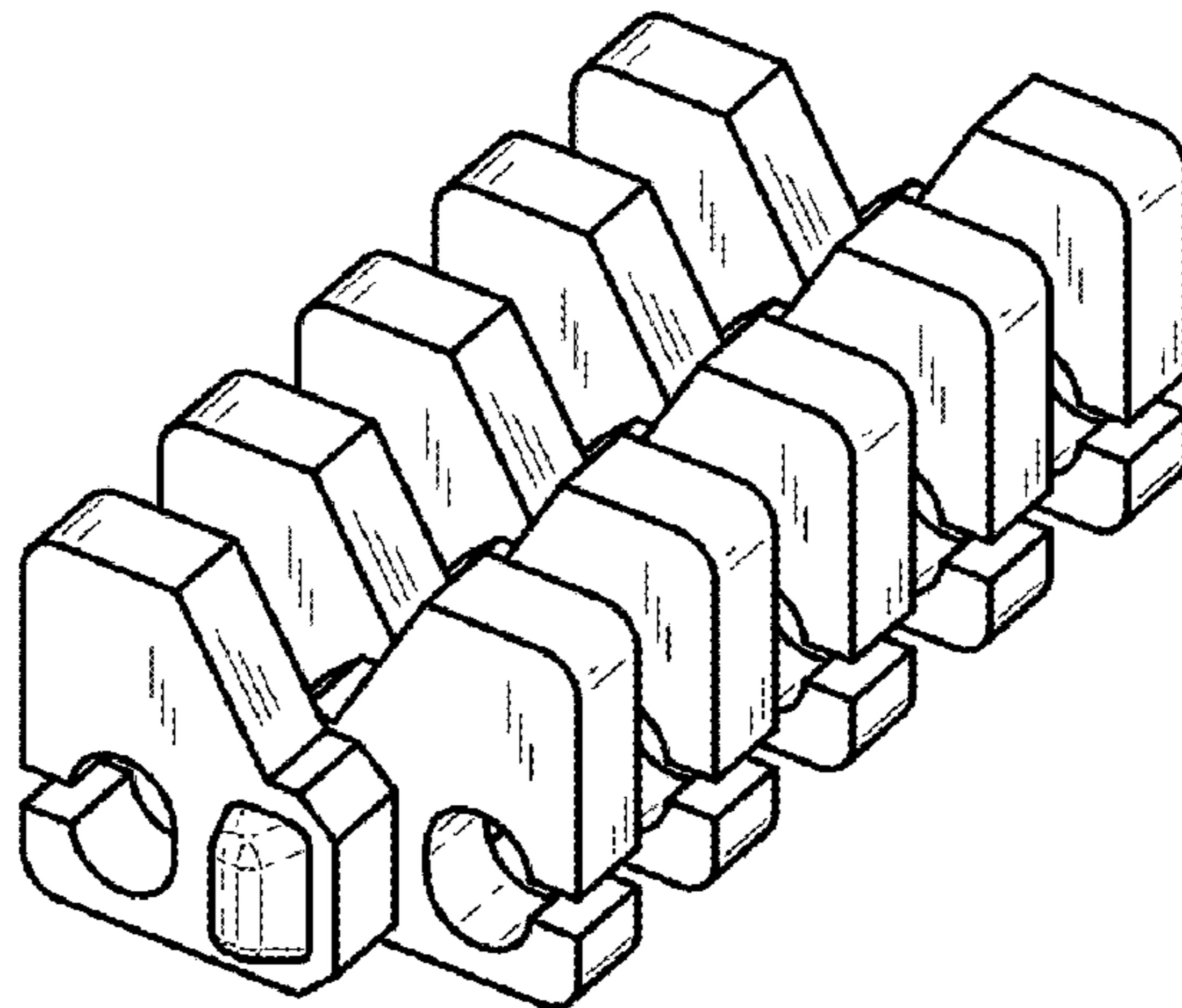

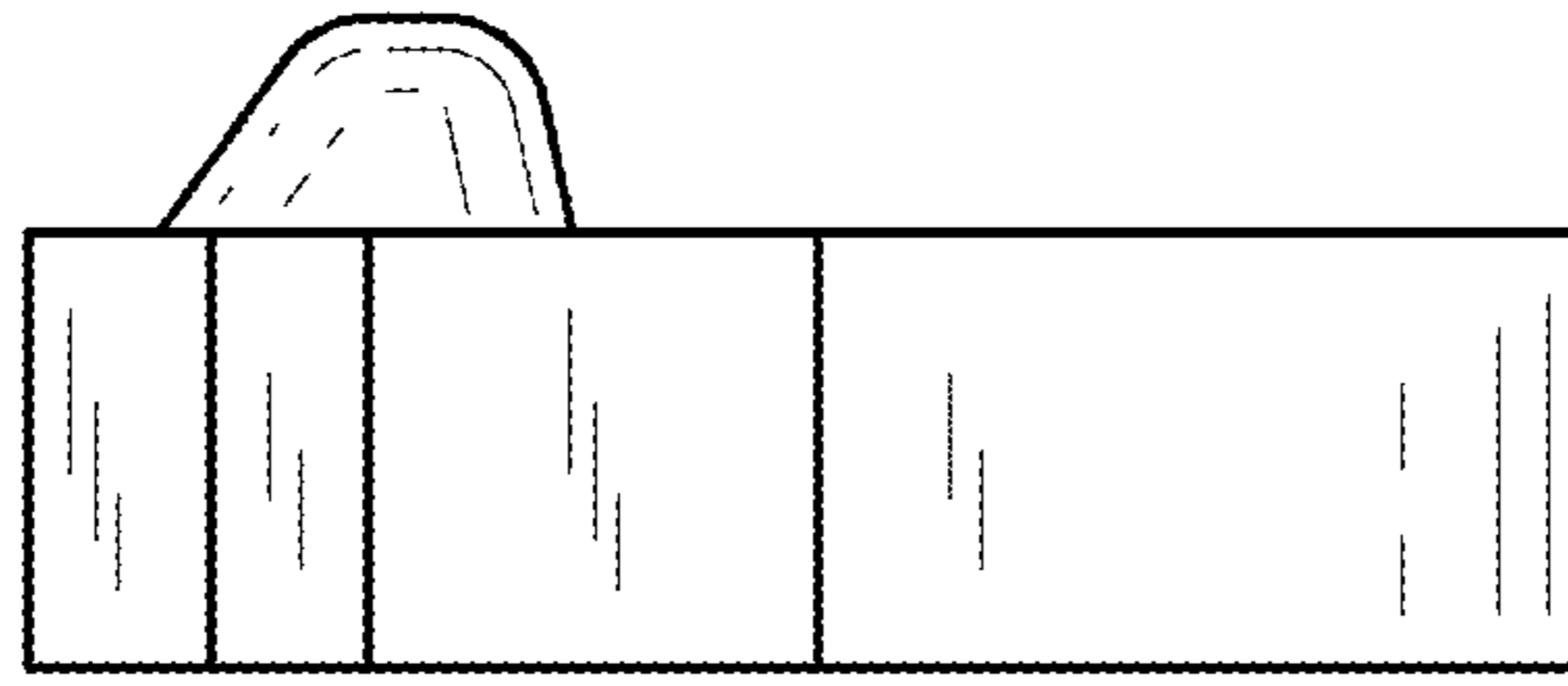

Fig.1

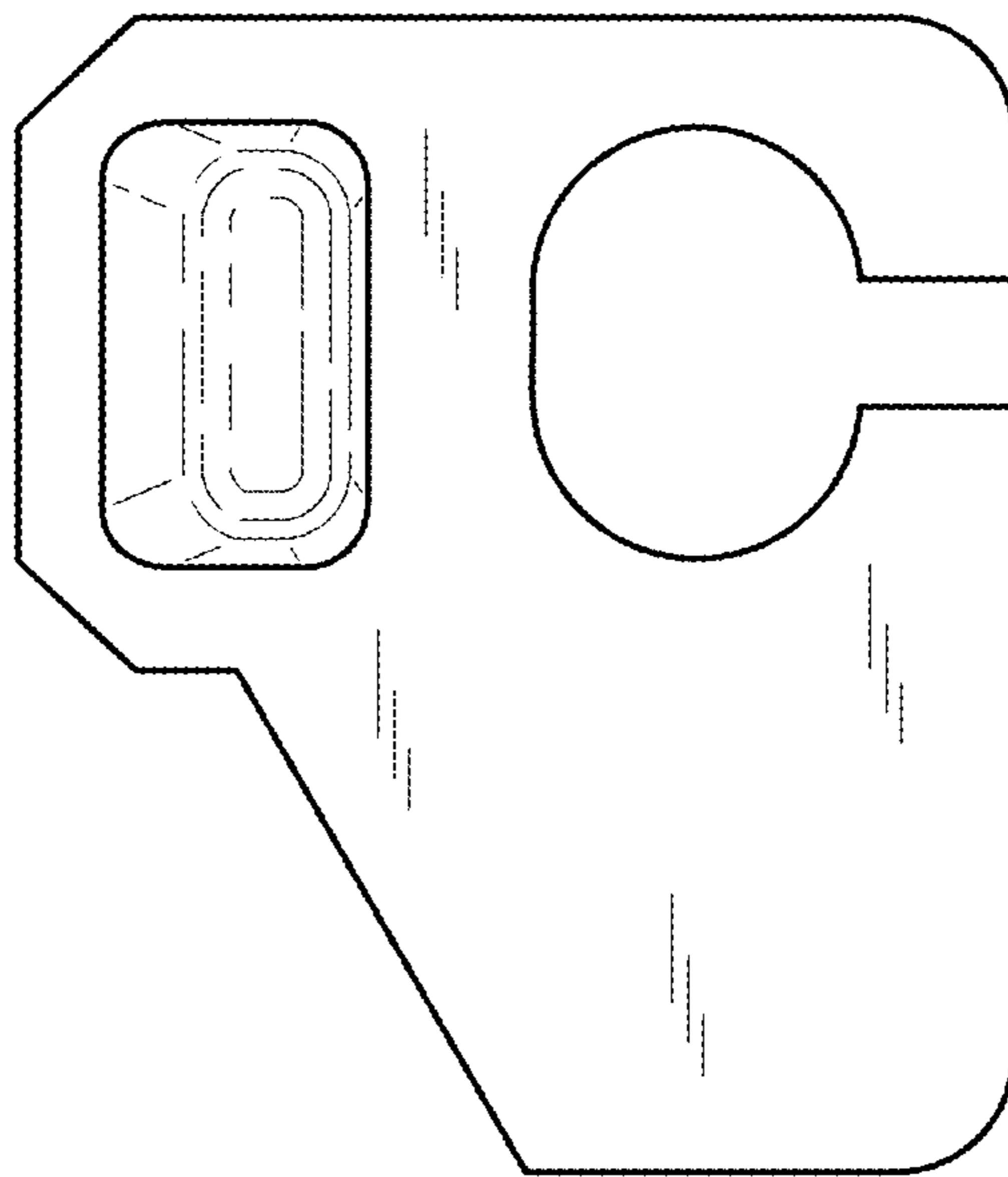

Fig.2

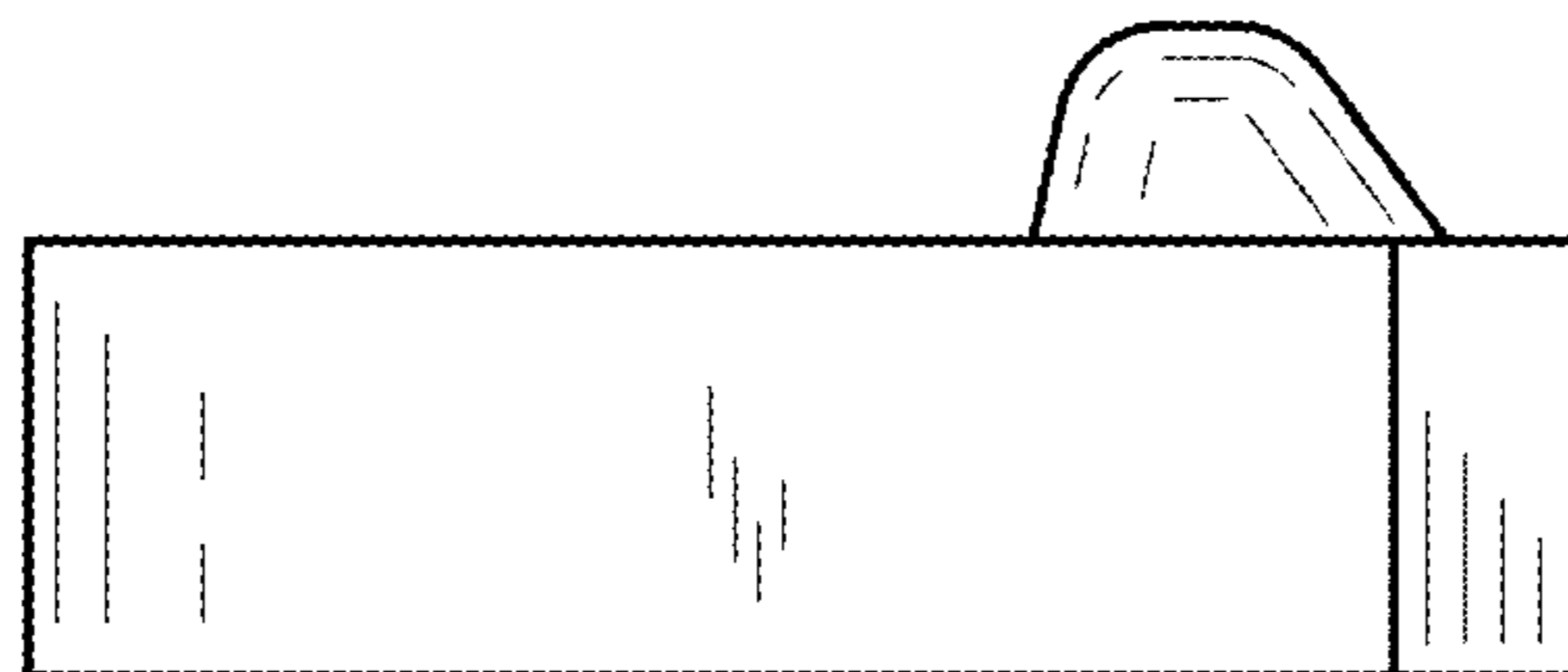

Fig.3

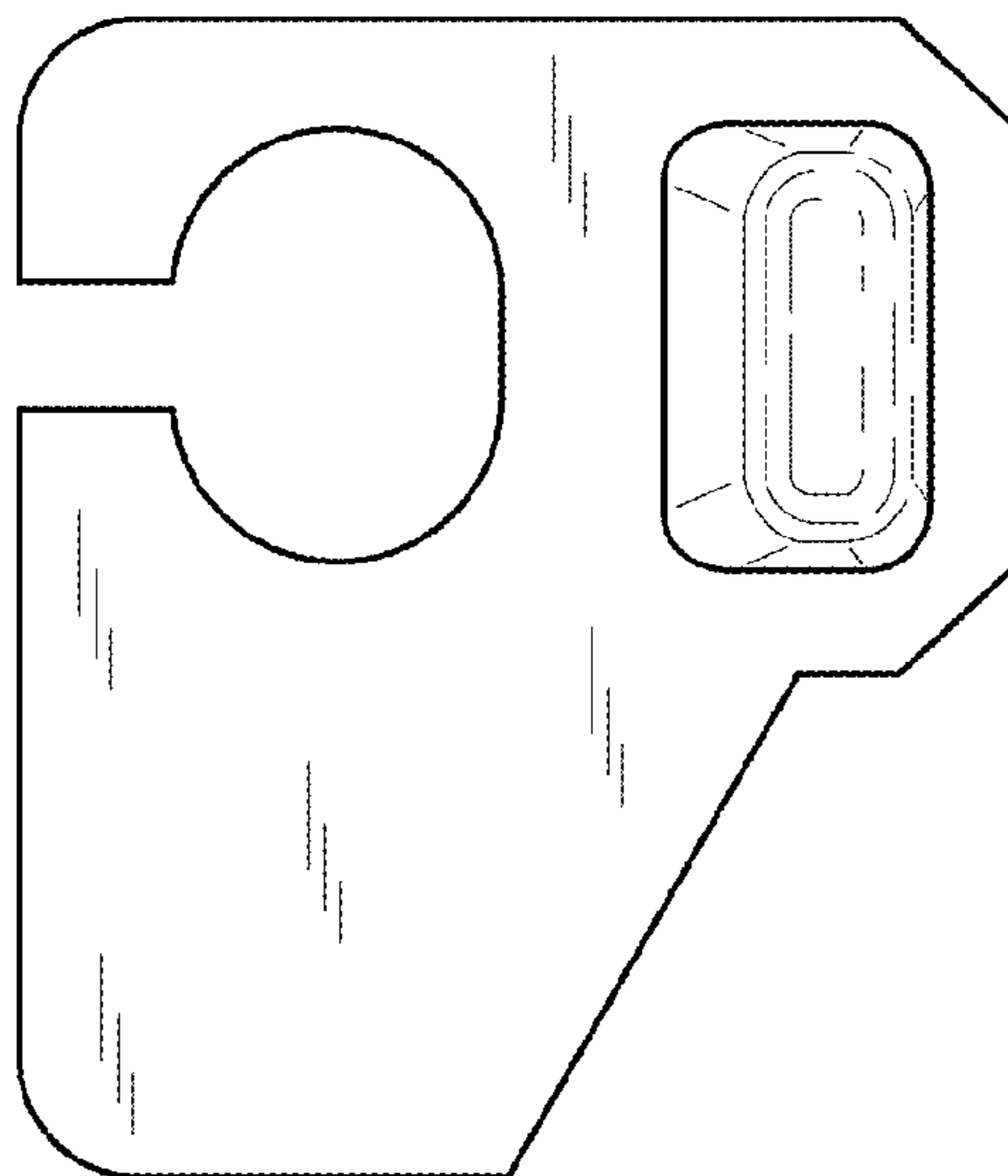

Fig.4

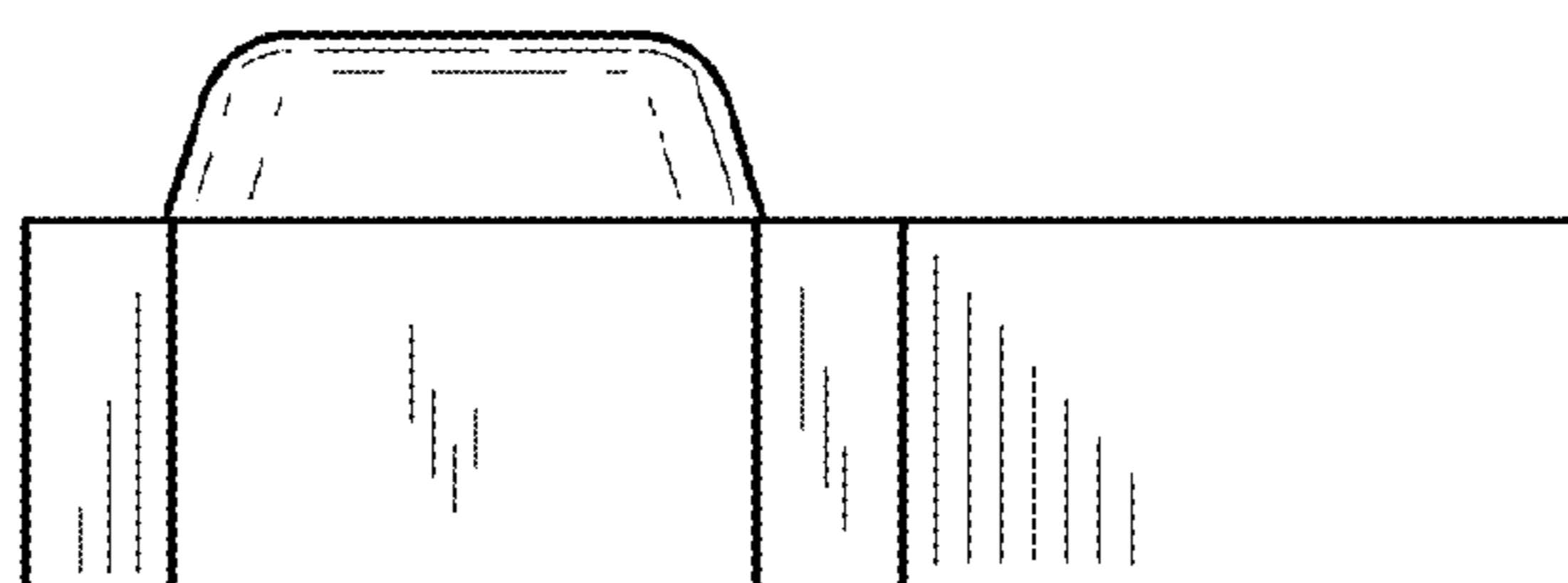

Fig.5

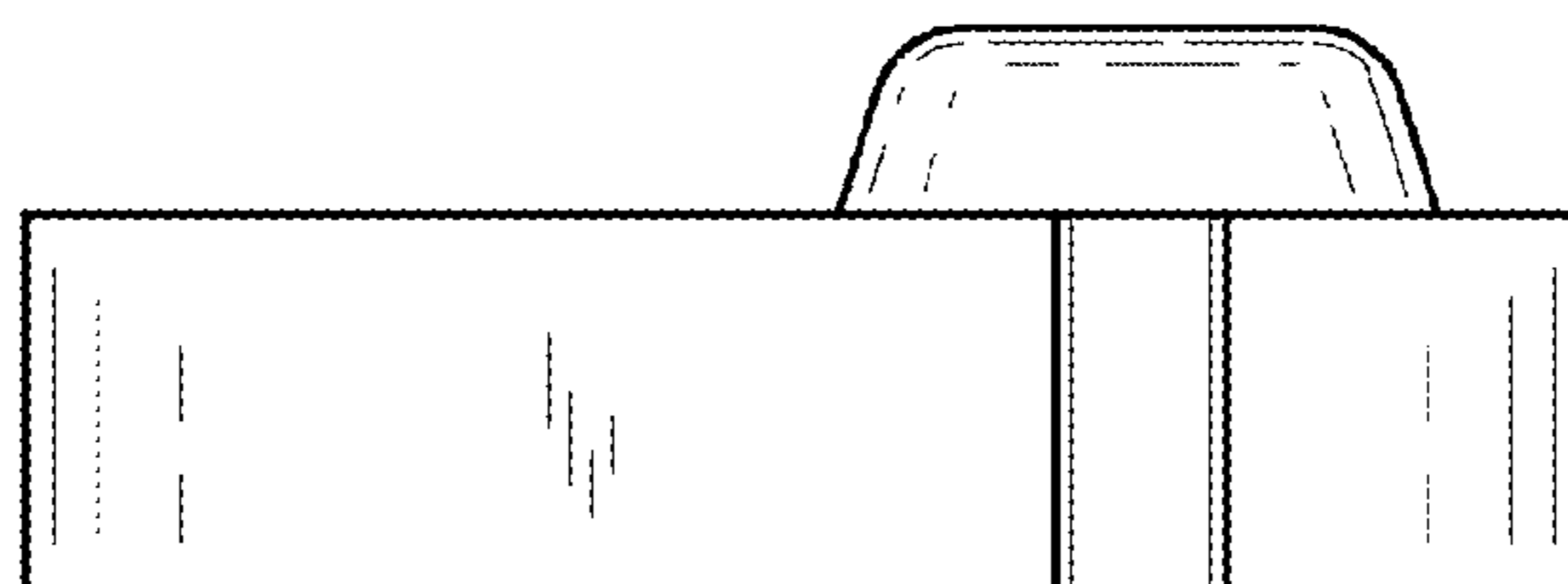

Fig.6

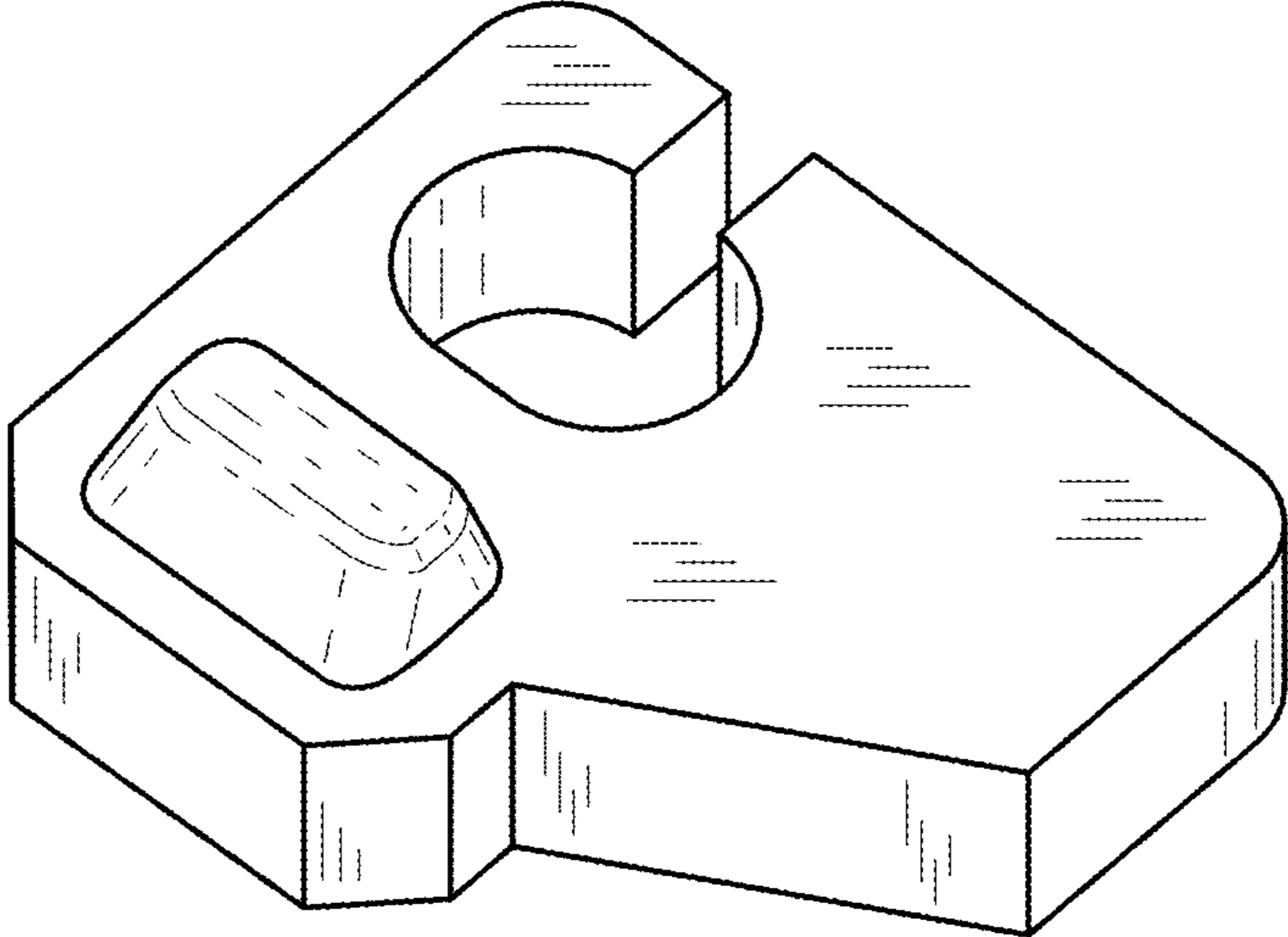

Fig.7

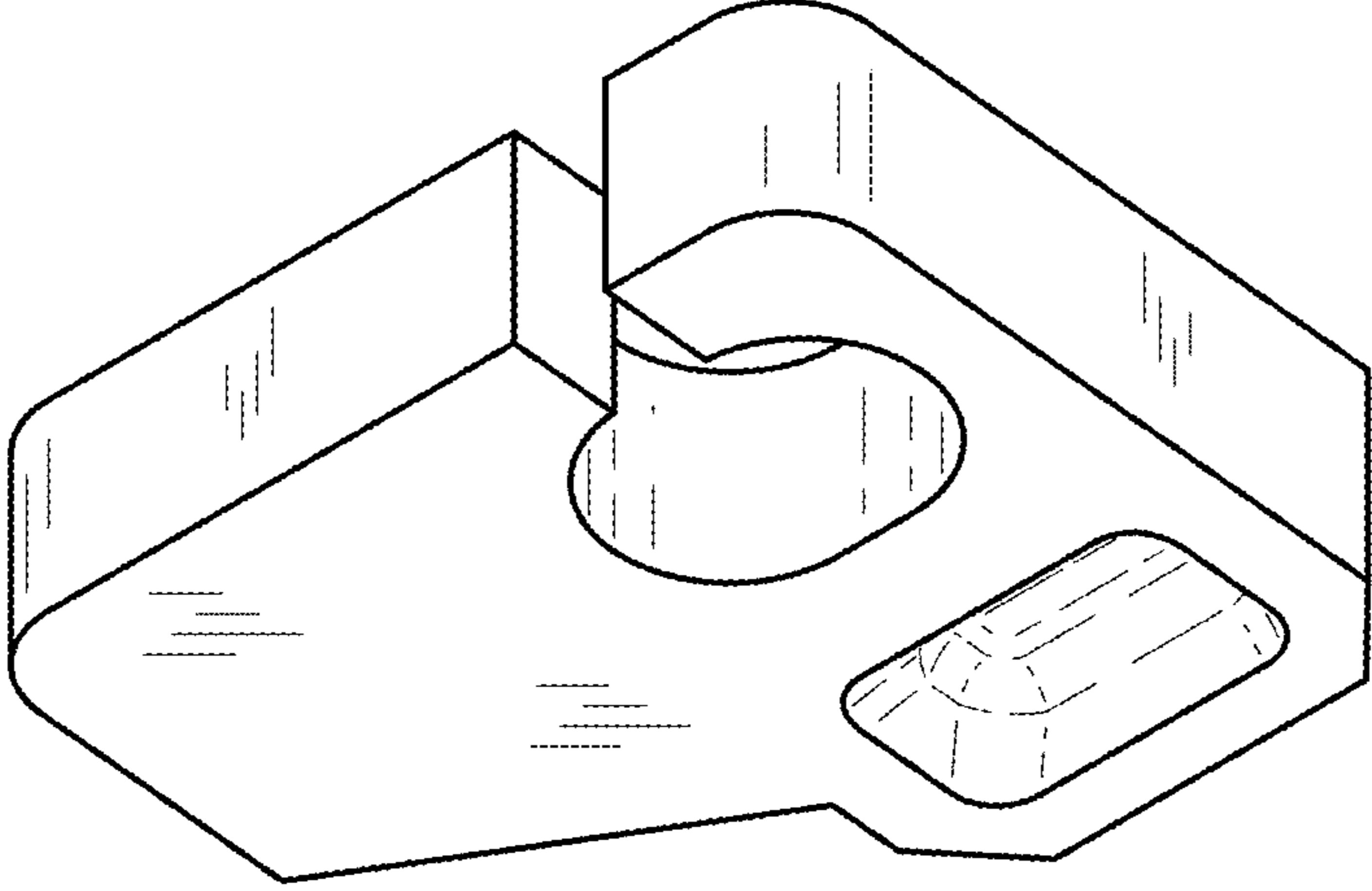

Fig.8

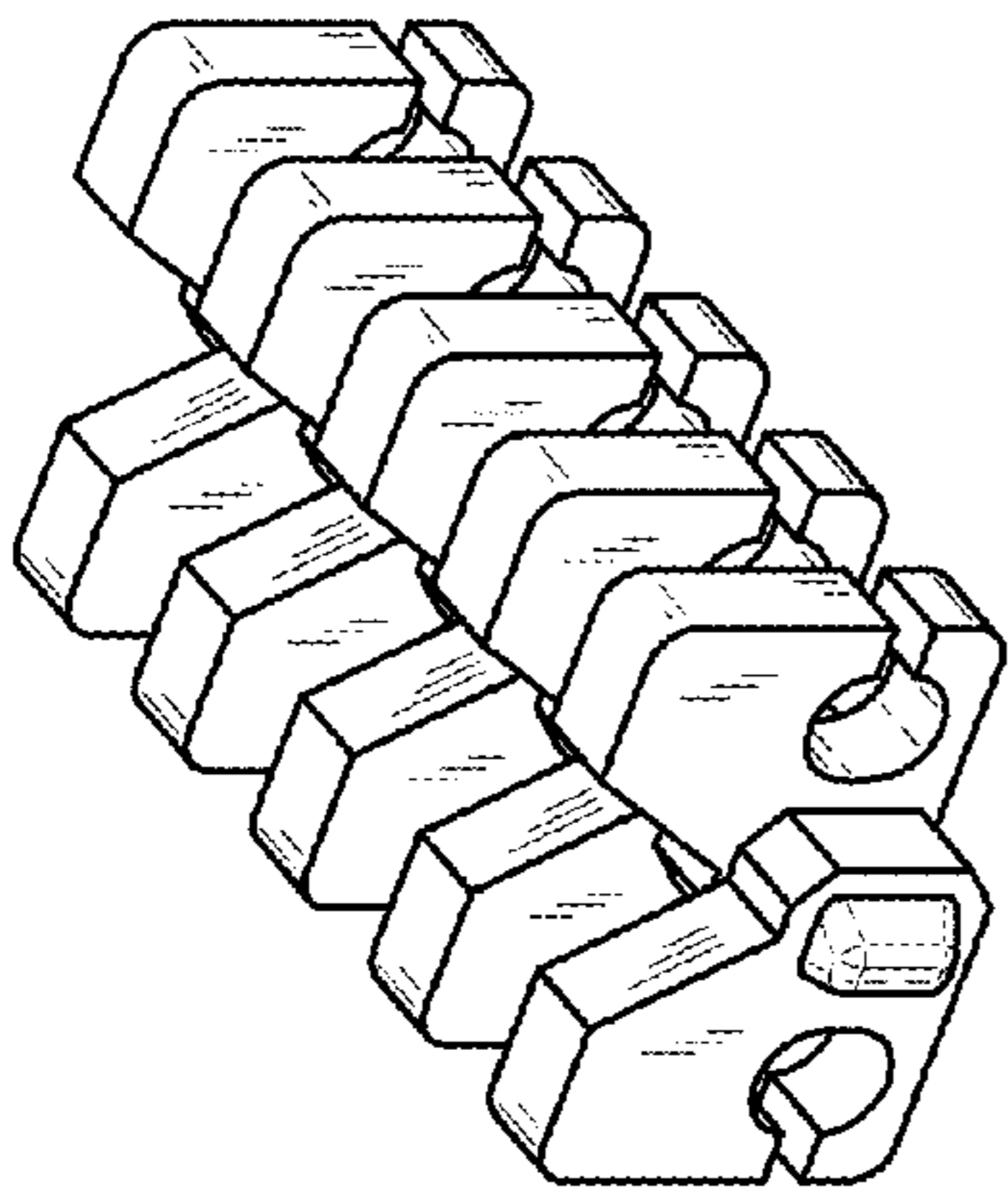

Fig. 10

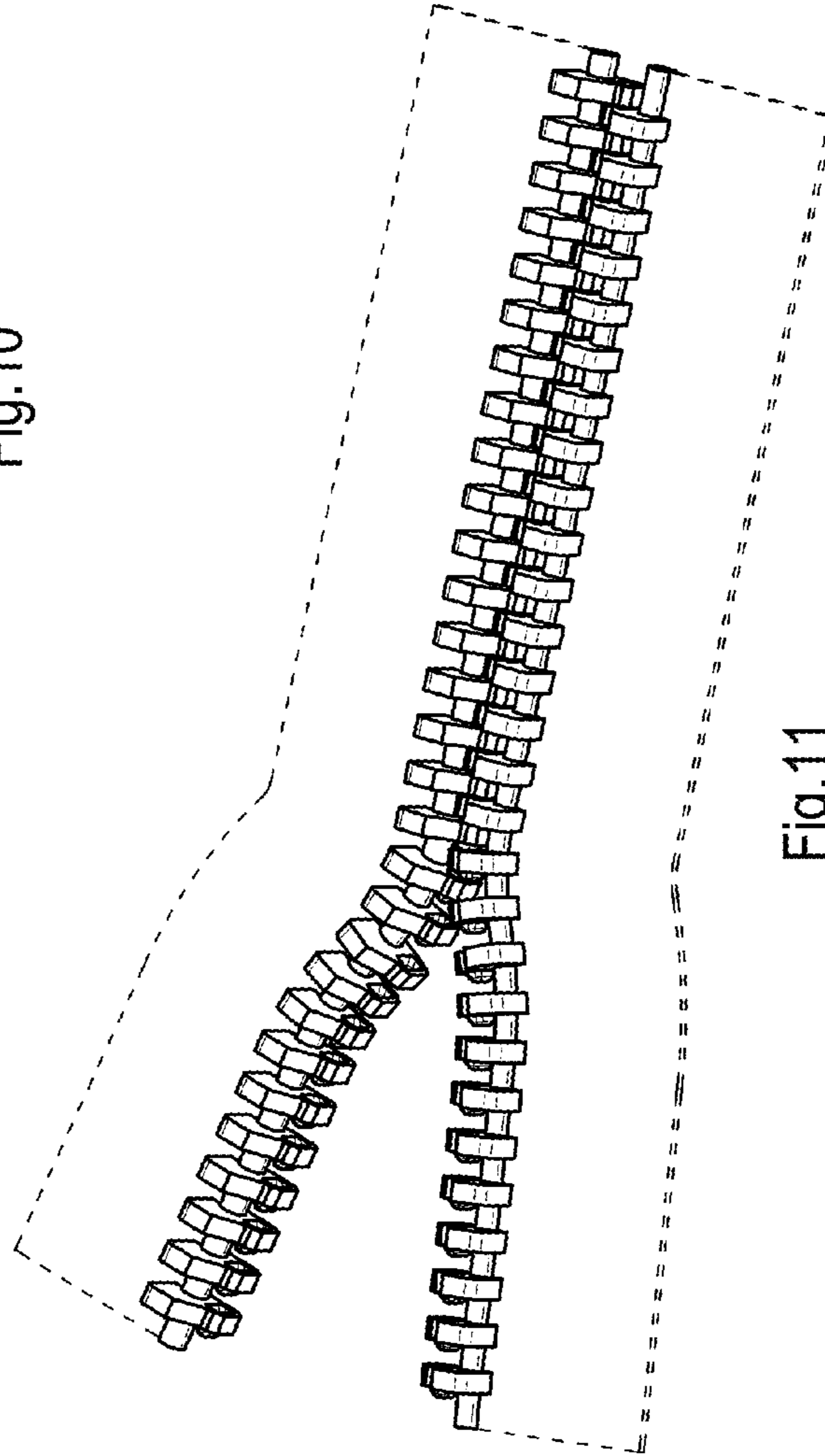

Fig. 11

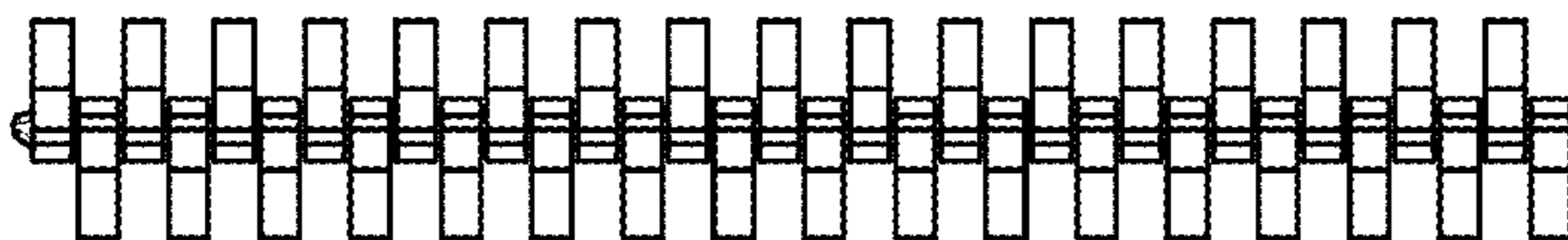

Fig. 9