



US00D741720S

(12) **United States Design Patent**  
**Anandani**

(10) **Patent No.:** **US D741,720 S**  
(45) **Date of Patent:** **\*\* Oct. 27, 2015**

(54) **RECTANGULAR PERFUME BOTTLE**

(71) Applicant: **Kirti Anandani**, Hackensack, NJ (US)

(72) Inventor: **Kirti Anandani**, Hackensack, NJ (US)

(\*\*) Term: **14 Years**

(21) Appl. No.: **29/496,862**

(22) Filed: **Jul. 17, 2014**

(51) **LOC (10) Cl.** ..... **09-01**

(52) **U.S. Cl.**  
USPC ..... **D9/560**

(58) **Field of Classification Search**

USPC ..... D3/202, 203.2, 901; D4/116; D7/313,  
D7/401.1, 590-612, 619.1, 705; D9/502,  
D9/504, 506, 519, 520, 522, 523, 526, 529,  
D9/530, 549, 558, 559, 560, 563, 564, 569,  
D9/571, 574, 682, 686, 687, 689, 719;  
D19/93; D21/684; D23/211.1-211.2,  
D23/366; D24/121, 124, 197, 224; D28/4,  
D28/7, 20, 66, 76, 82, 83, 85, 88, 89, 91.1;  
D32/29.1; D34/1, 2, 11, 39; 215/62.22,  
215/220, 329, 382-385, 396, 398; 220/669,  
220/665  
CPC ..... A61J 1/03; A61J 1/05; A47G 19/22;  
A47G 19/2205; A47G 19/2266; B65D 1/02;  
B65D 1/0223; B65D 1/08; B65D 1/10

See application file for complete search history.

(56) **References Cited**

U.S. PATENT DOCUMENTS

D75,191 S *	5/1928	Schafer .....	D7/605
D372,090 S *	7/1996	MacCauley et al. ....	D24/121
D426,161 S *	6/2000	Hestehave et al. ....	D9/520
D527,646 S *	9/2006	Cornet et al. ....	D9/560
D532,699 S *	11/2006	Mouquet .....	D9/694
D590,721 S *	4/2009	Martinez De San Vicente .....	D9/571
D614,036 S *	4/2010	Gedanke .....	D9/520
D655,612 S *	3/2012	Oge-Nichols .....	D9/559
D678,074 S *	3/2013	De France .....	D9/560
D682,704 S *	5/2013	Reynolds .....	D9/559
D691,484 S *	10/2013	Fitzgerald .....	D9/560
2011/0011874 A1 *	1/2011	Kurosawa .....	220/665
2012/0018440 A1 *	1/2012	Lane et al. ....	220/669

\* cited by examiner

*Primary Examiner* — Thomas Johannes  
*Assistant Examiner* — Catherine Posthauer  
(74) *Attorney, Agent, or Firm* — Michael J. Feigin, Esq.;  
Feigin & Associates, LLC

(57) **CLAIM**

The ornamental design for the rectangular perfume bottle, as shown and described.

**DESCRIPTION**

FIG. 1 shows a top perspective view of a rectangular perfume bottle.  
FIG. 2 shows a bottom perspective view thereof, the reverse view being a mirror thereof.  
FIG. 3 shows a side elevation view thereof, the reverse view being a mirror thereof.  
FIG. 4 shows a top plan view thereof; and,  
FIG. 5 shows a bottom plan view thereof.

**1 Claim, 5 Drawing Sheets**

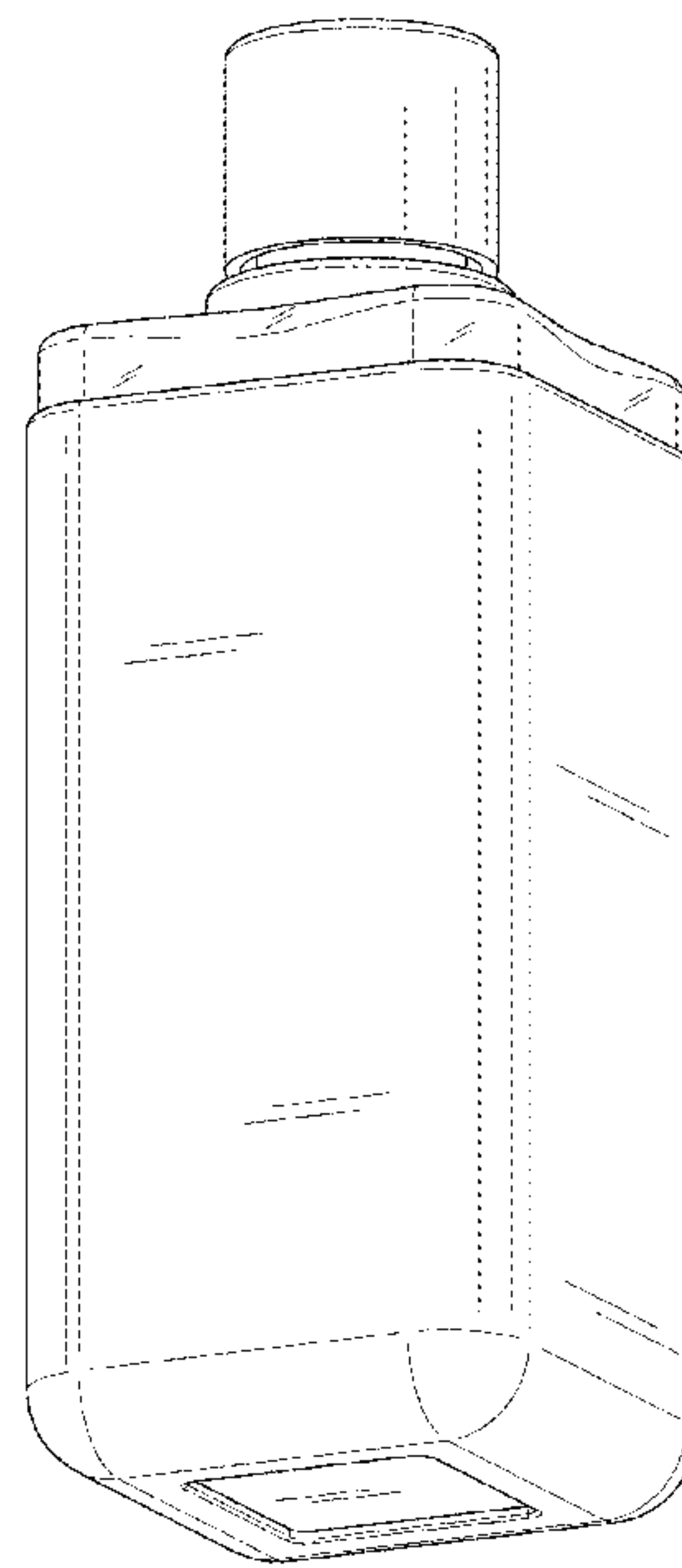
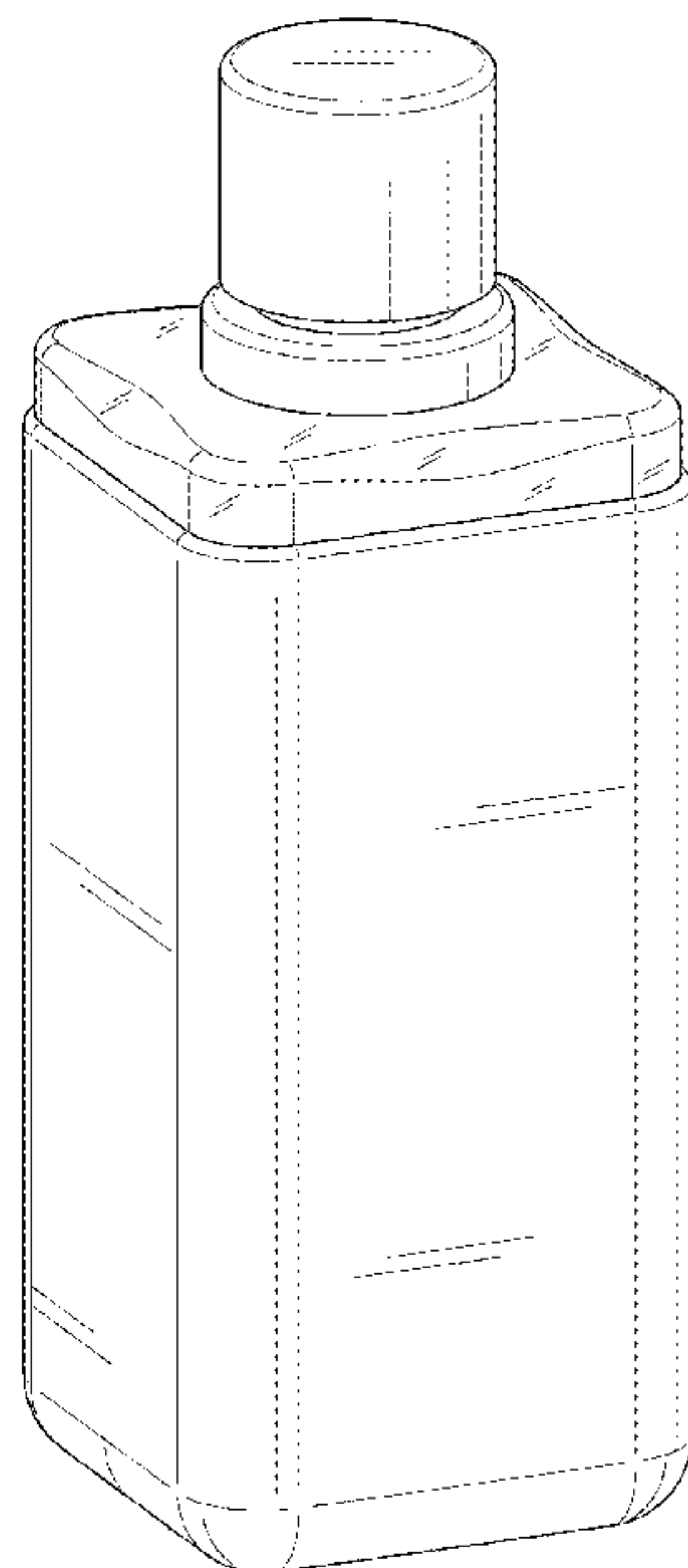

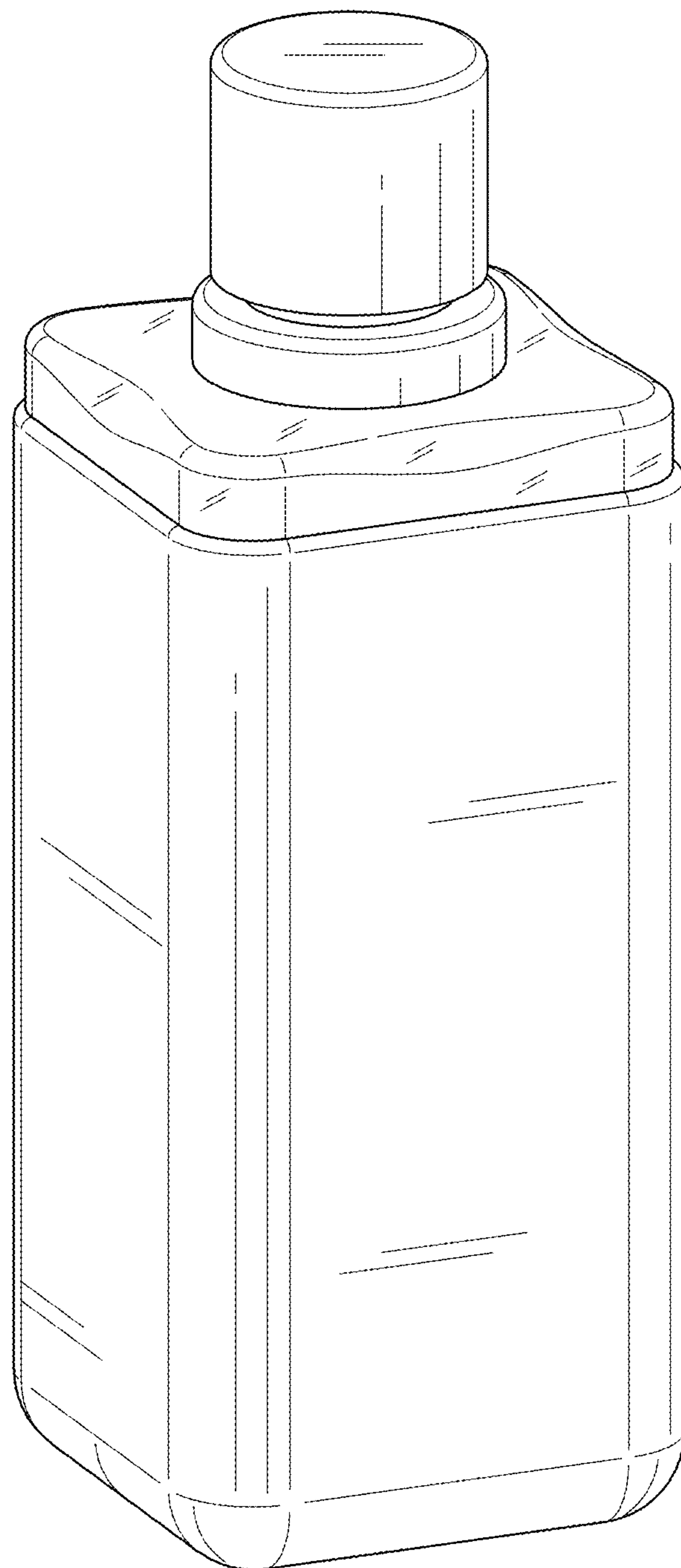

FIG. 1

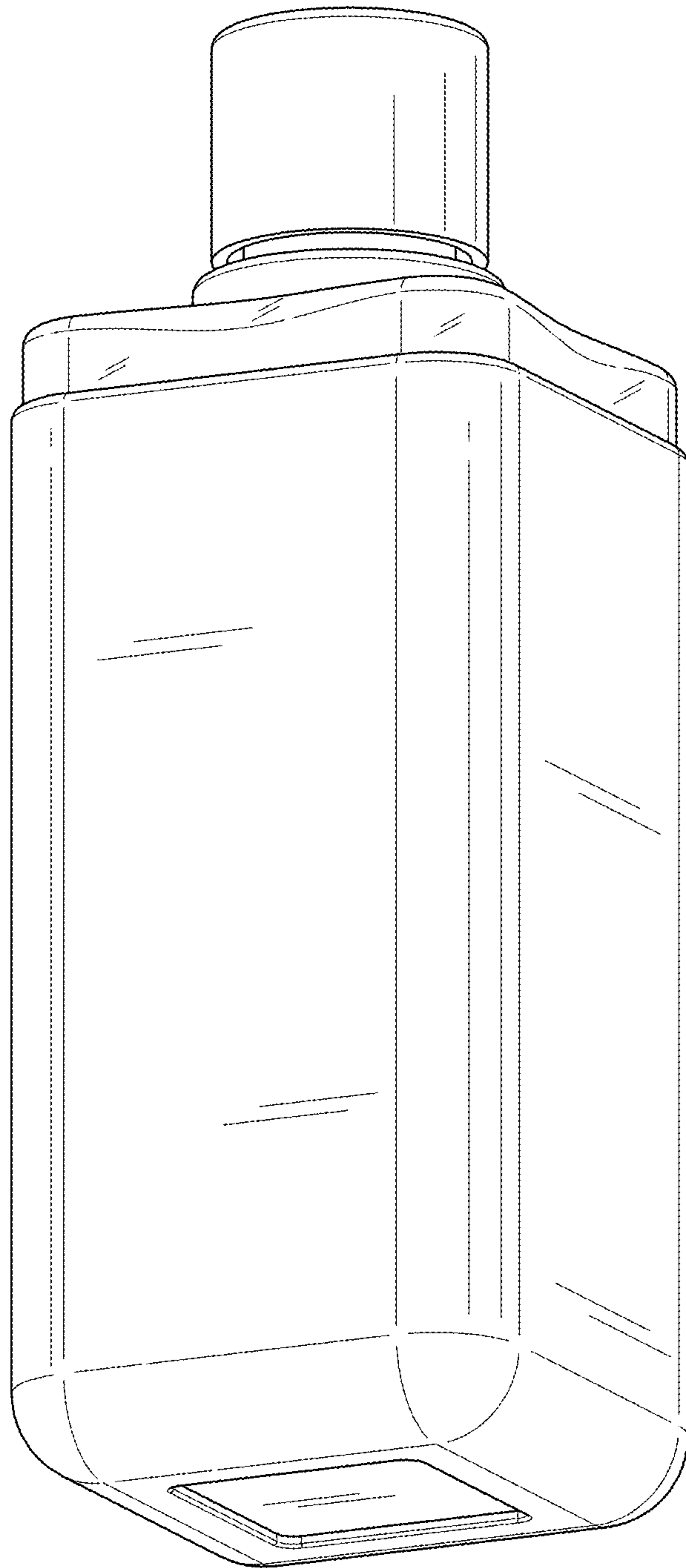

FIG. 2

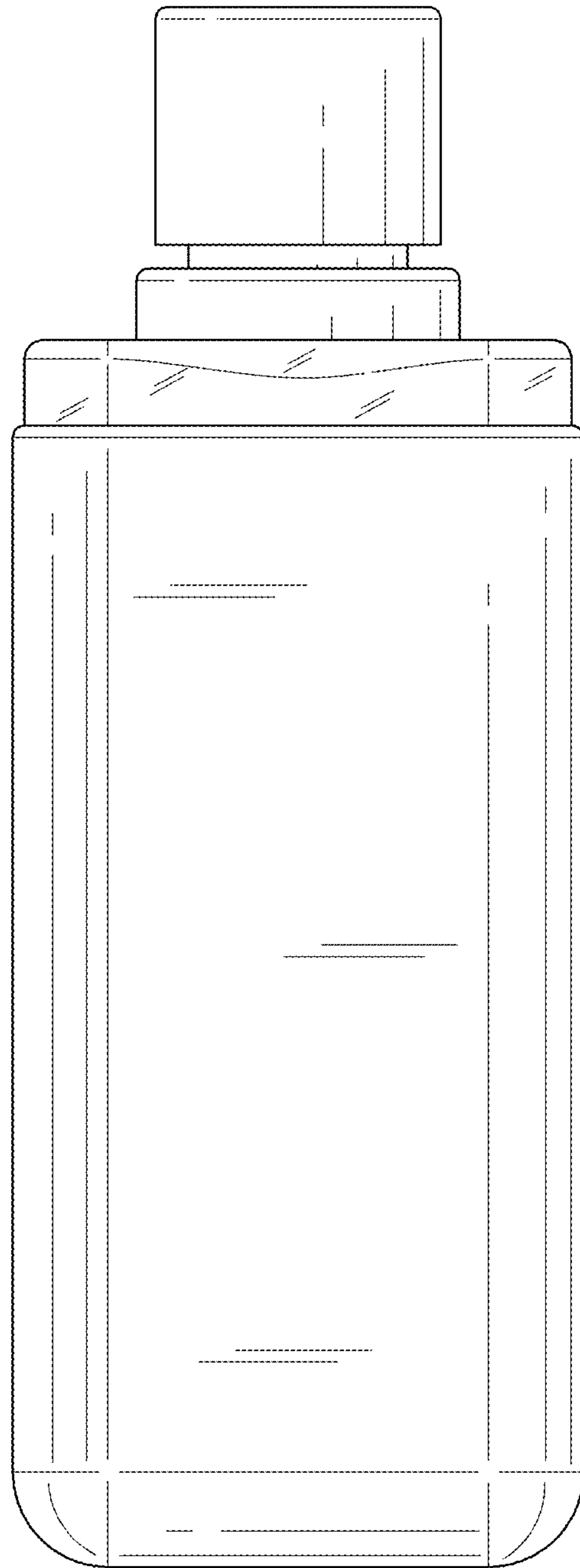

FIG. 3

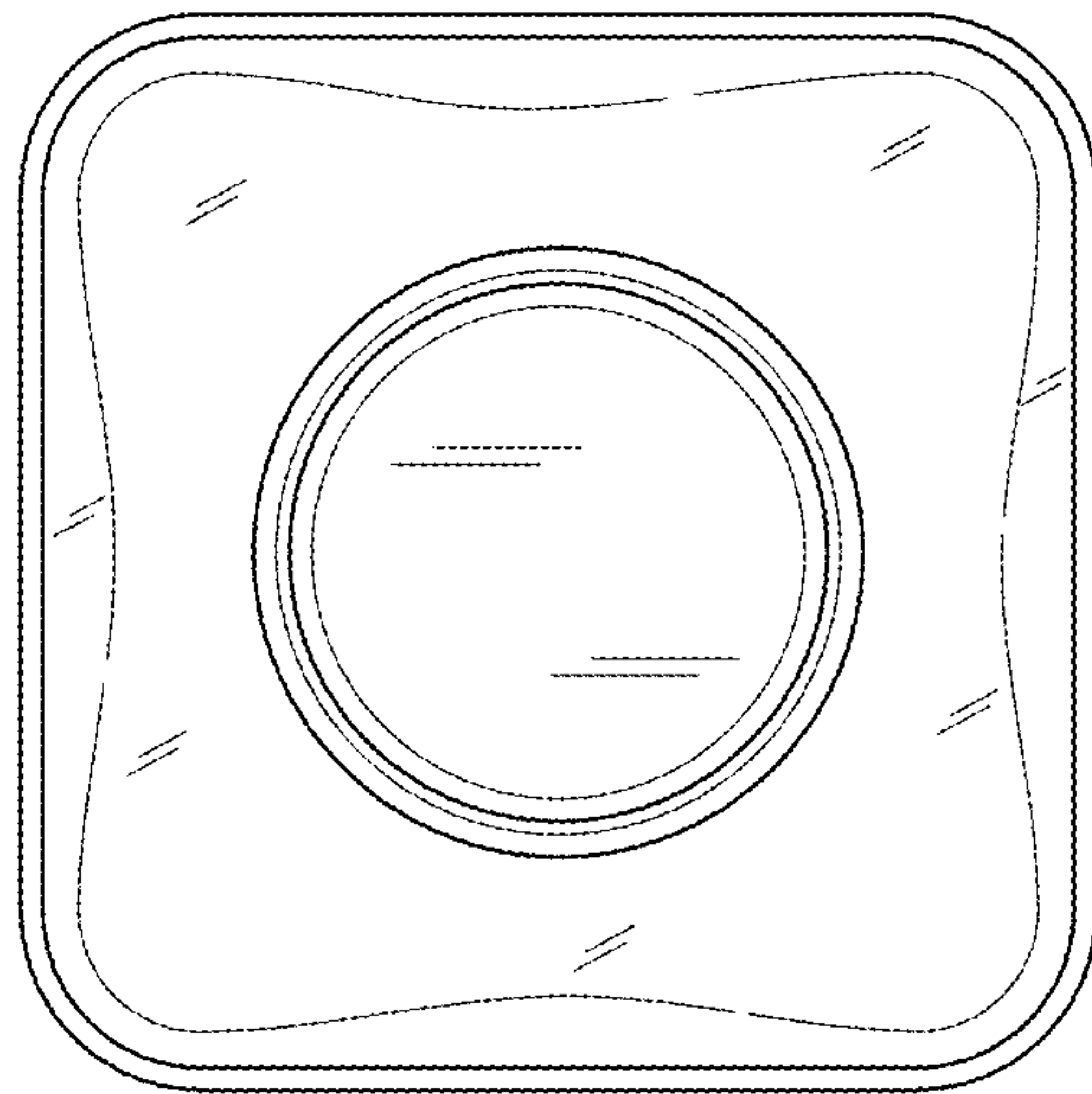

FIG. 4

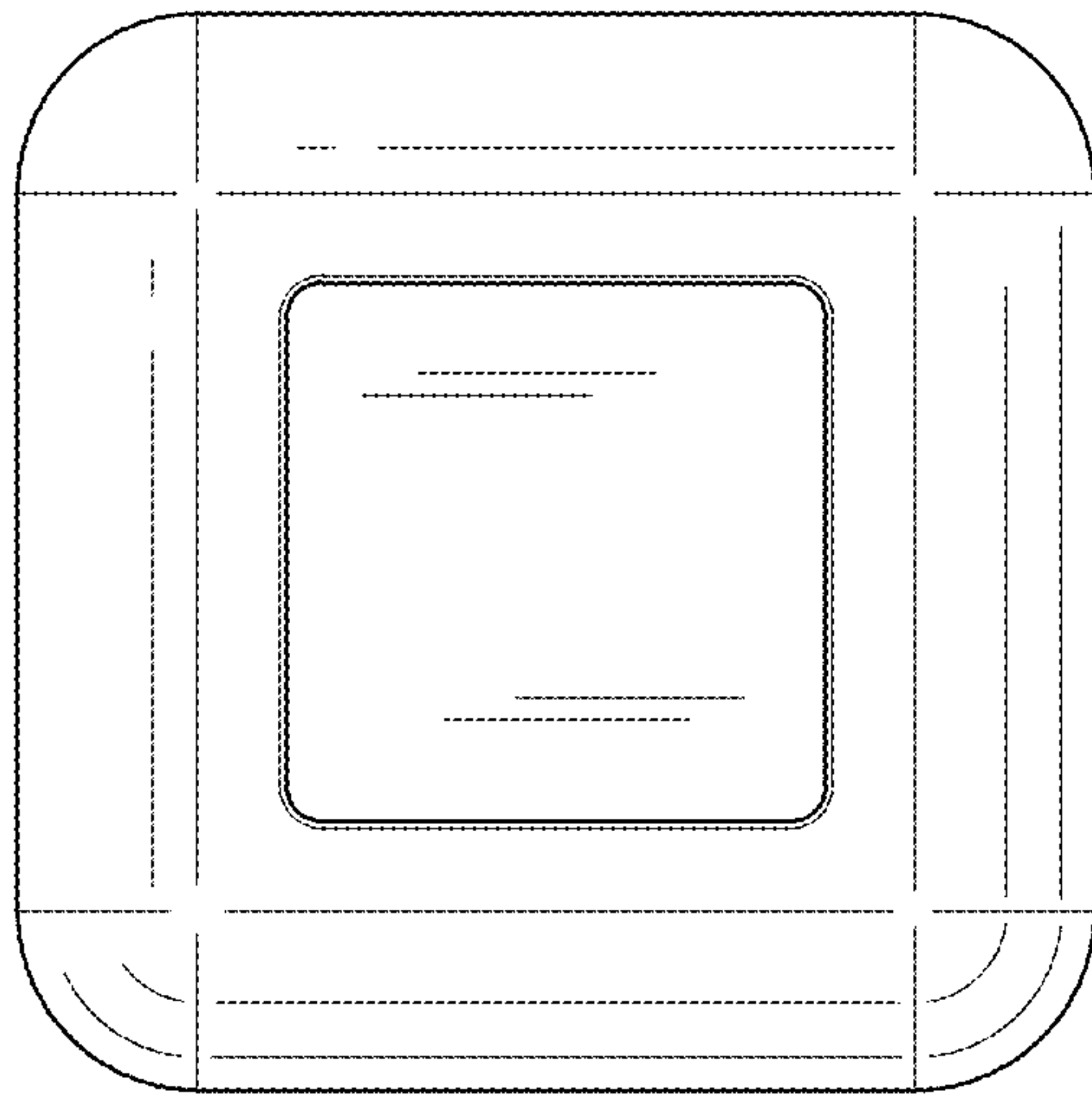

FIG. 5