



US00D741673S

(12) **United States Design Patent**  
**Seiders et al.**

(10) **Patent No.:** **US D741,673 S**

(45) **Date of Patent:** **\*\* Oct. 27, 2015**

- (54) **BOTTLE OPENER**
- (71) Applicant: **YETI Coolers, LLC**, Austin, TX (US)
- (72) Inventors: **Roy Joseph Seiders**, Austin, TX (US);  
**Erik Steven Larson**, Austin, TX (US)
- (73) Assignee: **YETI Coolers, LLC**, Austin, TX (US)
- (\*\*) Term: **14 Years**
- (21) Appl. No.: **29/513,208**
- (22) Filed: **Dec. 29, 2014**
- (51) **LOC (10) Cl.** ..... **07-99**
- (52) **U.S. Cl.**  
USPC ..... **D8/33**
- (58) **Field of Classification Search**  
USPC ..... D8/16, 18, 19, 33-43, 89, 98-104, 396,  
D8/105; D7/649, 650; 30/294  
CPC ..... B67B 7/00; B67B 7/14; B67B 7/16;  
B67B 7/24; B67B 7/30; B67B 7/32; B67B  
7/34; B67B 7/36; B67B 7/38; B67B 7/44  
See application file for complete search history.

D306,394	S	*	3/1990	Koenig	.....	D8/102
5,127,162	A	*	7/1992	Mansfield	.....	30/294
D329,584	S	*	9/1992	Shevin et al.	.....	D8/102
5,524,348	A	*	6/1996	Tipp	.....	30/294
D380,365	S	*	7/1997	Schmidt	.....	D8/102
5,815,930	A	*	10/1998	Kojima	.....	30/294
7,527,235	B2	*	5/2009	Hummel	.....	248/459

\* cited by examiner

*Primary Examiner* — Elizabeth Albert

(74) *Attorney, Agent, or Firm* — Banner & Witcoff, Ltd.

(57) **CLAIM**

The ornamental design for a bottle opener, as shown and described.

**DESCRIPTION**

FIG. 1 is a top, front, left perspective view of a bottle opener showing our new design;  
 FIG. 2 is a front view thereof;  
 FIG. 3 is a rear view thereof;  
 FIG. 4 is a right side view thereof;  
 FIG. 5 is a left side view thereof;  
 FIG. 6 is a top view thereof; and,  
 FIG. 7 is a bottom view thereof.

The long and short broken lines in FIGS. 1 to 7 that define the bounds of the claimed design form no part thereof.

The portions of the bottle opener and indicia in evenly spaced broken lines in the drawings in FIGS. 1 to 7 are shown for environmental purposes only and form no part of the claimed design.

**1 Claim, 3 Drawing Sheets**

(56) **References Cited**

**U.S. PATENT DOCUMENTS**

D25,563	S	*	6/1896	Mueller	.....	D8/383
1,920,520	A	*	8/1933	Nord	.....	248/48.2
2,616,099	A	*	11/1952	Silvio	.....	5/207
4,025,019	A	*	5/1977	Jacobsen et al.	.....	248/317
4,062,117	A	*	12/1977	Coleman	.....	30/317
D300,549	S	*	4/1989	Crow	.....	D22/108

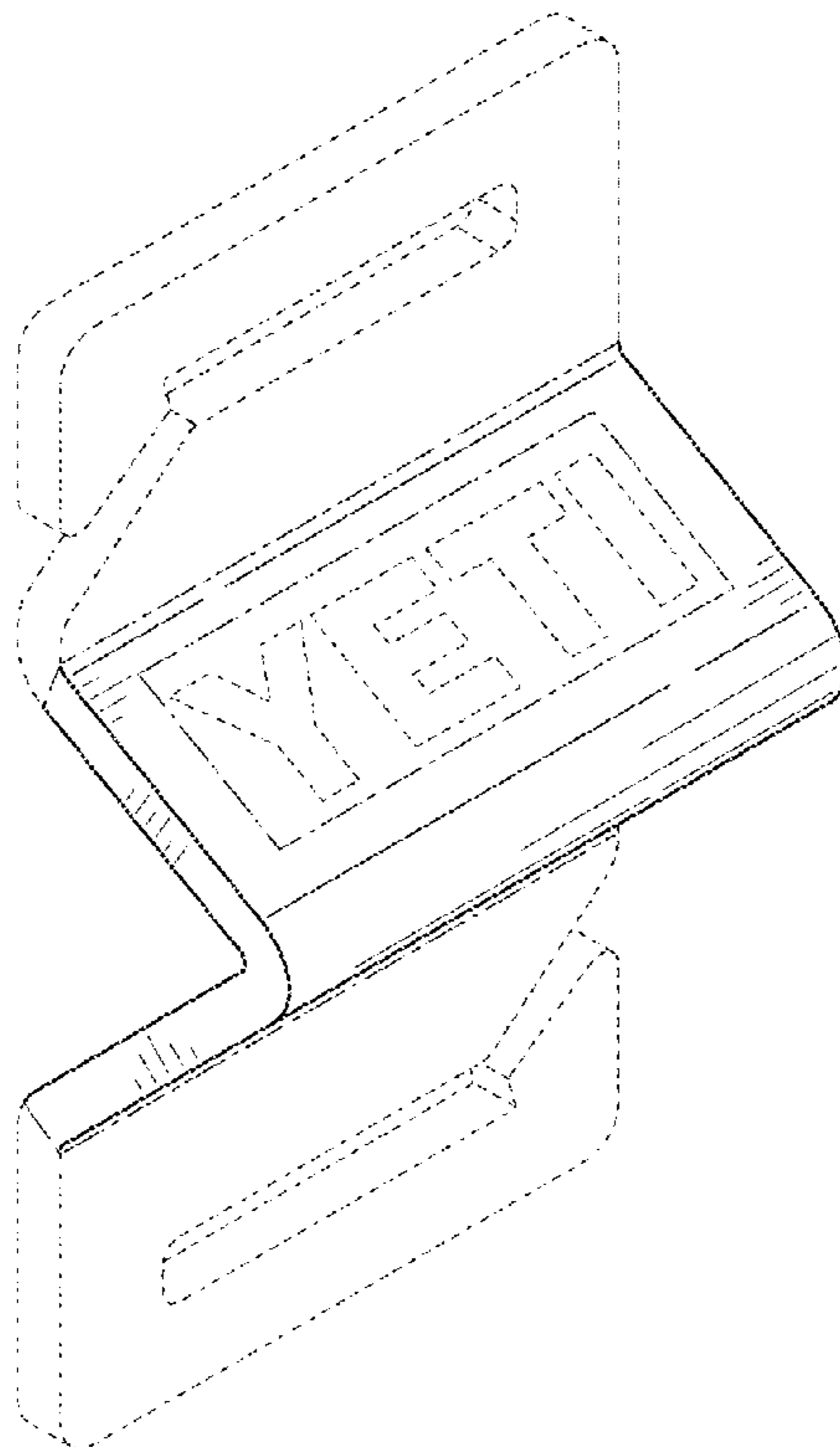

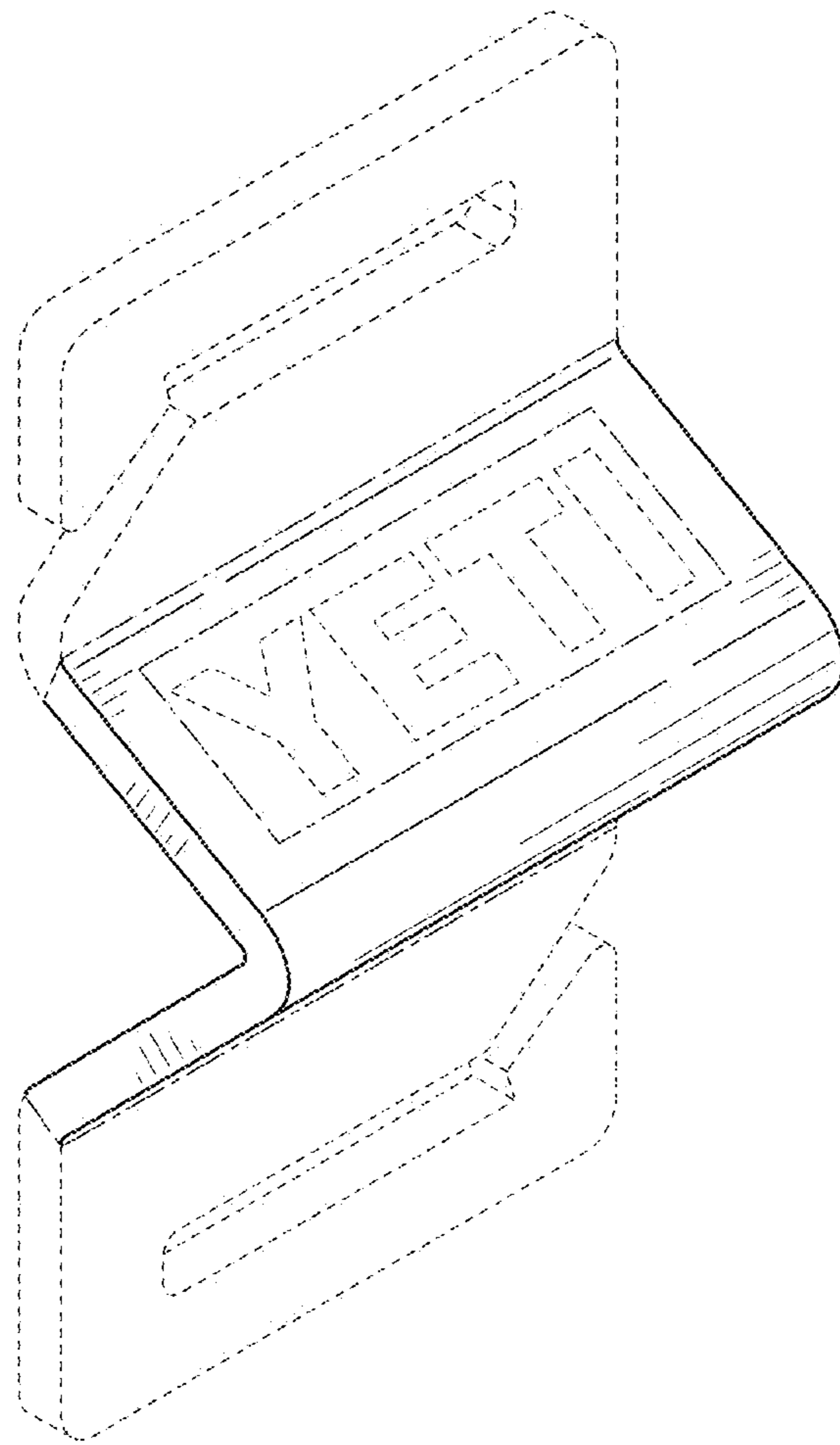

FIG. 1

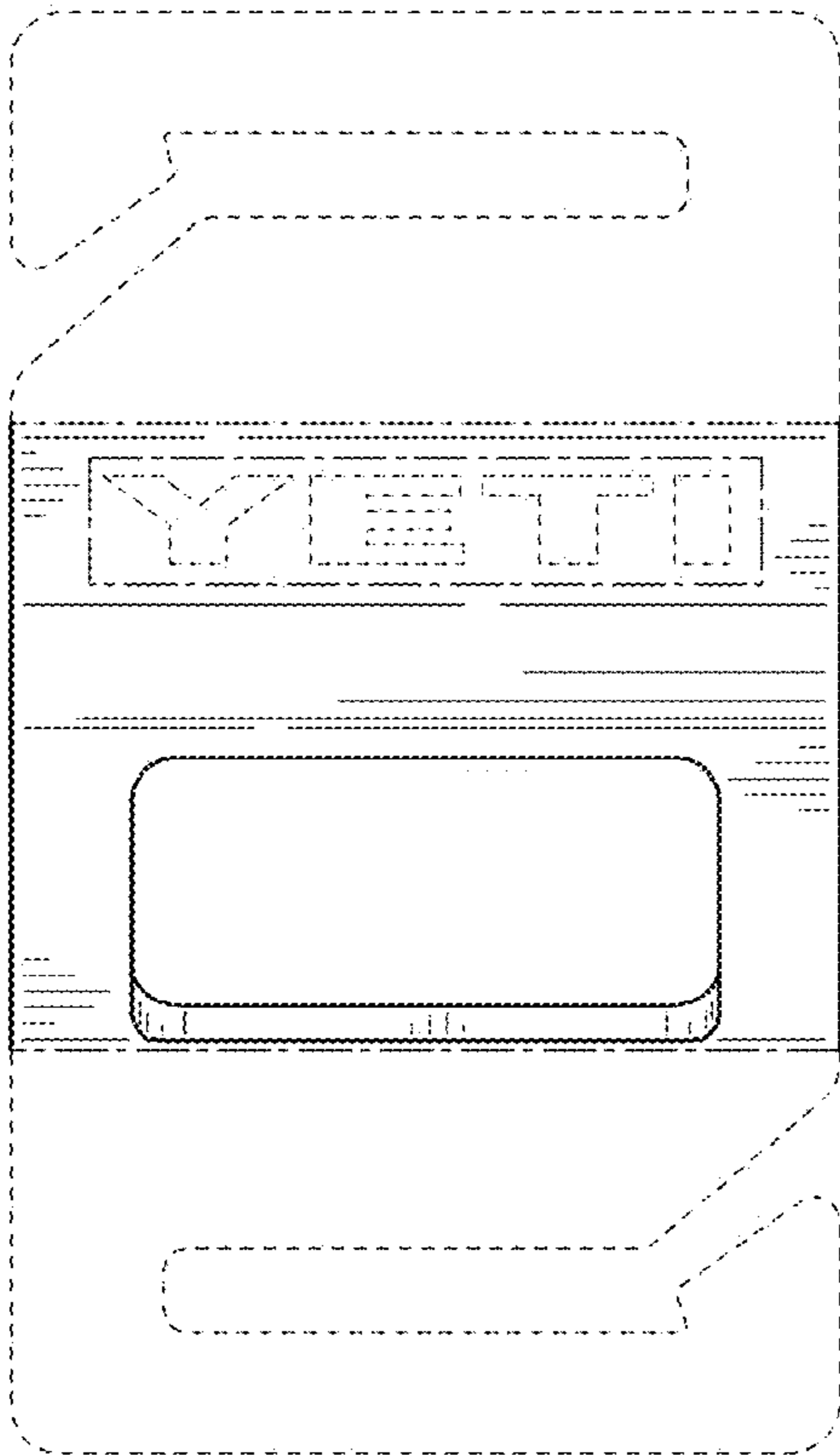

FIG. 2

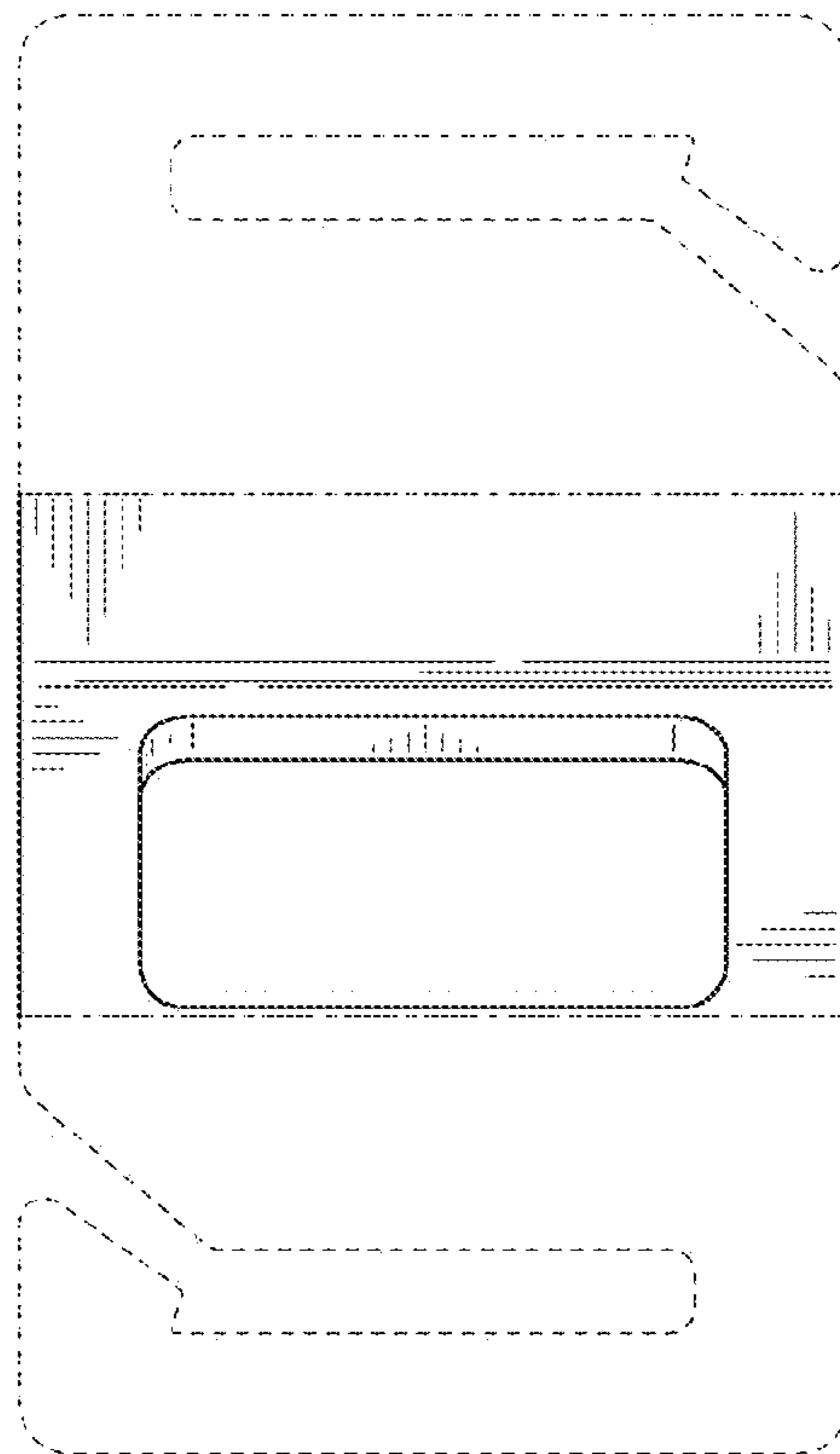

FIG. 3

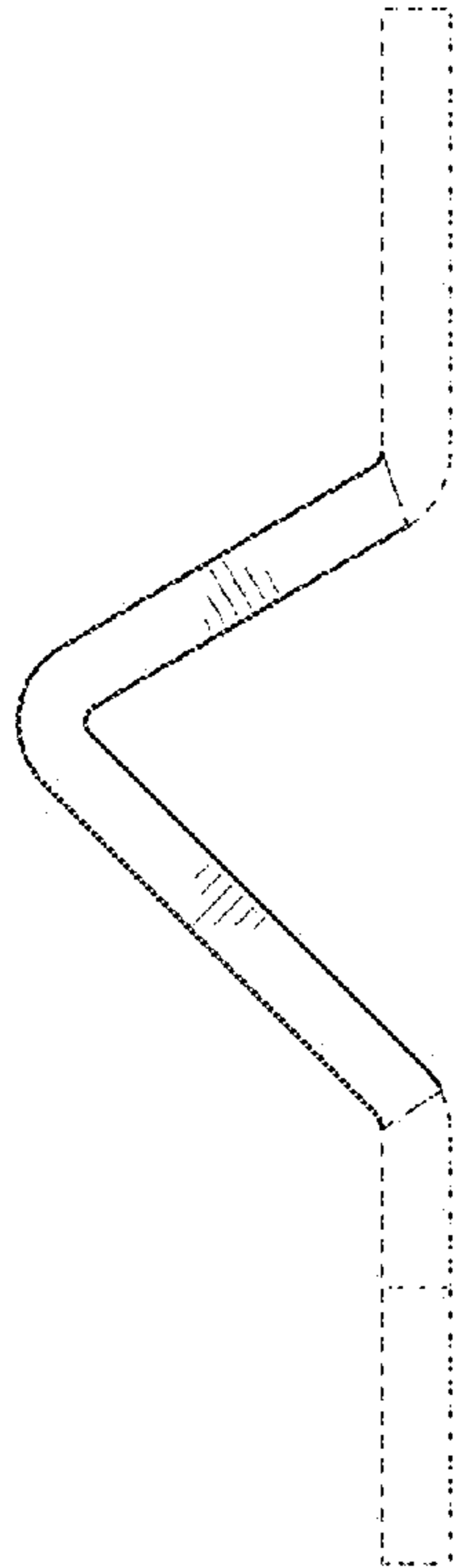

FIG. 4

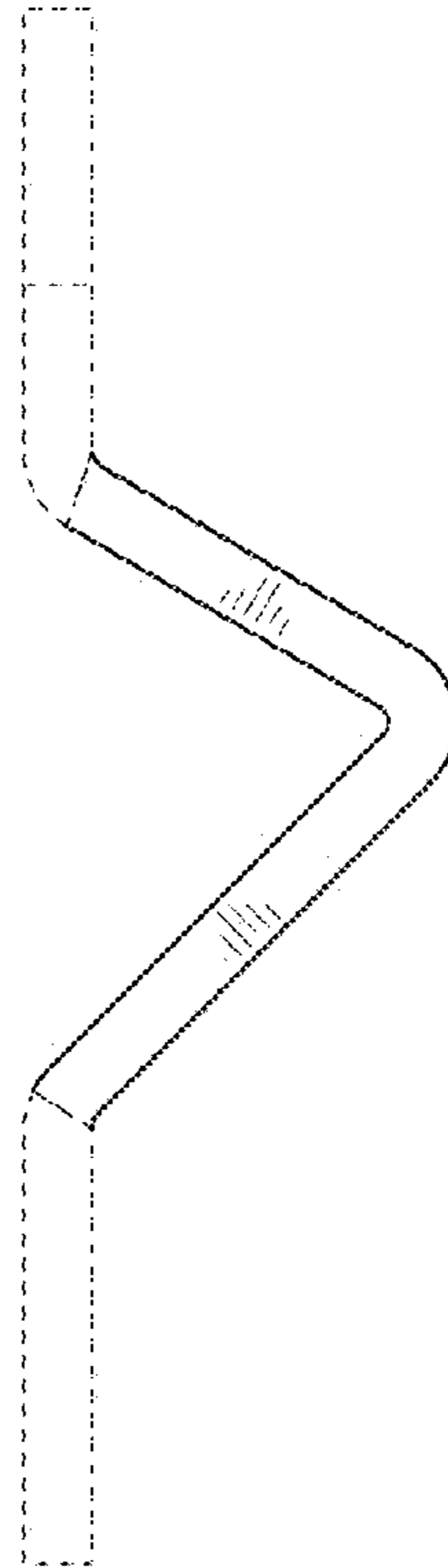

FIG. 5

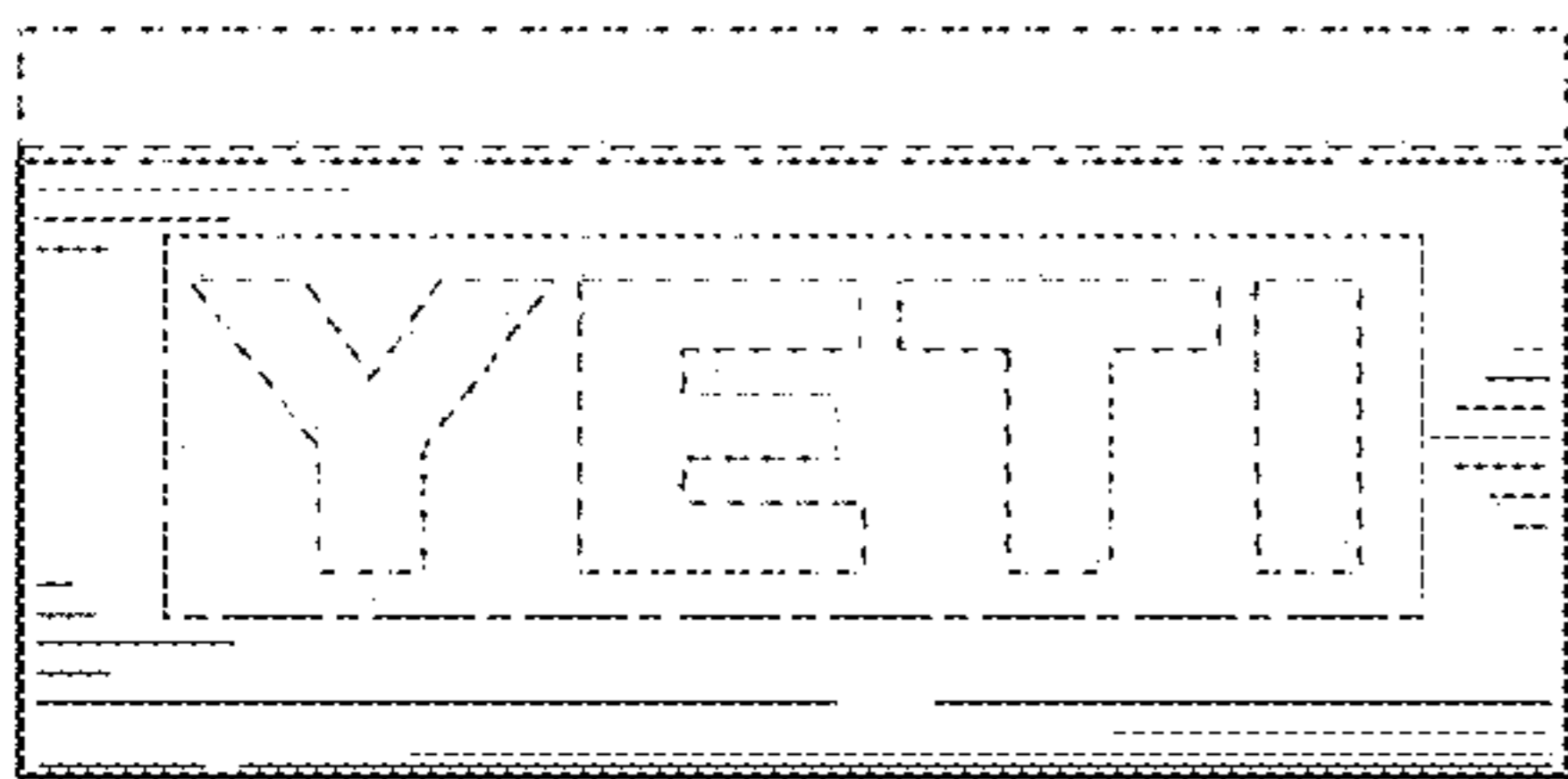

FIG. 6

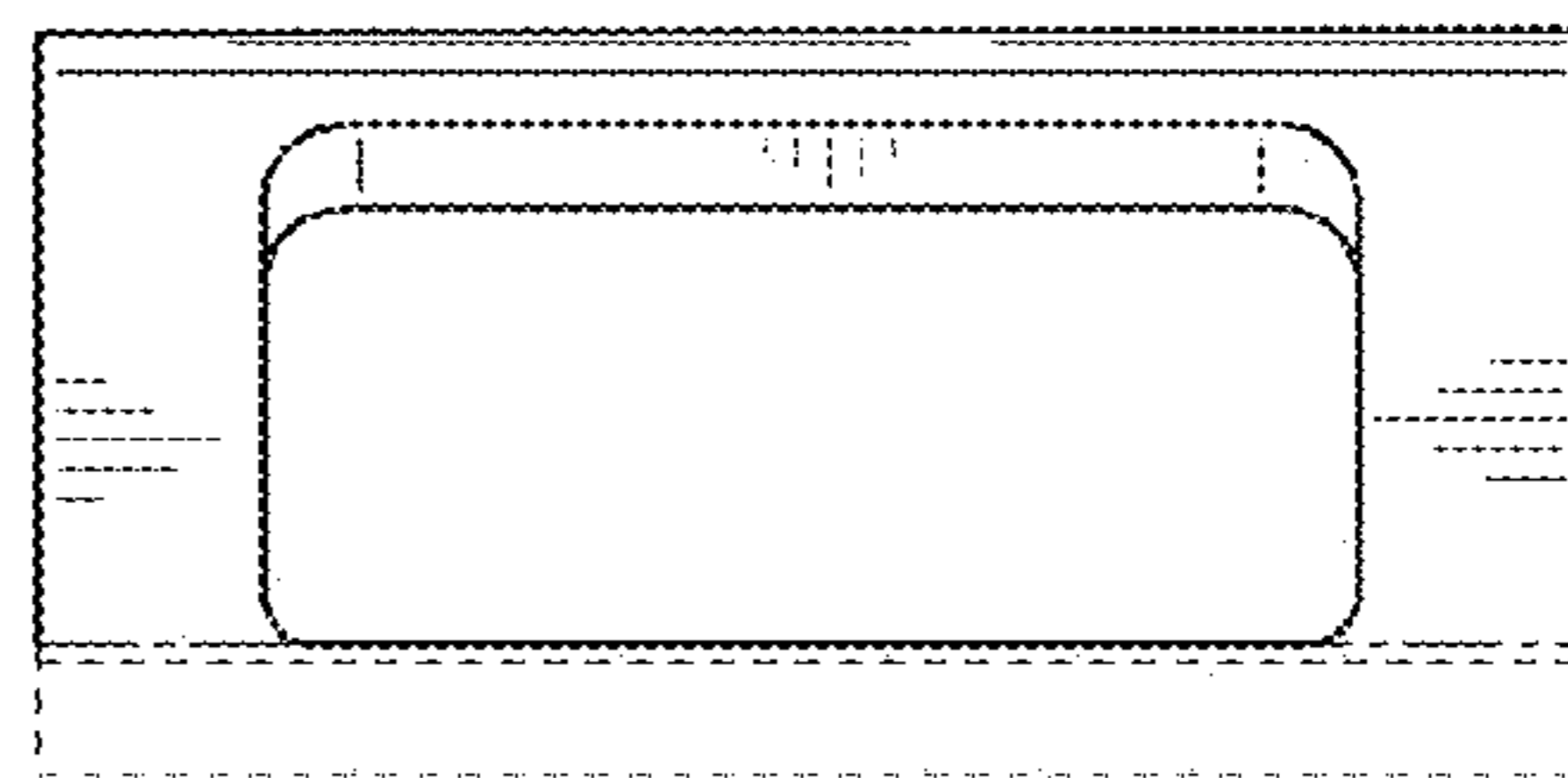

FIG. 7