



US00D741603S

(12) **United States Design Patent**
Mehta et al.

(10) **Patent No.:** **US D741,603 S**
(45) **Date of Patent:** **** Oct. 27, 2015**

(54) **CONTAINER FOR A COSMETIC PRODUCT**

(71) Applicant: **Je Matadi, Inc.**, Stafford, TX (US)

(72) Inventors: **Pershant Mehta**, Stafford, TX (US);
Leo Chieh-Hao Chen, Stafford, TX (US)

(73) Assignee: **JE MATADI, Inc.**, Stafford, TX (US)

(**) Term: **14 Years**

(21) Appl. No.: **29/462,529**

(22) Filed: **Aug. 5, 2013**

(51) **LOC (10) Cl.** **09-01**

(52) **U.S. Cl.**
USPC **D4/116; D9/504**

(58) **Field of Classification Search**
USPC D4/116, 121, 135; D9/436, 454, 500,
D9/503, 504, 516, 520, 549, 558, 574, 723,
D9/725; D28/76, 77; 206/15.2, 15.3, 581,
206/823; 215/227, 228; 401/121, 122, 126,
401/127, 129
CPC A45D 29/00; A45D 29/007; A45D 29/11;
A45D 29/12; A45D 34/00; A45D 34/042;
A45D 34/045; A45D 2034/00; A45D
2034/002; A45D 2200/10; A45D 2200/1009;
A45D 2200/1018; B65D 51/32
See application file for complete search history.

(56) **References Cited**

U.S. PATENT DOCUMENTS

4,219,283 A * 8/1980 Buckley et al. 401/129
5,116,154 A * 5/1992 Fulkerson 401/127
D555,835 S * 11/2007 Song D28/76
7,448,393 B2 * 11/2008 Beak 132/218
8,083,092 B2 12/2011 Hartstock
8,083,427 B2 12/2011 Maddy
D651,515 S 1/2012 Haile
D651,521 S 1/2012 Haile
D656,824 S 4/2012 Haile

D659,004 S * 5/2012 McCoy D9/529
D685,638 S * 7/2013 DeMarco D9/504
2011/0120907 A1 5/2011 Haile

FOREIGN PATENT DOCUMENTS

DE 202012005980 U1 * 12/2012
JP 2005349106 A * 12/2005

OTHER PUBLICATIONS

GB 2076969 Registeredl Design (Yvonne E. Martin) May 11, 2000,
[online], [retrieved on Jul. 8, 2015] Retrieved from the Design Data-
base of the Intellectual Property Office of the United Kingdom using
the Internet: <URL: http://www.ipo.gov.uk>.*

* cited by examiner

Primary Examiner — Melanie H Tung
Assistant Examiner — Lavone D Tabor

(74) *Attorney, Agent, or Firm* — Andrew W. Chu; Craft Chu
PLLC

(57) **CLAIM**

The ornamental design for a container for a cosmetic product,
as shown and described.

DESCRIPTION

FIG. 1 is an upper perspective view of the container for a
cosmetic product showing our design.
FIG. 2 is a front elevation view thereof;
FIG. 3 is a back elevation view thereof;
FIG. 4 is a side elevation view thereof;
FIG. 5 is an opposite side elevation view thereof;
FIG. 6 is a top plan view thereof;
FIG. 7 is a bottom plan view thereof;
FIG. 8 is an exploded upper perspective view thereof, show-
ing components of the container; and,
FIG. 9 is an exploded bottom perspective view thereof, show-
ing components of the container from a different angle.

1 Claim, 2 Drawing Sheets

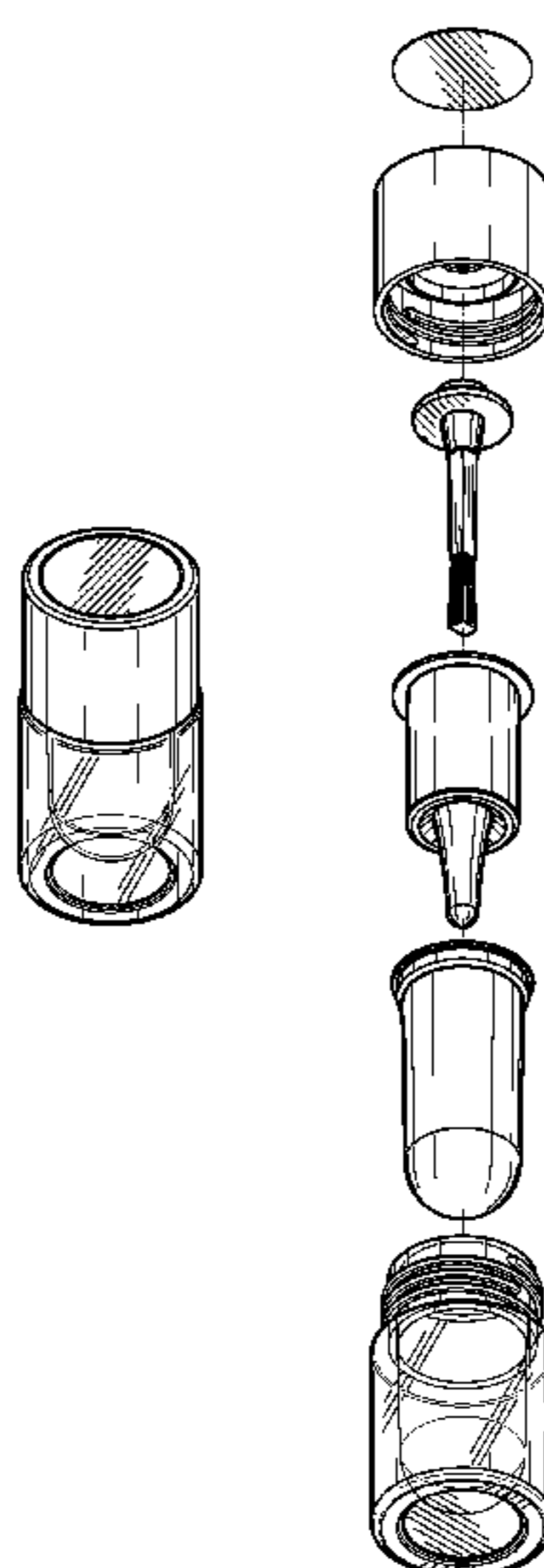

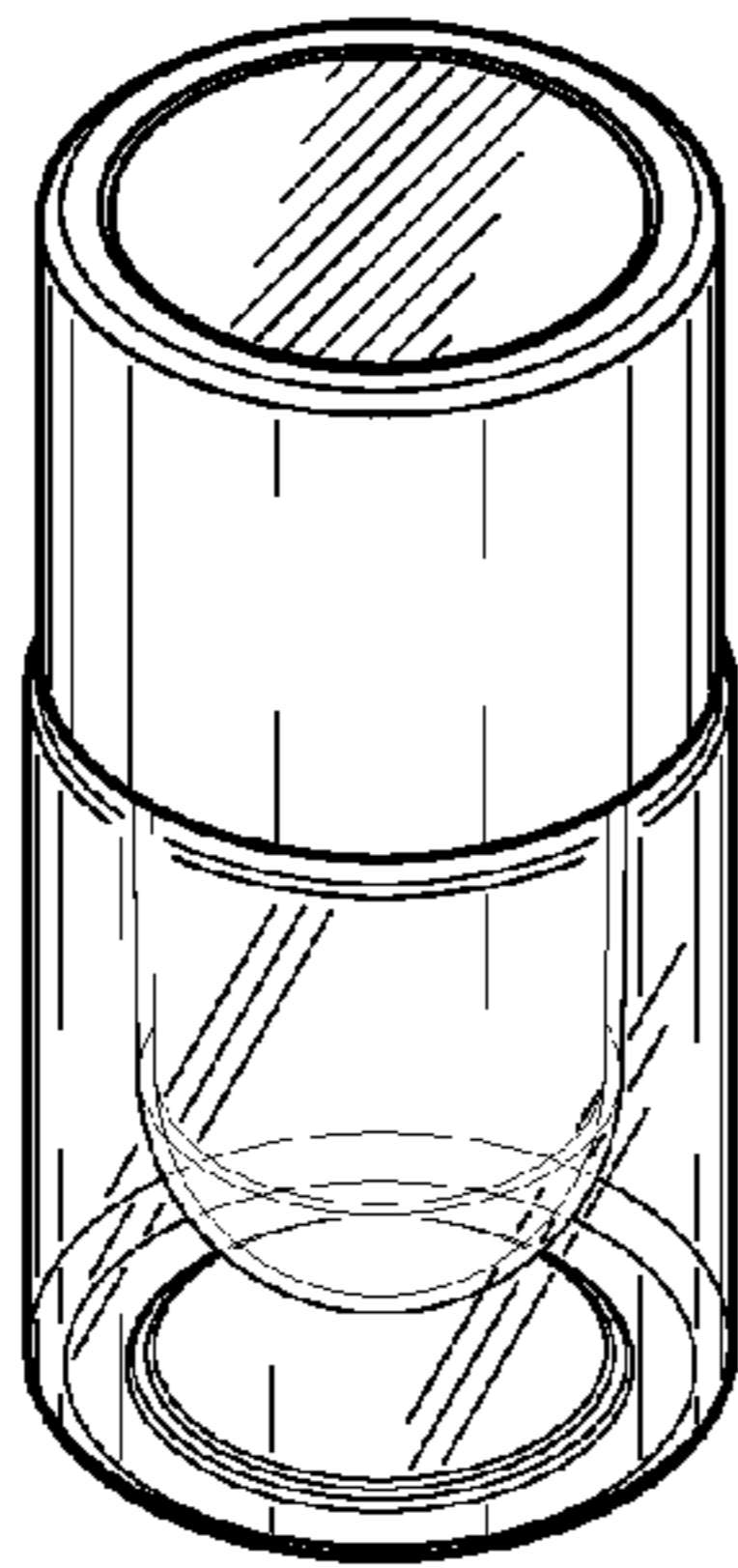

FIG. 1

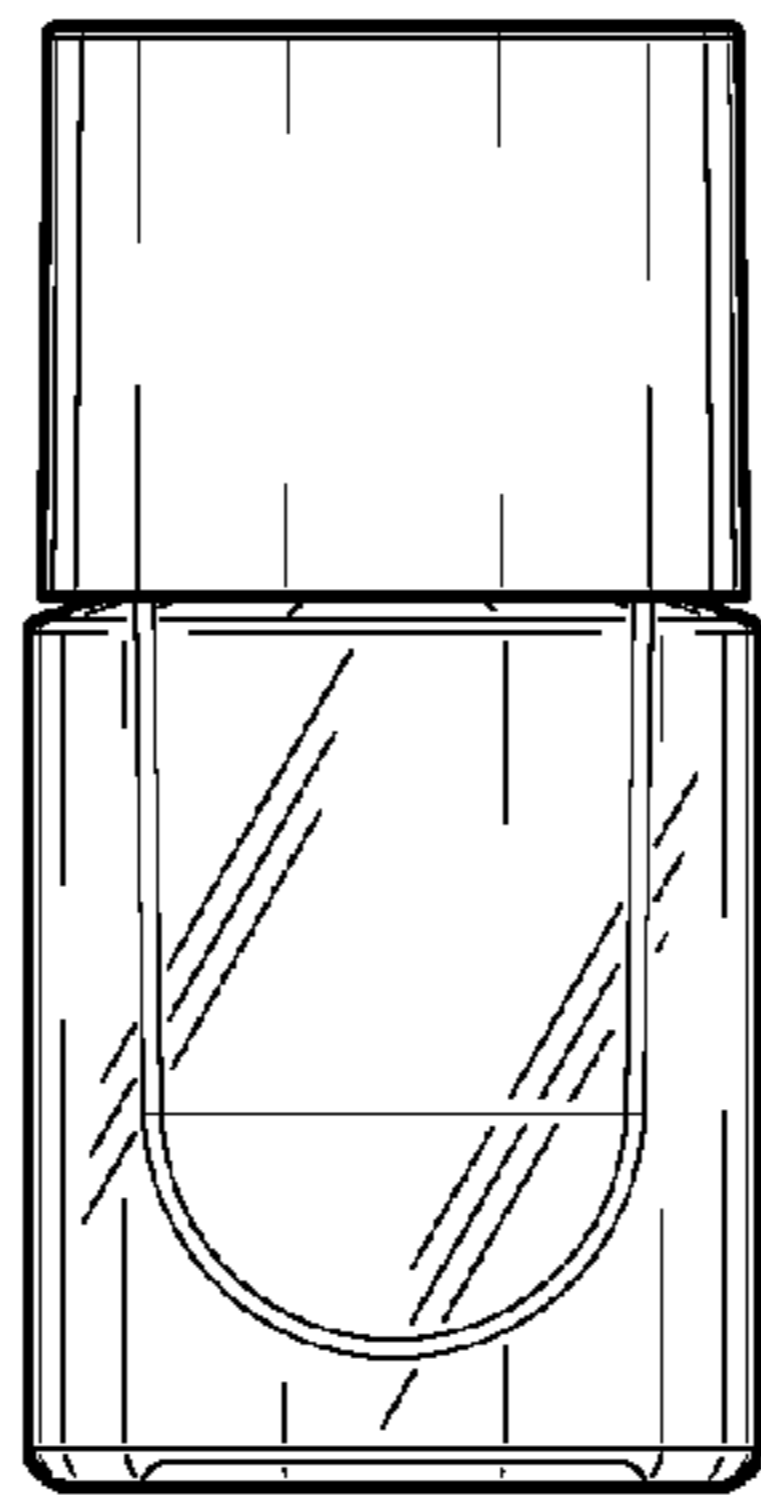

FIG. 2

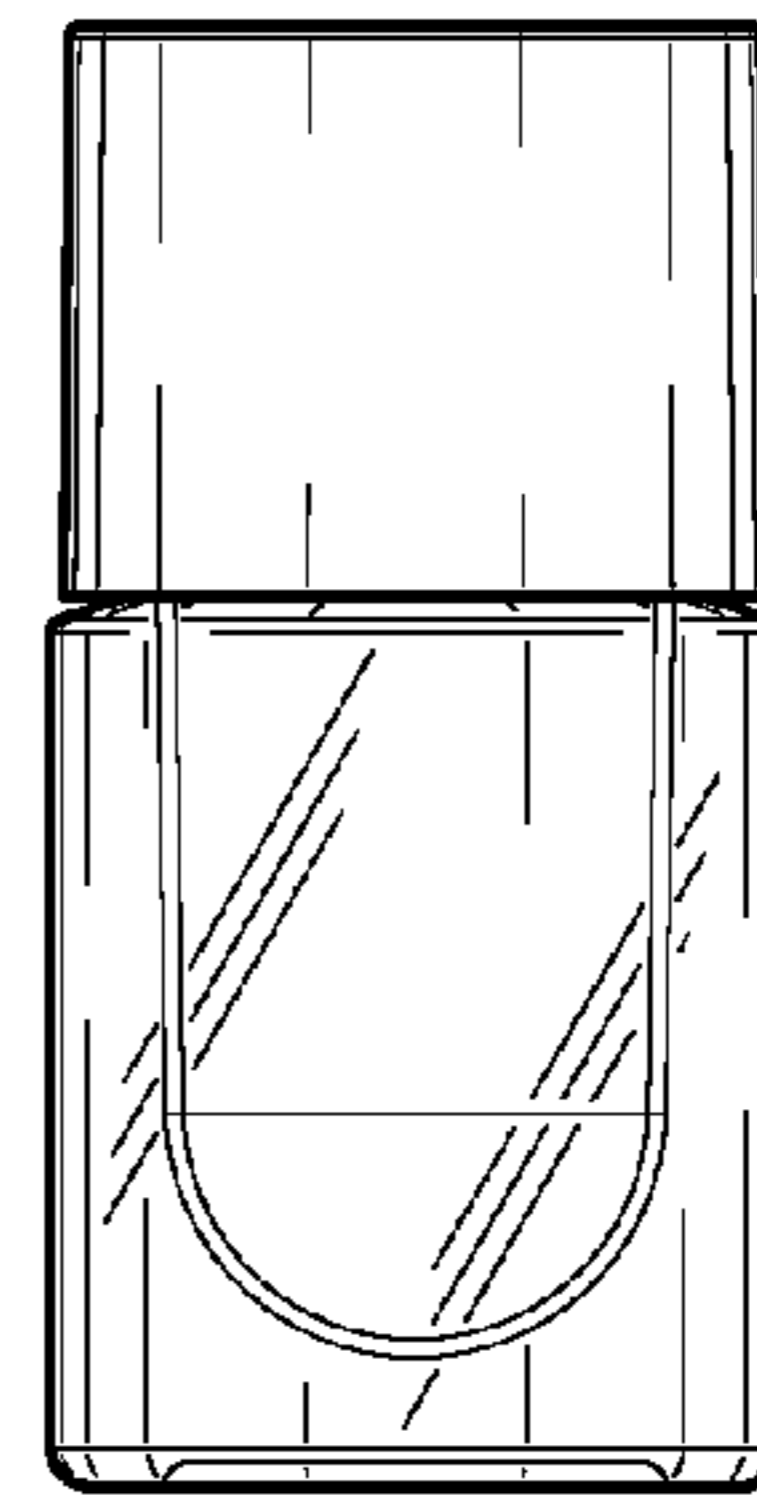

FIG. 3

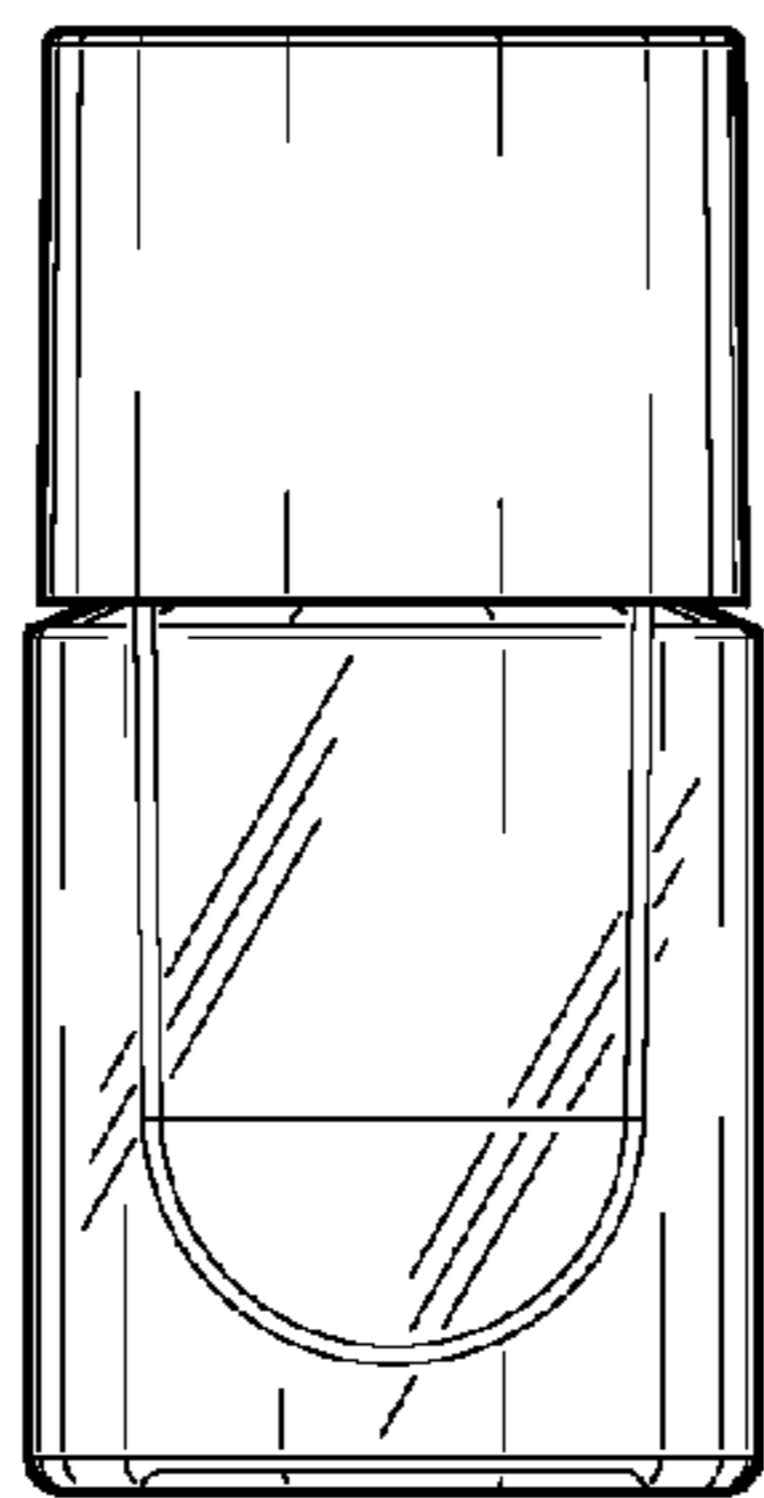

FIG. 4

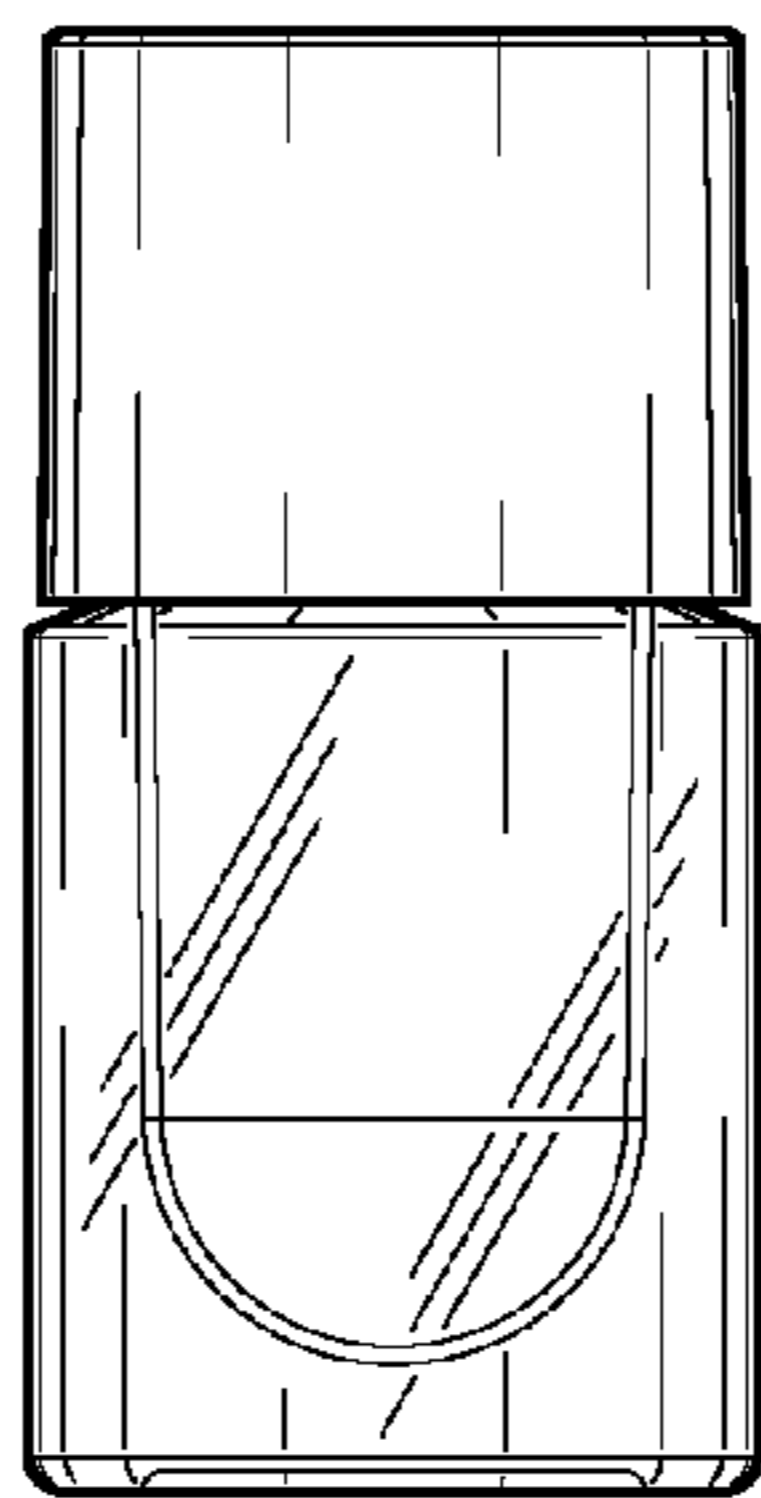

FIG. 5

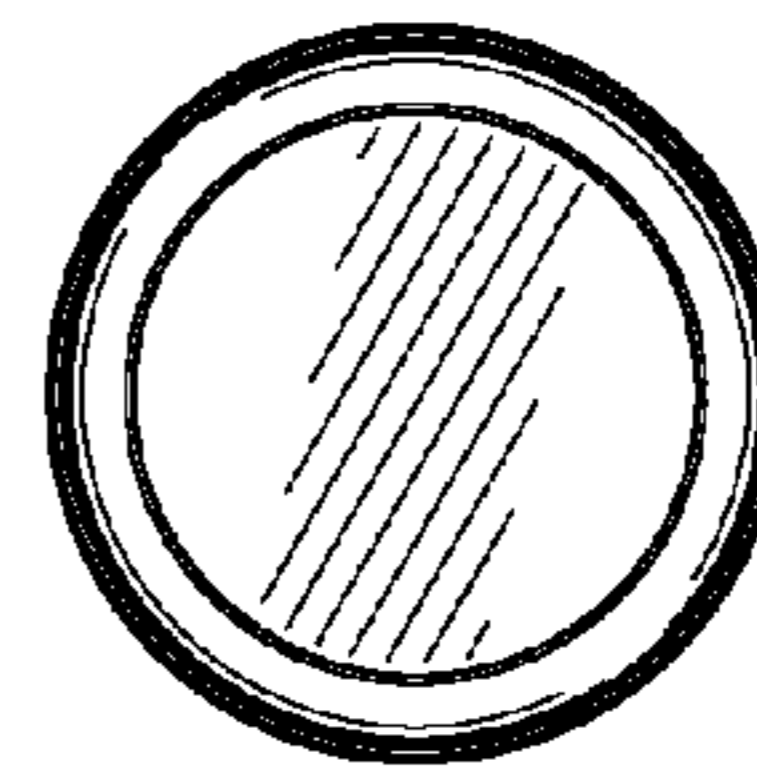

FIG. 6

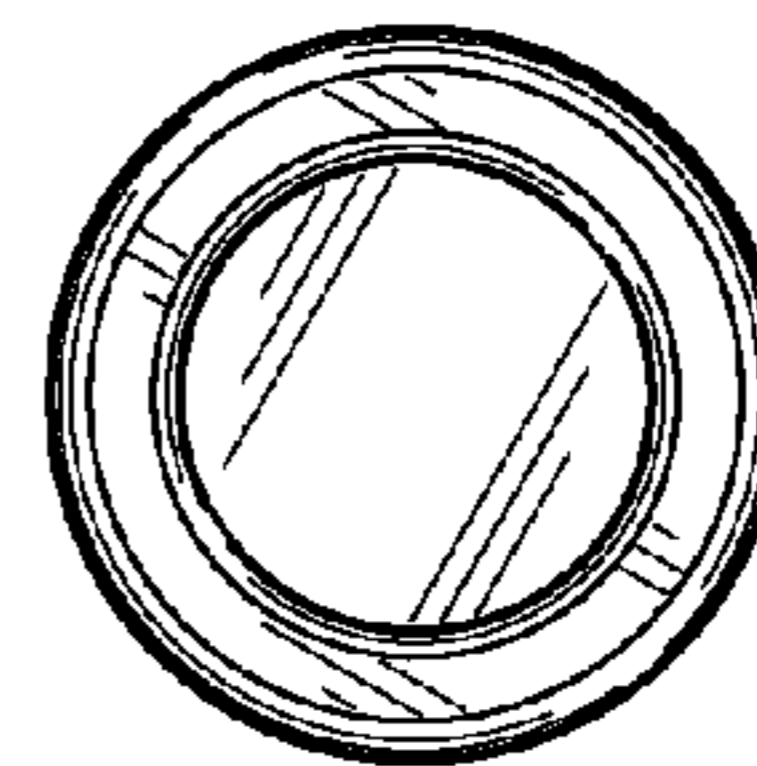

FIG. 7

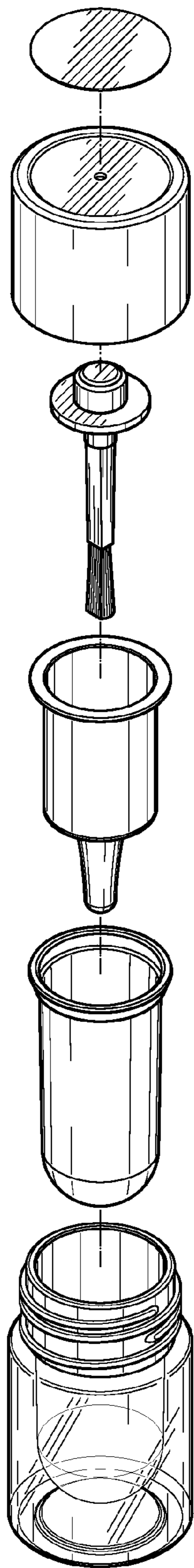

FIG. 8

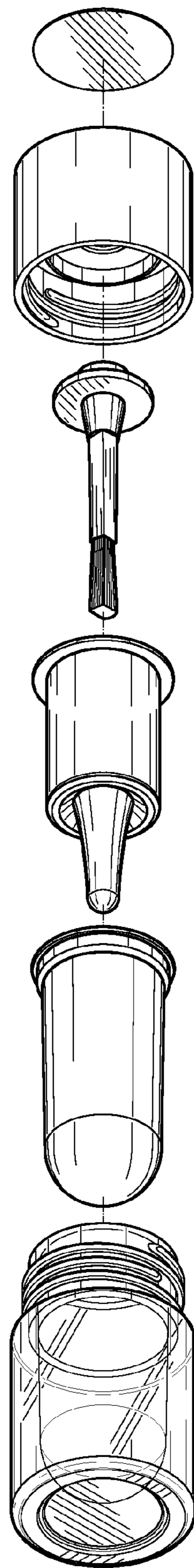

FIG. 9