



US00D741568S

(12) **United States Design Patent**
Daugherty et al.

(10) **Patent No.:** **US D741,568 S**
(45) **Date of Patent:** **** Oct. 27, 2015**

(54) **SWADDLE BLANKET**

- (71) Applicant: **Triboro Quilt Manufacturing Corp.**,
White Plains, NY (US)
- (72) Inventors: **Jonathan Daugherty**, Dayton, OH (US);
Richard White, Dayton, OH (US)
- (73) Assignee: **TRIBORO QUILT**
MANUFACTURING CORP., White
Plains, NY (US)
- (**) Term: **14 Years**

- (21) Appl. No.: **29/450,007**
- (22) Filed: **Mar. 15, 2013**
- (51) **LOC (10) Cl.** **02-02**
- (52) **U.S. Cl.**
USPC **D2/719**
- (58) **Field of Classification Search**
USPC 2/69.5, 75; 5/413 R, 482, 485, 486, 487,
5/488, 496, 501; D2/717-720, 724, 728,
D2/739, 745, 746, 750, 751, 755, 823, 824,
D2/828, 831, 840-842, 844, 846, 850,
D2/860-862; D6/610, 611, 602, 603, 615,
D6/621
CPC A41B 13/06; A41B 13/08; A47G 9/083
See application file for complete search history.

(56) **References Cited**

U.S. PATENT DOCUMENTS

429,894 A 6/1890 Doremus
648,621 A 5/1900 Hooper et al.

(Continued)

FOREIGN PATENT DOCUMENTS

CN 301001990 * 9/2009
DE 202011004399 U1 * 8/2011 A41B 13/06

(Continued)

OTHER PUBLICATIONS

Miracle Blanket. <URL: <http://www.miracleblanket.com/>>. Oct. 11, 2012. Swaddle with inner flaps.*

Primary Examiner — Bridget L Eland
Assistant Examiner — Lauren McVey
(74) *Attorney, Agent, or Firm* — Leason Ellis LLP

(57) **CLAIM**

The ornamental design for a swaddle blanket, as shown and described.

DESCRIPTION

FIG. 1 is a front elevation view of a swaddle blanket showing my new design wherein the outer portion is shown in an open position and the inner portion is shown in a closed position; FIG. 2 is a rear elevation view thereof; FIG. 3 is a front elevation view thereof shown in an environment wherein the inner and outer portions are shown in the open position; FIG. 4 is a front elevation view thereof shown in an environment wherein the outer portion is shown in an open position and the inner portion is shown in a closed position; FIG. 5 is a front elevation view thereof shown in an environment wherein the right wing portion is in the closed position; FIG. 6 is a front elevation view thereof shown in an environment wherein the left wing portion is in a closed position and overlapping the right wing portion; FIG. 7 is a front elevation view thereof shown in an environment in the closed position wherein the with a bottom portion is in an open position; FIG. 8 is a right side view thereof shown in an environment in the closed position wherein the bottom portion is in the open position; and, FIG. 9 is a left side view thereof shown in an environment in the closed position wherein the bottom portion is in the open position.

The pattern sporadically depicted throughout the views is intended to indicate that the pattern is continuous throughout the surface on which the pattern is shown.

The long dash broken lines and the dot-dash broken lines are directed to environment; the broken lines form no part of the claimed design. The evenly spaced broken lines in FIGS. 1-9 represent stitching and form part of the claimed design.

1 Claim, 3 Drawing Sheets

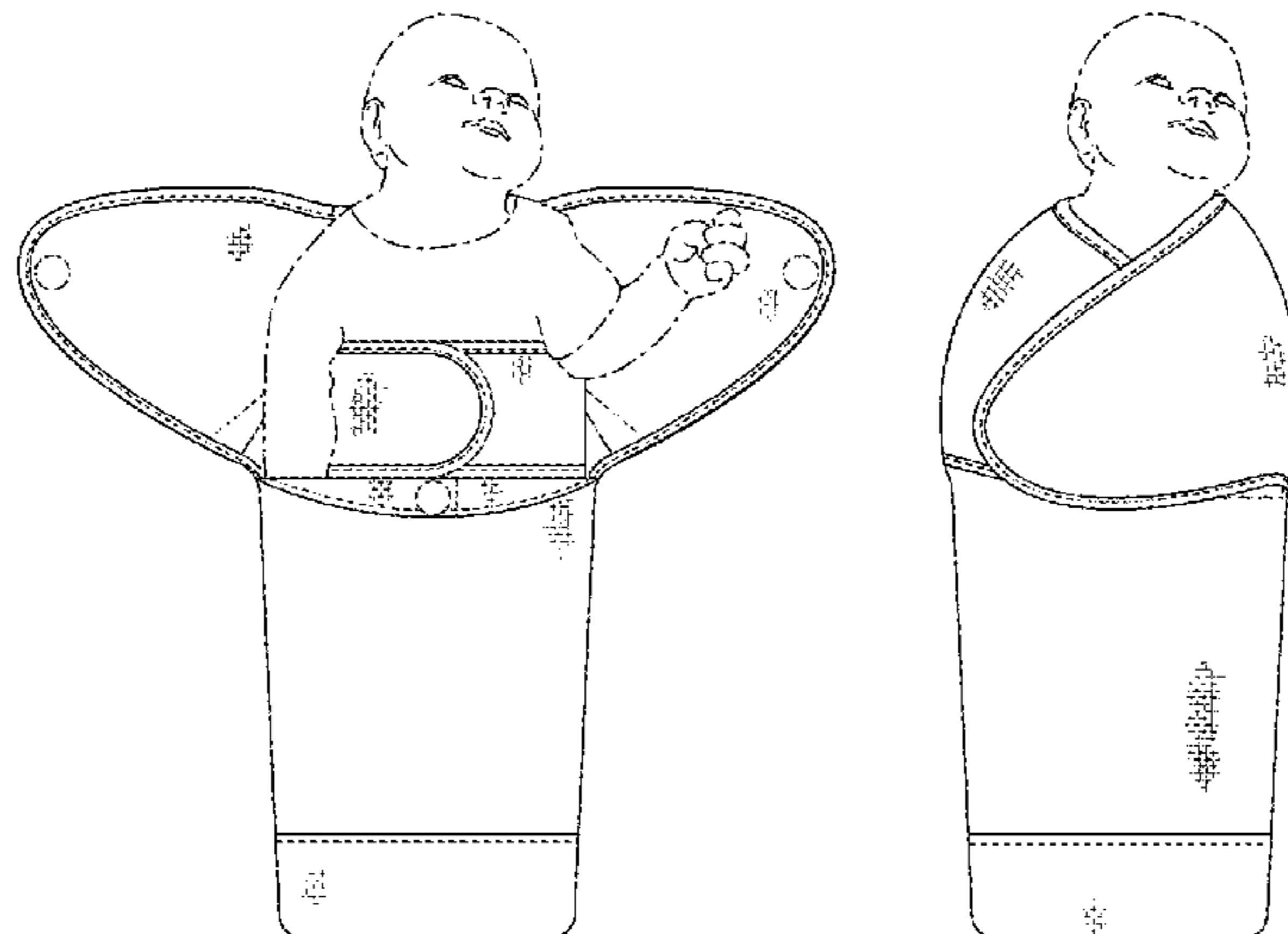

(56)

References Cited

U.S. PATENT DOCUMENTS

857,507 A 6/1907 Wilson
 1,370,009 A * 3/1921 Ehrenberg 128/873
 1,474,738 A 11/1923 Thierjung
 1,584,853 A 5/1926 Dern
 1,897,521 A 2/1933 LaGarde
 1,964,271 A 6/1934 O'Dwyer
 2,227,751 A 1/1941 Idelman
 2,342,069 A 2/1944 Wilkinson
 2,423,392 A 7/1947 Krogh
 2,440,891 A 5/1948 Bockhold
 2,450,923 A 10/1948 Spiro, Jr.
 2,481,741 A 9/1949 Graves
 2,503,427 A 4/1950 Waterworth
 2,563,501 A 8/1951 Sperling
 2,596,547 A 5/1952 Guest
 2,677,834 A 5/1954 Moynihan
 2,693,177 A 11/1954 Barstow
 2,702,385 A 2/1955 Goldberg
 2,803,824 A * 8/1957 Parish 2/69.5
 2,940,443 A 6/1960 Baker
 2,989,753 A 6/1961 Burner
 3,034,132 A 5/1962 Lansdberger et al.
 3,412,407 A 11/1968 Key
 3,477,065 A 11/1969 Hoover
 3,521,309 A 7/1970 Evans
 3,739,399 A 6/1973 Sheahon
 3,845,513 A 11/1974 Hubner et al.
 3,848,281 A 11/1974 Mathews
 3,854,156 A 12/1974 Williams
 3,987,505 A 10/1976 Hickey
 4,172,300 A 10/1979 Miller
 4,199,830 A 4/1980 Ogata et al.
 4,202,052 A 5/1980 Bilanzich
 4,445,242 A 5/1984 Bowen
 4,597,121 A 7/1986 Bouma
 4,611,353 A * 9/1986 Als et al. 2/69
 4,627,363 A 12/1986 Jones
 4,653,131 A 3/1987 Diehl
 4,688,282 A 8/1987 Jeffries
 4,783,866 A 11/1988 Simmons et al.
 4,839,934 A 6/1989 Rojas
 4,858,259 A 8/1989 Simmons et al.
 4,858,625 A 8/1989 Cramer
 4,878,258 A 11/1989 Casey
 4,887,326 A 12/1989 O'Brien et al.
 4,897,885 A 2/1990 Lunt
 4,937,904 A 7/1990 Ross
 5,046,204 A 9/1991 Mohler
 5,084,929 A 2/1992 Staudinger
 5,131,096 A 7/1992 Olson
 5,148,560 A 9/1992 Torres
 5,168,590 A 12/1992 O'Sullivan
 5,243,724 A 9/1993 Barnes
 5,297,304 A 3/1994 O'Sullivan
 5,367,731 A 11/1994 O'Sullivan
 D355,068 S 2/1995 Prendergast
 5,400,803 A 3/1995 Vines
 5,416,938 A 5/1995 Li
 5,439,008 A 8/1995 Bowman
 5,488,746 A 2/1996 Hudson
 5,557,817 A 9/1996 Haddock
 5,572,757 A 11/1996 O'Sullivan
 5,722,094 A 3/1998 Ruefer
 5,746,219 A 5/1998 McConnell
 5,852,827 A 12/1998 Lear
 5,950,261 A 9/1999 Hay et al.
 5,996,147 A 12/1999 Trimble
 6,009,576 A 1/2000 Gramme et al.
 6,052,850 A 4/2000 Sali do et al.
 6,105,168 A 8/2000 Hazen
 6,243,896 B1 6/2001 Osuna et al.
 6,266,832 B1 7/2001 Ezell
 6,286,163 B1 9/2001 Trimble
 6,301,729 B1 10/2001 Hall et al.

6,341,397 B1 1/2002 Kliegl et al.
 6,415,442 B1 7/2002 Smith
 6,499,165 B1 12/2002 Morgillo et al.
 D468,951 S 1/2003 Harris
 6,631,528 B2 10/2003 Landry
 6,640,340 B2 11/2003 Gibson
 6,662,390 B1 12/2003 Berger
 6,681,422 B2 1/2004 Landry
 6,817,048 B1 11/2004 LaRosa
 6,848,131 B1 2/2005 Landry
 6,857,146 B2 2/2005 Landry
 6,868,566 B2 3/2005 Gatten
 D504,753 S 5/2005 Gold et al.
 6,928,674 B2 8/2005 Blackburn
 D513,357 S 1/2006 Allard
 7,043,783 B2 5/2006 Gatten
 7,111,344 B2 9/2006 French et al.
 7,150,054 B1 12/2006 Byrne et al.
 7,181,789 B2 2/2007 Gatten
 7,254,849 B1 8/2007 Fiebrich et al.
 7,337,482 B2 3/2008 Byrne et al.
 7,370,377 B2 5/2008 Landry
 7,681,261 B1 3/2010 O'Neill
 7,774,875 B1 8/2010 Zeidman
 7,954,187 B1 * 6/2011 Earnest 5/494
 D644,413 S * 9/2011 Keall et al. D2/719
 8,117,698 B1 2/2012 Khaze Harry
 8,191,188 B2 6/2012 Kaplan et al.
 D675,808 S 2/2013 Sutton
 8,667,631 B2 * 3/2014 Coates 5/655
 8,745,794 B1 * 6/2014 McDermott 5/655
 D715,027 S * 10/2014 Daugherty et al. D2/719
 8,910,332 B2 * 12/2014 Buckson 5/655
 8,943,625 B2 * 2/2015 Gotel et al. 2/69.5
 2003/0131411 A1 7/2003 Gibson
 2003/0154548 A1 8/2003 Landry
 2003/0154549 A1 8/2003 Landry
 2004/0019969 A1 2/2004 Gatten
 2004/0019970 A1 2/2004 Landry
 2004/0139527 A1 7/2004 Damir et al.
 2004/0199999 A1 10/2004 Landry
 2004/0216230 A1 11/2004 Blackburn
 2005/0028278 A1 2/2005 Landry
 2005/0125895 A1 6/2005 Gatten
 2006/0010600 A1 1/2006 Kendy
 2006/0150330 A1 7/2006 Gatten
 2007/0061968 A1 3/2007 Fader
 2007/0094795 A1 5/2007 Byrne et al.
 2007/0220675 A1 9/2007 Haskins et al.
 2009/0064390 A1 3/2009 Beiring et al.
 2010/0275373 A1 11/2010 Kaplan et al.
 2011/0179546 A1 7/2011 Millette et al.
 2011/0231993 A1 9/2011 Schmid et al.
 2012/0110716 A1 5/2012 Christensen et al.
 2012/0216349 A1 8/2012 Kaplan et al.
 2012/0284922 A1 11/2012 Gangan et al.
 2013/0283527 A1 * 10/2013 Houston et al. 5/494
 2014/0020177 A1 * 1/2014 Coates 5/494
 2014/0033430 A1 * 2/2014 Daugherty et al. 5/494

FOREIGN PATENT DOCUMENTS

DE 202013006879 U1 * 10/2013 A47G 9/068
 FR 2730617 8/1996
 FR EP 2543269 A1 * 1/2013 A41B 13/06
 GB 927094 5/1963
 GB 2281510 3/1995
 JP 60-164980 11/1985
 JP 2-46846 2/1990
 JP 5-72265 10/1993
 JP 6-33577 5/1994
 JP 3057370 5/1999
 JP 2008-255533 10/2008
 NL EP 1190631 A2 * 3/2002 A41B 13/06
 WO WO-9317606 9/1993

* cited by examiner

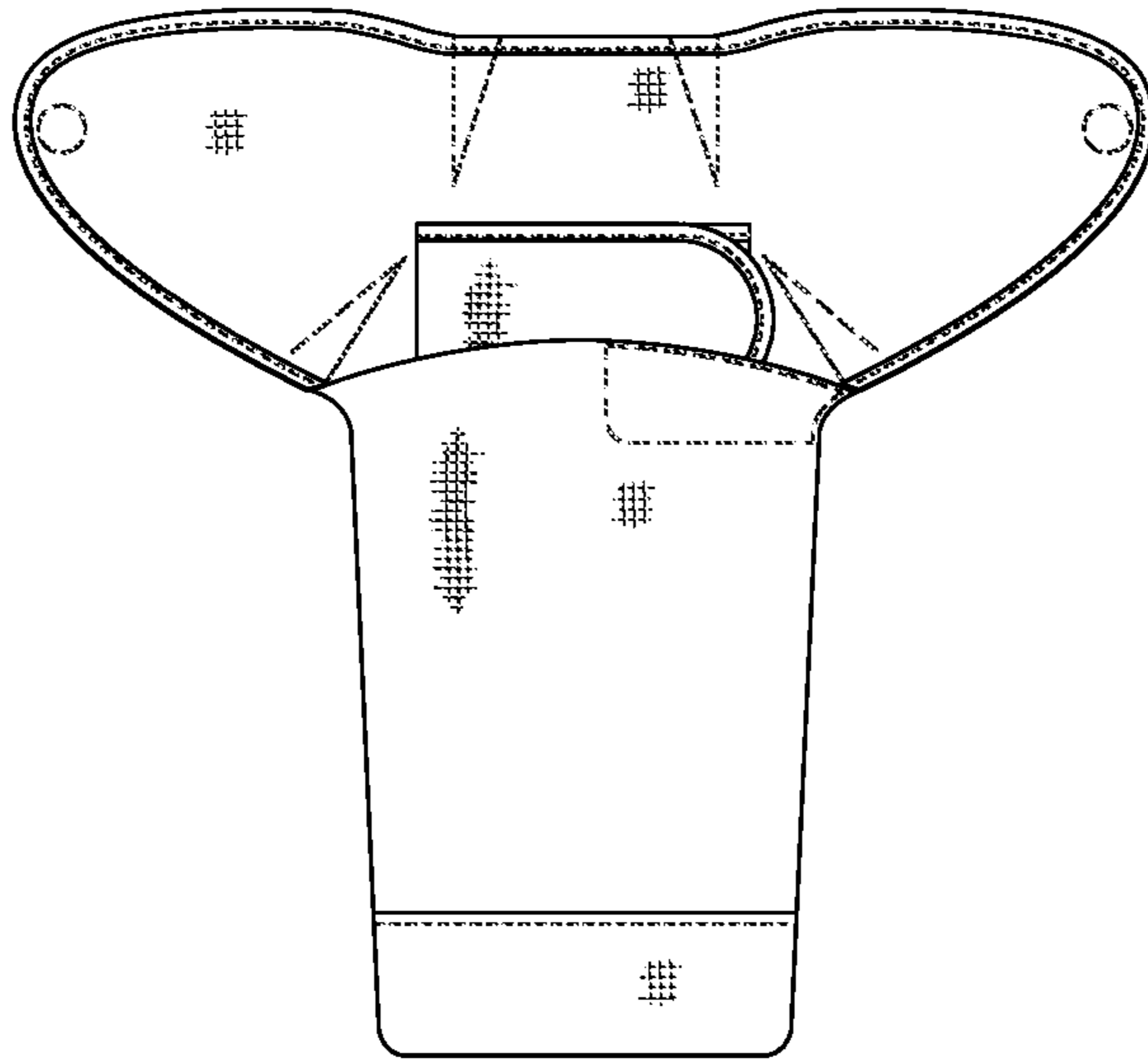

Fig. 1

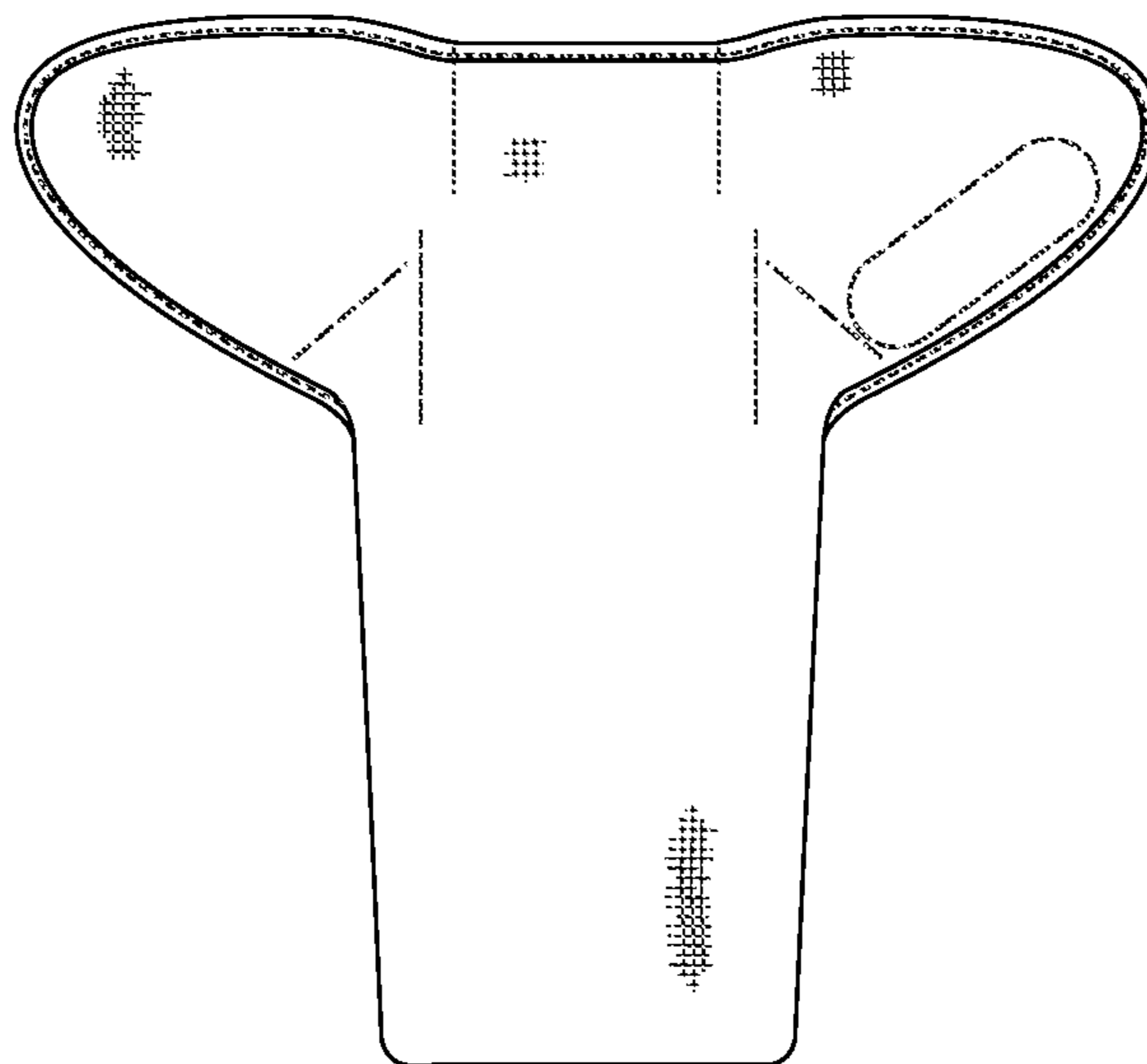

Fig. 2

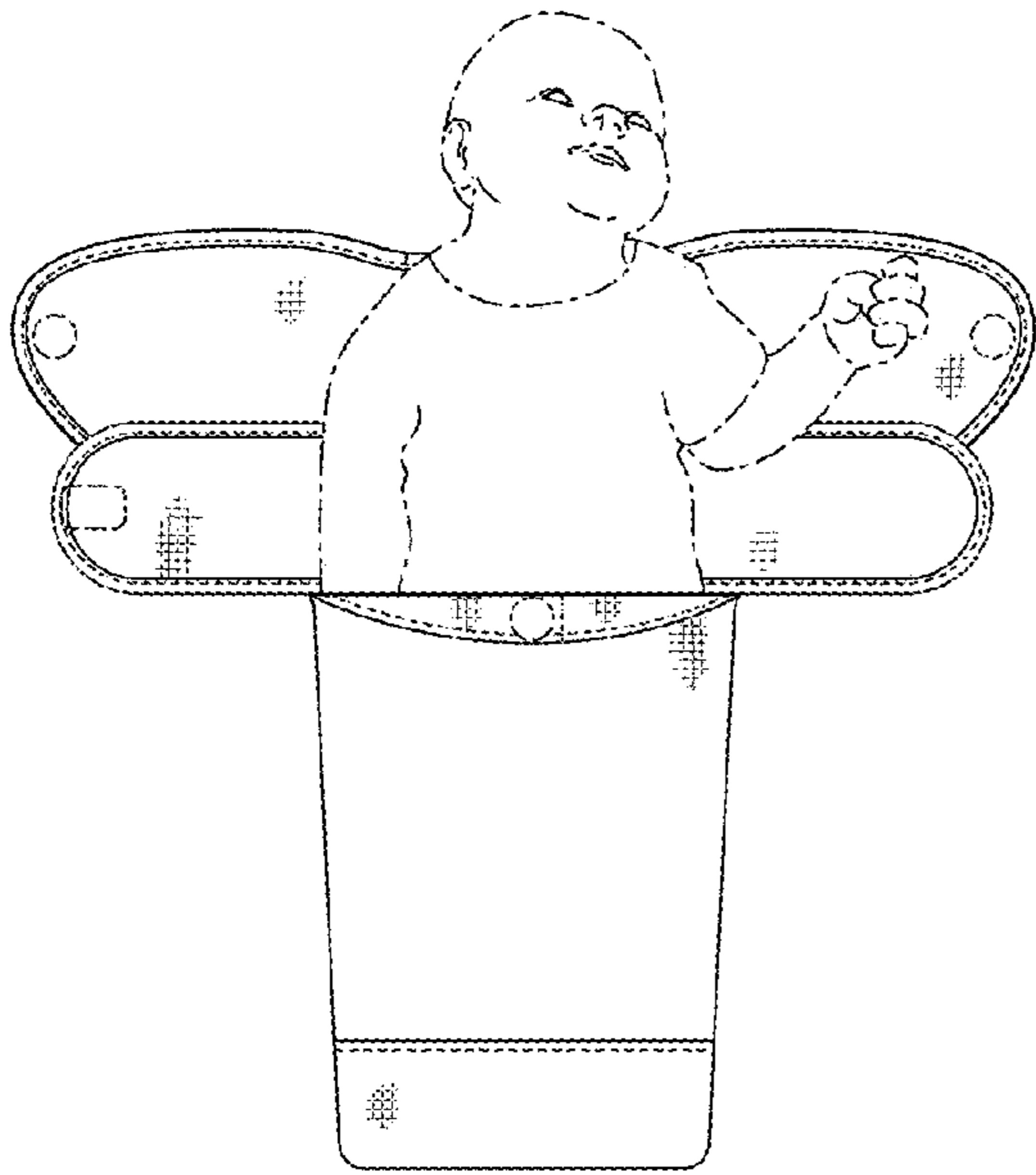

Fig. 3

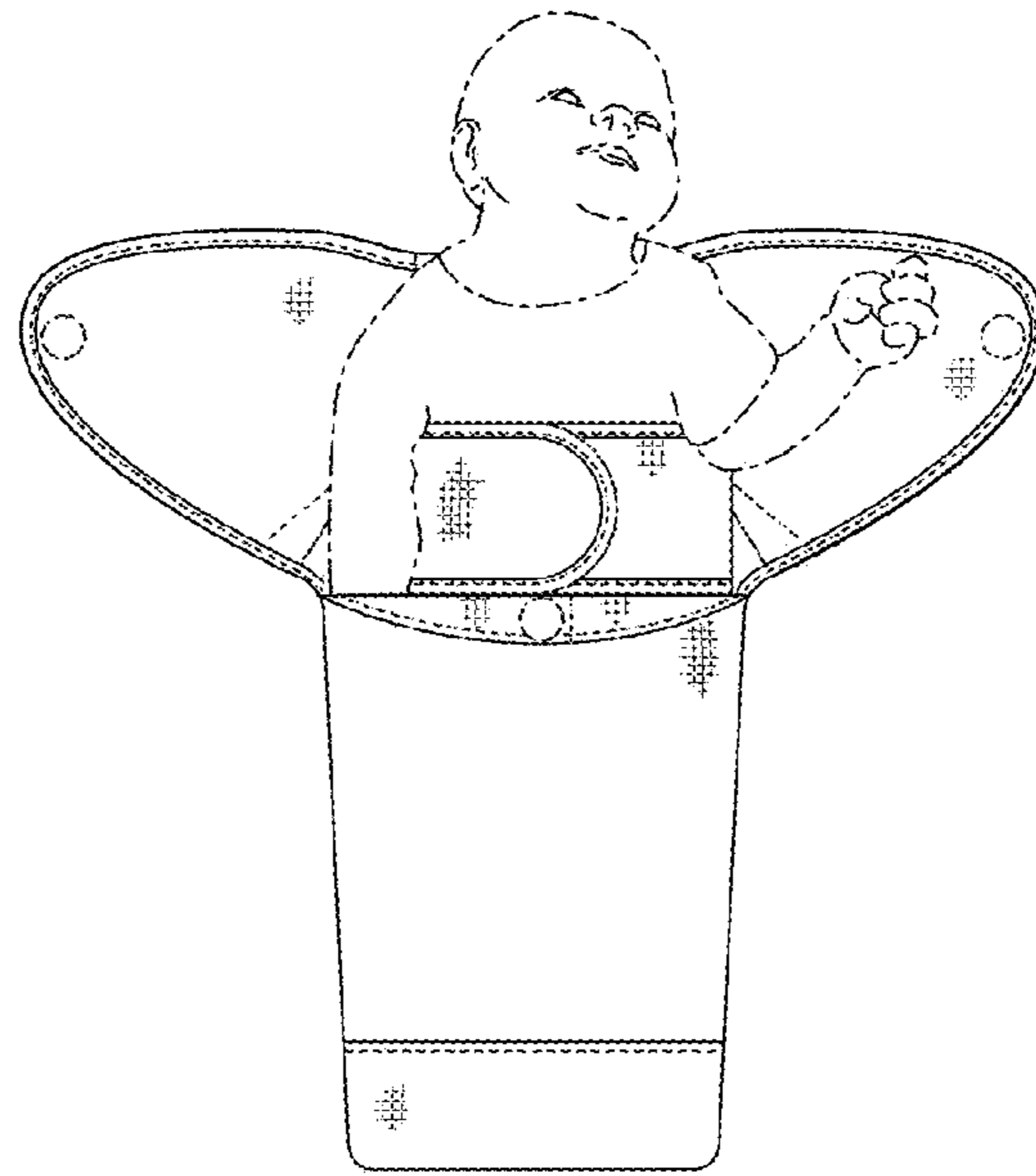

Fig. 4

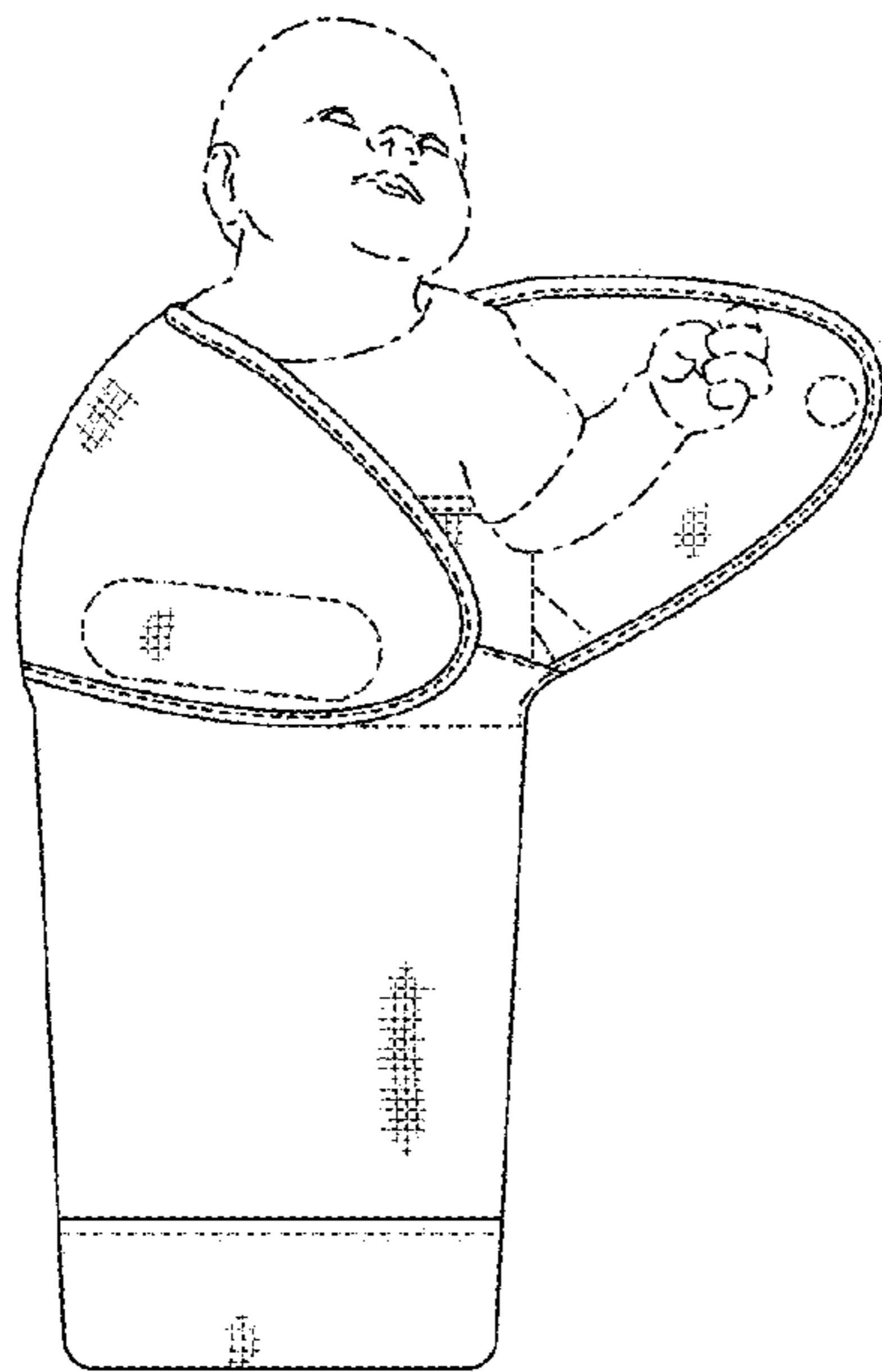

Fig. 5

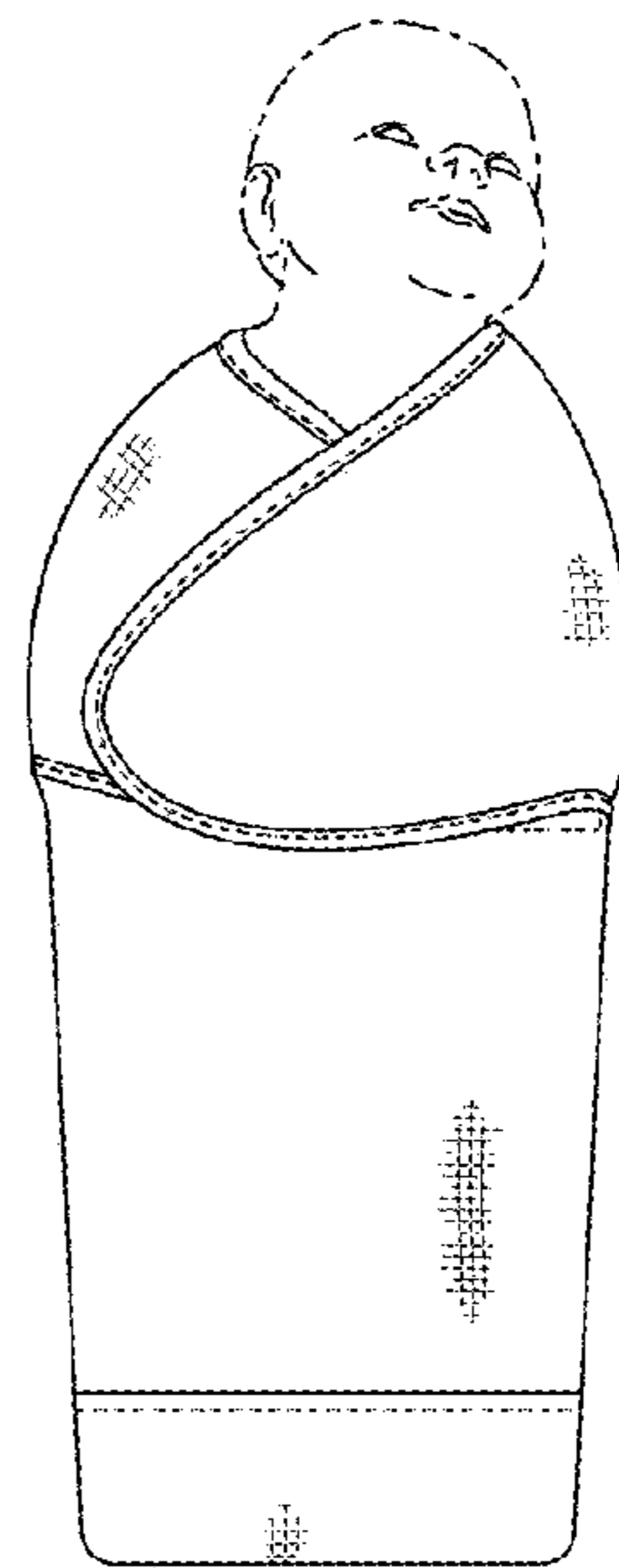

Fig. 6

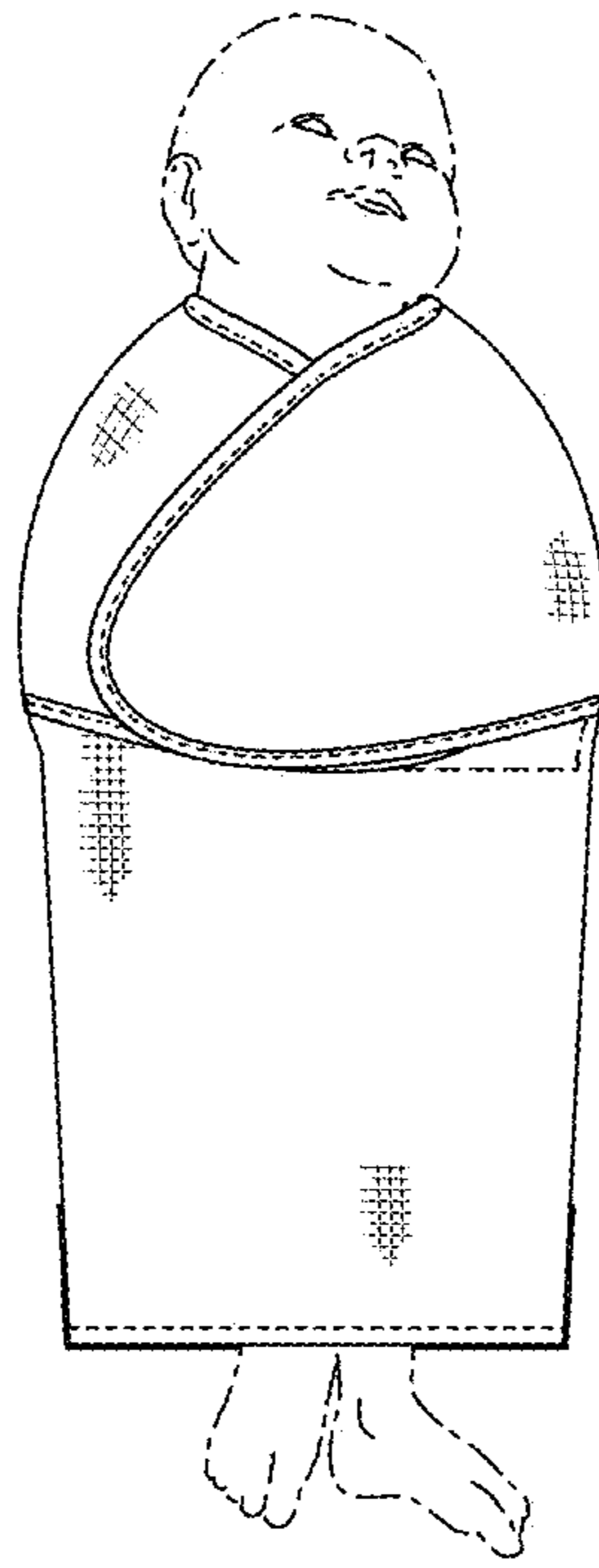

Fig. 7

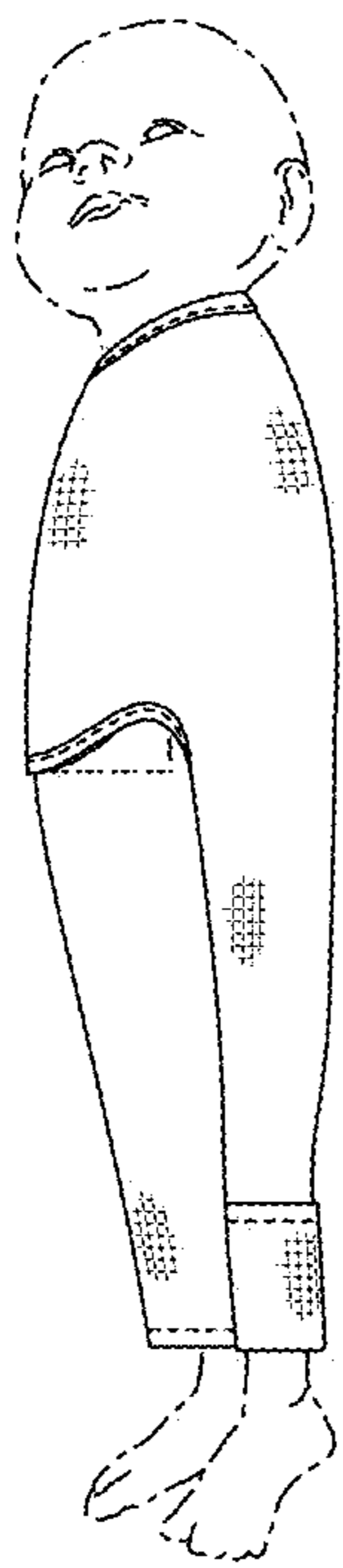

Fig. 8

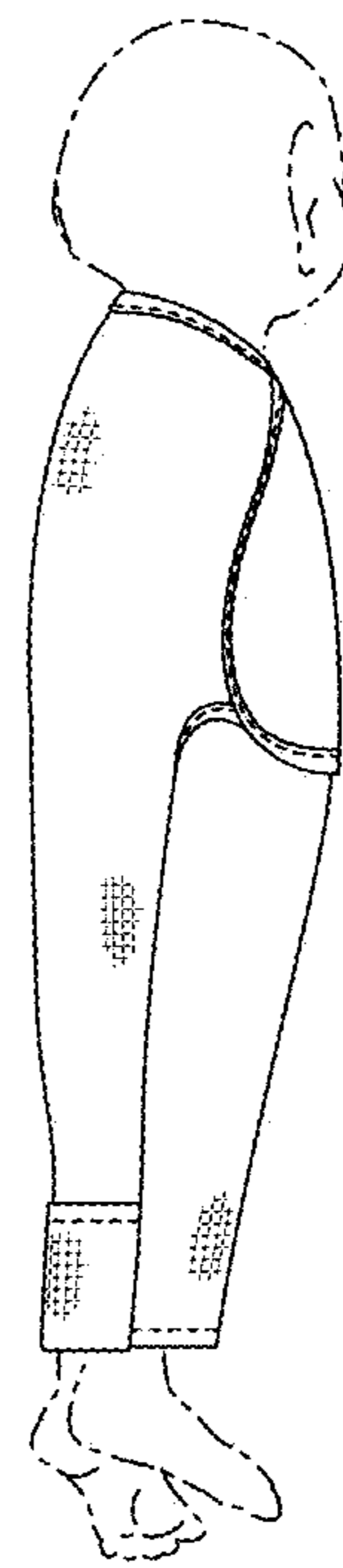

Fig. 9