



US00D741548S

(12) **United States Design Patent**  
**Ladewig**

(10) **Patent No.:** **US D741,548 S**  
(45) **Date of Patent:** **\*\* Oct. 20, 2015**

(54) **LUMINAIRE**

(71) Applicant: **Christopher Ladewig**, Fayetteville, GA (US)

(72) Inventor: **Christopher Ladewig**, Fayetteville, GA (US)

(73) Assignee: **Cooper Technologies Company**, Houston, TX (US)

(\*\*) Term: **14 Years**

(21) Appl. No.: **29/464,520**

(22) Filed: **Aug. 16, 2013**

(51) **LOC (10) Cl.** ..... **26-03**

(52) **U.S. Cl.**  
USPC ..... **D28/67**

(58) **Field of Classification Search**  
USPC ..... D26/24, 93, 103-107, 110-112, 67, 68  
CPC ..... F21S 6/00; F21S 6/002; F21V 1/00;  
F21V 1/02; F21V 21/02; F21V 1/12; F21V 1/22; F21V 1/18; F21W 2131/30  
See application file for complete search history.

(56) **References Cited**

**U.S. PATENT DOCUMENTS**

D468,478 S *	1/2003	Landefeld et al. ....	D26/106
D499,503 S *	12/2004	Hon et al. ....	D26/67
D592,343 S *	5/2009	Wilcox et al. ....	D26/67
D670,018 S *	10/2012	Sauvage ....	D26/68
D678,576 S *	3/2013	Chen ....	D26/67
D713,082 S *	9/2014	Hermansen et al. ....	D26/67
D716,989 S *	11/2014	Sooferian ....	D26/68

**OTHER PUBLICATIONS**

Cooper Lighting; Invue; MSA Mesa LED, Product specification; Feb. 26, 2013.

\* cited by examiner

*Primary Examiner* — Brian N Vinson

(74) *Attorney, Agent, or Firm* — King & Spalding LLP

(57) **CLAIM**

The ornamental design for a luminaire, as shown and described.

**DESCRIPTION**

FIG. 1 is a perspective view of an embodiment of a luminaire, showing my new design;

FIG. 2 is a front side elevation view thereof;

FIG. 3 is a right side elevation view thereof;

FIG. 4 is a back side elevation view thereof;

FIG. 5 is a left side elevation view thereof;

FIG. 6 is a top plan view thereof; and

FIG. 7 is a bottom plan view thereof;

FIG. 8 is a perspective view of another embodiment of a luminaire, showing my new design;

FIG. 9 is a front side elevation view thereof;

FIG. 10 is a right side elevation view thereof;

FIG. 11 is a back side elevation view thereof;

FIG. 12 is a left side elevation view thereof;

FIG. 13 is a top plan view thereof; and,

FIG. 14 is a bottom plan view thereof.

The broken line disclosure represents portions of the luminaire which form no part of the claimed design, and no claim is made to the area between the dash-dot-dot-dash broken away lines.

**1 Claim, 12 Drawing Sheets**

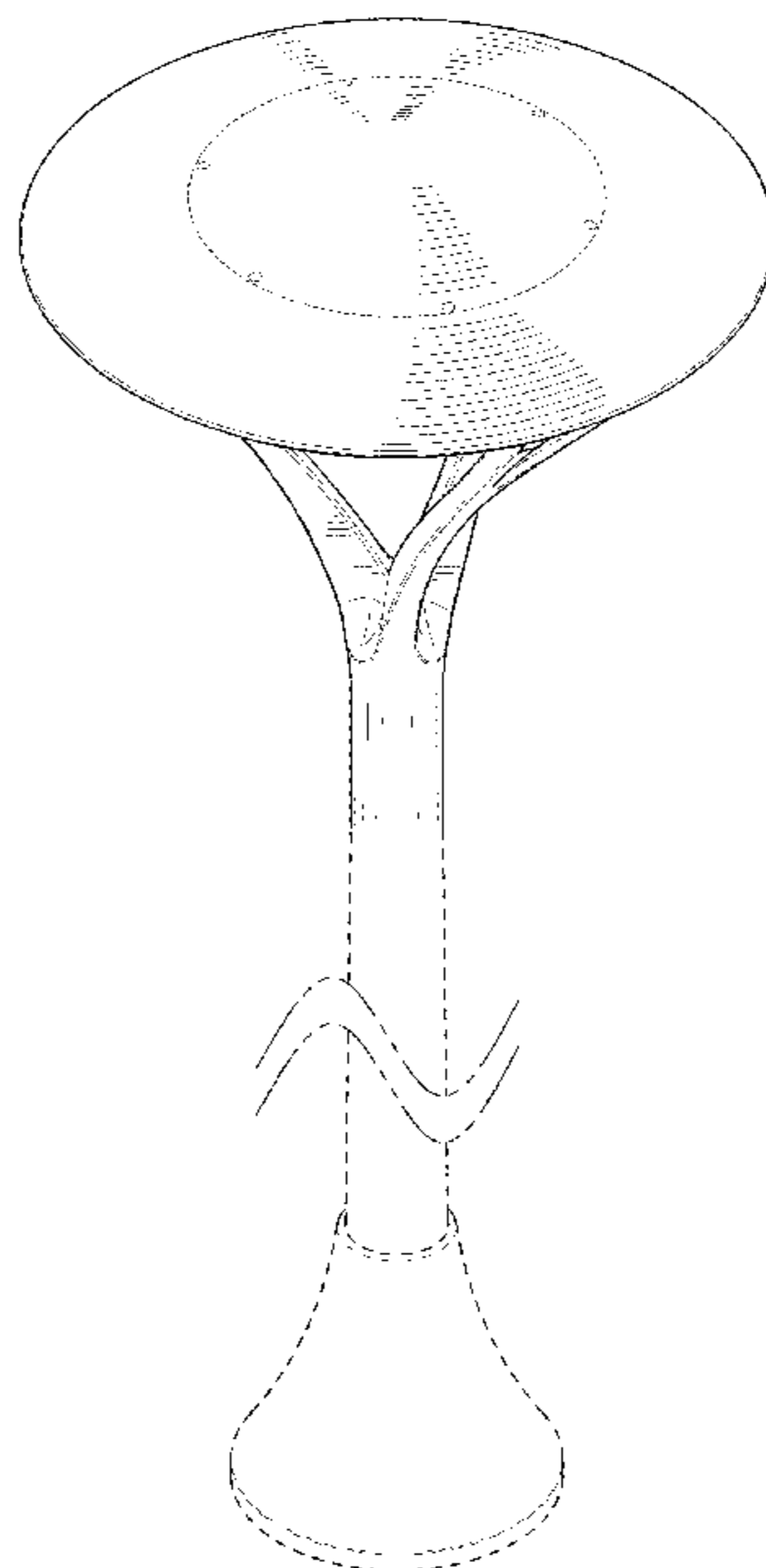

FIG. 1

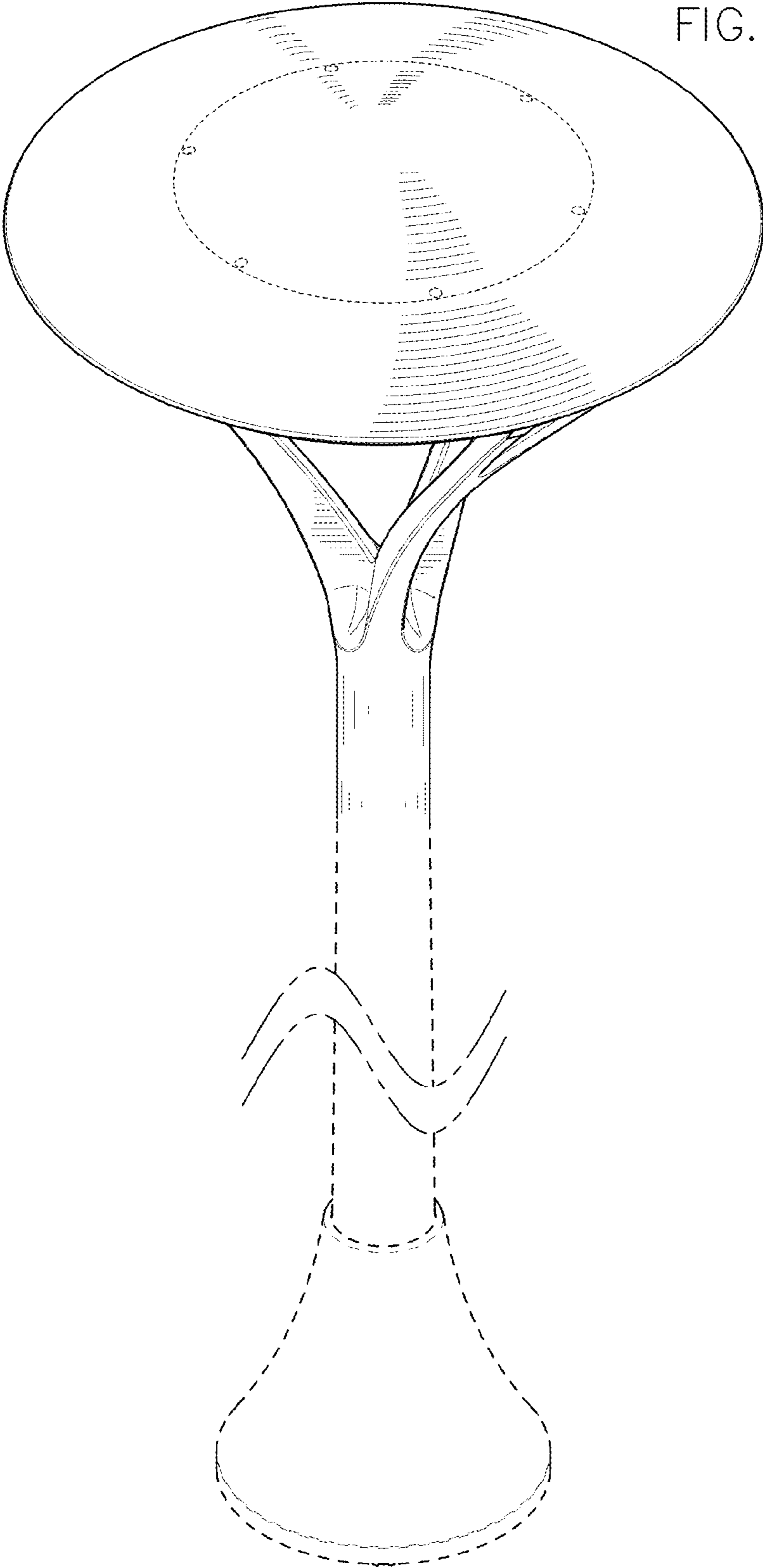

FIG. 2

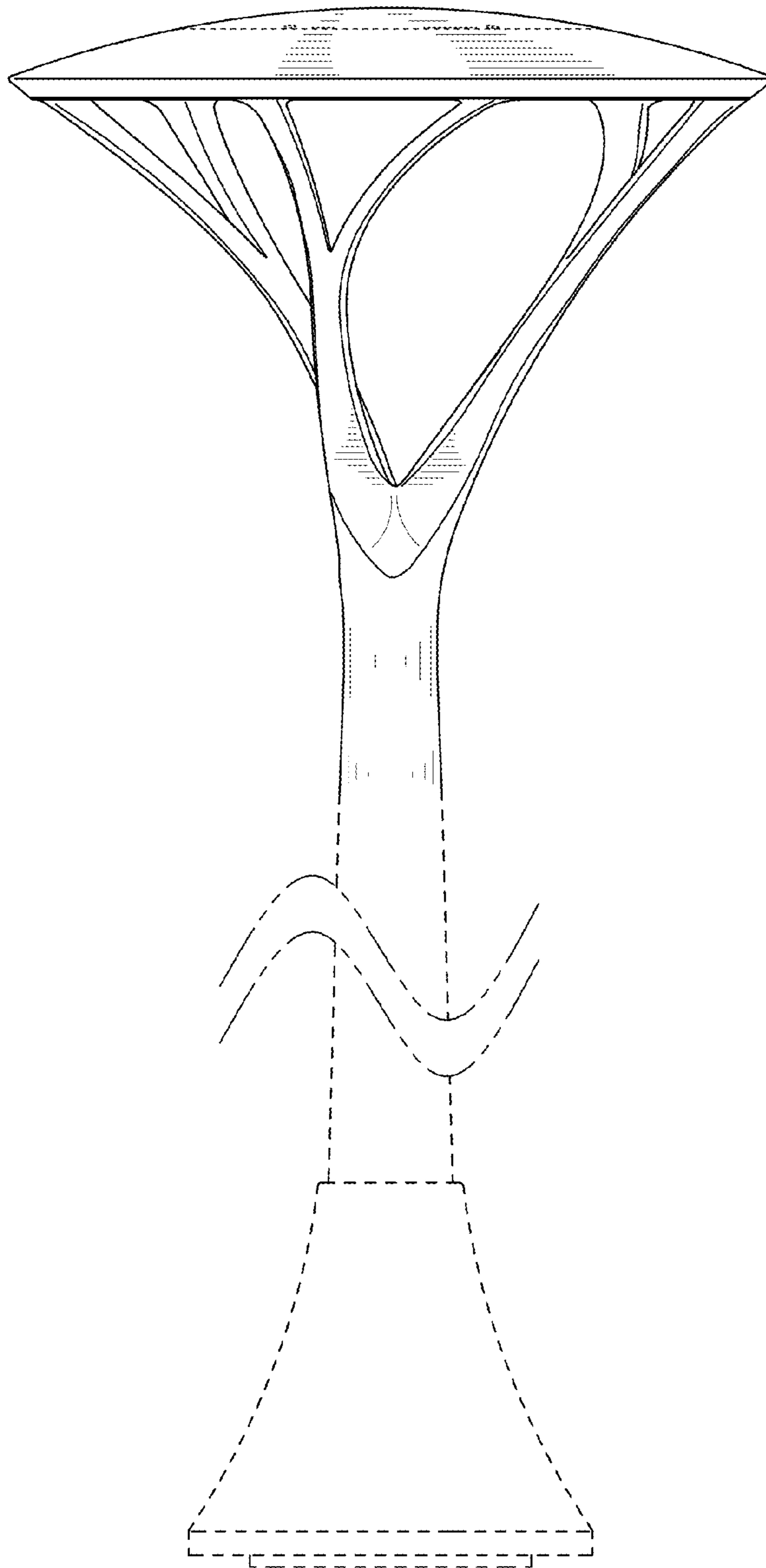

FIG. 3

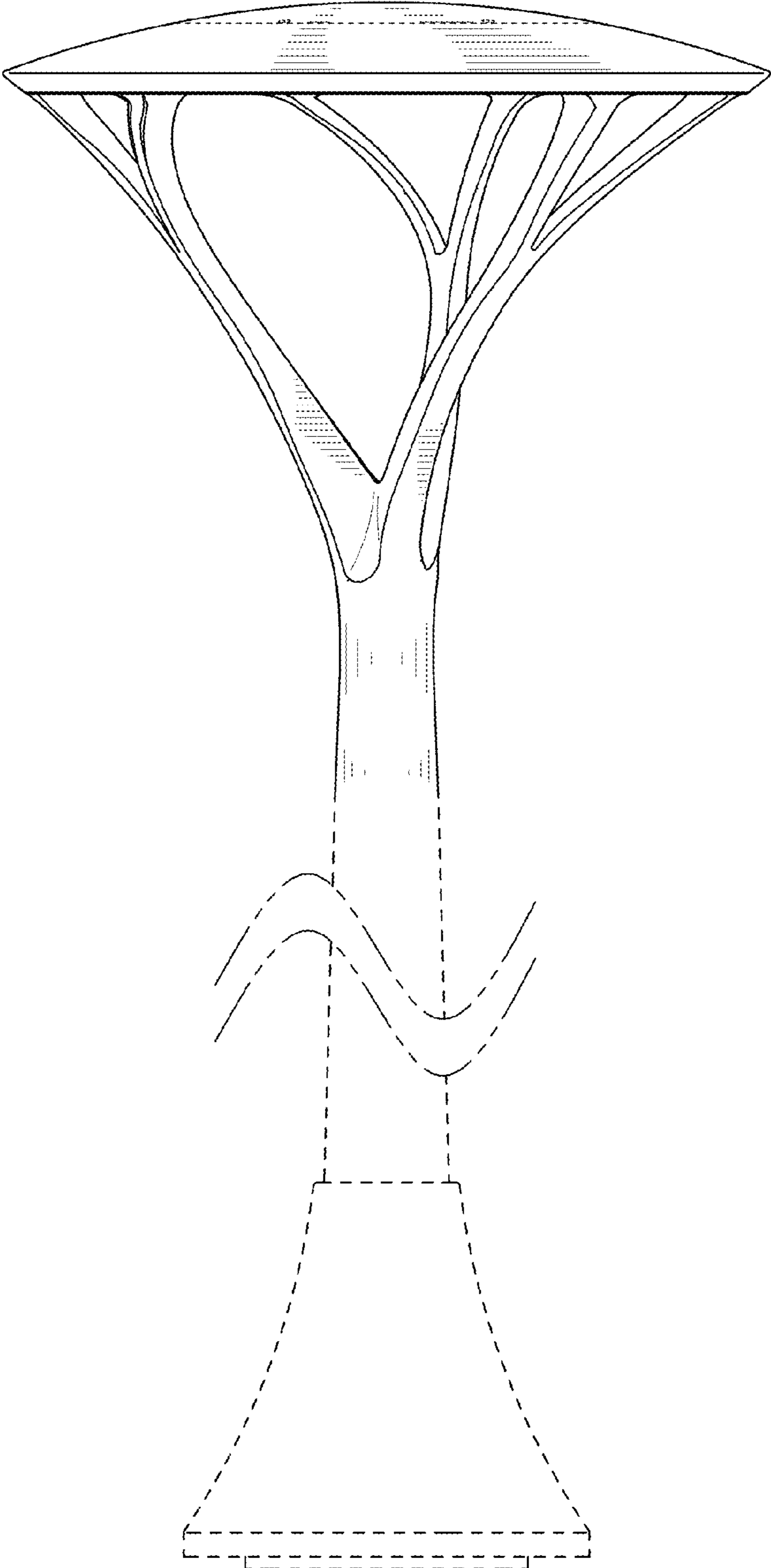

FIG. 4

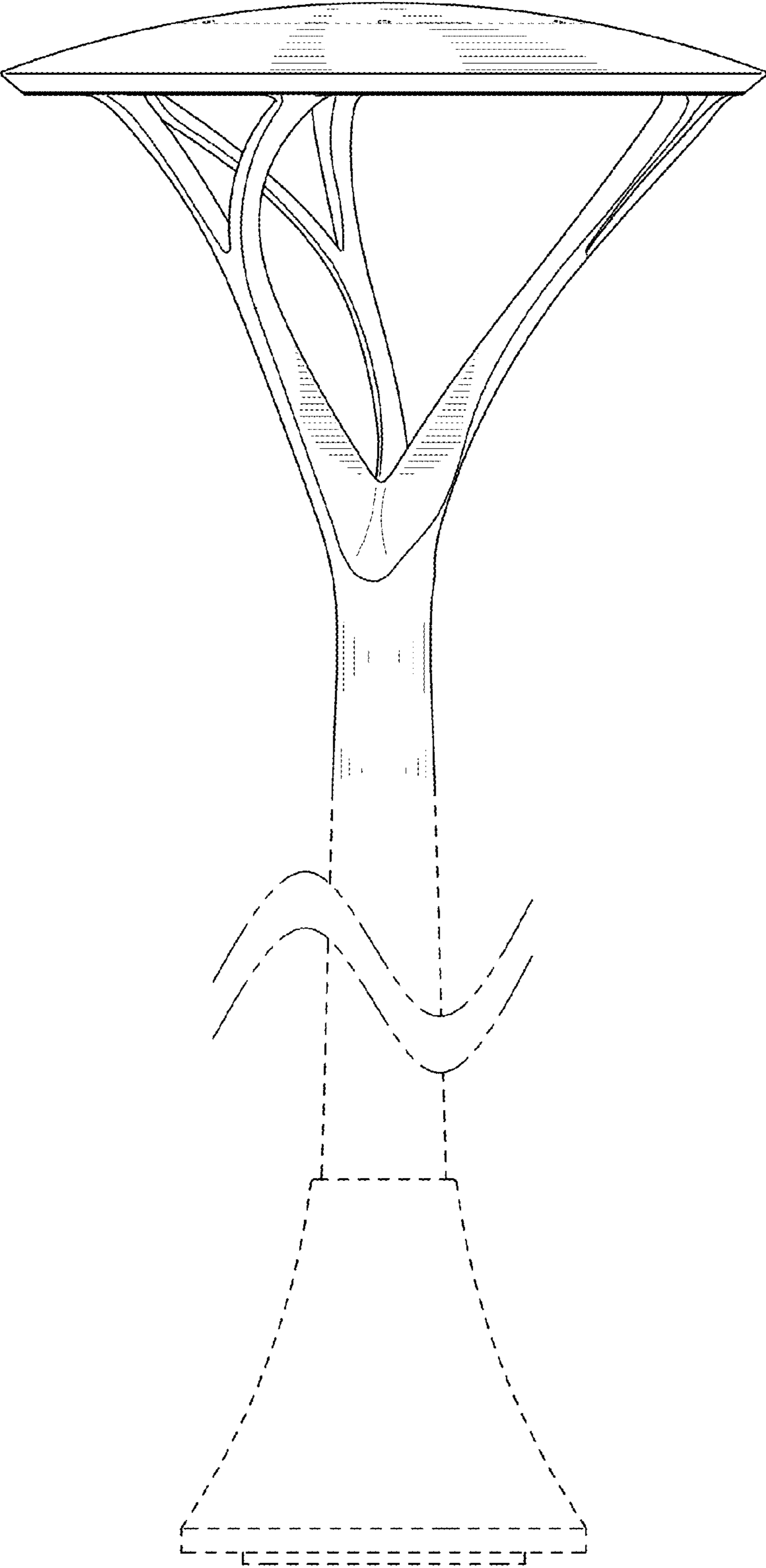

FIG. 5

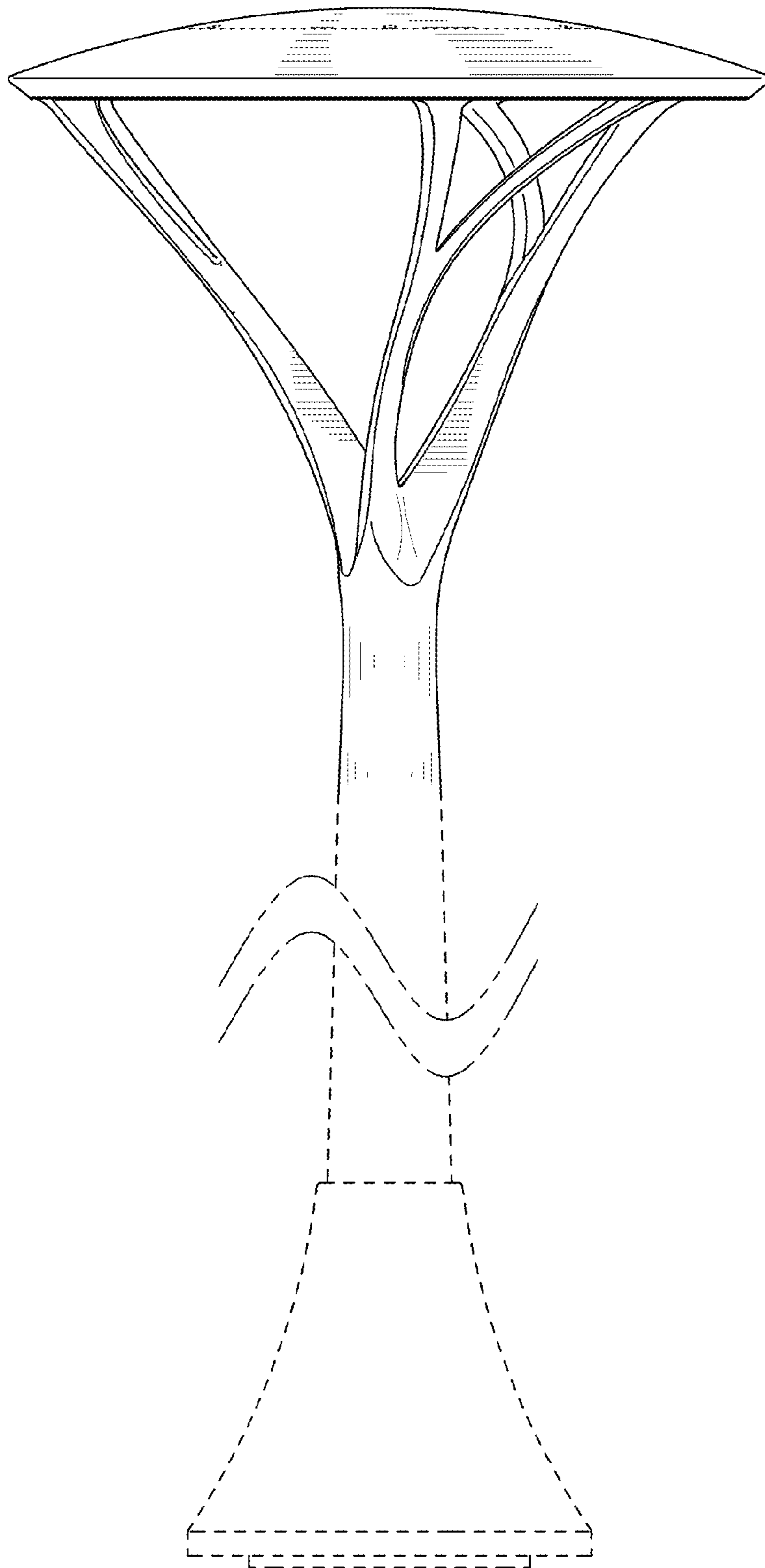

FIG. 6

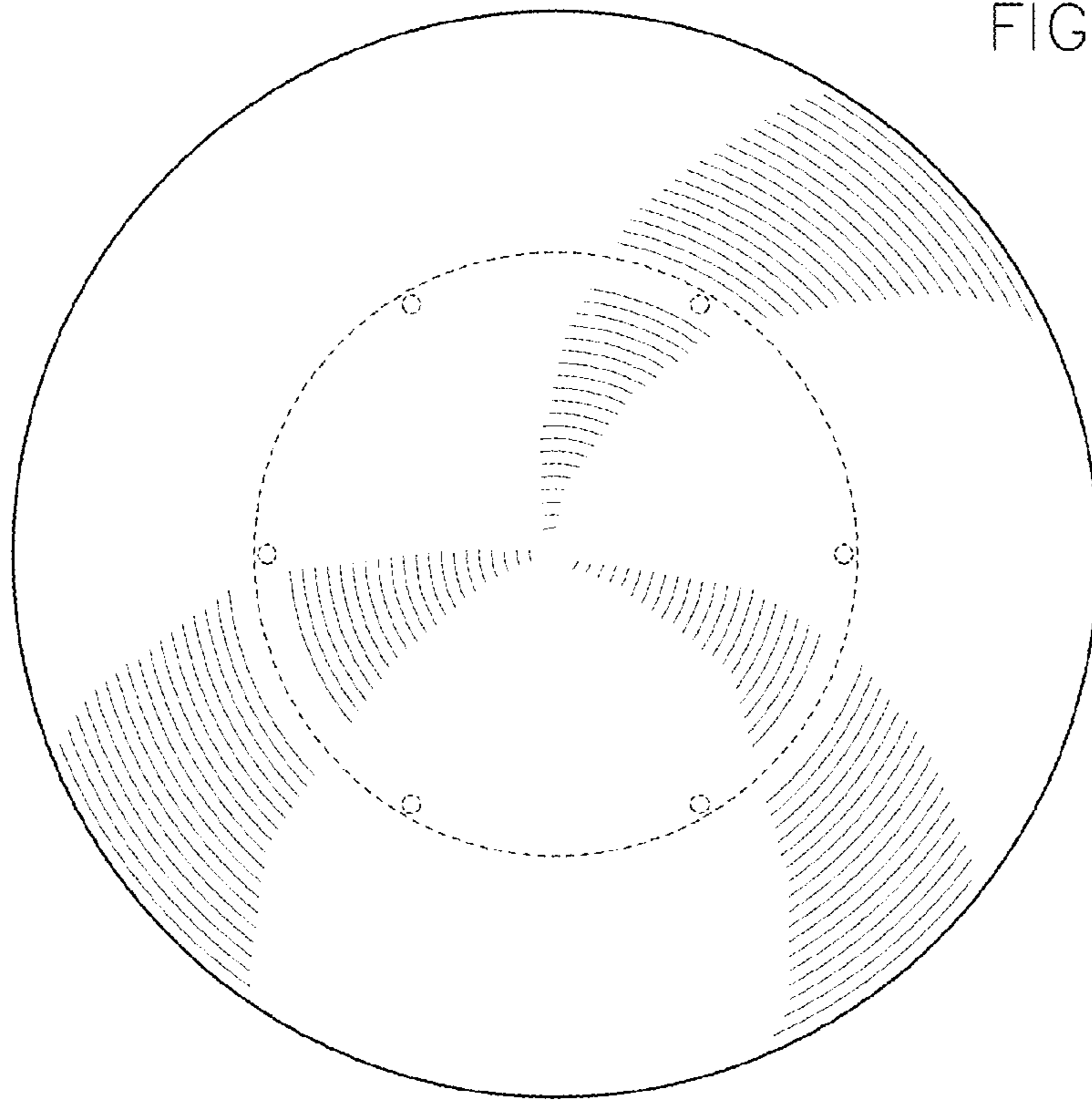

FIG. 7

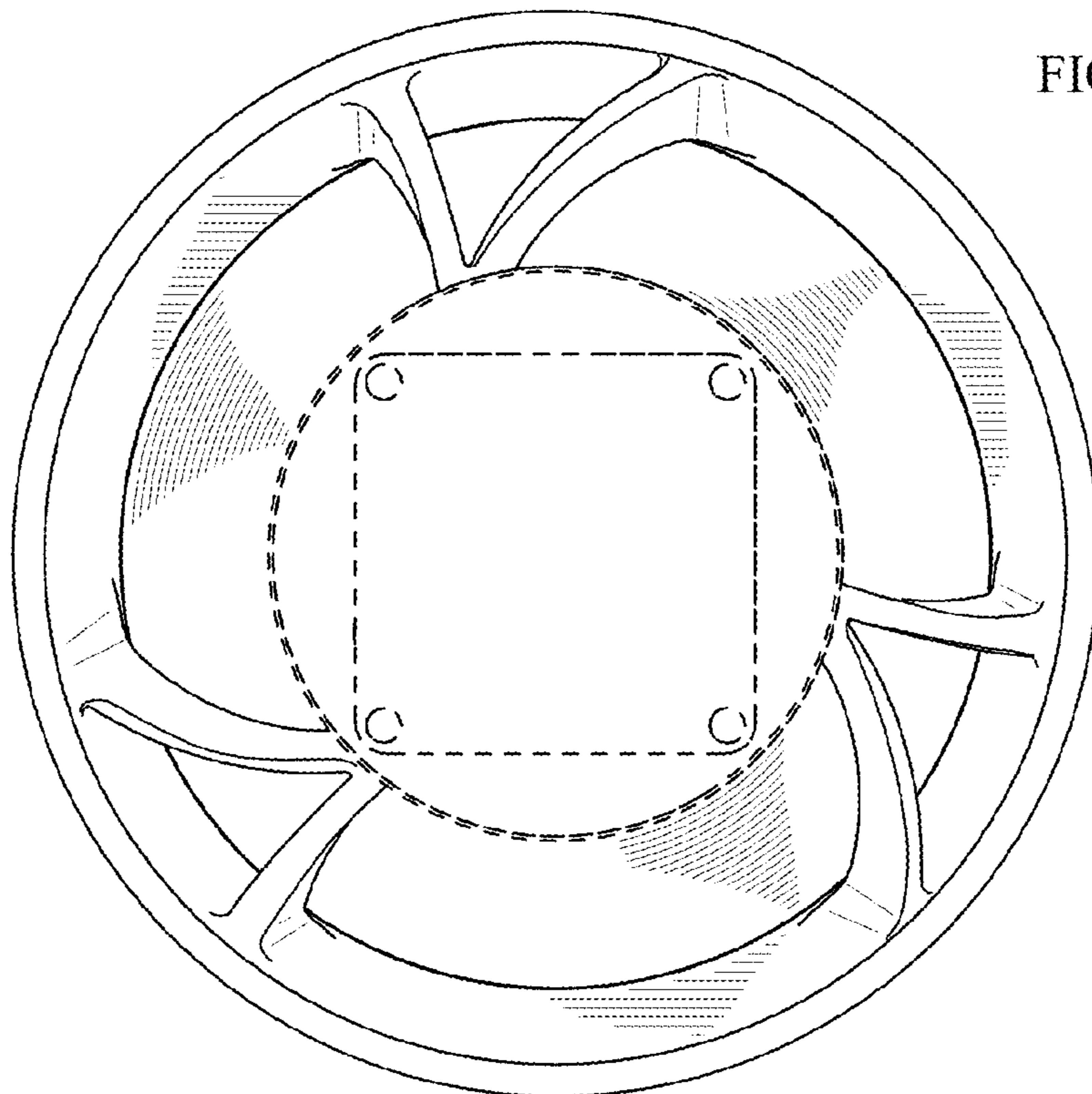

FIG. 8

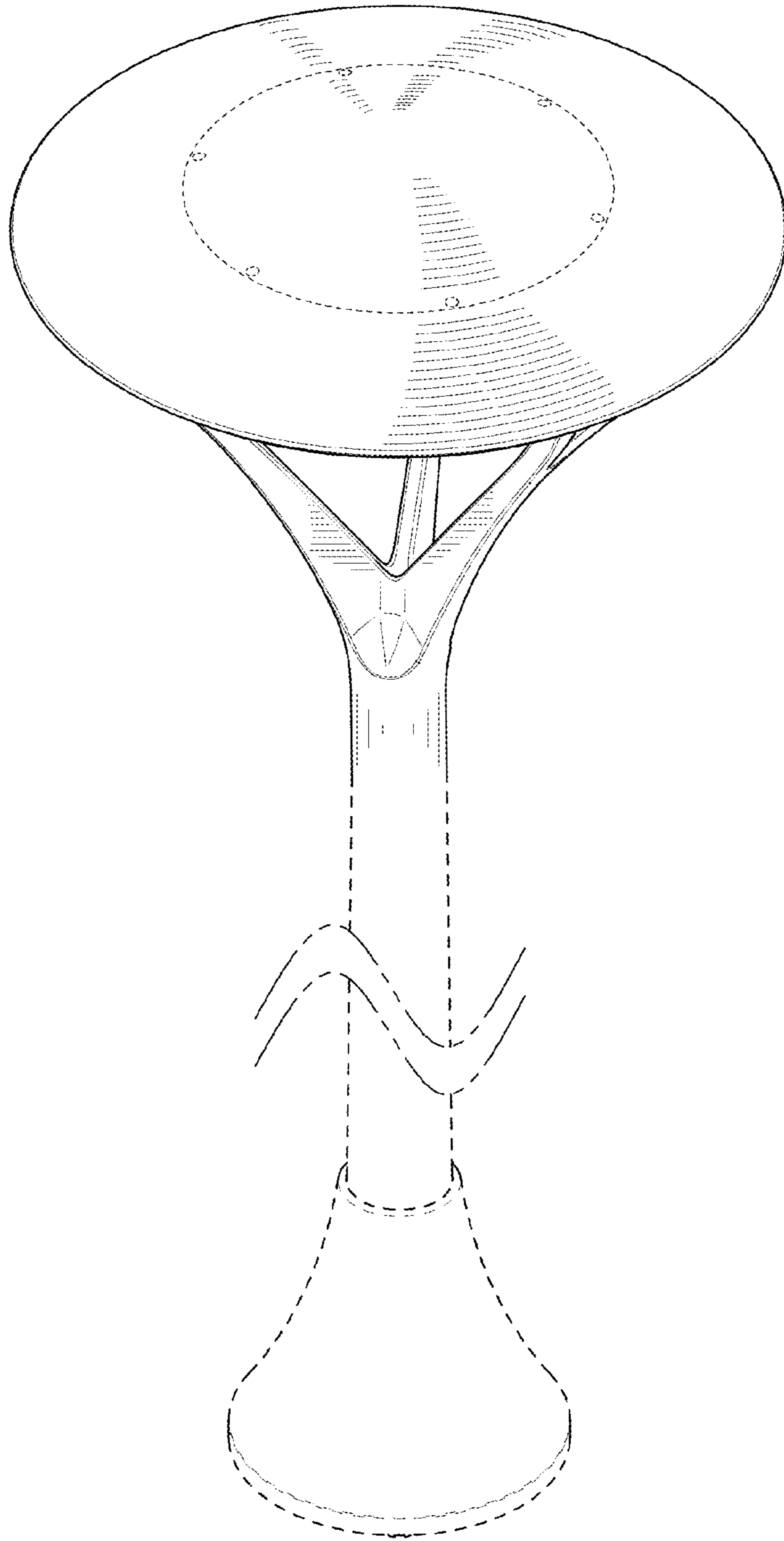



FIG. 9

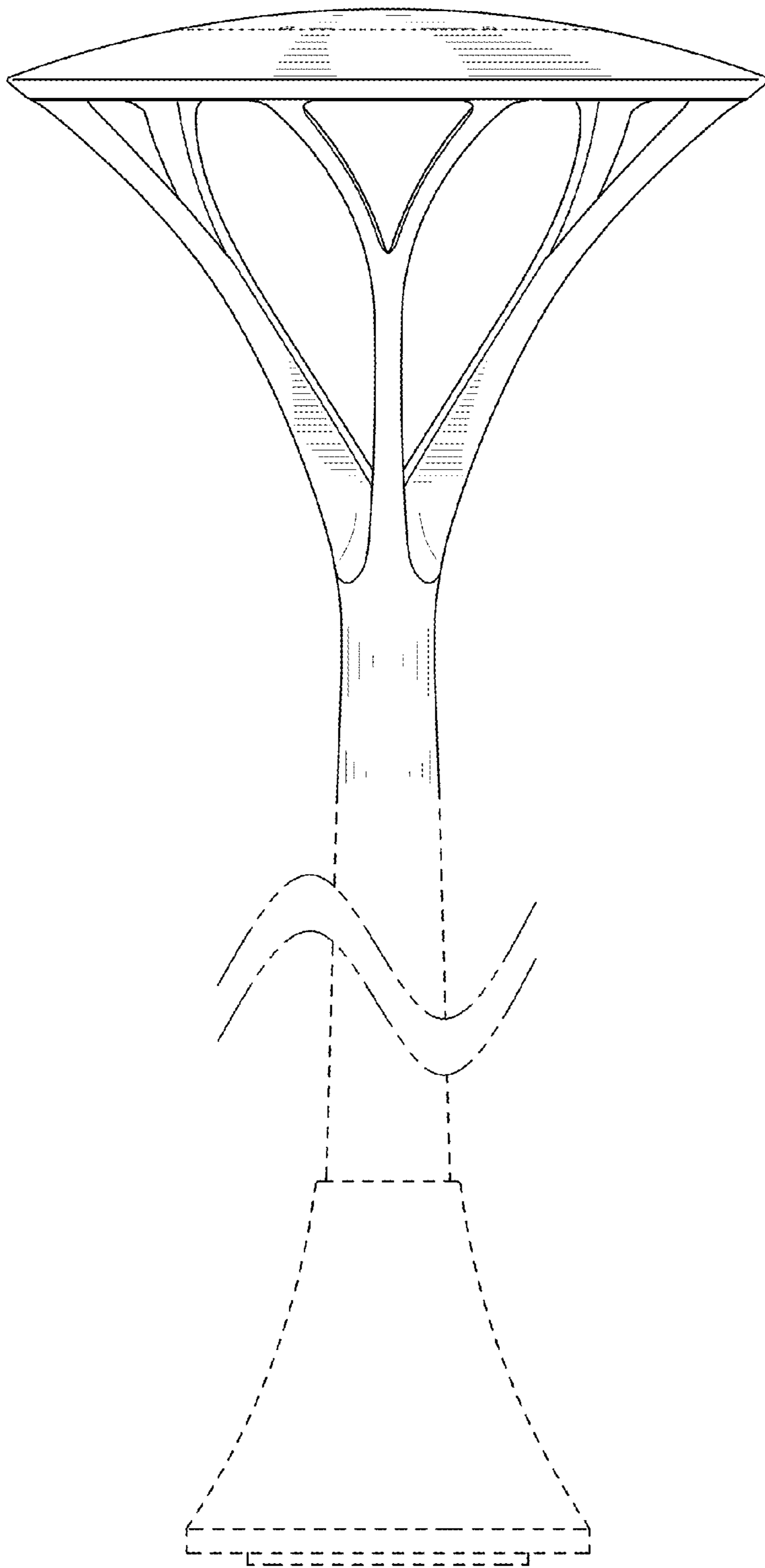

FIG. 10

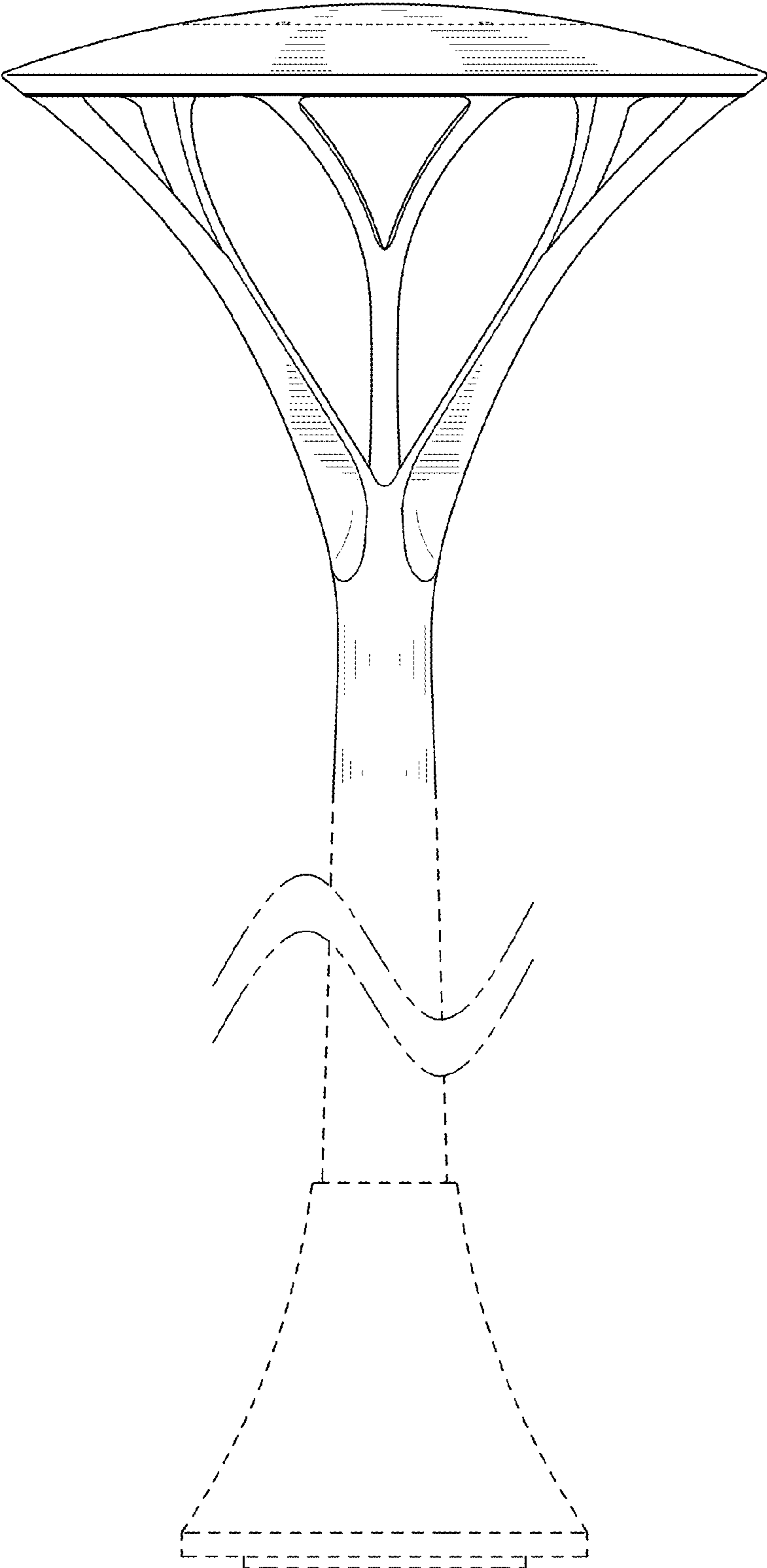

FIG. 11

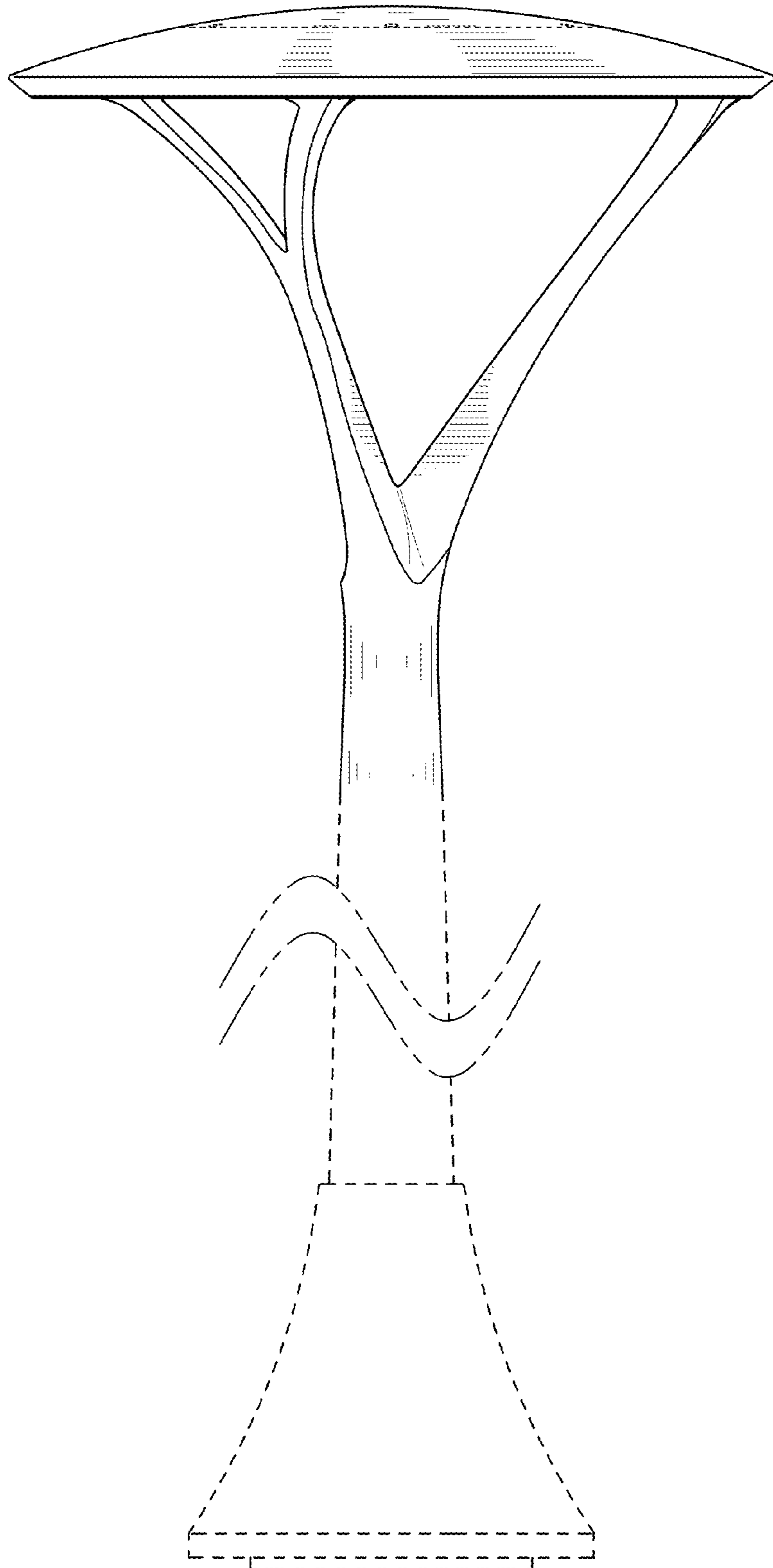

FIG. 12

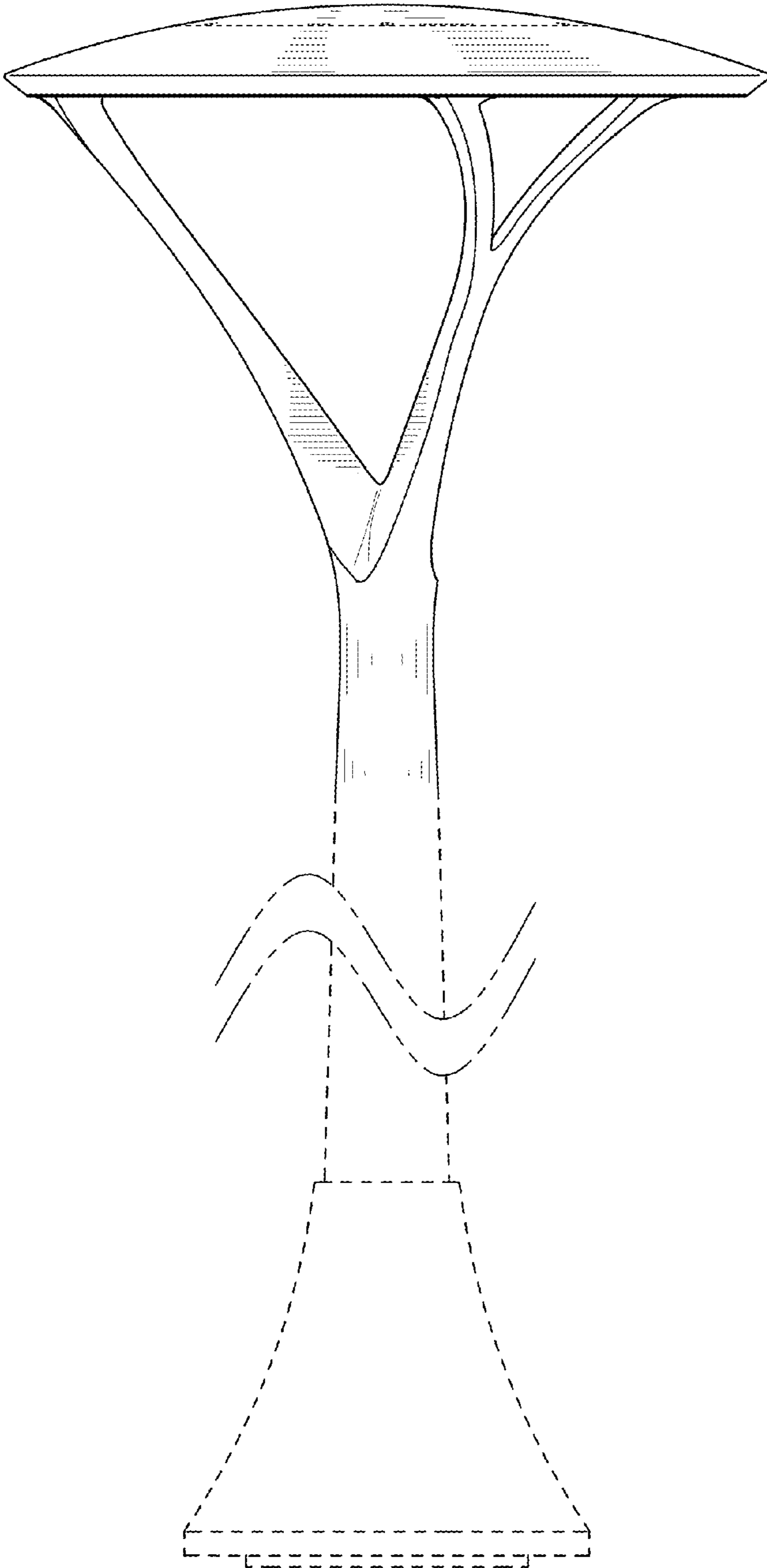

FIG. 13

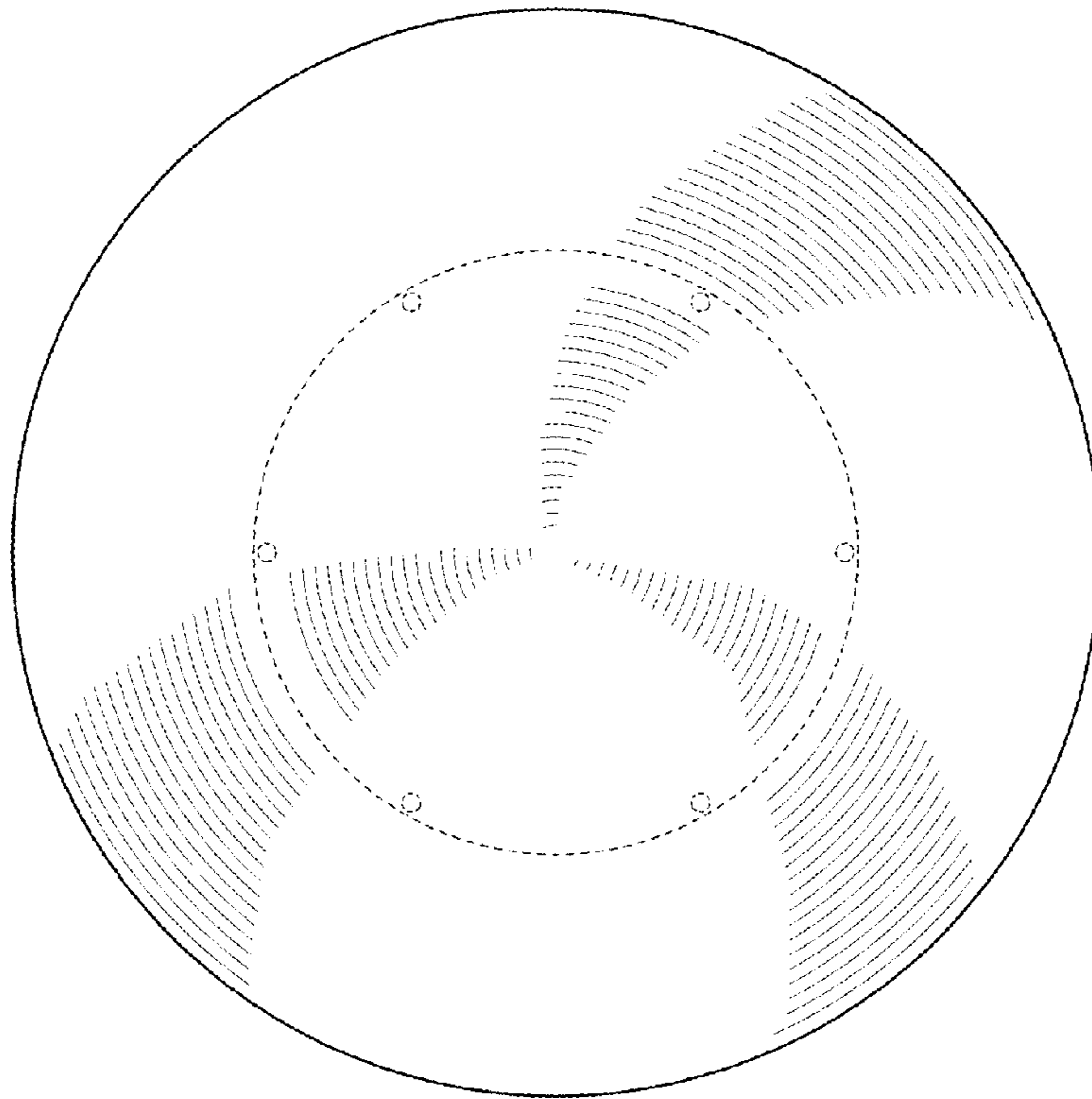

FIG. 14

