



US00D741465S

(12) **United States Design Patent**  
**Satou**

(10) **Patent No.:** **US D741,465 S**  
(45) **Date of Patent:** **\*\* Oct. 20, 2015**

(54) **AIR PURIFIER**

(56) **References Cited**

(71) Applicant: **Dai Satou**, Kusatsu (JP)

U.S. PATENT DOCUMENTS

(72) Inventor: **Dai Satou**, Kusatsu (JP)

D287,274 S *	12/1986	Crowley et al.	.....	D23/356
D299,528 S *	1/1989	Kessler et al.	.....	D23/351
D526,640 S *	8/2006	Chin et al.	.....	D14/188
D565,159 S *	3/2008	Shin et al.	.....	D23/356
D653,742 S *	2/2012	Satou	.....	D23/351
D688,362 S *	8/2013	Thomas et al.	.....	D23/356
D704,321 S *	5/2014	Jardine et al.	.....	D23/365
D705,410 S *	5/2014	Terao	.....	D23/364
D705,919 S *	5/2014	Park et al.	.....	D23/364
D728,089 S *	4/2015	Crisa'	.....	D23/366
D729,365 S *	5/2015	Yuan et al.	.....	D23/359
D733,273 S *	6/2015	Jeon et al.	.....	D23/333
D735,843 S *	8/2015	Sunwoo et al.	.....	D23/333

(73) Assignee: **DAIKIN INDUSTRIES LTD.**,  
Osaka-Shi, Osaka-Fu (JP)

(\*\*) Term: **14 Years**

(21) Appl. No.: **29/502,174**

(22) Filed: **Sep. 12, 2014**

\* cited by examiner

(30) **Foreign Application Priority Data**

Apr. 4, 2014 (JP) ..... 2014-007521

*Primary Examiner* — David Muller

(74) *Attorney, Agent, or Firm* — Manabu Kanesaka

(51) **LOC (10) Cl.** ..... **23-04**

(57) **CLAIM**

The ornamental design for an air purifier, as shown and described.

(52) **U.S. Cl.**

USPC ..... **D23/364**

**DESCRIPTION**

(58) **Field of Classification Search**

USPC ..... D23/355–366, 352, 369, 332, 333, 335,  
D23/336, 342, 351; 422/120, 122; 55/356,  
55/473, 504; 96/97; D14/188, 170, 172;  
261/DIG. 17, DIG. 65, DIG. 8, DIG. 31;  
D18/34.6

FIG. 1 is a perspective view of an air purifier showing my new design;  
FIG. 2 is a front elevation view thereof;  
FIG. 3 is a rear elevation view thereof;  
FIG. 4 is a top plan view thereof;  
FIG. 5 is a bottom plan view thereof;  
FIG. 6 is a left side elevation view thereof;  
FIG. 7 is a right side elevation view thereof; and,  
FIG. 8 is a cross-sectional view thereof along the line 8-8 in FIG. 2.

CPC ..... A61L 9/16; A61L 9/22; B01D 47/00;  
B01D 47/027; B01D 2221/02; B01D  
2259/4508; B03C 3/155; F24F 3/16; F24F  
13/20; F24F 13/28; F24F 2001/0096; F24F  
3/1405; F24F 3/1603; F24F 13/222

The broken lines depict portions of the air purifier that form no part of claimed design.

See application file for complete search history.

**1 Claim, 8 Drawing Sheets**

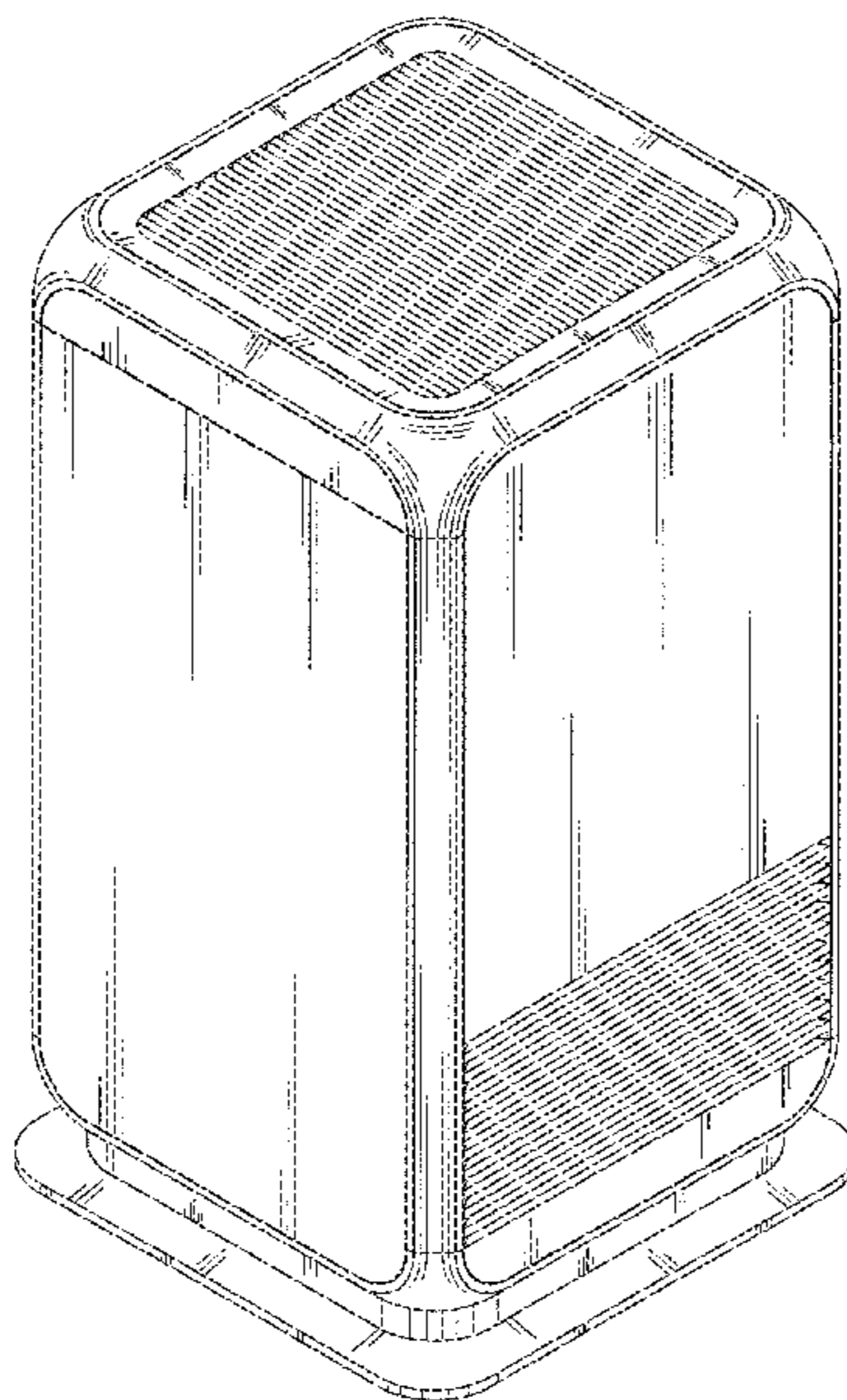

Fig.1

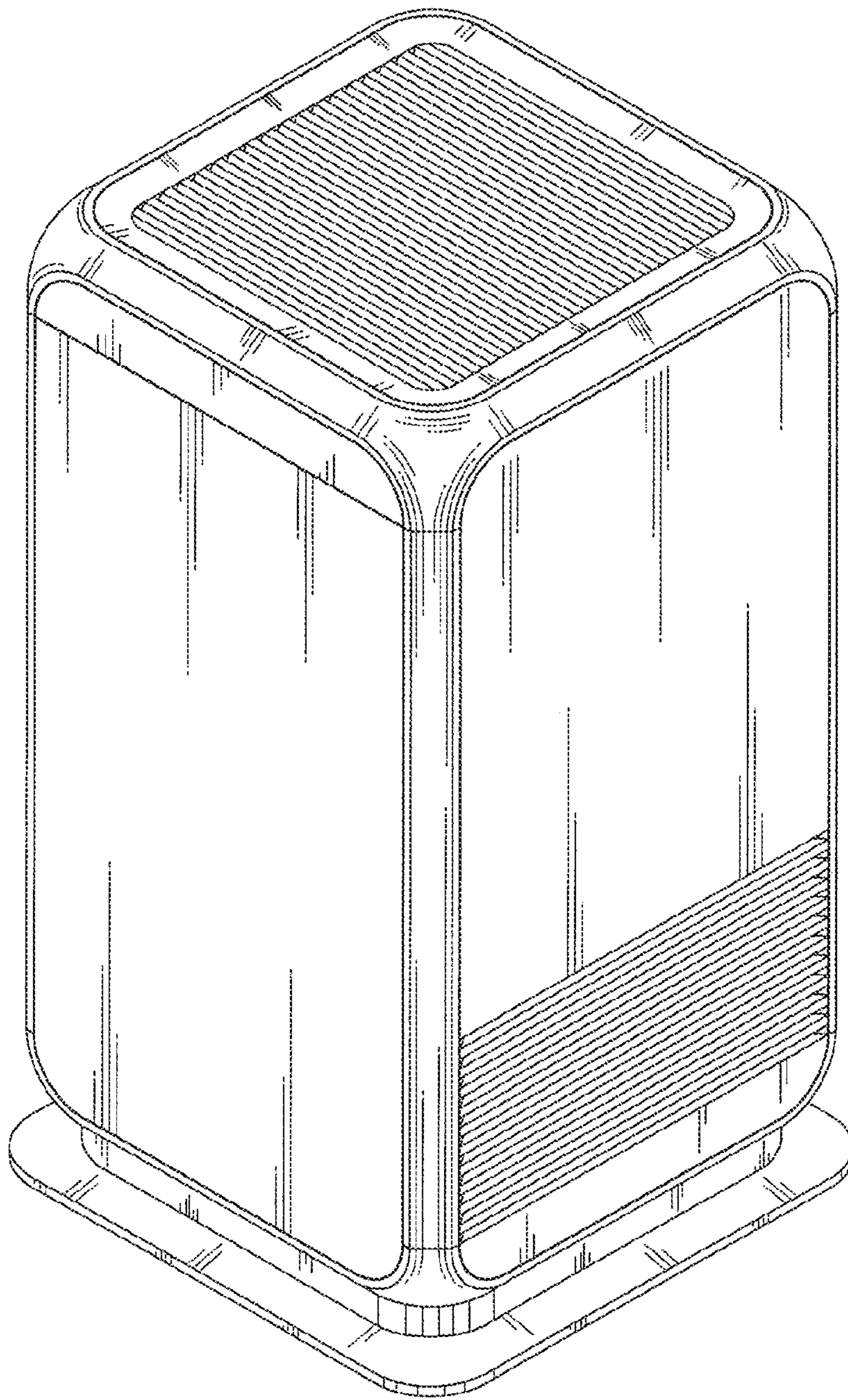
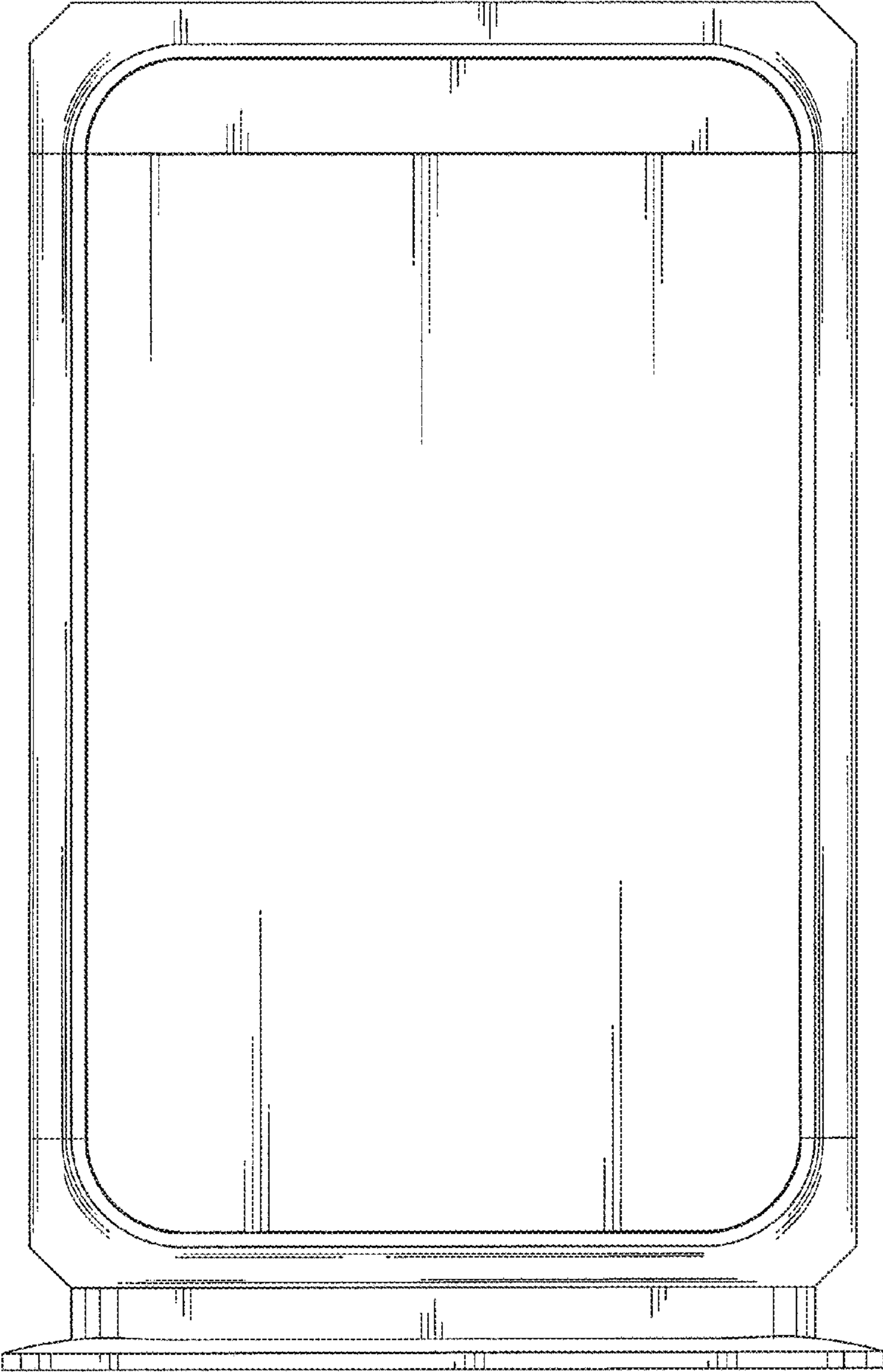

Fig.2

8 ←



8 ←

Fig.3

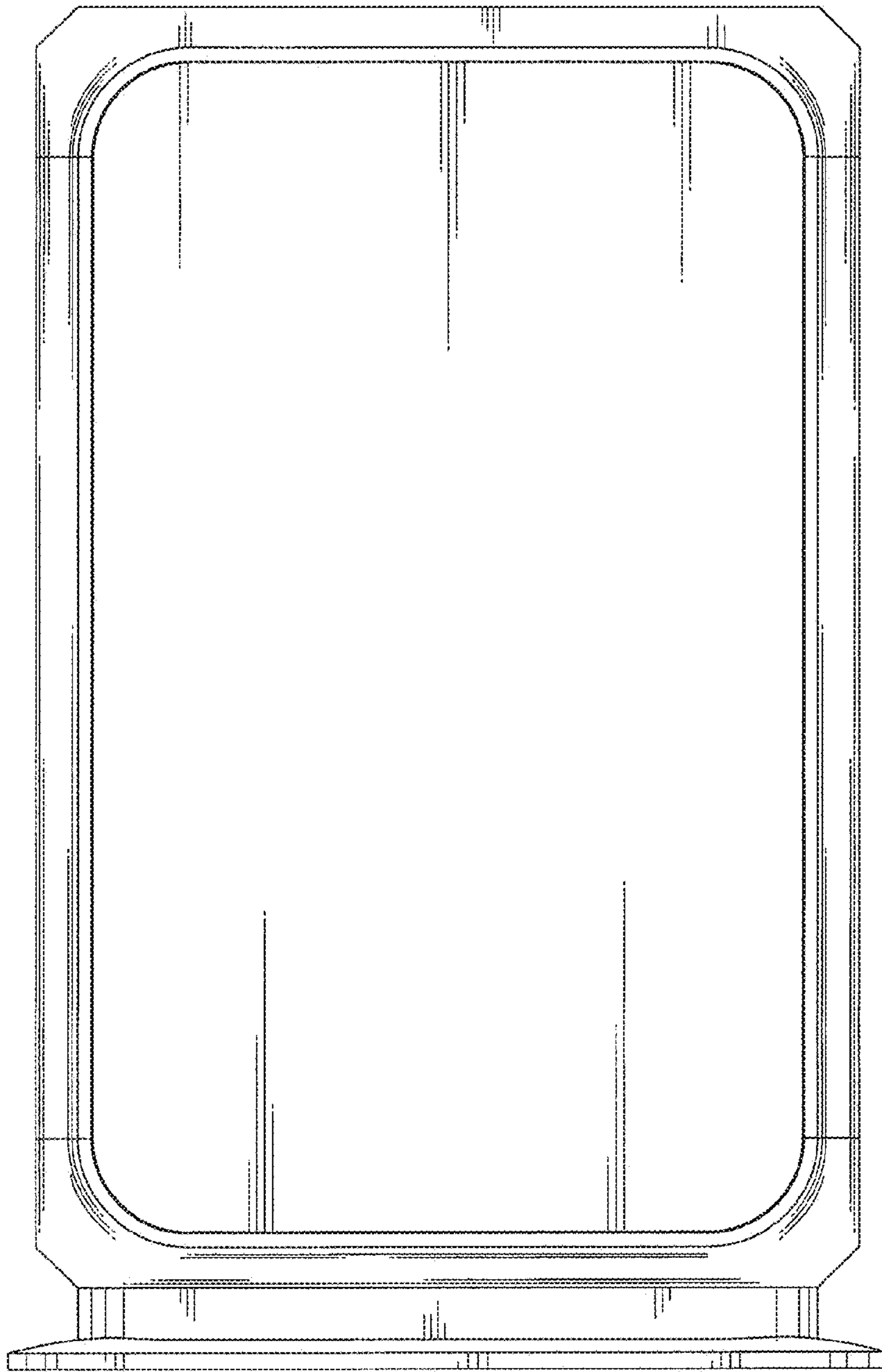

Fig.4

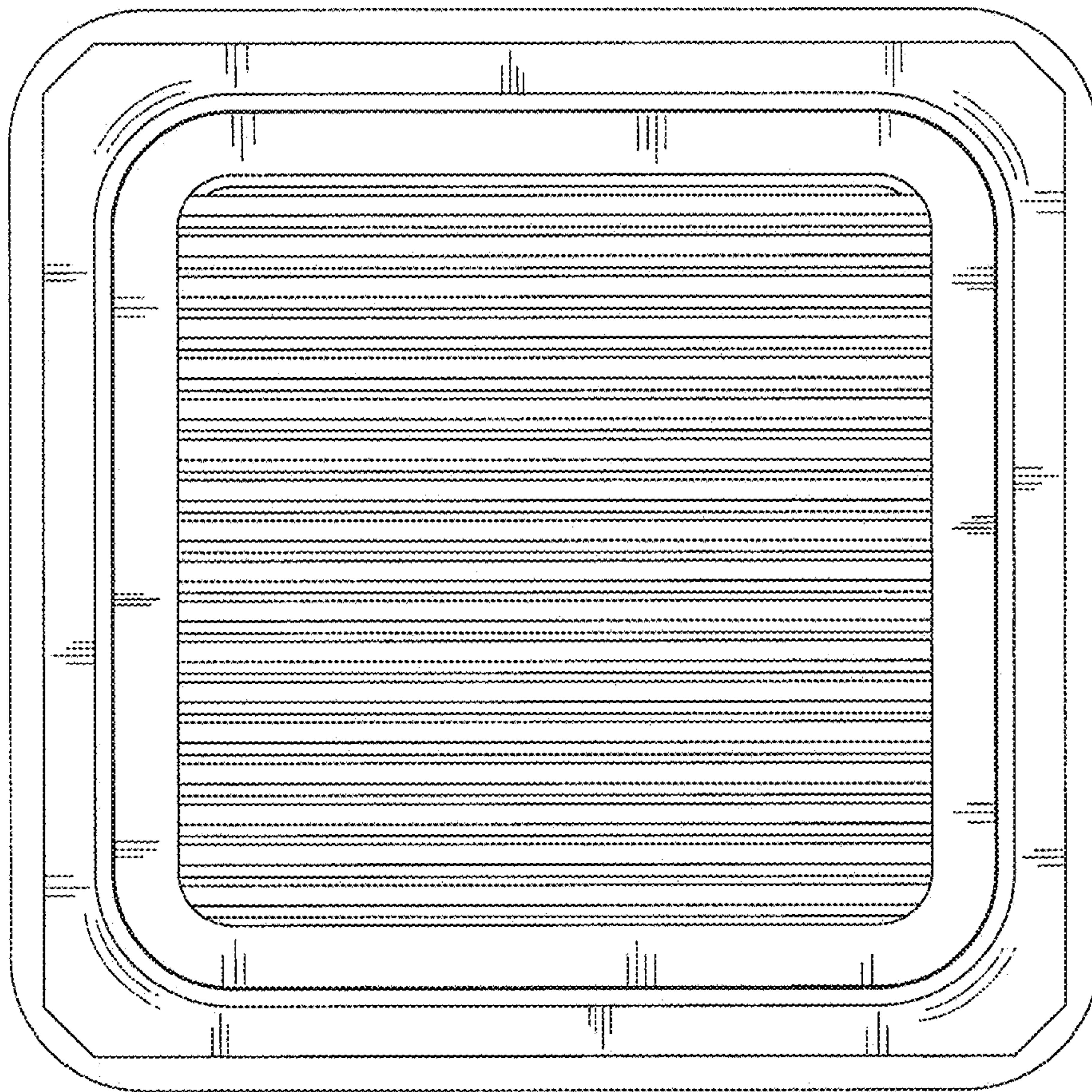

Fig.5

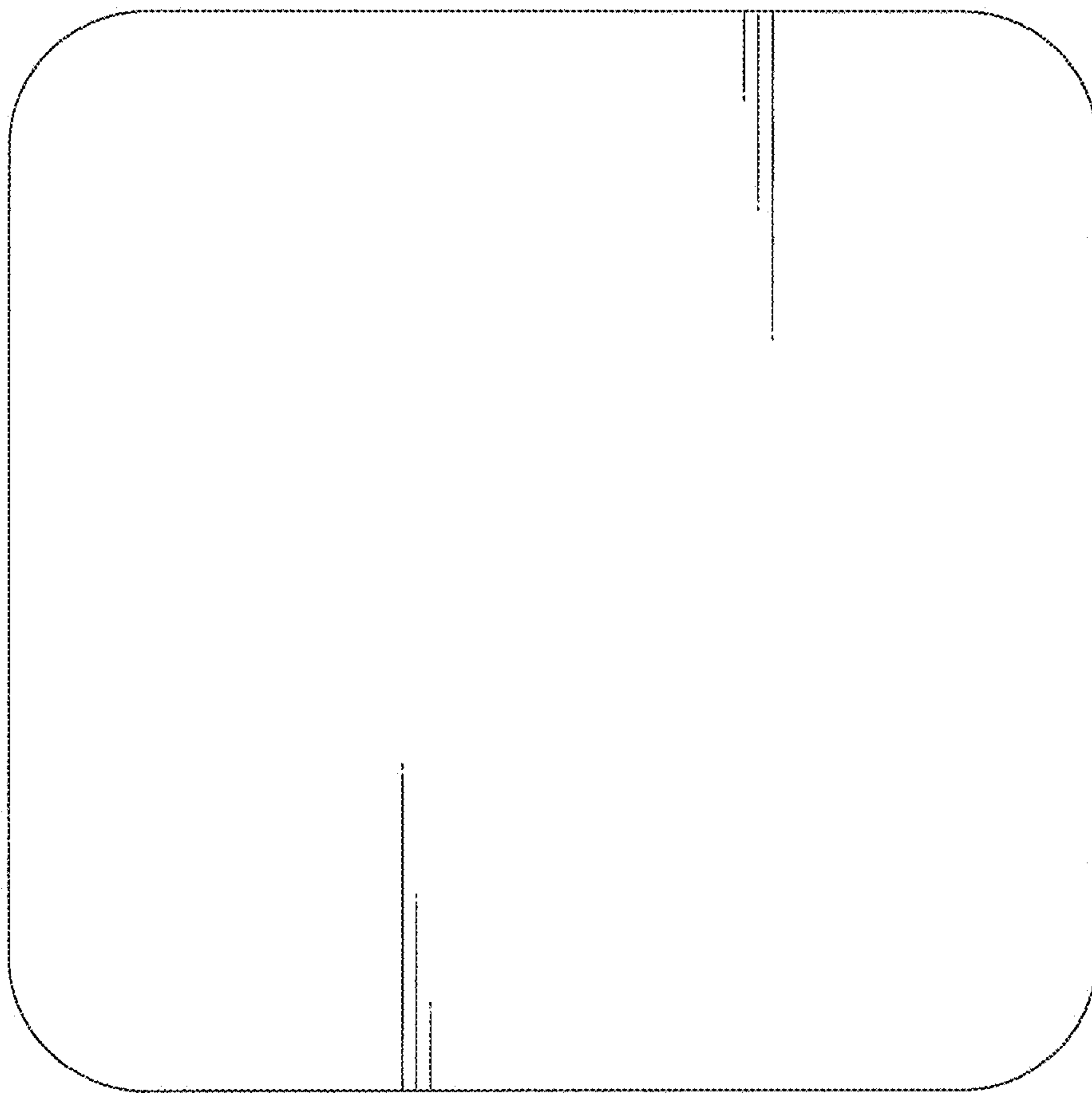

Fig.6

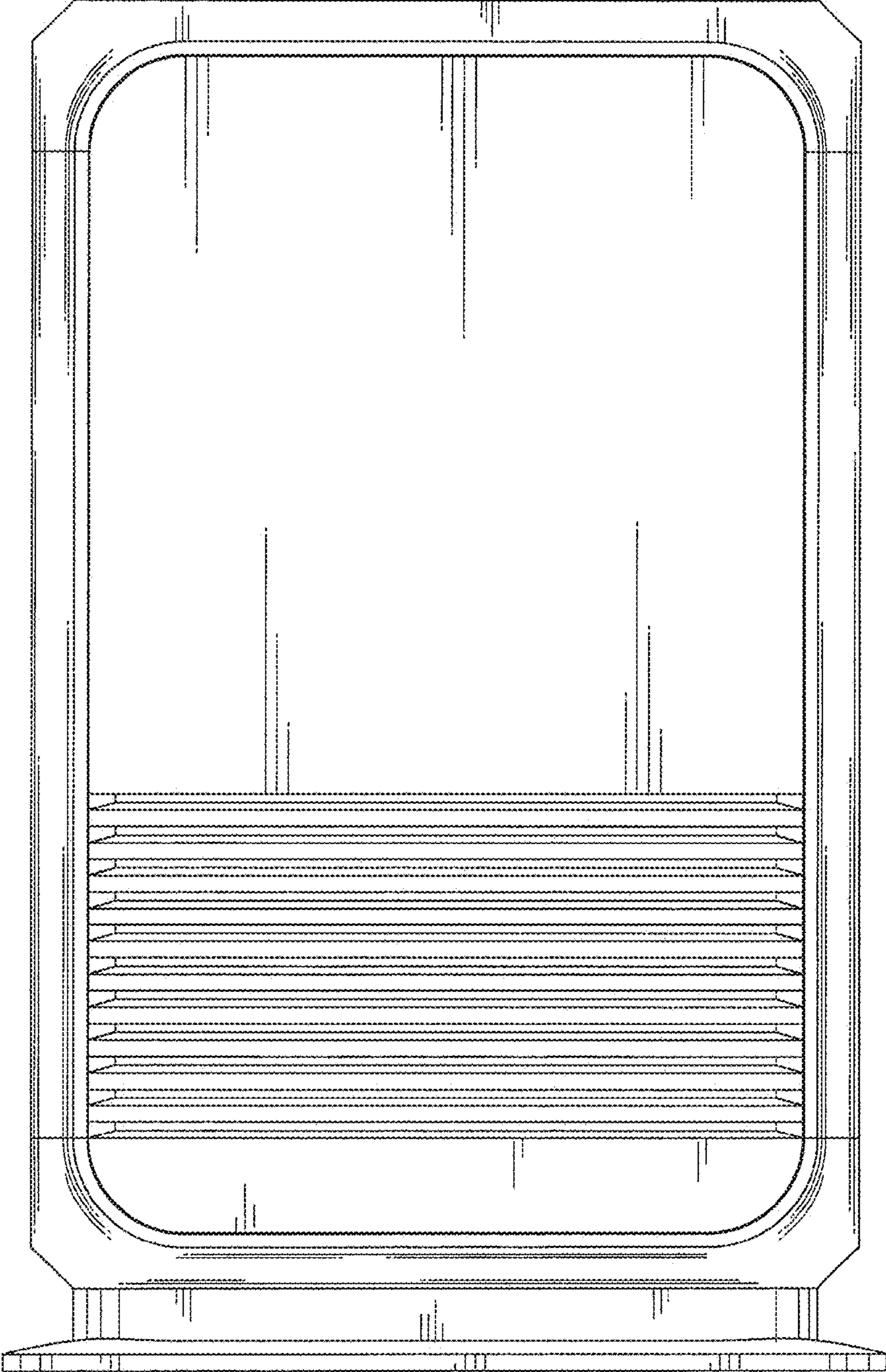

Fig.7

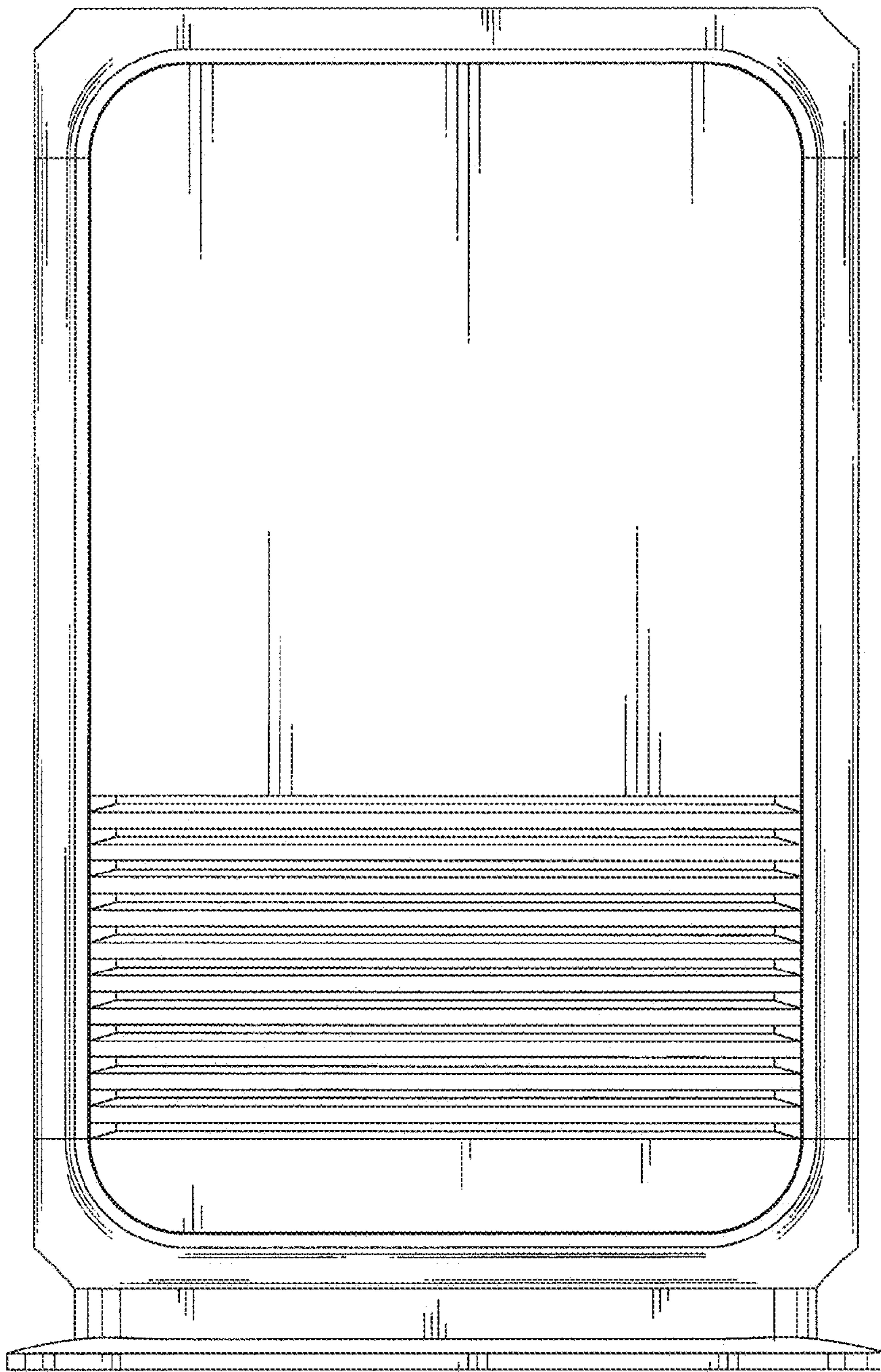



Fig.8

