



US00D741441S

(12) **United States Design Patent**
Gambill

(10) **Patent No.:** **US D741,441 S**

(45) **Date of Patent:** **** Oct. 20, 2015**

(54) **RIFLE STOCK**

(71) Applicant: **Bare G, LLC**, Millers Creek, NC (US)

(72) Inventor: **Ronald A. Gambill**, Millers Creek, NC (US)

(73) Assignee: **Bare G, LLC**, Millers Creek, NC (US)

(**) Term: **14 Years**

(21) Appl. No.: **29/483,064**

(22) Filed: **Feb. 25, 2014**

(51) **LOC (10) Cl.** **22-01**

(52) **U.S. Cl.**
USPC **D22/108**

(58) **Field of Classification Search**
USPC D22/103, 108; D21/572-573; 42/51,
42/90, 71.01, 71.02, 73, 75.01, 75.02;
362/160; 89/40.06, 37.04, 33.04;
33/334

CPC F41C 23/00; F41C 23/02; F41C 23/04;
F41C 23/06; F41C 23/08; F41C 23/10;
F41C 23/12; F41C 23/14; F41C 23/16;
F41C 23/18; F41C 23/20; F41C 23/22;
F41C 7/02; F41C 7/04; F41C 7/06; F41C
7/11; F41C 7/12

See application file for complete search history.

(56) **References Cited**

U.S. PATENT DOCUMENTS

D391,334 S * 2/1998 Plaster et al. D22/108
6,834,455 B2 12/2004 Burigana 42/74
D637,680 S * 5/2011 Peterson et al. D22/108

D649,202 S * 11/2011 En D21/573
D679,356 S 4/2013 Klotz D22/103
D722,672 S * 2/2015 Juarez D22/108
2005/0000142 A1 * 1/2005 Kim et al. 42/124

OTHER PUBLICATIONS

“The Fit of a Gun,” by Bob Spencer, 1999, home.insightbb.com.
“Stocky’s New Rifle Stocks,” StoreFront, www.stockysstocks.com,
2014.
Red Hawk Rifles; Bell and Carlson stocks retrieved from the interne
Feb. 26, 2014.

* cited by examiner

Primary Examiner — Michael A Pratt

(74) *Attorney, Agent, or Firm* — MacCord Mason PLLC

(57) **CLAIM**

The ornamental design for a rifle stock, as shown and described.

DESCRIPTION

FIG. 1 is a right side view of a rifle stock showing my new design;
FIG. 2 is a left side view thereof;
FIG. 3 is a top view thereof;
FIG. 4 is a bottom view thereof;
FIG. 5 is a rear view thereof;
FIG. 6 is a front view;
FIG. 7 is a perspective view; and,
FIG. 8 is an environmental view showing a user holding a rifle.

The dotted lines shown in FIG. 8 are for environmental purposes and form no part of the claimed design.

1 Claim, 8 Drawing Sheets

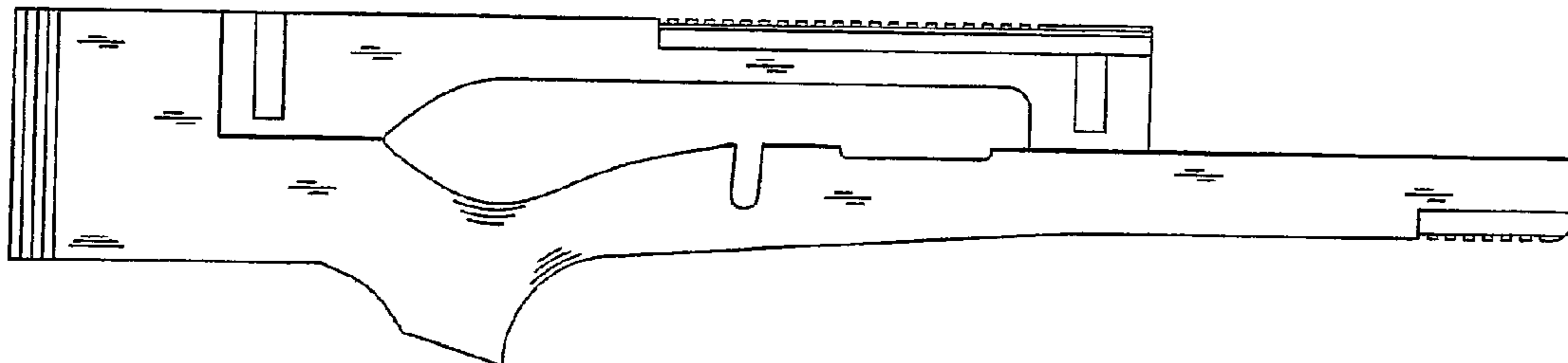

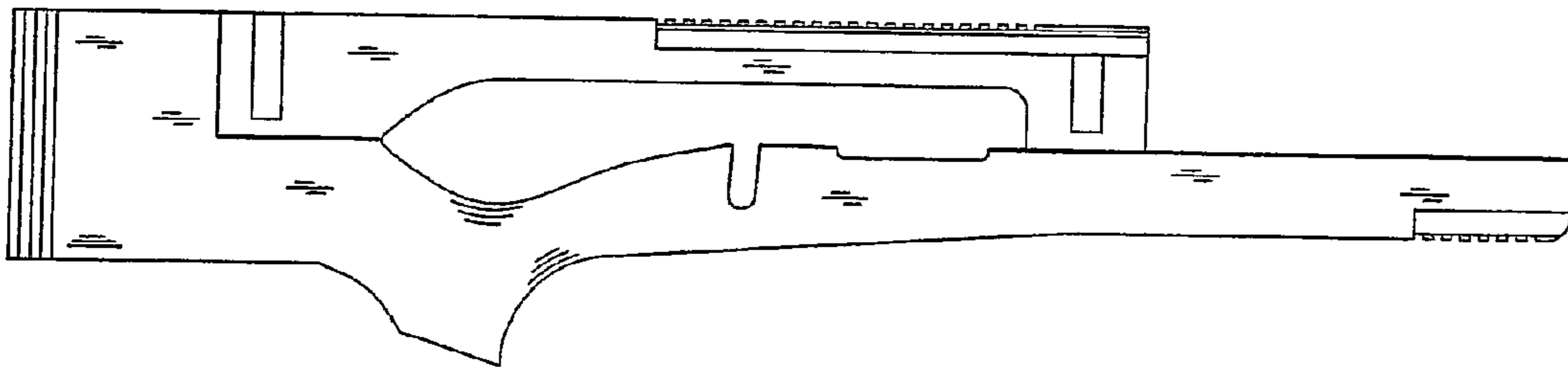

Fig 1

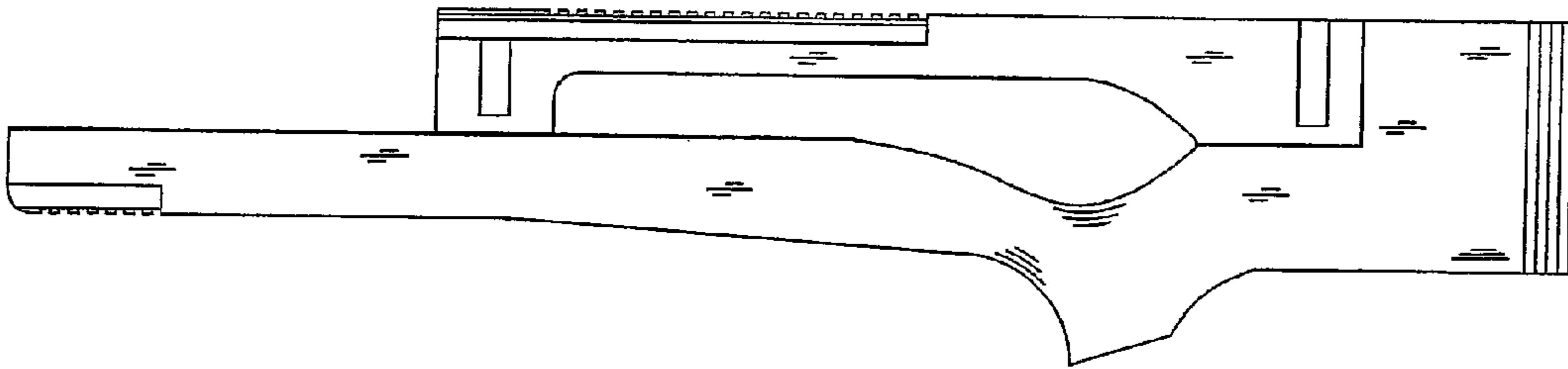

Fig 2



Fig 3



Fig 4

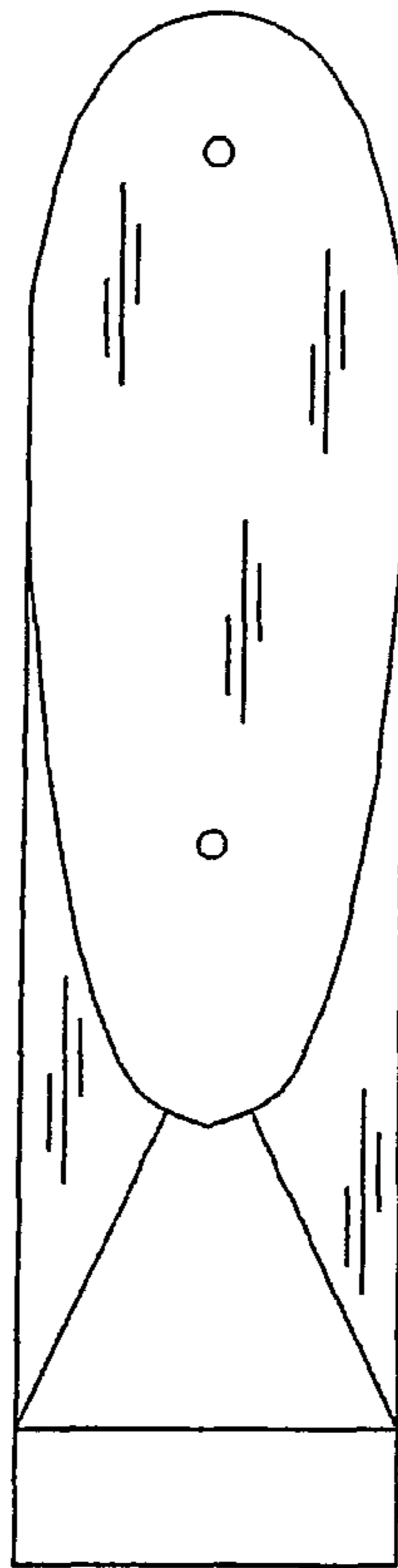

Fig 5

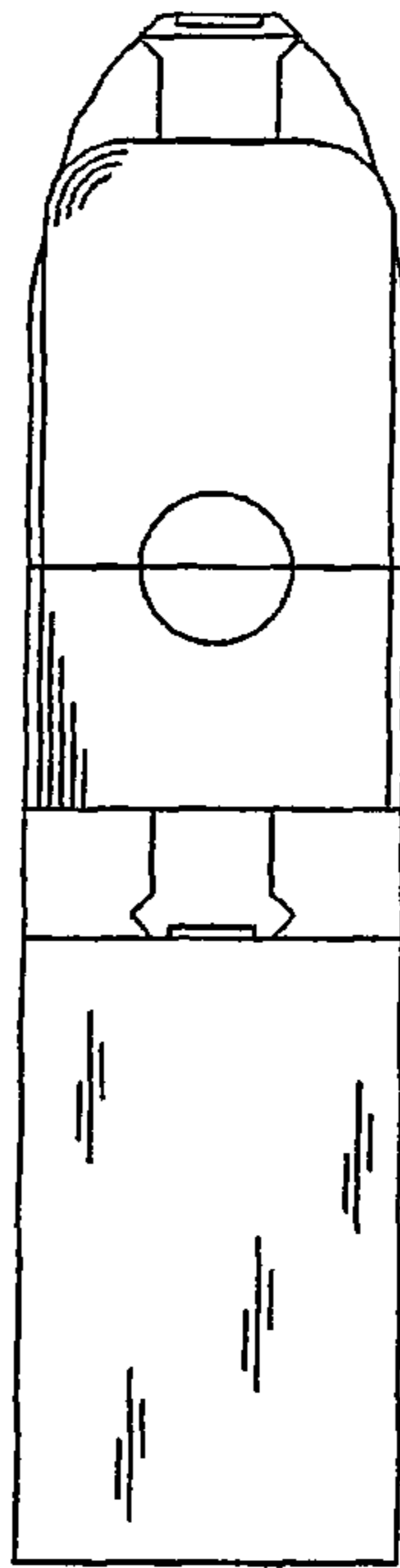

Fig 6

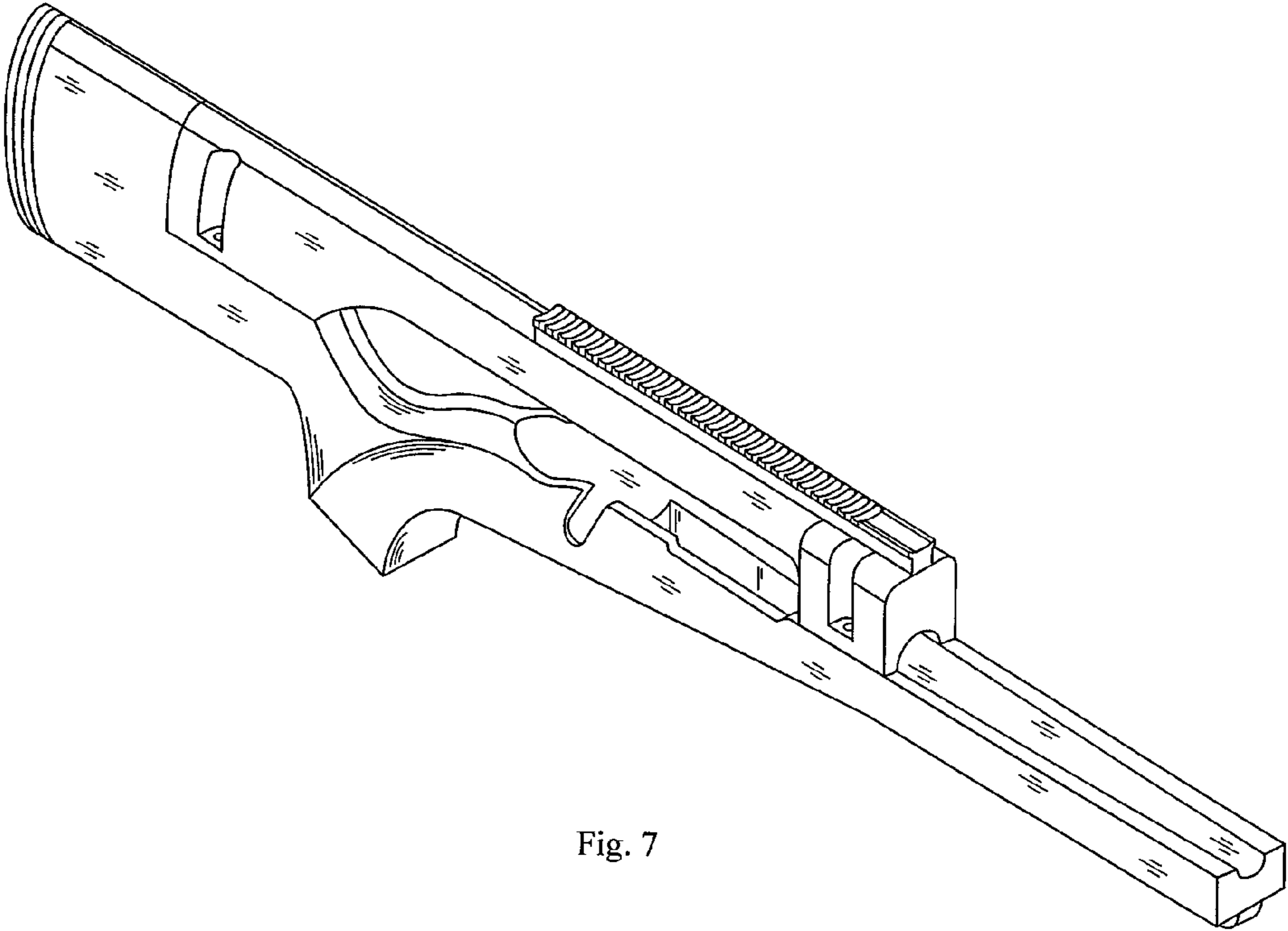

Fig. 7

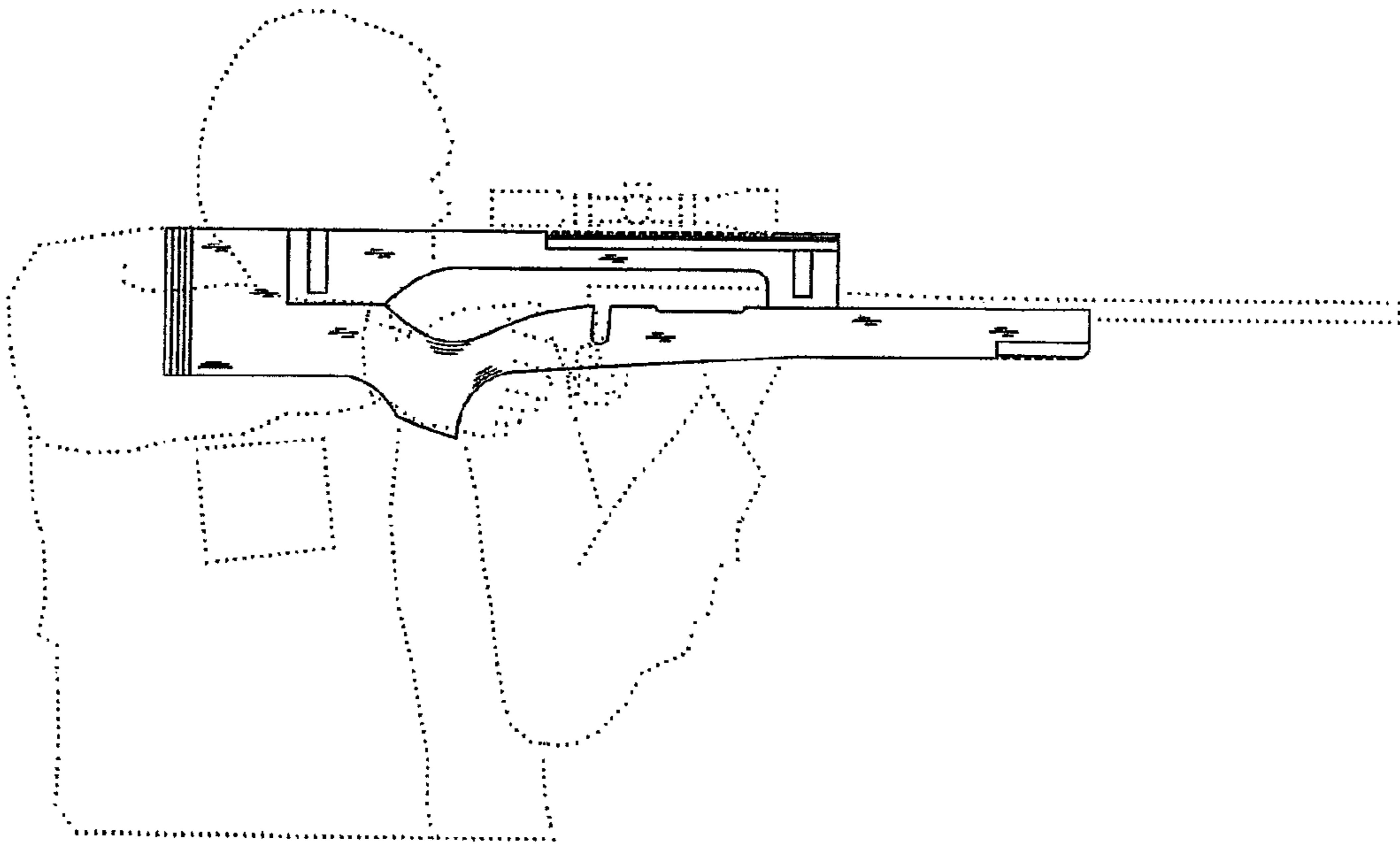

Fig 8