



US00D741217S

(12) **United States Design Patent**  
**Kernahan**

(10) **Patent No.:** **US D741,217 S**

(45) **Date of Patent:** **\*\* Oct. 20, 2015**

(54) **PLANT GROWING SYSTEM**

(71) Applicant: **AESSENCE CORPORATION**,  
Mountain View, CA (US)

(72) Inventor: **Kent Kernahan**, Cupertino, CA (US)

(73) Assignee: **Aessense Technology Hong Kong Limited**, Hong Kong (CN)

(\*\*) Term: **14 Years**

(21) Appl. No.: **29/497,355**

(22) Filed: **Jul. 23, 2014**

(51) **LOC (10) Cl.** ..... **11-02**

(52) **U.S. Cl.**  
USPC ..... **D11/155**

(58) **Field of Classification Search**  
USPC ..... D3/304; D6/403-405, 675, 683;  
D9/425, 428; D11/143-156, 164;  
D25/15  
CPC ..... A01G 9/00; A01G 9/02; A01G 9/021;  
A01G 9/022; A01G 9/024; A01G 9/10;  
A01G 9/04; A01G 9/042; A01G 9/14; A01G  
9/16; A01G 31/02; B65D 33/02  
See application file for complete search history.

(56) **References Cited**

**U.S. PATENT DOCUMENTS**

3,152,574 A \* 10/1964 Stout ..... 119/269  
4,175,513 A \* 11/1979 Roehrick ..... 119/246

4,176,620 A \* 12/1979 Kassos ..... 119/246  
4,189,867 A \* 2/1980 Schneck ..... 47/62 R  
5,363,801 A \* 11/1994 Watters et al. .... 119/452  
6,035,578 A \* 3/2000 Lo et al. .... 47/61  
7,426,802 B2 \* 9/2008 Umbaugh, Jr. .... 47/62 R  
2003/0097789 A1 \* 5/2003 Corbesier et al. .... 47/64  
2007/0113472 A1 \* 5/2007 Plowman ..... 47/62 A  
2014/0338261 A1 \* 11/2014 Sykes ..... 47/62 A  
2015/0007497 A1 \* 1/2015 Delp, II ..... 47/66.7

\* cited by examiner

*Primary Examiner* — Elizabeth Albert

(74) *Attorney, Agent, or Firm* — David Millers

(57) **CLAIM**

The ornamental design for a plant growing system, as shown and described.

**DESCRIPTION**

FIG. 1 is a front perspective view of a plant growing system showing my new design;  
FIG. 2 is a front elevation view thereof;  
FIG. 3 is a rear elevation view thereof;  
FIG. 4 is a right side elevation view thereof;  
FIG. 5 is a left side elevation view thereof;  
FIG. 6 is a top plan view thereof; and,  
FIG. 7 is a bottom plan view thereof.  
The features shown in broken lines are included for the purpose of showing portions of the plant growing system that form no part of the claimed design.

**1 Claim, 7 Drawing Sheets**

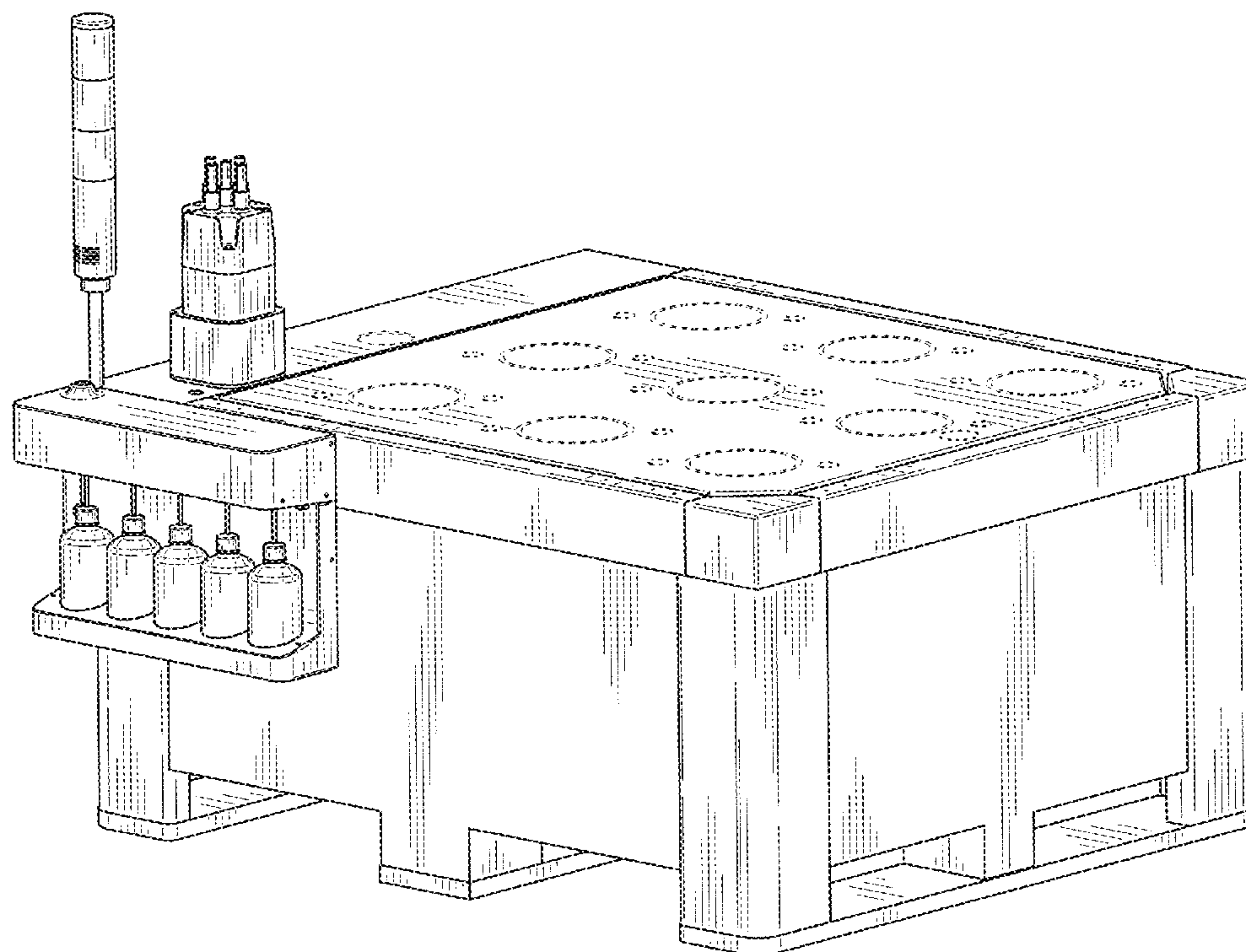

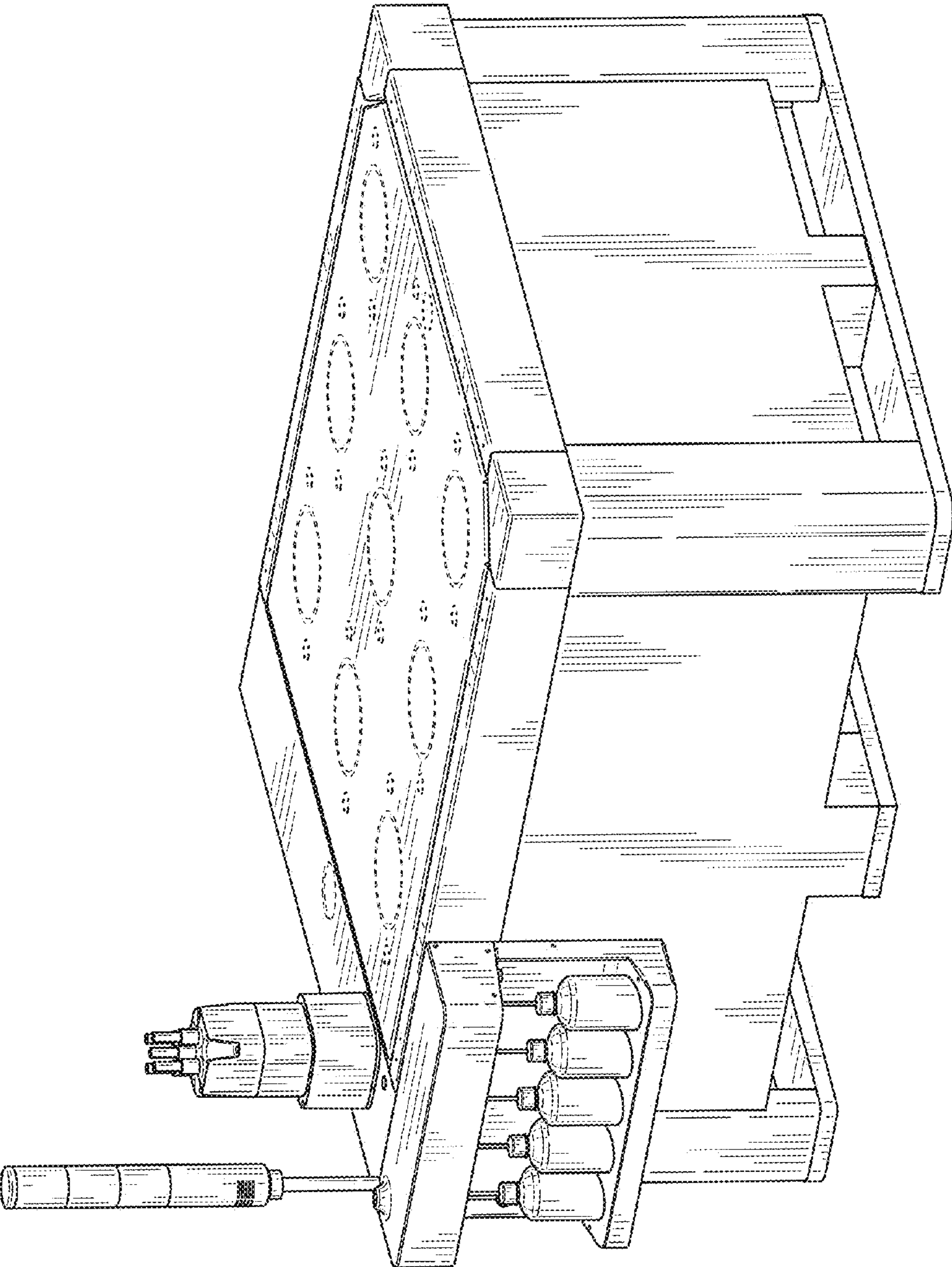

FIG. 1

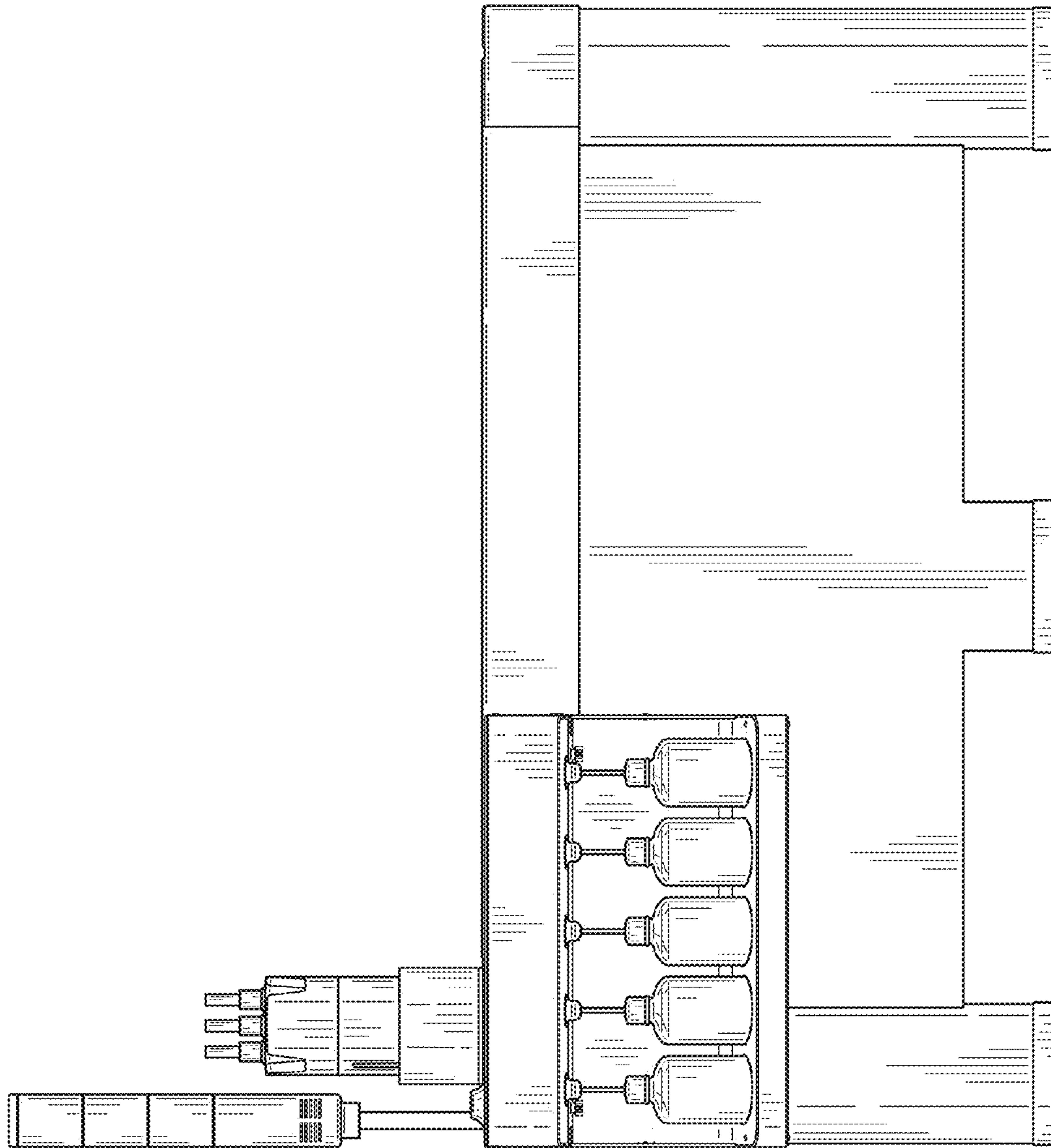

FIG. 2

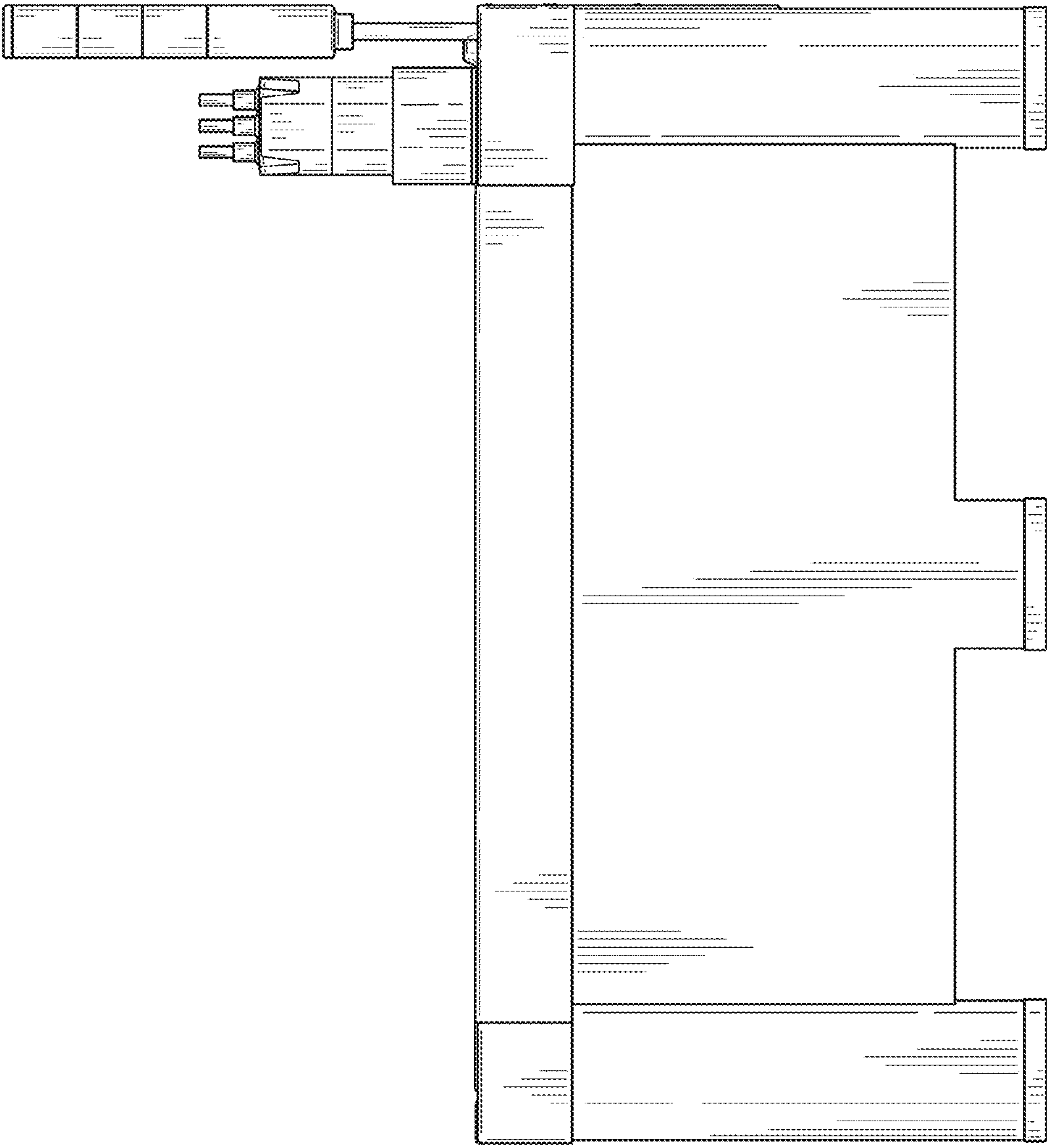

FIG. 3



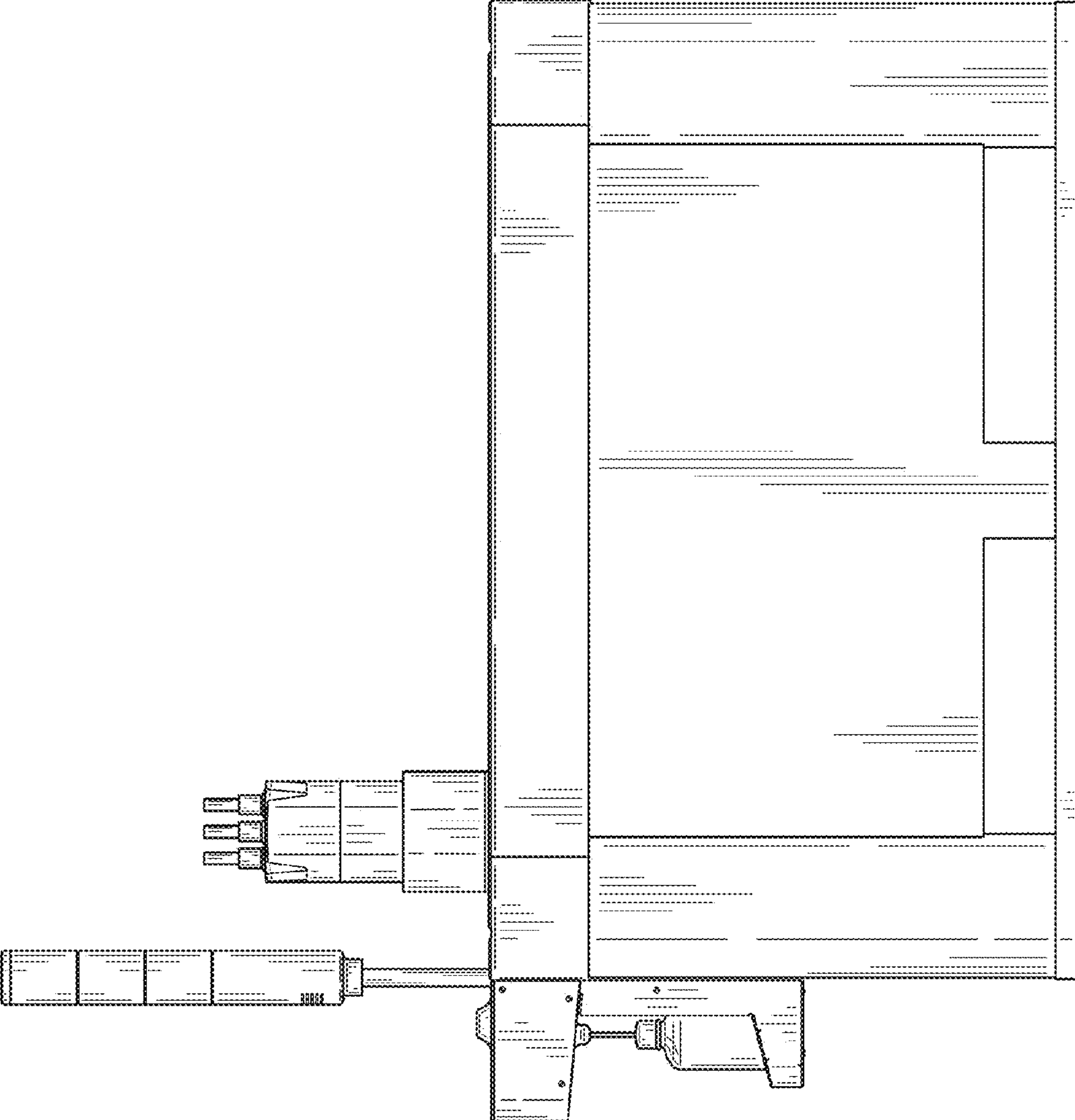

FIG. 4

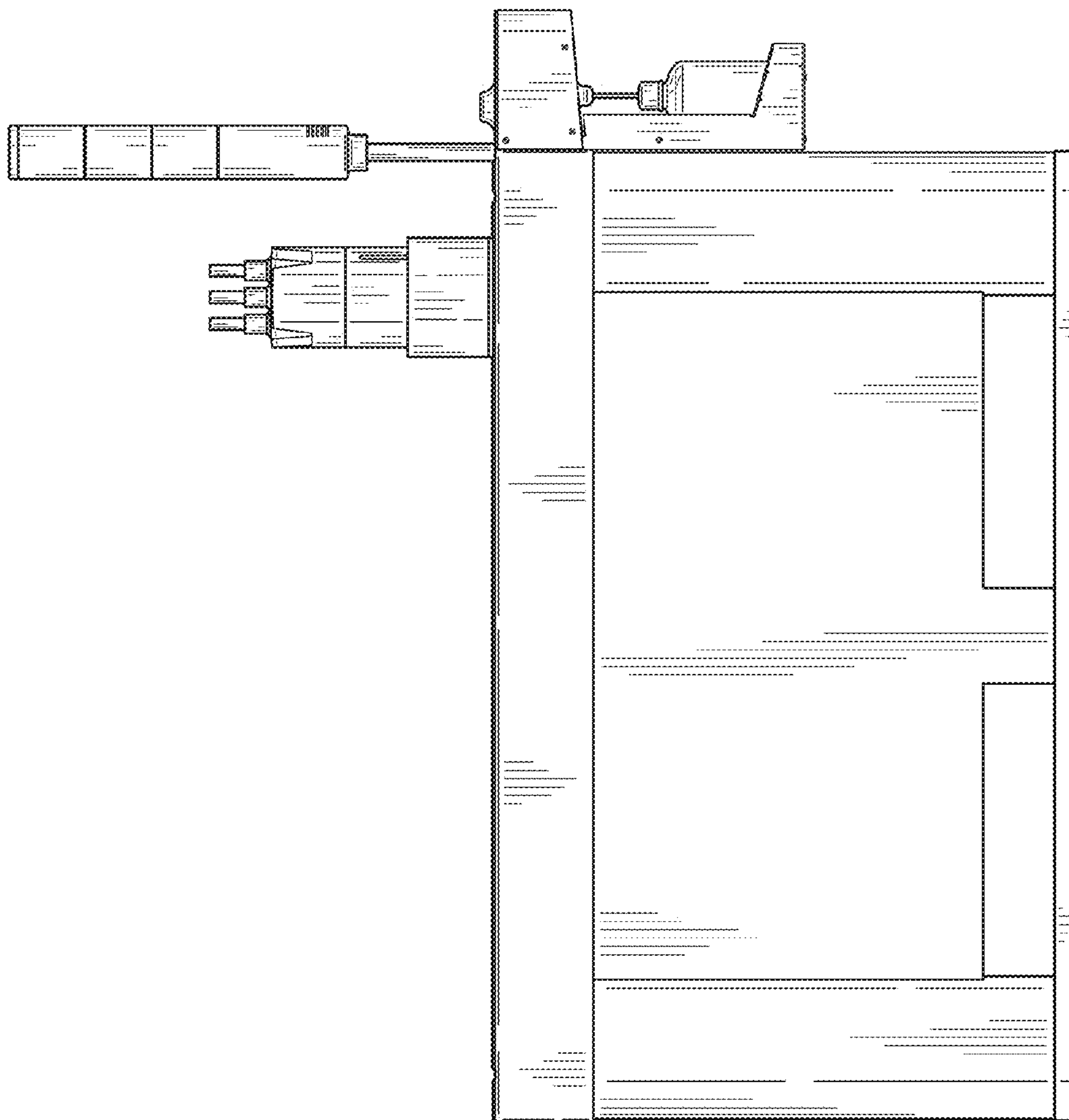

FIG. 5

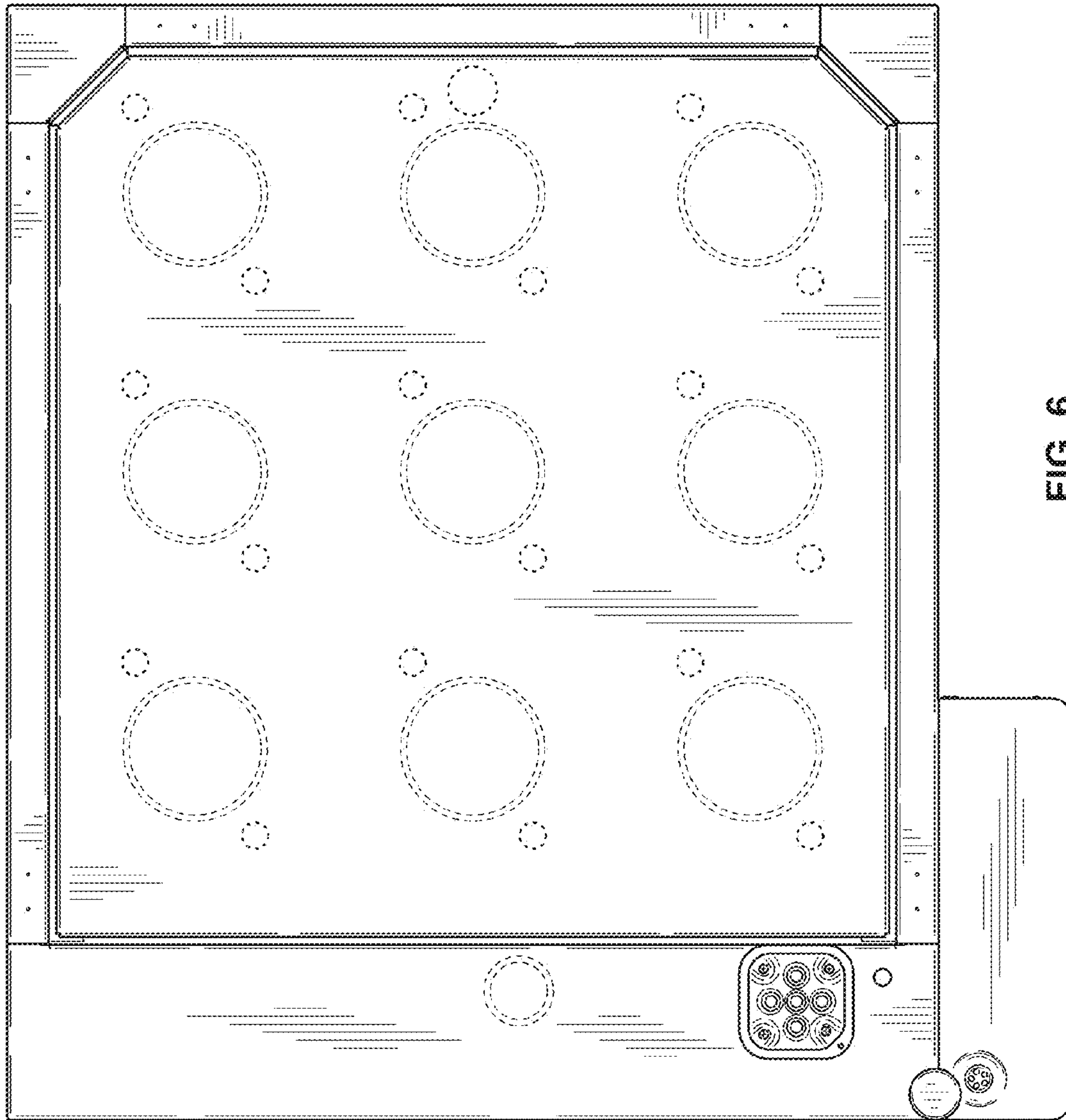

FIG. 6

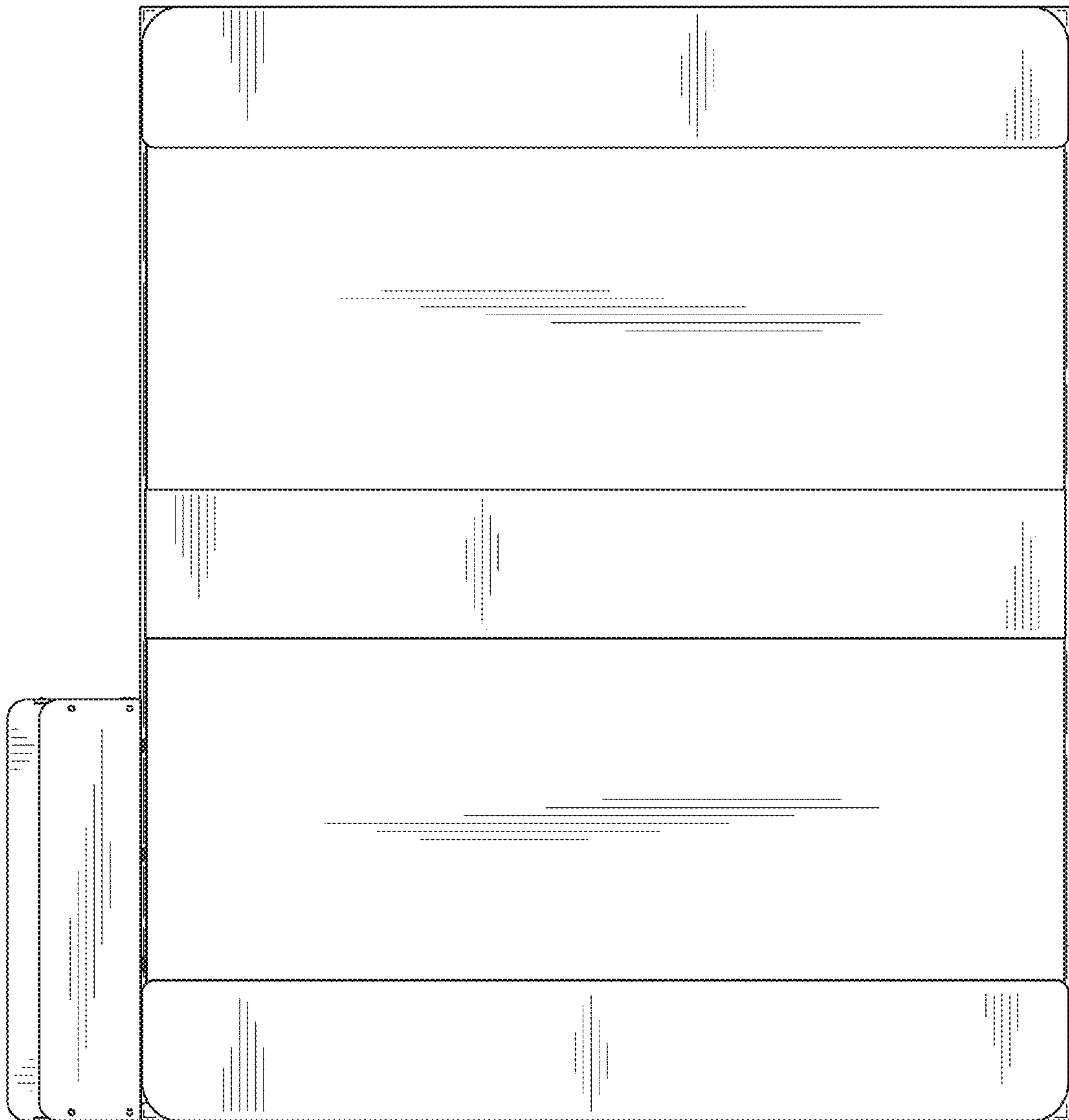

FIG. 7