



US00D741207S

(12) **United States Design Patent**
Jones

(10) **Patent No.:** **US D741,207 S**
(45) **Date of Patent:** **** Oct. 20, 2015**

(54) **HOLDER FOR A MEASURING TAPE**

(71) Applicant: **Lee Valley Tools Ltd.**, Ottawa, Ontario
(CA)

(72) Inventor: **Steven K. Jones**, Ottawa (CA)

(73) Assignee: **Lee Valley Tools Ltd.**, Ottawa, Ontario
(CA)

(**) Term: **14 Years**

(21) Appl. No.: **29/494,279**

(22) Filed: **Jun. 19, 2014**

(51) **LOC (10) Cl.** **10-04**

(52) **U.S. Cl.**
USPC **D10/74**

(58) **Field of Classification Search**
USPC D10/74
CPC G01B 3/1041; G01B 2003/1043;
G01B 2003/1046; G01B 2003/1048; G01B
2003/1051; G01B 2003/1053; G01B 3/1071;
G01B 2003/1074; G01B 2003/1076; G01B
2003/1079; G01B 3/1084; G01B 2003/1087;
G01B 2003/1089; G01B 2003/109
See application file for complete search history.

(56) **References Cited**

U.S. PATENT DOCUMENTS

5,388,741 A * 2/1995 Hillinger 224/679
D553,027 S * 10/2007 Weich et al. D10/74
D566,590 S * 4/2008 Stevens et al. D10/74
2006/0261116 A1 * 11/2006 Brandeis 224/671

2009/0044419 A1 * 2/2009 Lee et al. 33/769
2009/0217541 A1 * 9/2009 Lee et al. 33/761
2011/0138644 A1 * 6/2011 Smith 33/767

* cited by examiner

Primary Examiner — Antoine D Davis

(74) *Attorney, Agent, or Firm* — Kilpatrick Townsend &
Stockton LLP; John S. Pratt; Megan E. Bussey

(57) **CLAIM**

The ornamental design for a holder for a measuring tape, as shown and described.

DESCRIPTION

FIG. 1 is a perspective view of the holder for a measuring tape of this invention.

FIG. 2 is a top view of the holder for a measuring tape shown in FIG. 1.

FIG. 3 is a bottom view of the holder for a measuring tape shown in FIG. 1.

FIG. 4 is a left side view of the holder for a measuring tape shown in FIG. 1.

FIG. 5 is a right side view of the holder for a measuring tape shown in FIG. 1.

FIG. 6 is a rear view of the holder for a measuring tape shown in FIG. 1.

FIG. 7 is a front view of the holder for a measuring tape shown in FIG. 1; and,

FIG. 8 is the perspective view of the holder of FIG. 1 with a measuring tape shown in broken lines.

The portions of the figures shown in broken lines form no part of the claimed design.

1 Claim, 6 Drawing Sheets

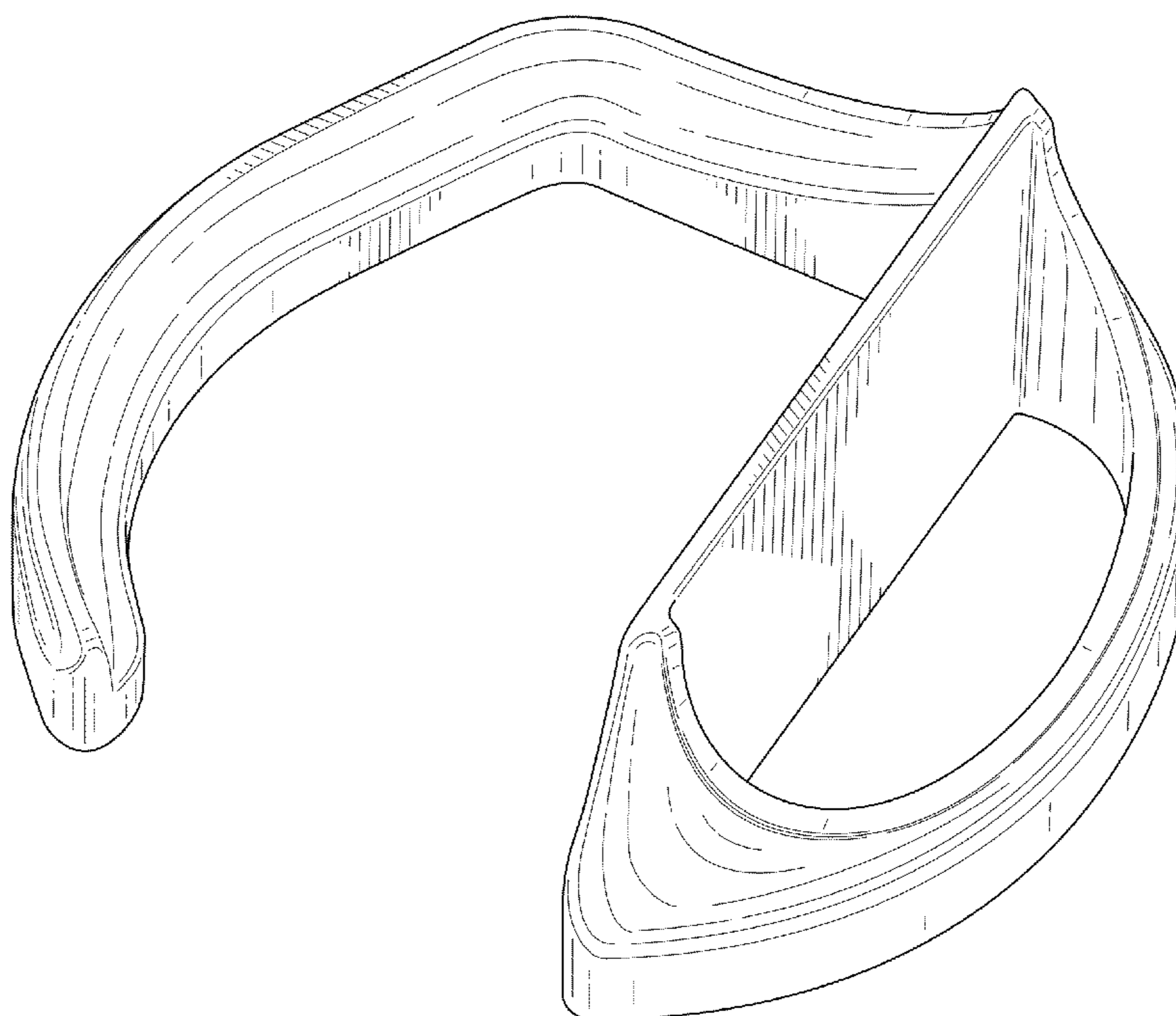

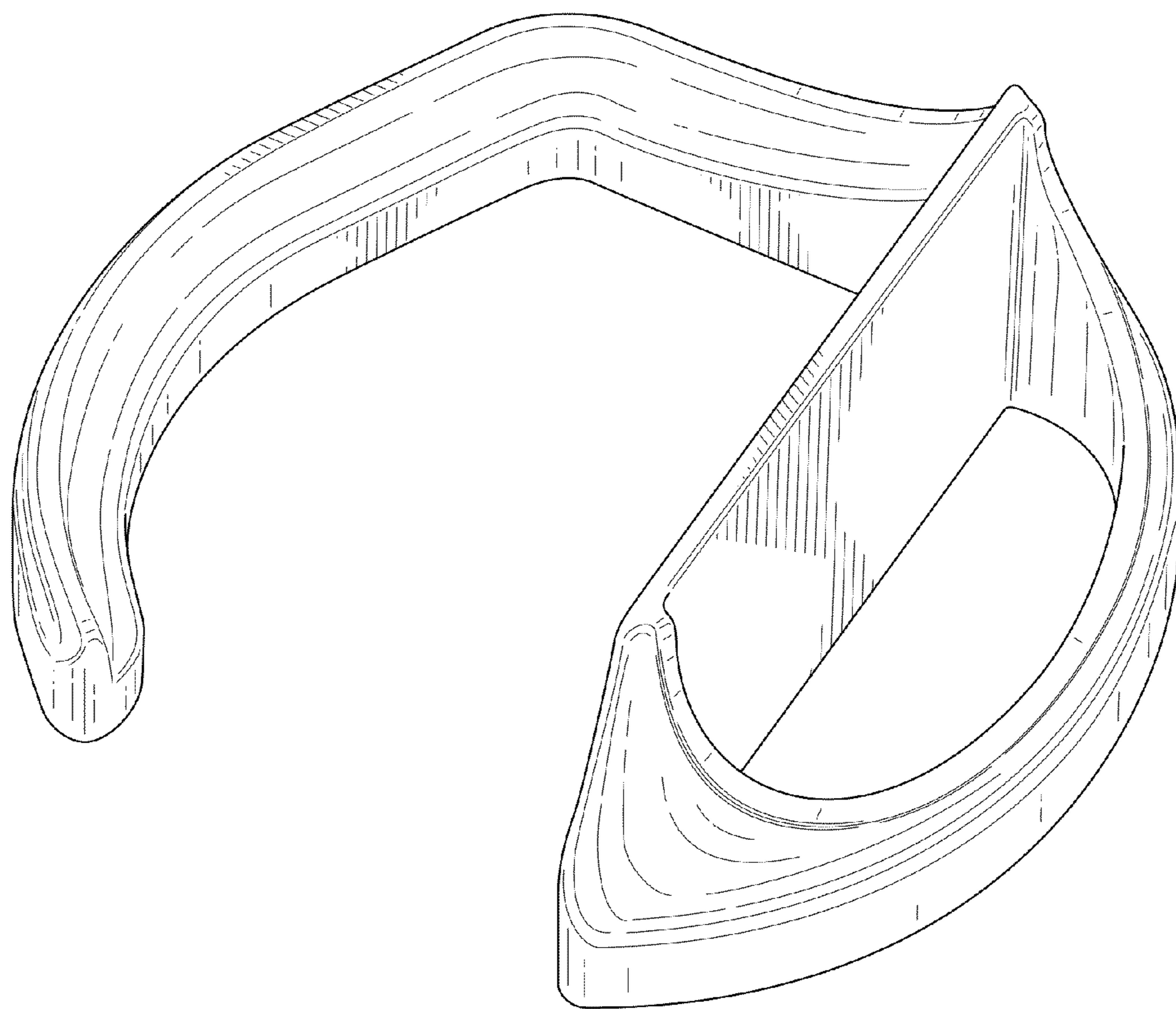

FIG. 1

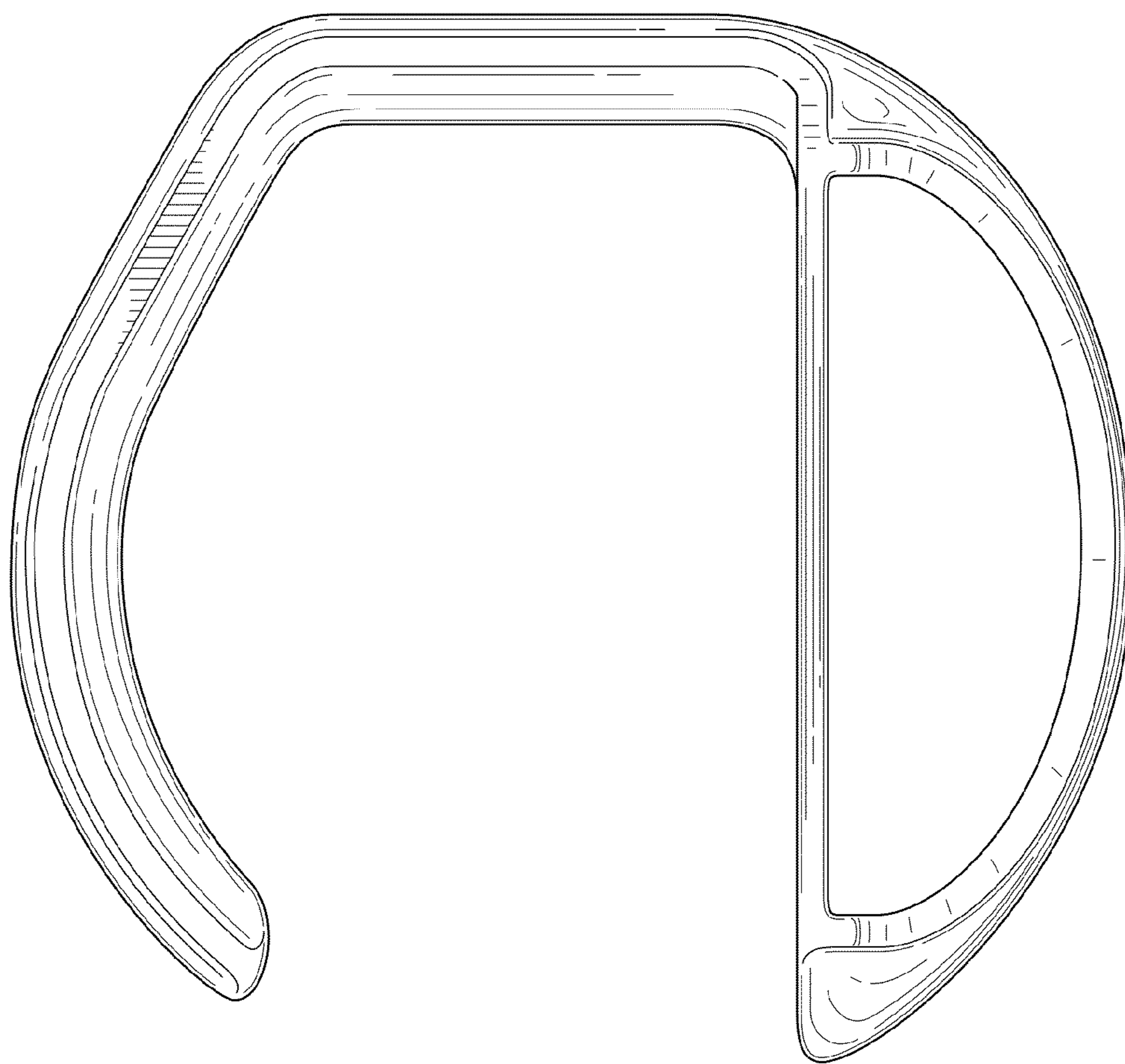

FIG. 2

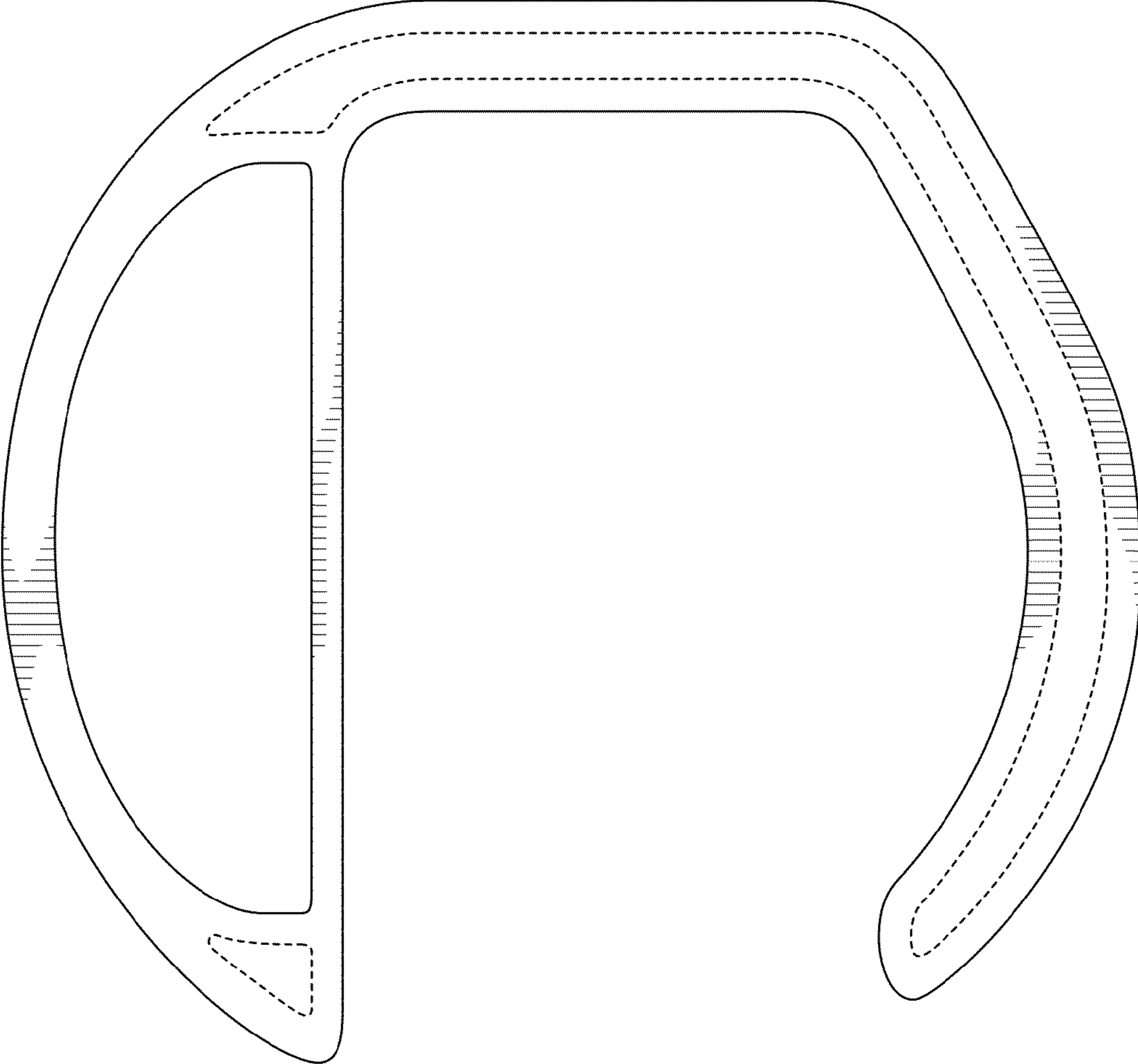

FIG. 3

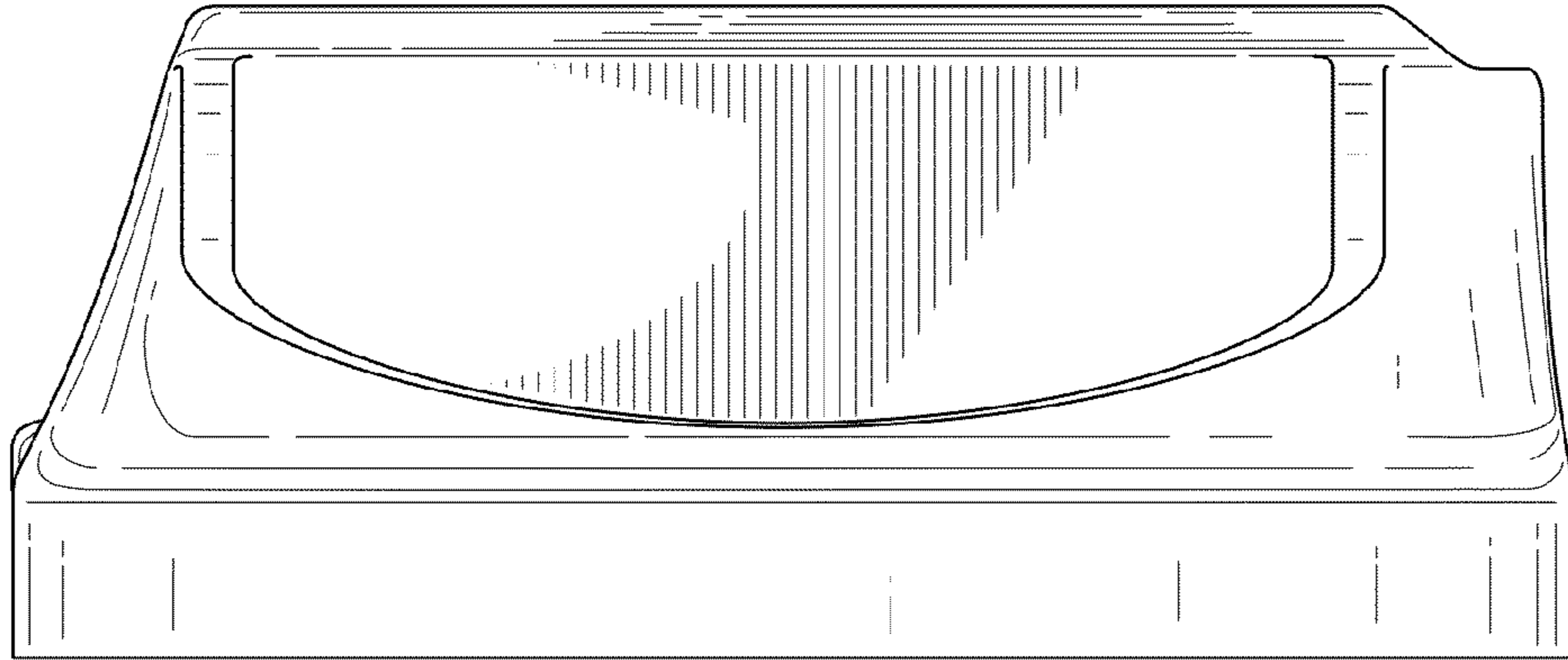

FIG. 4

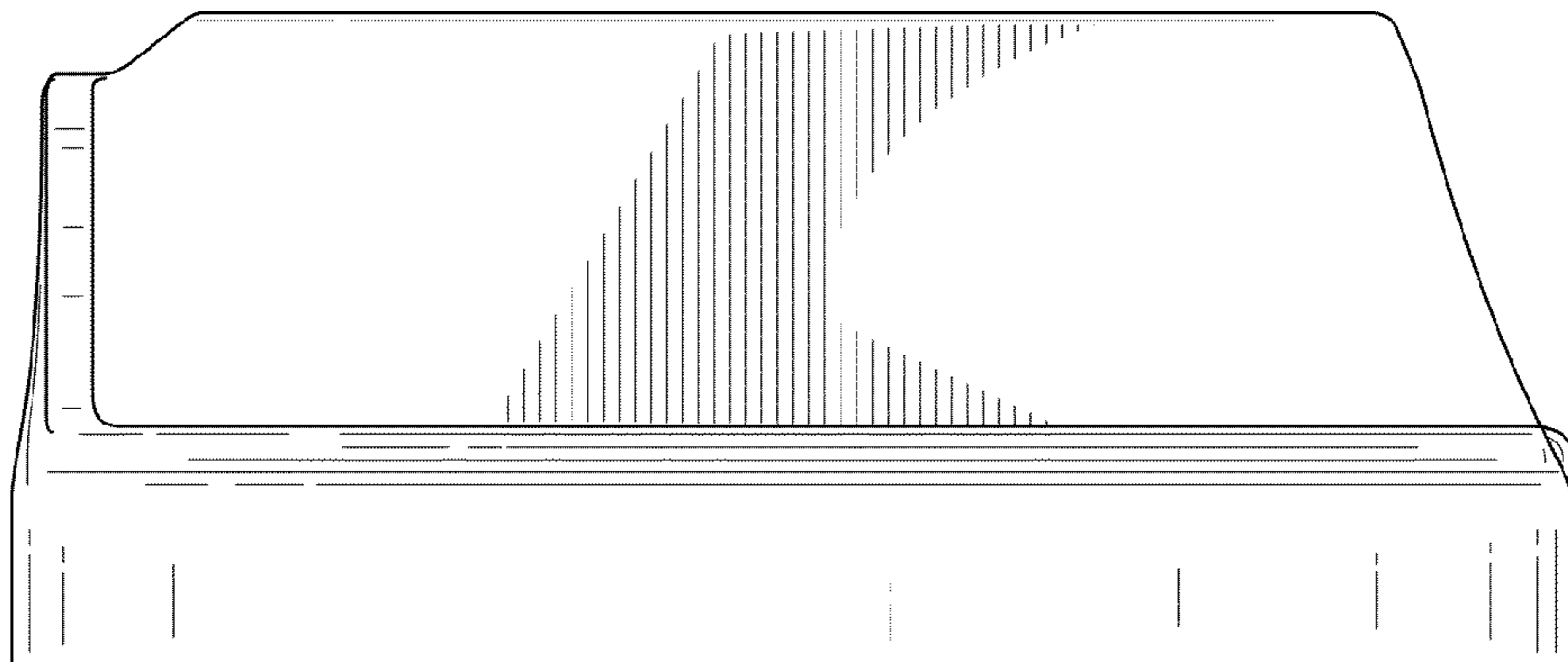

FIG. 5

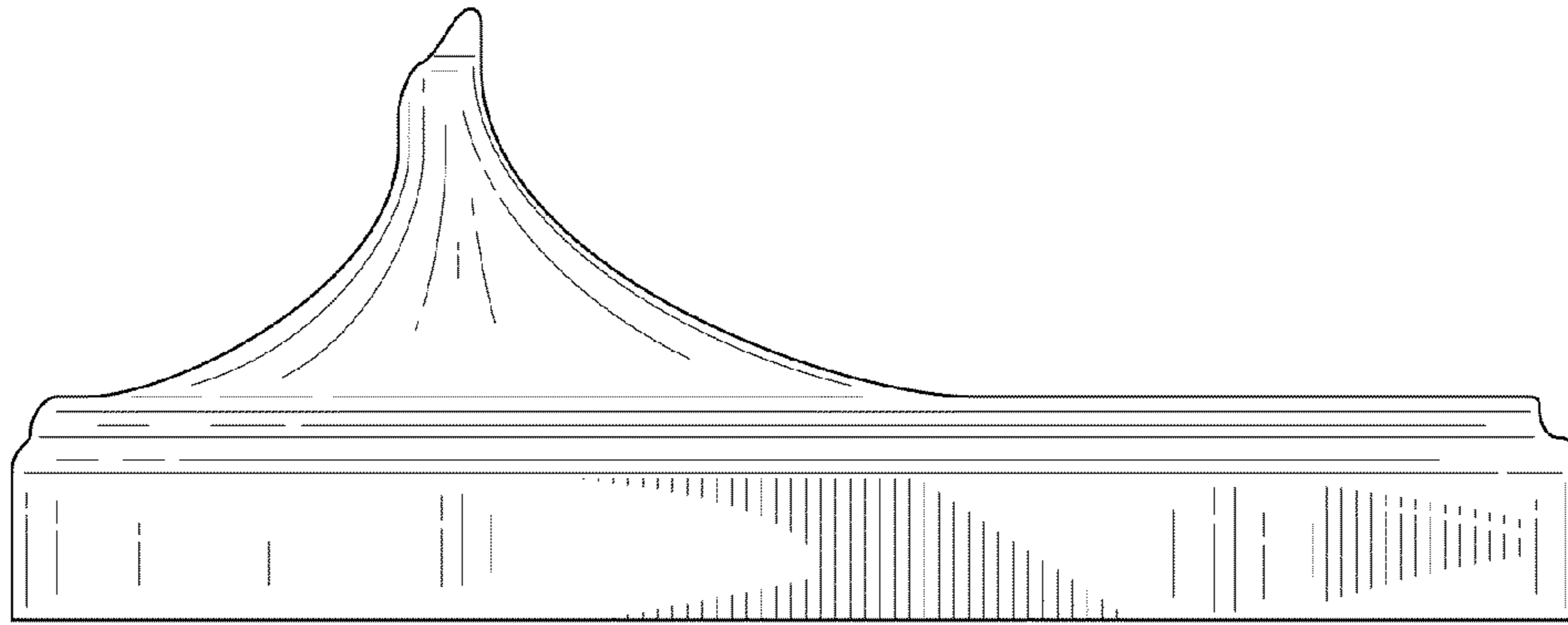

FIG. 6

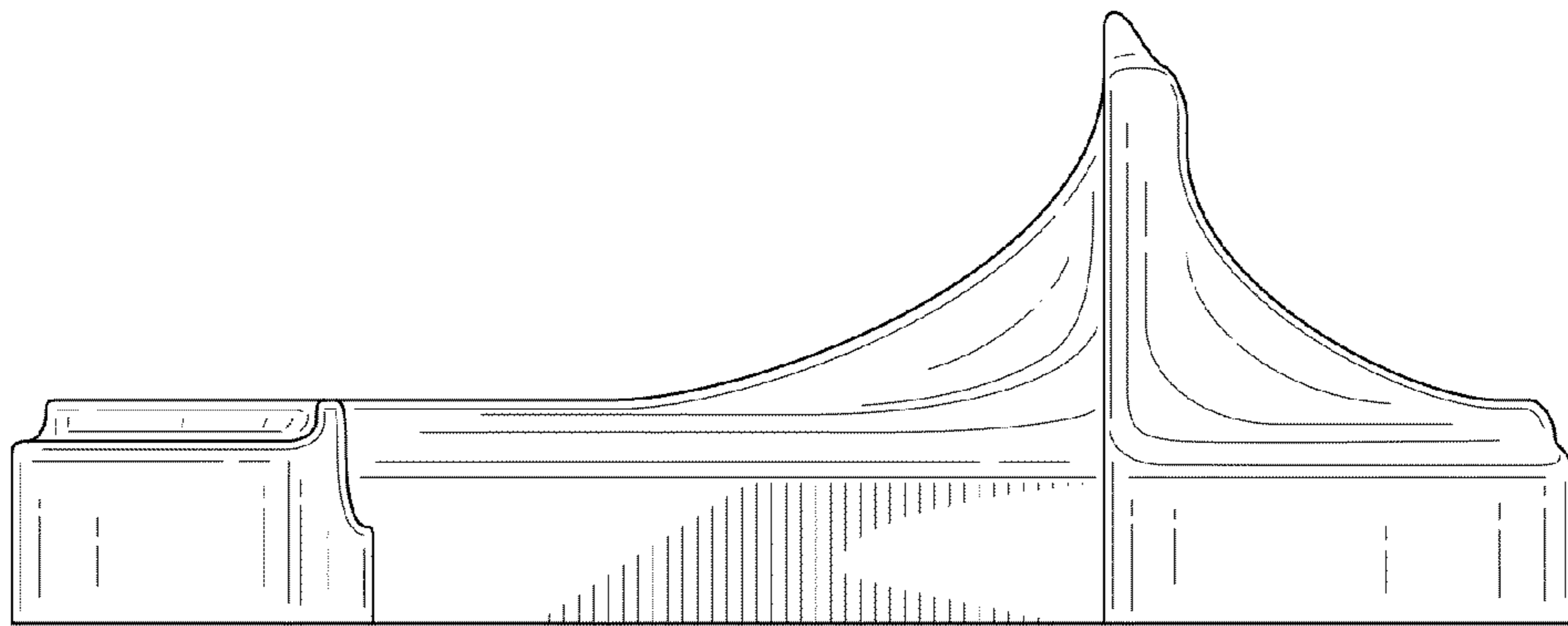

FIG. 7

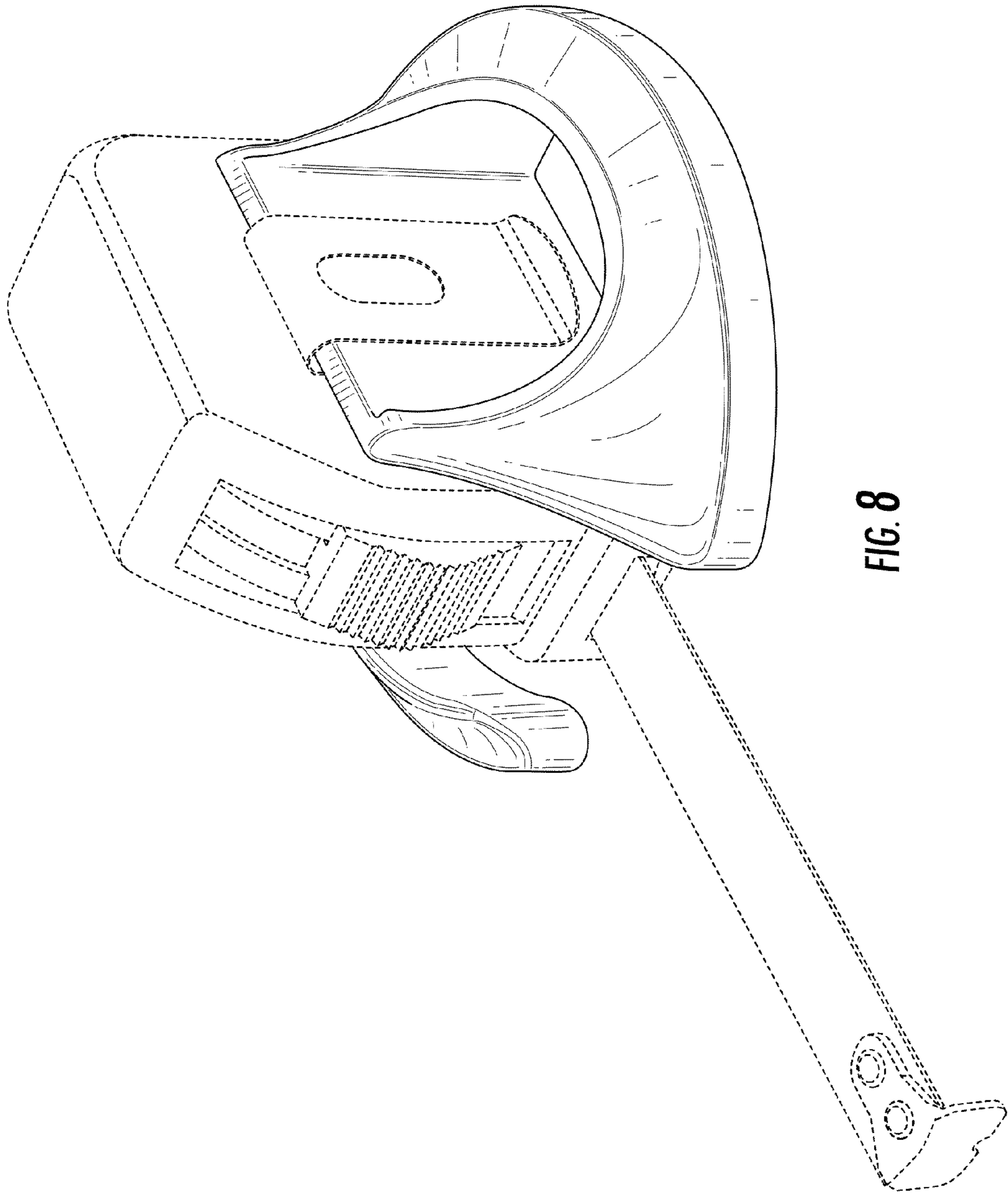

FIG. 8