



US00D741182S

(12) **United States Design Patent**  
**Davis et al.**

(10) **Patent No.:** **US D741,182 S**  
(45) **Date of Patent:** **\*\* Oct. 20, 2015**

(54) **CONTAINER**

(71) Applicant: **Robinsons Soft Drinks Limited**, Hemel Hempstead (GB)

(72) Inventors: **William John Davis**, Bath (GB); **David James McNeill**, Bath (GB)

(73) Assignee: **Robinsons Soft Drinks Limited**, Hemel Hempstead (GB)

(\*\*) Term: **14 Years**

(21) Appl. No.: **29/471,690**

(22) Filed: **Nov. 4, 2013**

(30) **Foreign Application Priority Data**

Aug. 8, 2013 (EM) ..... 002288936

(51) **LOC (10) Cl.** ..... **09-01**

(52) **U.S. Cl.**  
USPC ..... **D9/529**

(58) **Field of Classification Search**

USPC ..... D9/682, 685, 686, 687, 688, 689,  
D9/690-692, 693, 694, 516-548, 549-558,  
D9/559-562, 563-574, 575, 434, 435;  
215/379, 381-384; D7/507-511;  
D24/197; D3/202

CPC ..... B65D 2501/0081; B65D 39/0023;  
B65D 39/0052; B65D 11/02

See application file for complete search history.

(56) **References Cited**

**U.S. PATENT DOCUMENTS**

D71,162 S 9/1926 Smith  
D101,011 S 8/1936 Scurlock

(Continued)

**OTHER PUBLICATIONS**

Photograph of "Crystal Light Liquid," which was on sale in the U.S. prior to Nov. 4, 2013 (1 page).

(Continued)

*Primary Examiner* — Cynthia Ramirez

*Assistant Examiner* — Gino Golan

(74) *Attorney, Agent, or Firm* — Nixon Peabody LLP

(57) **CLAIM**

The ornamental design for container, as shown and described.

**DESCRIPTION**

FIG. 1 is a perspective view of a first embodiment of a container showing our new design.

FIG. 2 is a front elevation view of the container of FIG. 1.

FIG. 3 is a back elevation view of the container of FIG. 1.

FIG. 4 is a first side elevation view of the container of FIG. 1.

FIG. 5 is a second side elevation view of the container of FIG. 1.

FIG. 6 is a top plan view of the container of FIG. 1.

FIG. 7 is a bottom plan view of the container of FIG. 1.

FIG. 8 is a perspective view of a second embodiment of a container showing our new design.

FIG. 9 is a front elevation view of the container of FIG. 8.

FIG. 10 is a back elevation view of the container of FIG. 8.

FIG. 11 is a first side elevation view of the container of FIG. 8.

FIG. 12 is a second side elevation view of the container of FIG. 8.

FIG. 13 is a top plan view of the container of FIG. 8; and,

FIG. 14 is a bottom plan view of the container of FIG. 8.

The portions of the drawings shown in broken lines represent environmental structure and form no part of the claimed design.

**1 Claim, 10 Drawing Sheets**

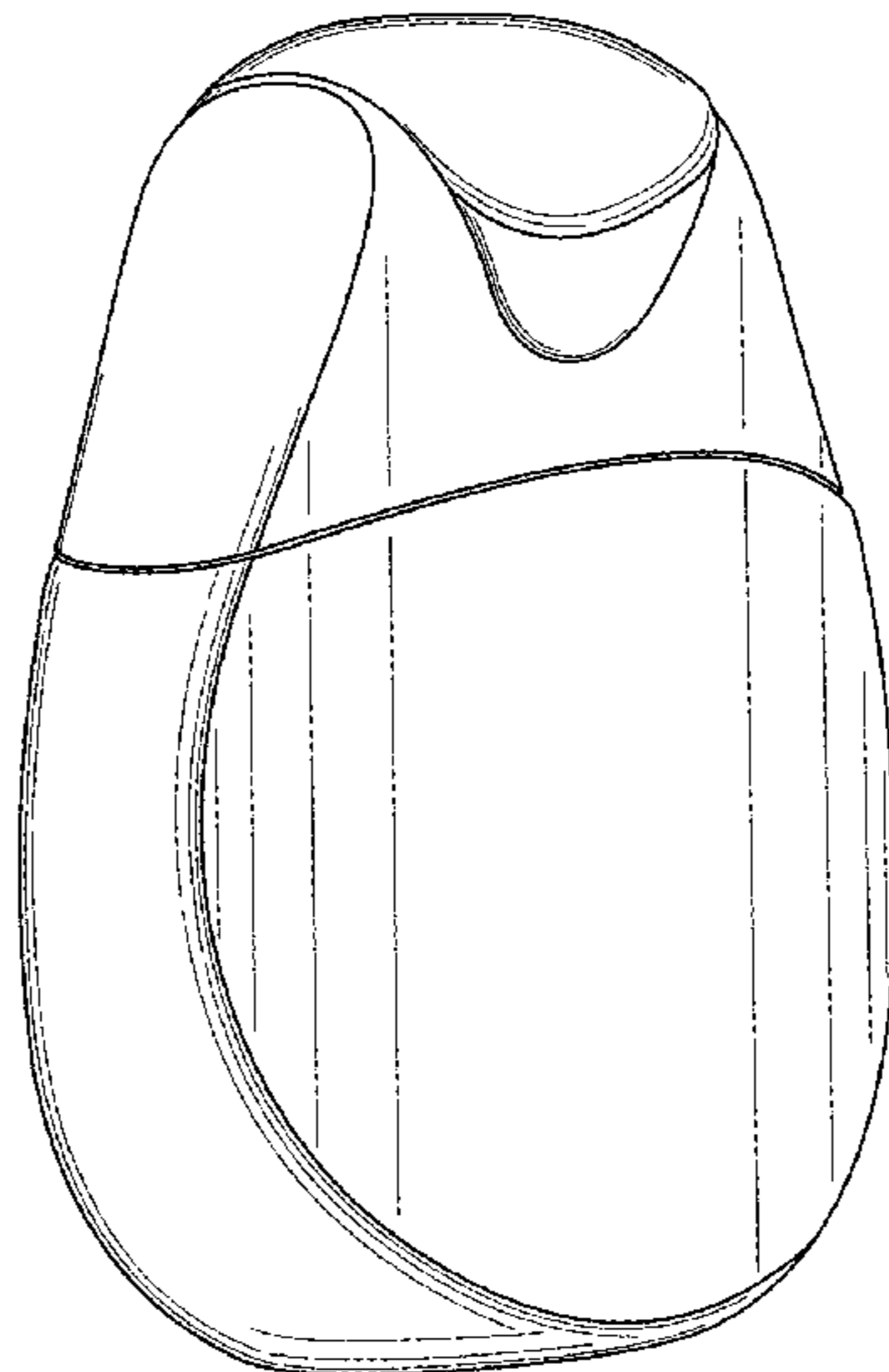

(56)

References Cited

U.S. PATENT DOCUMENTS

D202,662 S 10/1965 Williams  
 D240,829 S 8/1976 Jones et al.  
 D247,348 S 2/1978 Grodin  
 D259,095 S 5/1981 Benedict  
 D279,077 S 6/1985 Drummond, Jr. et al.  
 5,038,974 A 8/1991 DaCosta  
 D322,754 S 12/1991 Halm  
 D328,865 S 8/1992 Crawford  
 D336,614 S 6/1993 Crawford  
 D343,361 S 1/1994 More  
 D347,389 S 5/1994 Crawford  
 D349,058 S 7/1994 Farce  
 D367,004 S 2/1996 Herbst et al.  
 D383,972 S \* 9/1997 Weiss ..... D9/686  
 D391,855 S 3/1998 Fenton et al.  
 D414,117 S 9/1999 Mikla  
 D428,579 S 7/2000 Waitzenegger  
 D438,459 S 3/2001 Holthaus  
 D447,953 S 9/2001 Brynstad et al.  
 D463,744 S 10/2002 Brozell  
 D463,747 S 10/2002 Peon et al.  
 D471,818 S 3/2003 Weber  
 D482,286 S 11/2003 Samson et al.  
 D486,065 S 2/2004 Hutchinson et al.  
 D498,415 S 11/2004 Schuller et al.  
 D527,640 S 9/2006 Cummings et al.  
 D533,966 S \* 12/2006 Bakic ..... D28/76  
 D536,253 S 2/2007 Howes et al.  
 D538,668 S 3/2007 Campbell et al.  
 D540,188 S \* 4/2007 Karussi et al. .... D9/734  
 D541,161 S \* 4/2007 Ames ..... D9/529  
 D542,141 S 5/2007 Okin et al.  
 D544,351 S 6/2007 Dittmer et al.  
 D547,190 S 7/2007 Kuzma et al.  
 D574,246 S 8/2008 Russell et al.  
 D580,767 S 11/2008 Okin et al.  
 D581,794 S 12/2008 Haubert, III et al.  
 D585,290 S 1/2009 Toh  
 D587,117 S 2/2009 Crawford  
 D588,459 S 3/2009 Davis et al.  
 D588,460 S 3/2009 Davis et al.  
 D588,461 S 3/2009 Davis et al.  
 D588,462 S 3/2009 Davis et al.  
 D590,264 S 4/2009 Schwartz et al.  
 D592,957 S 5/2009 Davis et al.  
 D598,753 S 8/2009 Schwartz et al.

D601,899 S 10/2009 Davis et al.  
 D601,907 S \* 10/2009 Gainey et al. .... D9/563  
 D602,356 S 10/2009 Shurtleff et al.  
 D608,647 S 1/2010 Toh et al.  
 D609,098 S 2/2010 Almstead, Jr. et al.  
 D610,022 S 2/2010 Kanfer et al.  
 D614,024 S \* 4/2010 Eason et al. .... D9/421  
 D623,054 S \* 9/2010 Eason et al. .... D9/421  
 D628,490 S 12/2010 Sato et al.  
 D638,713 S 5/2011 de Cleir et al.  
 D638,714 S 5/2011 de Cleir et al.  
 D638,715 S 5/2011 Albaum et al.  
 D644,516 S \* 9/2011 Howell et al. .... D9/521  
 D644,517 S \* 9/2011 Howell et al. .... D9/521  
 D644,518 S \* 9/2011 Howell et al. .... D9/521  
 D644,519 S \* 9/2011 Howell et al. .... D9/521  
 D644,520 S \* 9/2011 Howell et al. .... D9/521  
 D644,524 S \* 9/2011 Howell et al. .... D9/521  
 D644,529 S \* 9/2011 Padain et al. .... D9/529  
 D644,530 S \* 9/2011 Padain et al. .... D9/529  
 D644,531 S \* 9/2011 Padain et al. .... D9/529  
 D645,734 S \* 9/2011 Eason et al. .... D9/421  
 D650,686 S 12/2011 de Cleir et al.  
 D651,903 S 1/2012 Teller  
 D661,994 S 6/2012 Van Den Wouwer et al.  
 D666,103 S 8/2012 Blachford et al.  
 D677,572 S \* 3/2013 Papiernik ..... D9/529  
 D677,573 S \* 3/2013 Papiernik ..... D9/529  
 8,511,472 B2 8/2013 Dupuis et al.  
 D690,202 S \* 9/2013 Beck et al. .... D9/529  
 2007/0023453 A1 2/2007 Simkins  
 2007/0102455 A1 5/2007 Stark et al.  
 2007/0253761 A1 11/2007 May

OTHER PUBLICATIONS

Photograph of "Dasani Drops," which was on sale in the U.S. prior to Nov. 4, 2013 (1 page).  
 Photograph of "Kook-Aid Liquid," which was on sale in the U.S. prior to Nov. 4, 2013 (1 page).  
 Photograph of "Market Pantry Liquid Water Enhancer," which was on sale in the U.S. prior to Nov. 4, 2013 (1 page).  
 Photograph of "Nestea Liquid Water Enhancer," which was on sale in the U.S. prior to Nov. 4, 2013 (1 page).  
 Photograph of "Powerade Zero Drops," which was on sale in the U.S. prior to Nov. 4, 2013 (1 page).  
 Photographs of "Mio Liquid Water Enhancer," which was on sale in the U.S. prior to Nov. 4, 2013 (1 page).

\* cited by examiner

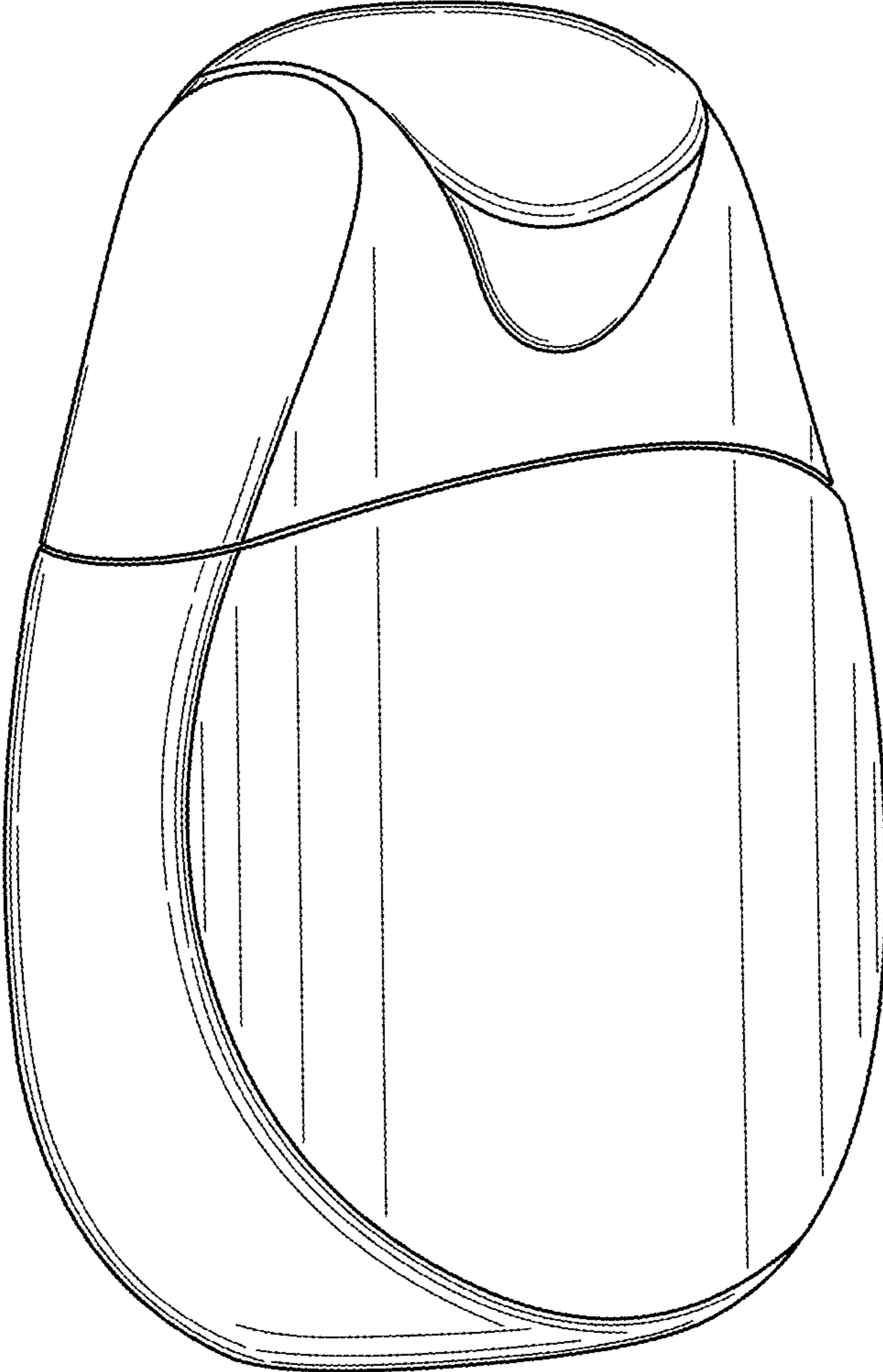

Fig. 1

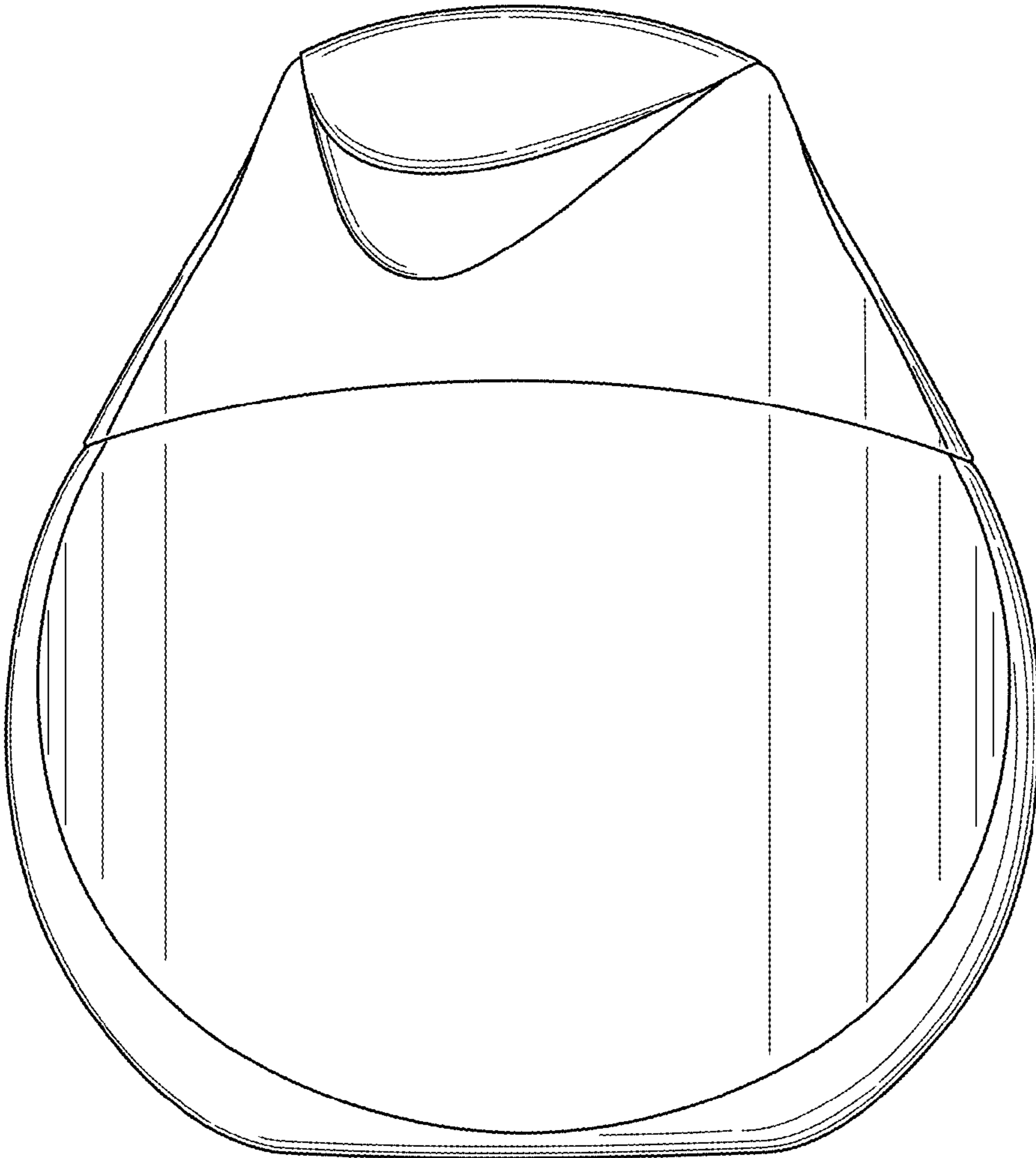

Fig. 2



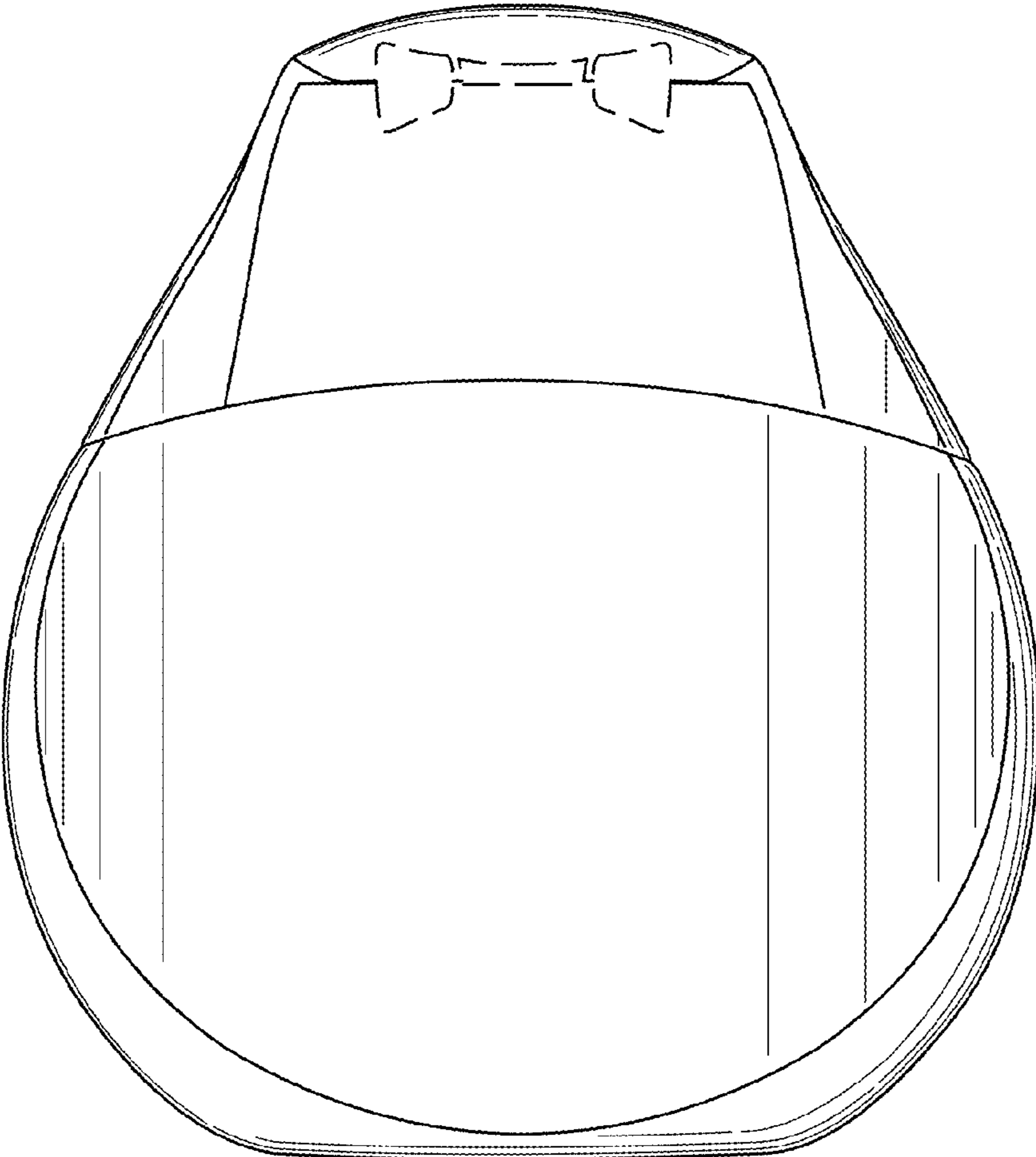

Fig. 3

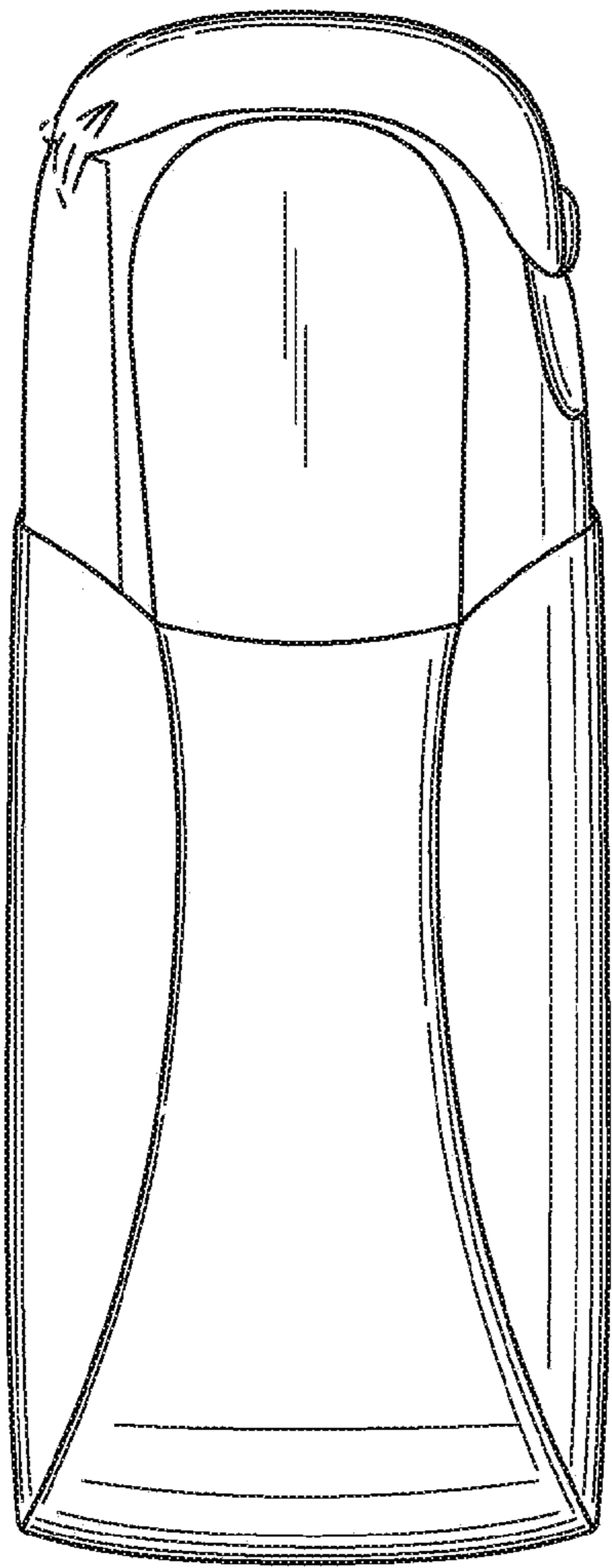

Fig. 4

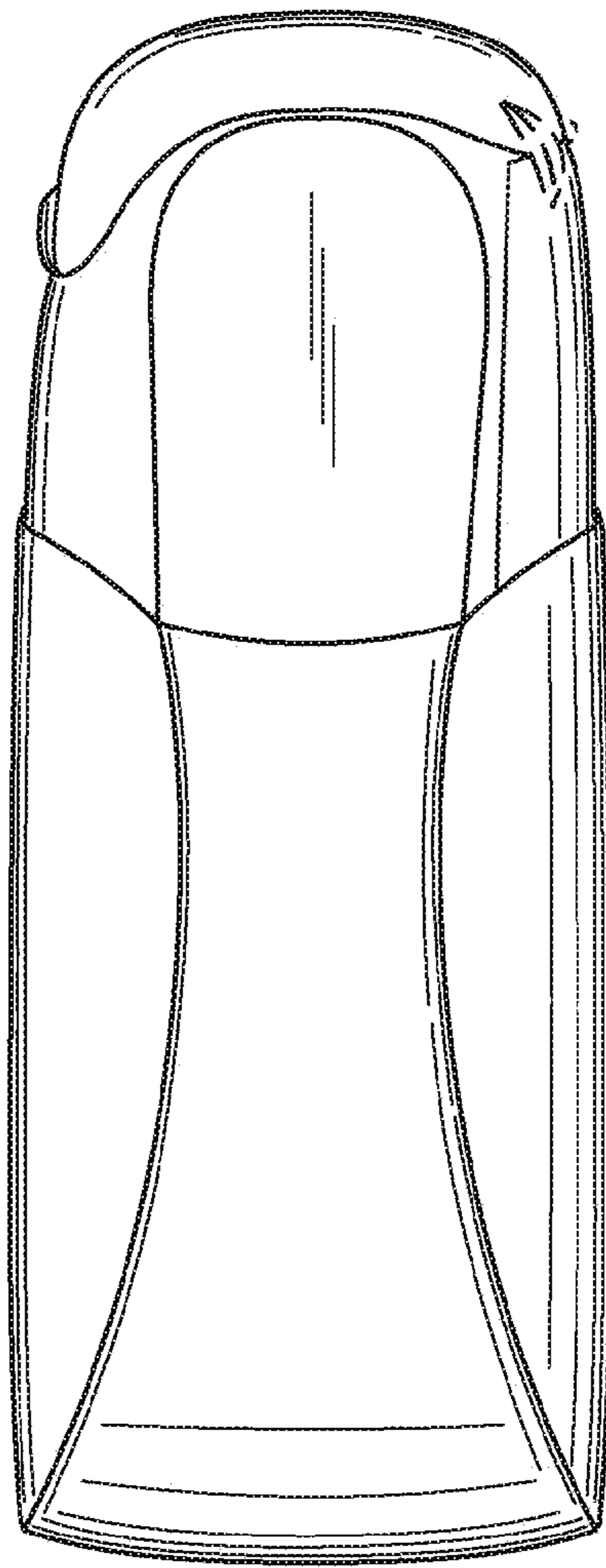

Fig. 5

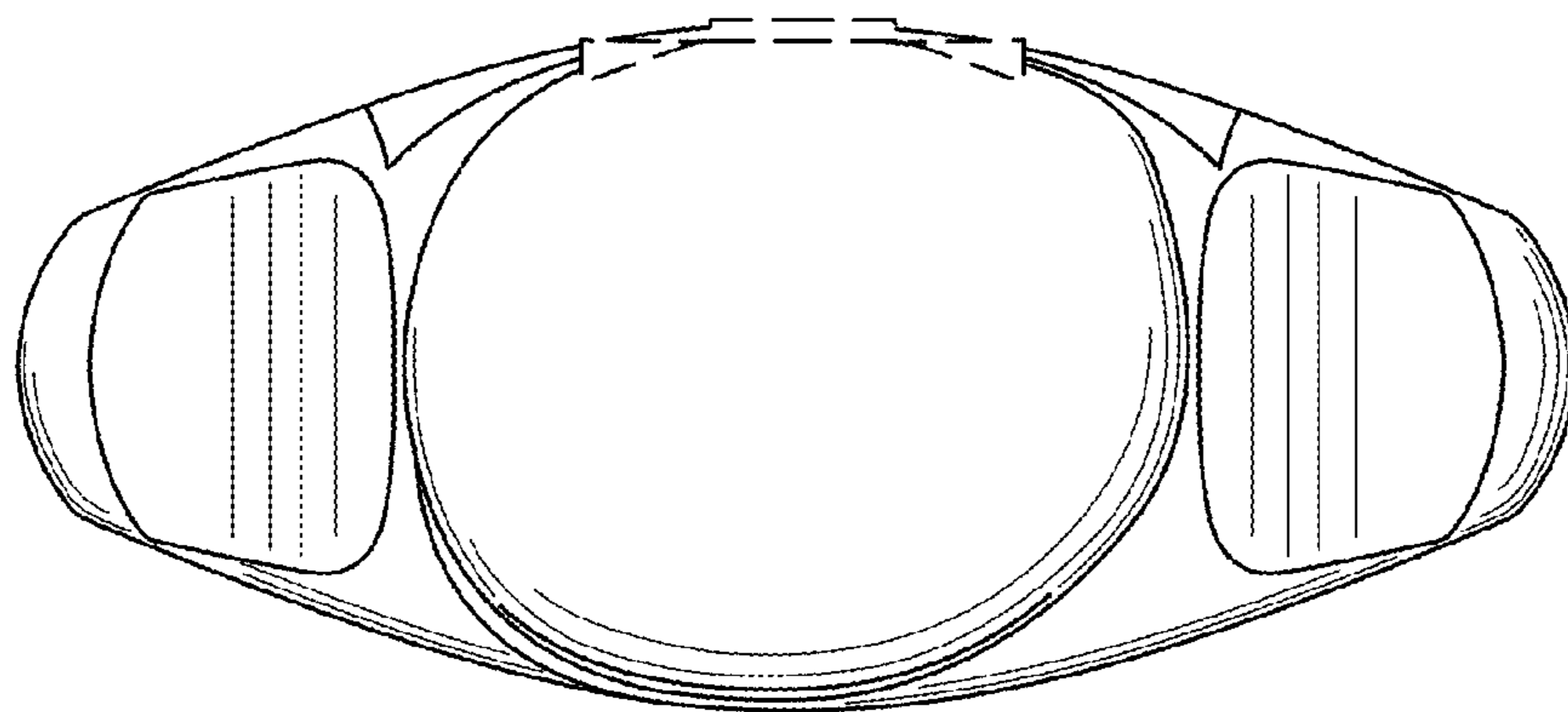

Fig. 6

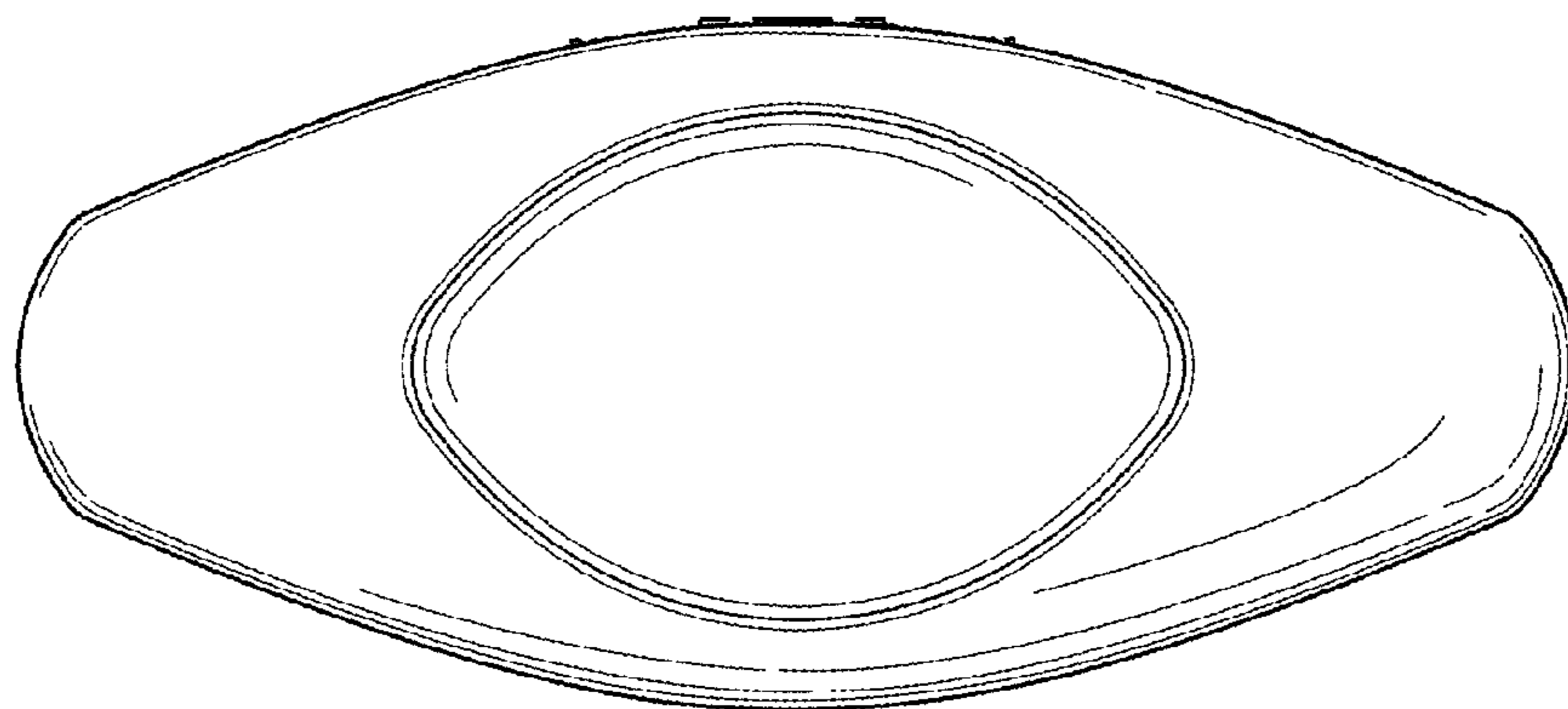

Fig. 7

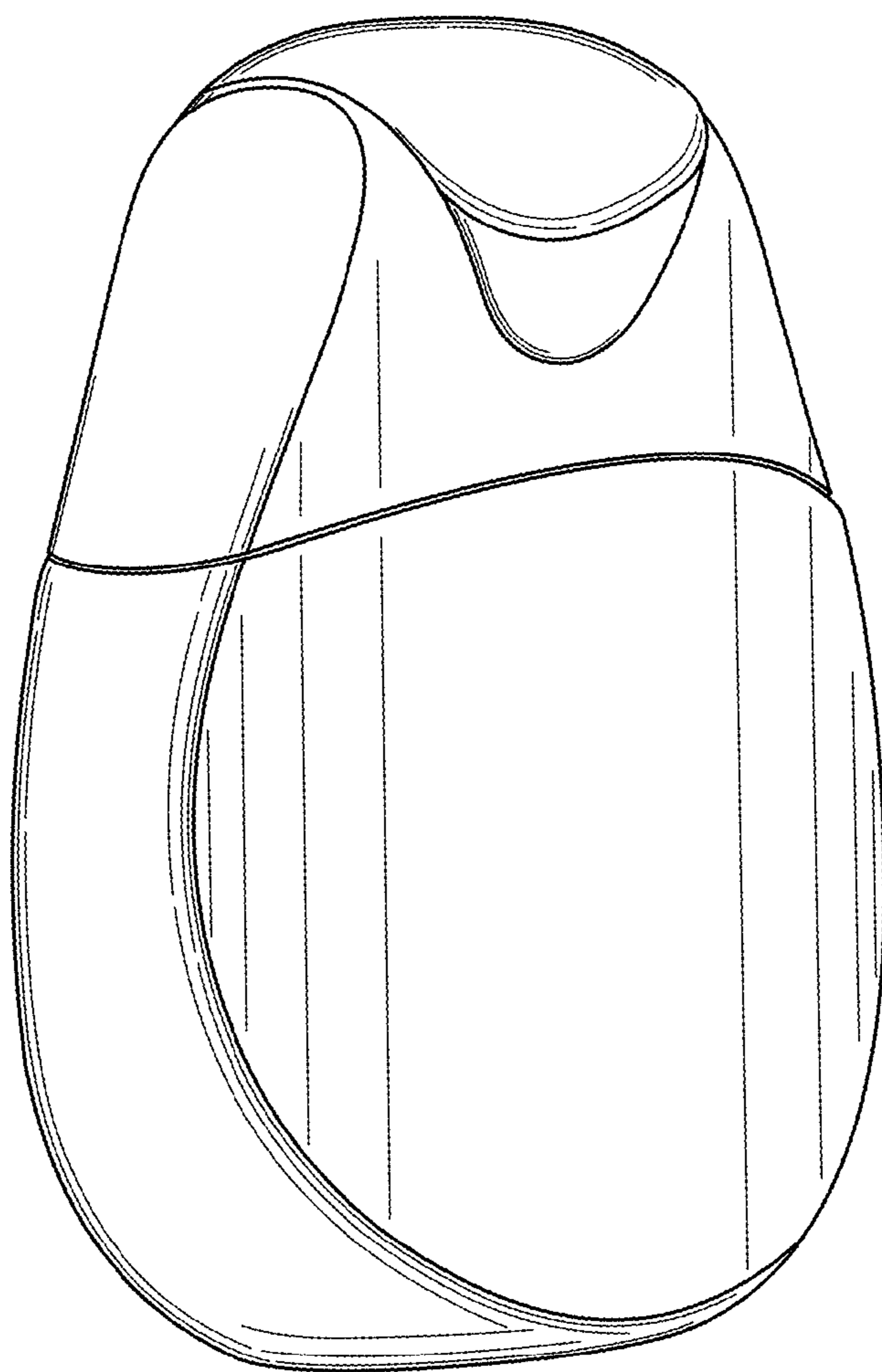

Fig. 8



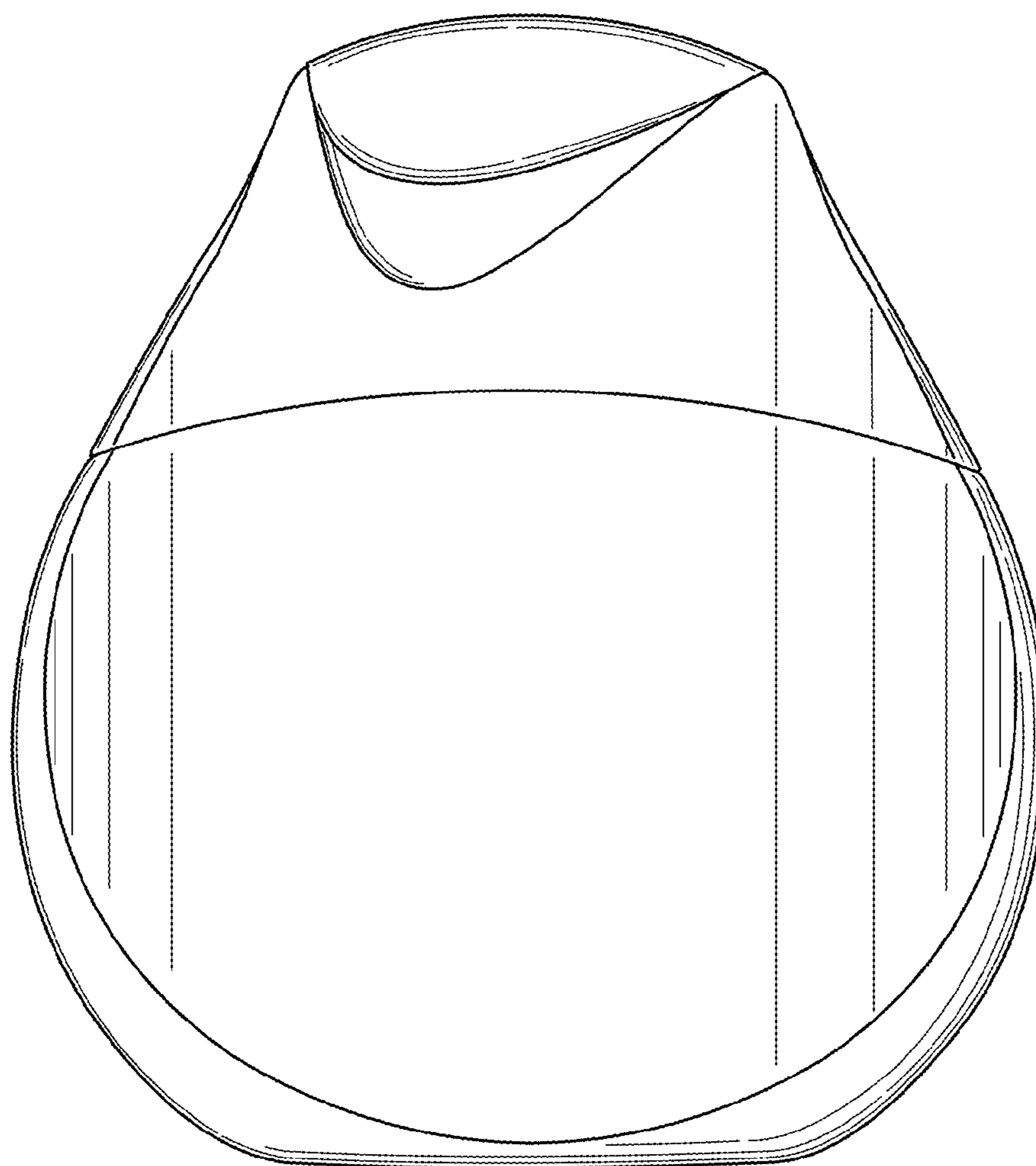

Fig. 9

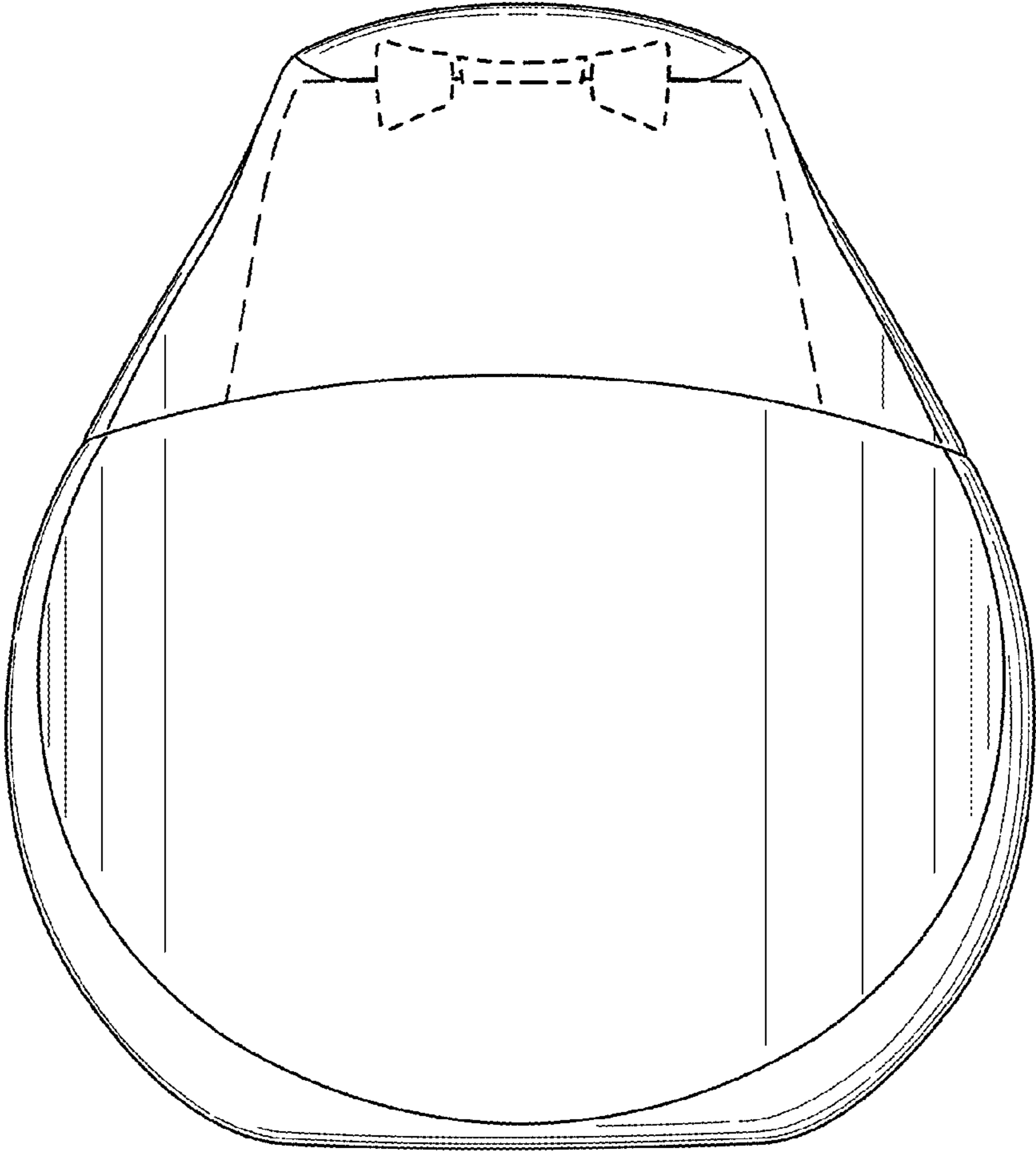

Fig. 10

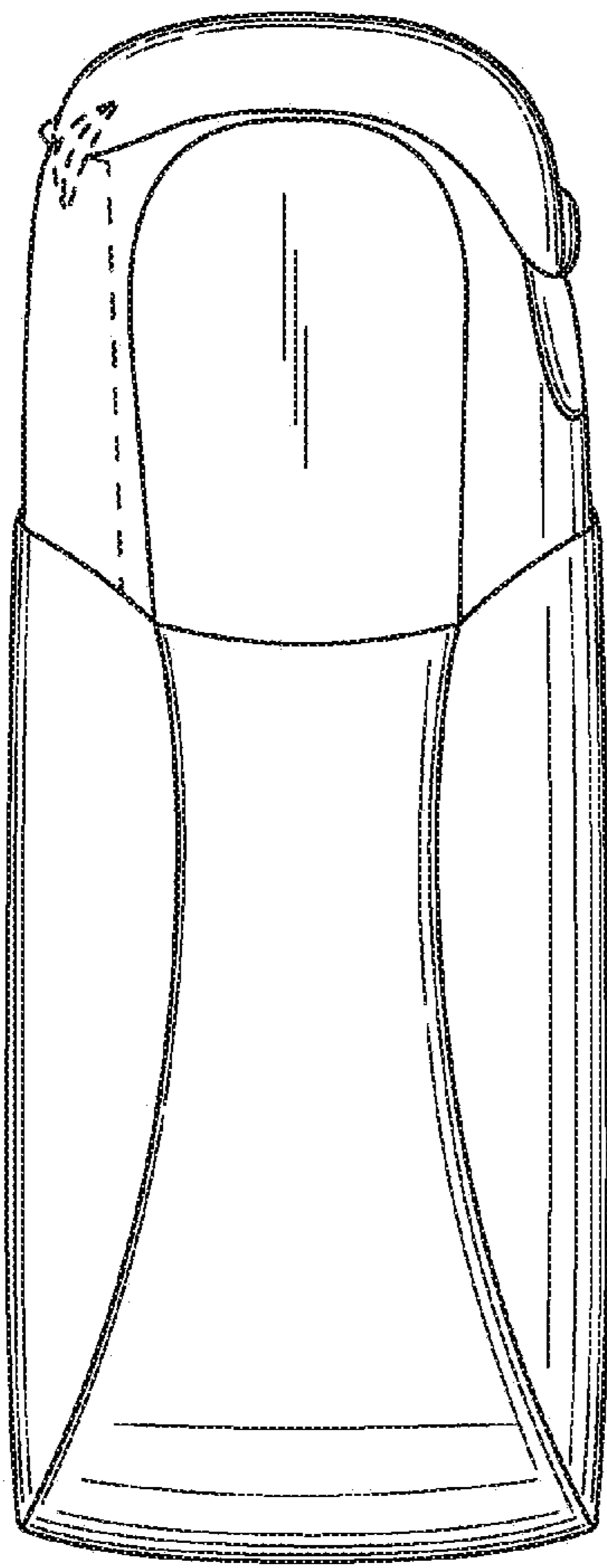

Fig. 11

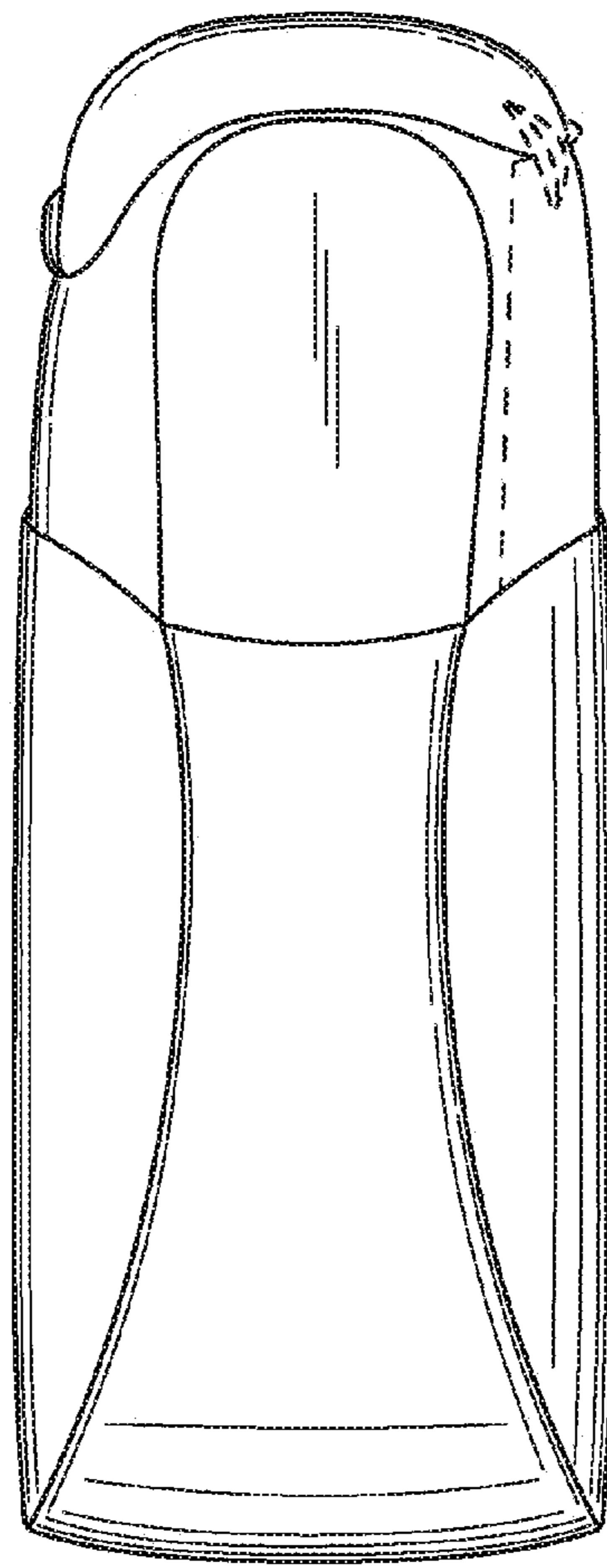

Fig. 12

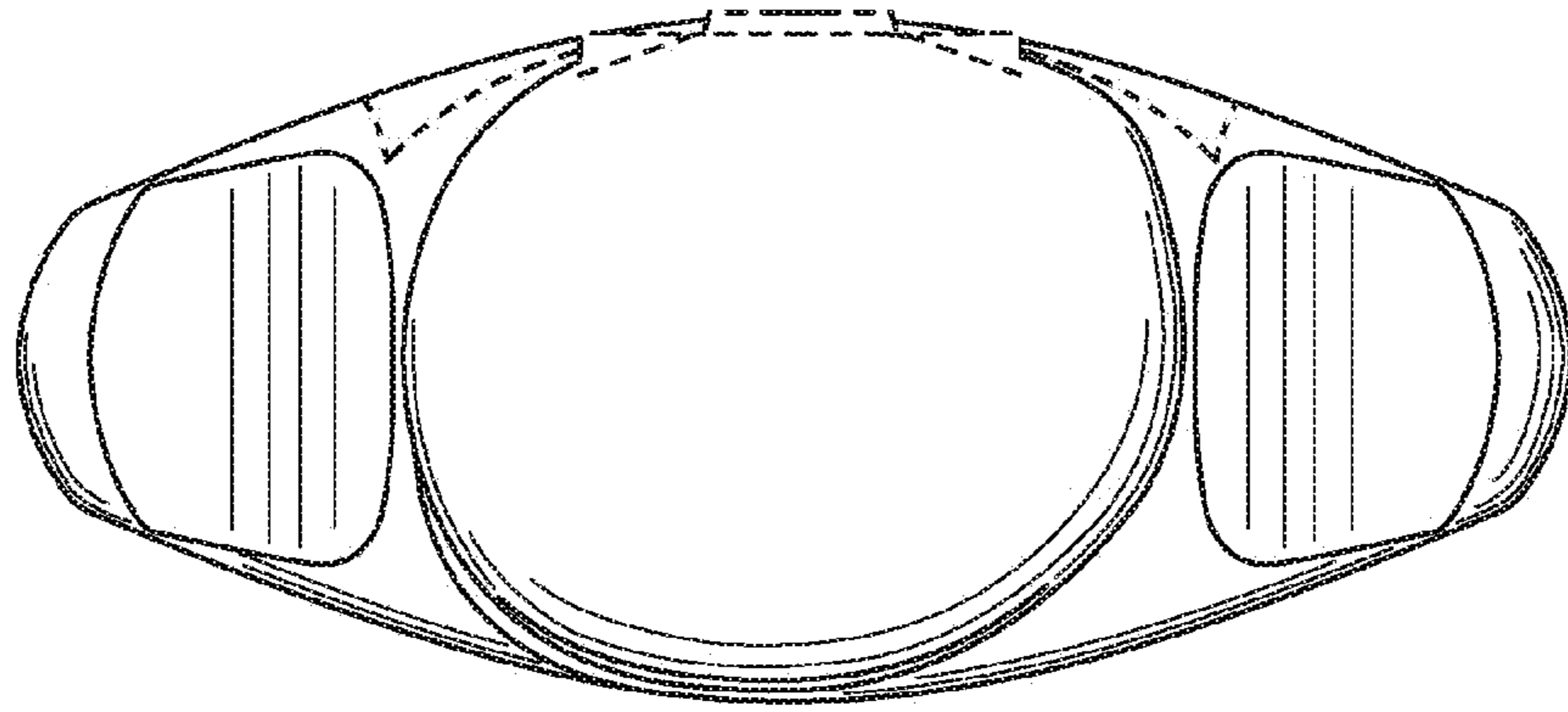

Fig. 13

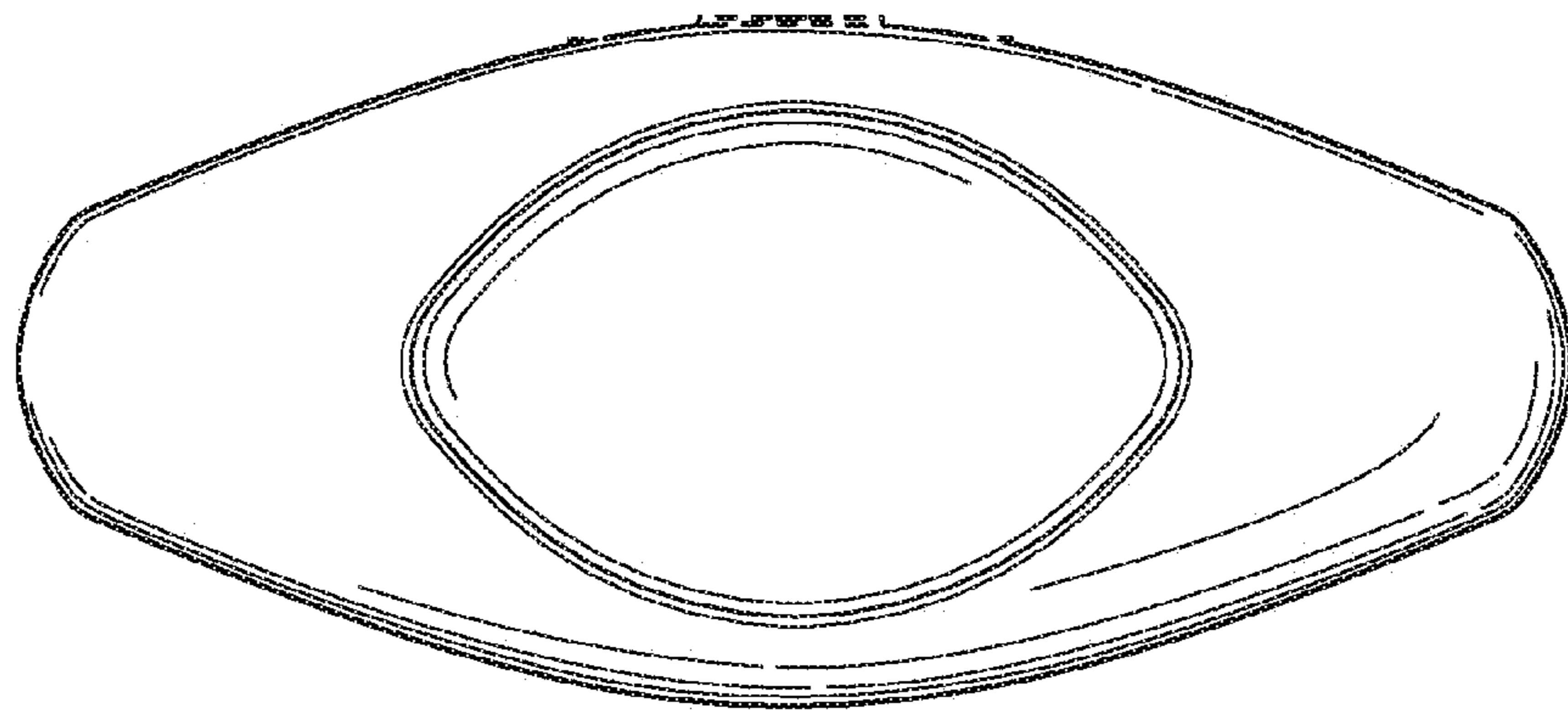

Fig. 14