



US00D741138S

(12) **United States Design Patent**
Wong

(10) **Patent No.:** **US D741,138 S**
(45) **Date of Patent:** **** Oct. 20, 2015**

(54) **HAND-HELD SANDING IMPLEMENT**

(76) Inventor: **Kwai Sun Oliver Wong**, Baulkham Hills (AU)

(**) Term: **14 Years**

(21) Appl. No.: **29/425,846**

(22) Filed: **Jun. 27, 2012**

(51) **LOC (10) Cl.** **08-05**

(52) **U.S. Cl.**
USPC **D8/90**

(58) **Field of Classification Search**

USPC D8/14, 62, 70, 90–94, 107, 303;
D28/58, 59; D32/46, 48, 49, 52;
15/236, 236.01, 244.1; 451/522–525,
451/540
CPC A45D 29/05; A45D 29/14; A47L 13/08;
B24B 23/028; B24B 23/04; B25F 5/006;
B25F 5/02; B44D 3/164; G05G 1/02; G05G
1/06; G05G 5/06

See application file for complete search history.

(56) **References Cited**

U.S. PATENT DOCUMENTS

D216,419 S * 1/1970 Slany D8/62
D217,427 S * 5/1970 Slany D8/62
4,481,689 A * 11/1984 Westmoreland 15/236.01
D343,104 S * 1/1994 Hoshino D8/62
5,491,896 A * 2/1996 Stolzer et al. 30/169
D598,727 S * 8/2009 Carlton D8/90
2007/0295521 A1* 12/2007 Wiker et al. 173/162.1
2009/0104861 A1* 4/2009 Van Der Linde et al. 451/344

2011/0226268 A1* 9/2011 Filonczuk 132/73.6

* cited by examiner

Primary Examiner — Philip S Hyder

Assistant Examiner — Roselynn Cody

(74) *Attorney, Agent, or Firm* — Duane Morris LLP

(57) **CLAIM**

The ornamental design for a hand-held sanding implement, as shown and described.

DESCRIPTION

FIG. 1 is a left side elevational view of the present invention.

FIG. 2 is a right side elevational view thereof.

FIG. 3 is a top plan view thereof.

FIG. 4 is an enlarged rear elevational view thereof.

FIG. 5 is a left front perspective view thereof.

FIG. 6 is a bottom plan view of an enlarged head portion thereof; and,

FIG. 7 is a left side elevational view of an enlarged head portion thereof, the right side being a mirror image.

Certain views have been omitted as duplicative. The right side elevational view of the head portion of the present invention is a mirror image of the left side elevational view of the head portion shown in FIG. 7.

To the extent any surface is not shown or discernible from the other views shown in the figures, it is to be understood that that surface is flat and includes no surface ornamentation. It should be understood that the bottom surfaces are, except as apparent from the views shown in the other figures, flat and include no surface ornamentation.

Broken lines in the drawings illustrate features of the hand-held sanding implement that form no part of the claim.

1 Claim, 7 Drawing Sheets

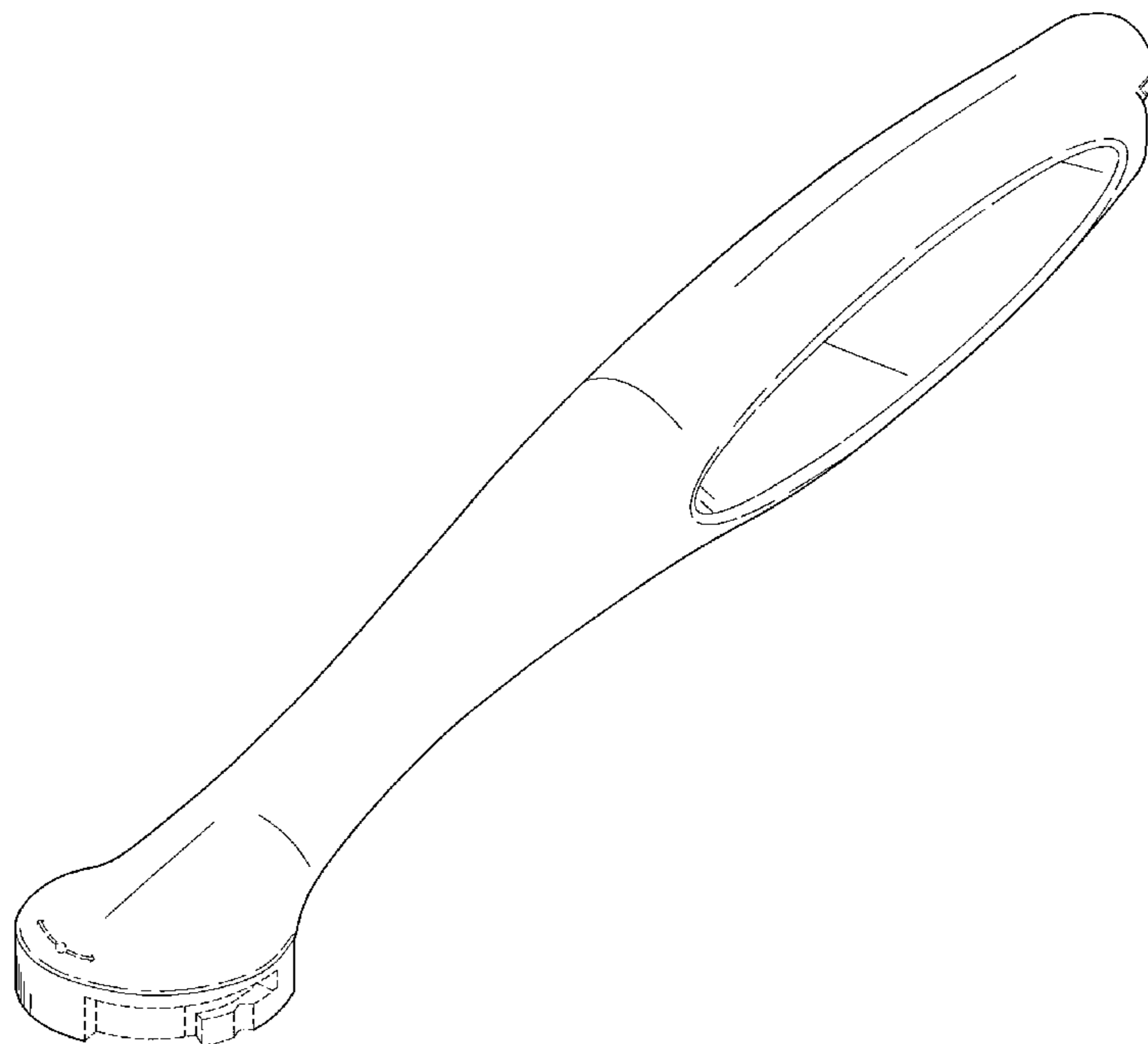

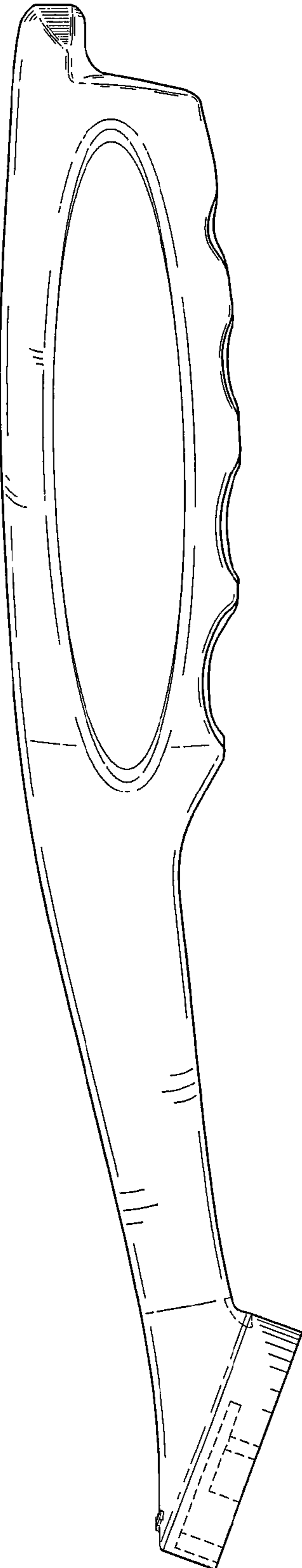

FIG. 1

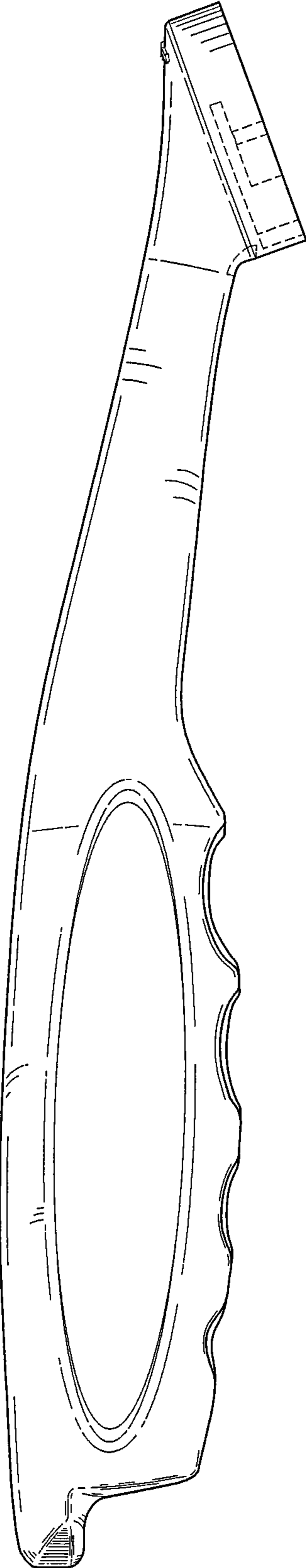

FIG. 2

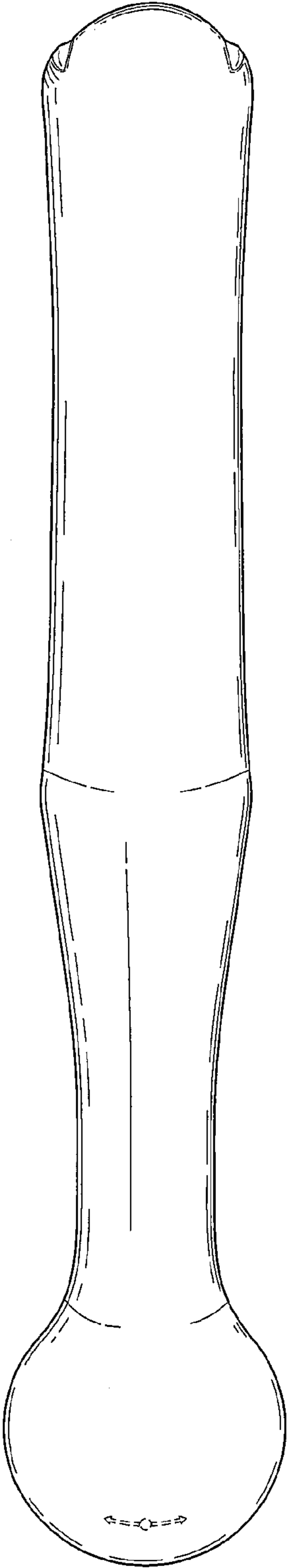

FIG. 3

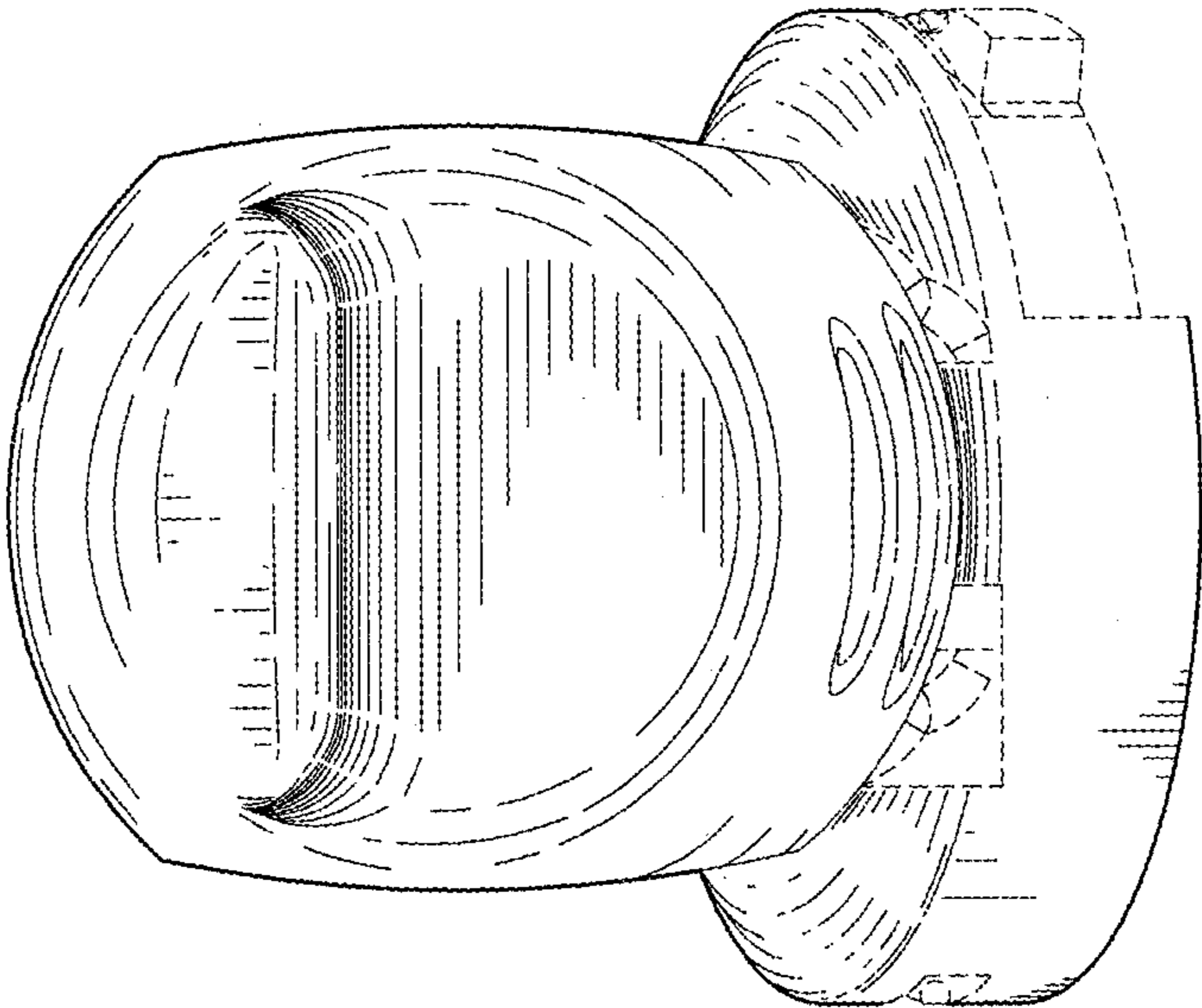

FIG. 4

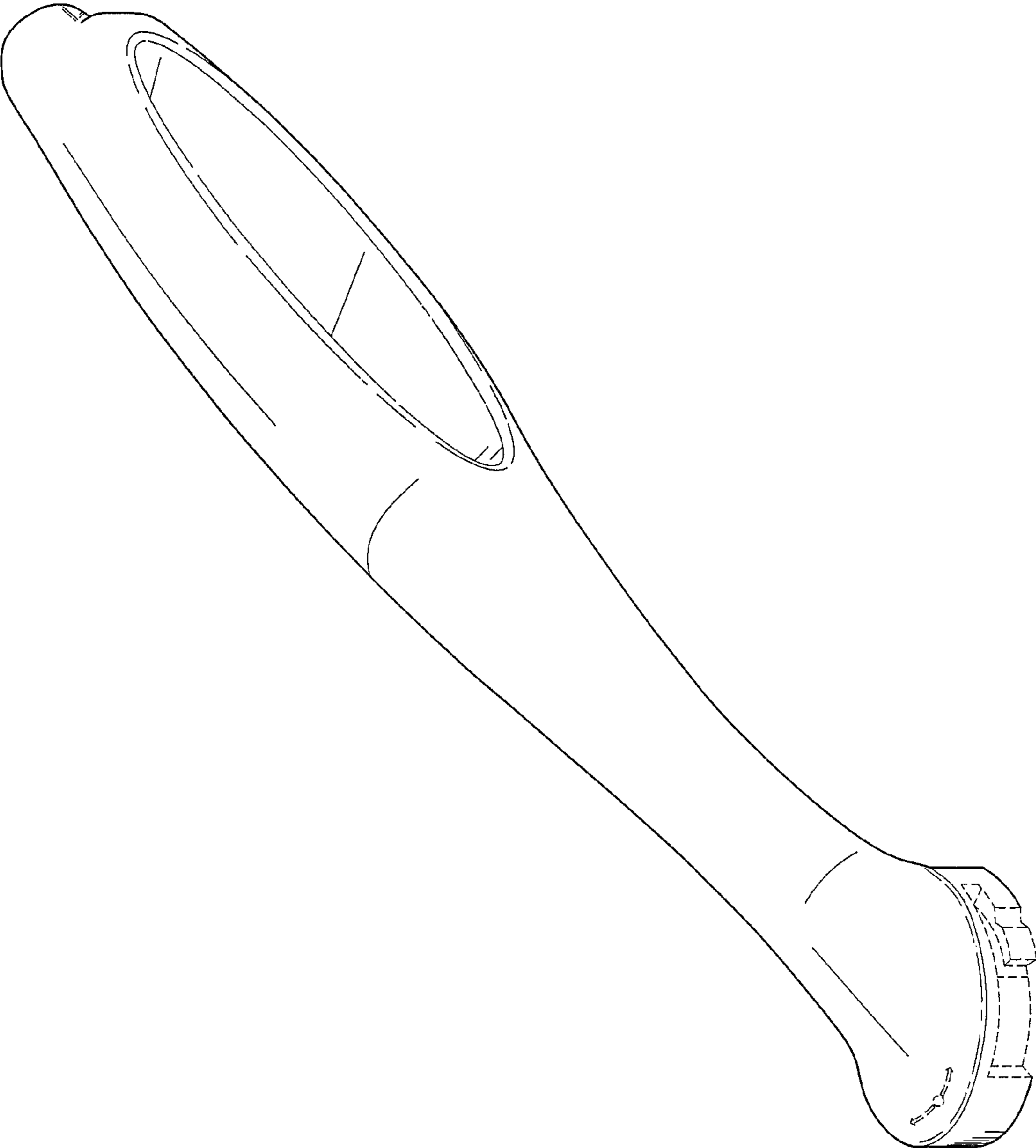

FIG. 5

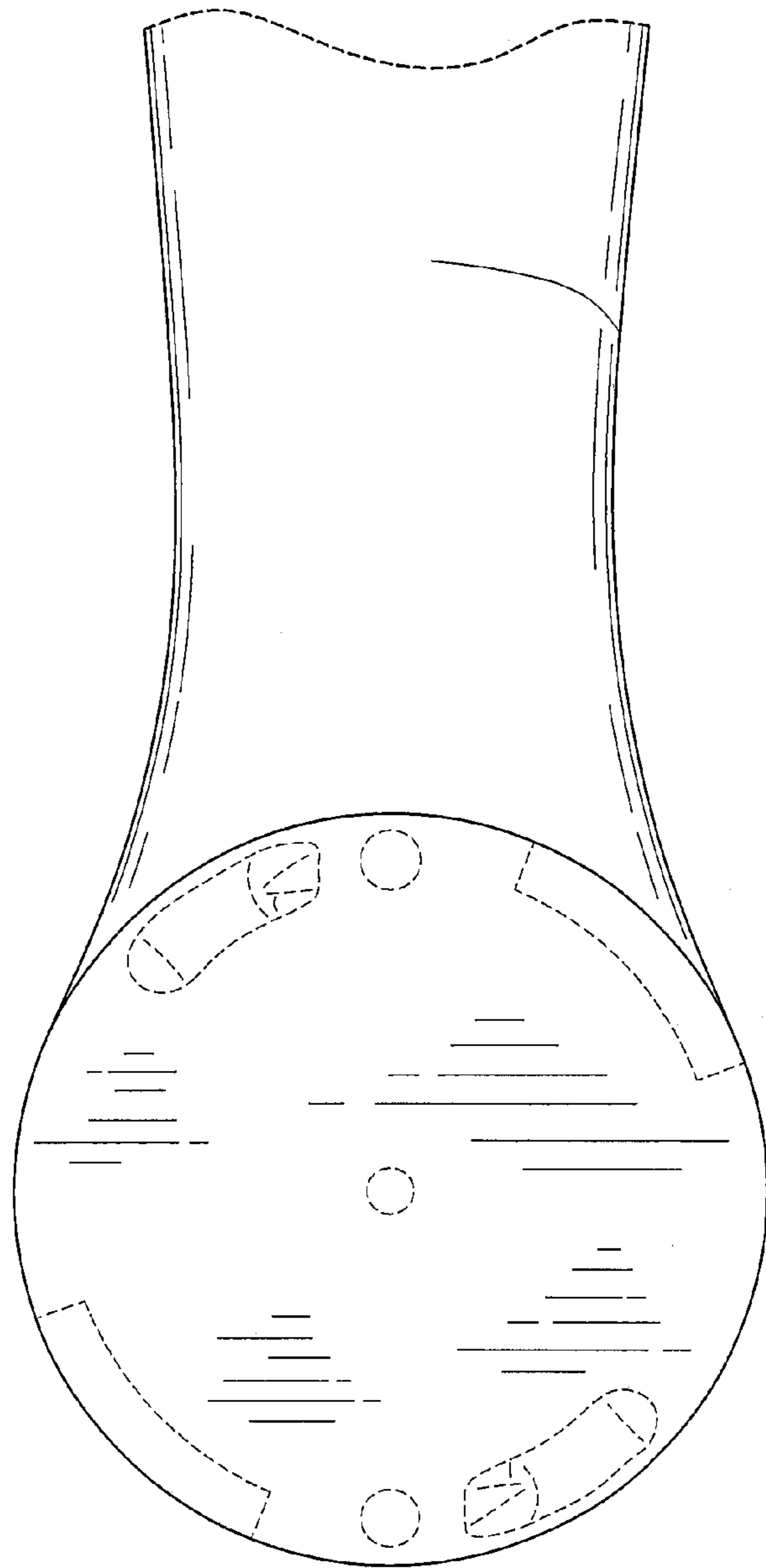

FIG. 6

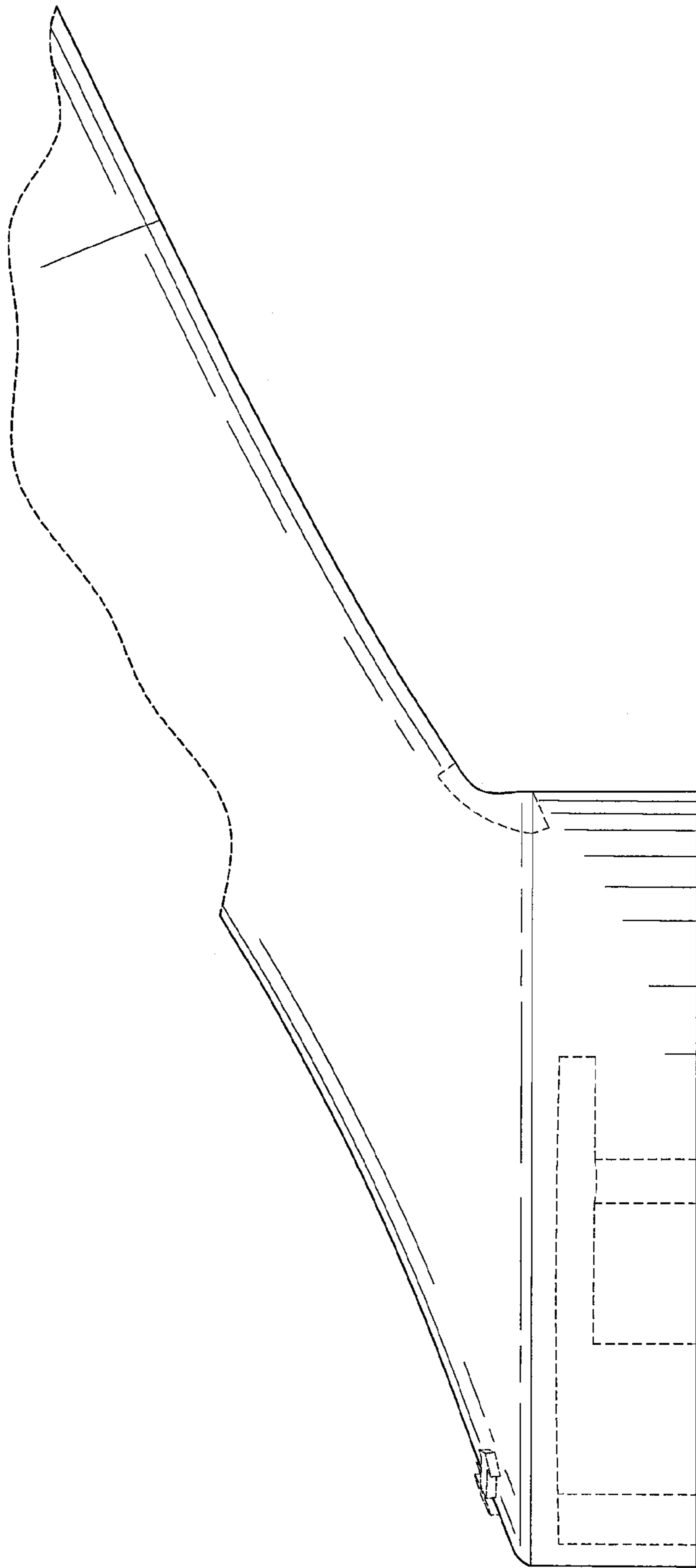

FIG. 7